

Oxley Interconnect Catalogue

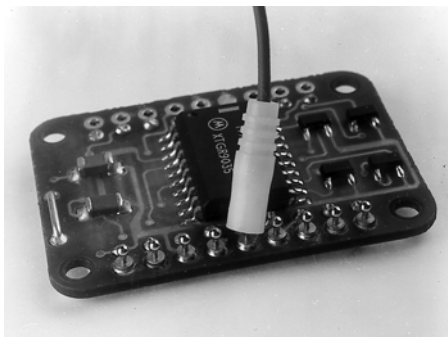

Oxley is an established design and manufacturer of quality electronic components.

We meet customer requirements with a complete range of standard electrical components for interconnection, as well as offering clients custom design and manufacturing facilities for non-standard solutions.

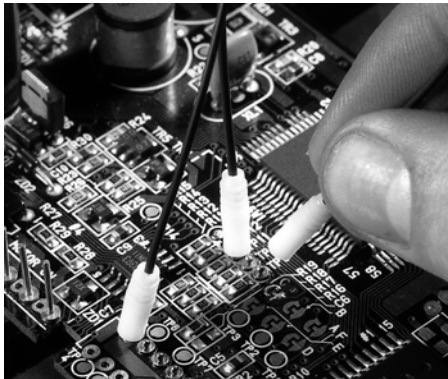



We offer a wide range of surface mount and through hole interconnect products off-the-shelf for use in electronic applications:

- Surface Mount PCB Test Points
- Through Hole PCB Test Points
- Through Hole PCB Connectors
- Chassis Mounted Insulated Terminals and Feedthroughs
- Chassis Mounted and In Line Insulated Plugs and Sockets
- Custom Interconnection

In addition, we offer a sub contract precision machining service to produce tight toleranced turned parts including those made from speciality materials such as Alumel and Chromel. Parts can be supplied in a wide variety of plating finishes to various standards.

In terms of design, production and Quality Assurance procedures, the Oxley high standard has been recognised by National Approvals for manufacture and research to BS EN ISO 9001: 2000, BS9000 and IECQ-CECC.

Selection Guide

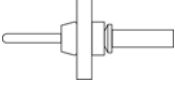
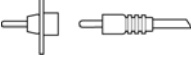
Types	Features	Page
SMOX Surface Mount Test points 	<ul style="list-style-type: none"> available either loose or taped and reeled. requires minimum pad size of only 2 mm diameter. unique retention mechanism prevents damage to PCB during connection/disconnection of socket. 	3
KINKY PIN PTH Connectors 	<ul style="list-style-type: none"> designed for plated through hole applications. insertion tools available for hand and semi-automatic insertion. custom styles available. 	7
Snale Printed Circuit Connectors 	<ul style="list-style-type: none"> self-retention mechanism provides high retention and rigidity. custom styles available. Snaplox, holed and test-point styles available. 	12
SNAPLOX Printed Circuit Test Point 	<ul style="list-style-type: none"> award winning design allows rapid connection/disconnection. self-retaining and straight shank designs available. suitable for chassis, PCB and ceramic hybrids. 	16
BARBCONE LOCK PTFE Insulated Terminals 	<ul style="list-style-type: none"> insulated terminal designed for mounting on chassis/frameworks. hermetically sealed versions available as standard. hand assembly tools available for ease of insertion. 	23
BARBCONE LOCK Plugs and Sockets 	<ul style="list-style-type: none"> PCB Edge Mounted Variants available for card-rack systems. Colour options for PTFE Bush. in-line and stackable styles to reduce real estate. ease of assembly to increase production. 	33

Features

- Unique retention mechanism enhances reliability through low stress connections.
- Minimum contact resistance (less than 2 mΩ) through 8 points of contact.
- Chamfer design allows excellent solder fillets to be formed.
- Available loose or taped and reeled.
- Award winning kinematic design allows rapid connection/disconnection.
- Proven application through Snaplox range of test points.
- Hand or automatic assembly.

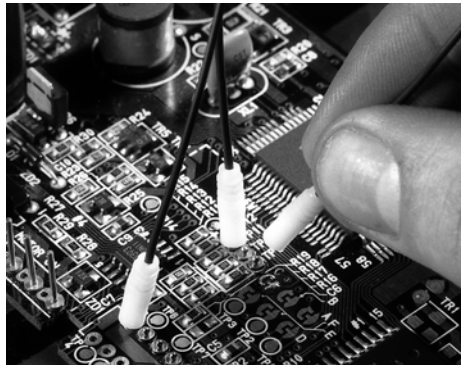

Surface Mount Applications

Surface-Mount Oxley (SMOX) Test-Point is available Taped and Reeled, with a compatible mating socket and is suitable for a range of applications.

Due to the unique nature of the SMOX Connection System, it represents the only Surface Mount Test Point available on the market with a specially designed socket for easy low contact resistance and gentle detachment; the applications and potential uses are limitless.

Requiring a minimum pad size of only two millimetres (0.080”), and being a singlepole device, the SMOX can be placed accurately by any Pick and Place machine in even the most congested designs. The socket is normally used with the recommended PTFE Insulated Sleeve, (diameter 3.2 mm/ 0.128”), but for those very close pitch designers, this can be replaced with alternative insulation techniques.

Detecting and localising board faults is an obvious application, where the ability to quickly and individually identify faulty components, cracked solder joints or short circuits can save time of testing via an edge mounted connector, or under a microscope.

On thick multilayered boards, where complex track designs can lead to very expensive PCB's, the benefits of quickly and effectively identifying and repairing any faulty populated PCB can be easily recognised.

The ability to monitor waveform characteristics and determine the performance of a circuit with variable components is vital, and not just in a test laboratory. Where exact frequency output is required, a certain waveform is needed or the ability to manually set the characteristics of each production board manufactured; the inclusion of SMOX Test Points fulfils that requirement.

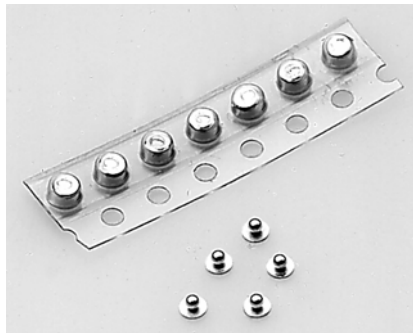

Key Characteristics

Gold plated SMOX Test Point for low contact resistance and durability.

SMOX Connector Systems to reduce the risk of accidental damage to the PCB. Can be used on any Pick and Place machine using vacuum nozzles.

Square or round solder pads can be used, with a minimum pad size of 2 mm diameter.

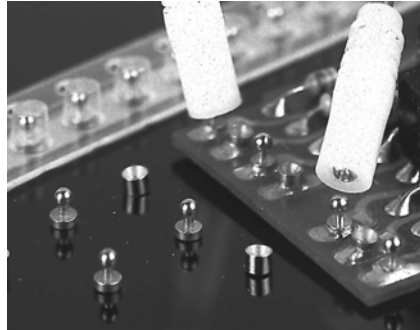

Sockets are gently detached when moved beyond an angle of 30° from vertical.

Packaging

The SMOX/060/B1LP.R3K Test Point is available on Tape and Reel, to enable placement on to PCB's by a variety of pick and Place machines. The plastic reels are an industry standard 7" diameter and the R3K extension denotes 3,000 components in a specially designed carrier tape.

The SMOX/060/B1-R2K test point is available on Tape and Reel, to enable placement on to PCB's by a variety of pick and Place machines. The plastic reels are an industry standard 7" diameter and the .R2K extension denotes 2,000 components in a specially designed carrier tape.

The solid flat bottomed pocket ensures the component is in the correct vertical position when the heat sealing backing tape is peeled off. 100% visual inspection by camera during population of the tape ensures no components are heat sealed in place in the wrong position, or that empty pockets can be sealed.

For customers requiring the SMOX Socket to be supplied assembled, a standard product is available on 15" of cable, with differing lengths possible where demand exists.

SMOX Surface Mount Test Points

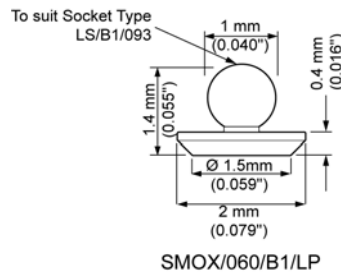
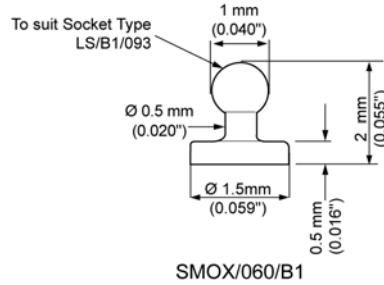

Wires shown for illustration purposes only.

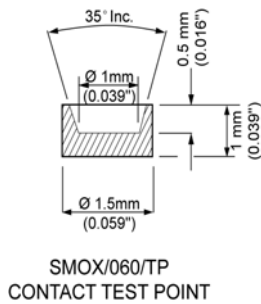
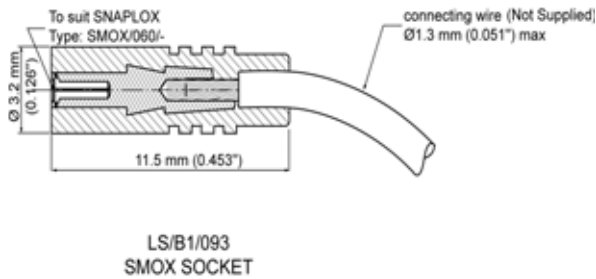

Materials

Test Point	Copper Alloy
Socket Body	Copper Alloy
Insulation	High dispersion grade PTFE standard colours - white, black and red. Other colours available on request.
Finishes	
Standard	Gold
Options	Palladium, Silver, Nickel or Tin Lead
Socket	Silver

Characteristics

Maximum Contact Resistance (with socket)	2 milliOhms
Maximum Angular Movement before Disconnection	±30°
Socket Insulation Resistance	10,000 MOhms minimum
Typical Retention Force (angles less than 60° or ±30°) off perpendicular	0.2 kgs
Typical Retention Torque (angles greater than 30°) or perpendicular	200 gcm
Current for 10°C Rise Above Ambient	3 A
Climatic Category	-55 to +125 °C, 56 days damp heat (IEC 68:55/125/56)
Solderability	Exceeds Requirements of BS 2011 (IEC 68) Test T

Assembly Tools

Tool Numbers Required for SMOX Sockets (LS/B1/093) Assembly	AT1/KP18 and AT1/KP19
--	-----------------------

Taping and Reeling

Tape	4 mm pitch 8 mm wide
Reel Sizes: SMOX/060/B1/LP.R3K 7 inch	3,000 components
Reel Sizes: SMOX/060/B1.R2K 7 inch	2,000 components

Features

- Unique kinked retention mechanism retains pin in PCB plated through hole (PTH) prior to soldering.
- Low insertion force avoids damage to plating of PTH during assembly.
- Slotted design enhances solderability and reliability.
- Family optimised for a wide range of PTH diameters
0.508 mm (0.020") -
1.524 mm (0.060").
- Capable of hand and semi-automatic machine insertion.
- Available in a wide range of styles and finishes for alternative applications.
- Vibratory bowl fed semi-automatic insertion machines available, details on request.

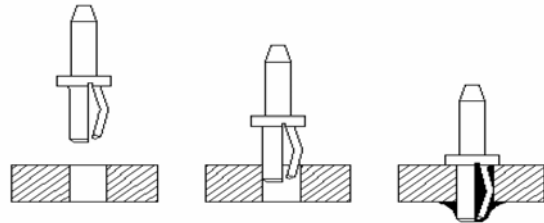

Application

- Self retaining compliant pin for plated through holes in multilayer printed circuit boards.

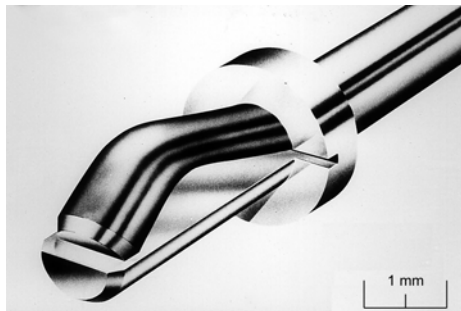

Kinky Pins

Kinky Pins were designed specifically to meet the demands of plated through hole (PTH) technology introduced in printed circuit boards. They tend to be used with flexi-circuit termination and as solder terminals, connectors and in multiway pin arrays.

They use a unique kinked retention mechanism which gives a fit in the PTH that is unsurpassed. The kinked leg provides a tight non-aggressive spring loaded fit whilst the straight leg ensures the pin is kept perpendicular to the PCB prior to soldering.

This Kinky Pin mechanism gives an additional benefit which is a key part of its operation. The slotted design induces wicking of the solder up into the kink and up to the flange which means that the solder joint is solid and free of air pockets. This reduces the possibility of dry joints developing and the life of the solder joint is therefore increased. In our opinion and that of our customers, there is no better PTH solder-in terminal!

The Kinky Pin range is comprehensive and our in-house high precision machining capabilities mean that we have the ability to manufacture bespoke versions on request. Standard finishes are tin lead and gold; other finishes are available on request.

Prefix: 020/-
Mounting Hole Diameter:
 0.52 mm (0.020") - 0.68 mm (0.027")
Min. Pitch Using Assembly Tool:
 2.5 mm (0.098")
Shoulder Diameter A:
 1.0 mm (0.039")

Prefix: 028/-
Mounting Hole Diameter:
 0.68 mm (0.027") - 0.84 mm (0.033")
Min. Pitch Using Assembly Tool:
 2.5 mm (0.098")
Shoulder Diameter A:
 1.6 mm (0.063")

Prefix: 030/-
Mounting Hole Diameter:
 0.81 mm (0.032") - 0.96 mm (0.038")
Min. Pitch Using Assembly Tool:
 2.5 mm (0.098")
Shoulder Diameter A:
 1.6 mm (0.063")

Prefix: 040/-
Mounting Hole Diameter:
 0.96 mm (0.038") - 1.12 mm (0.044")
Min. Pitch Using Assembly Tool:
 2.5 mm (0.098")
Shoulder Diameter A:
 1.6 mm (0.063")

Prefix: 050/-
Mounting Hole Diameter:
 1.21 mm (0.048") - 1.37 mm (0.054")
Min. Pitch Using Assembly Tool:
 3.0 mm (0.118")
Shoulder Diameter A:
 2.4 mm (0.094")

Prefix: 060/-
Mounting Hole Diameter:
 1.50 mm (0.059") - 1.65 mm (0.065")
Min. Pitch Using Assembly Tool:
 3.0 mm (0.118")
Shoulder Diameter A:
 2.4 mm (0.094")

Kinky Pin Test Points

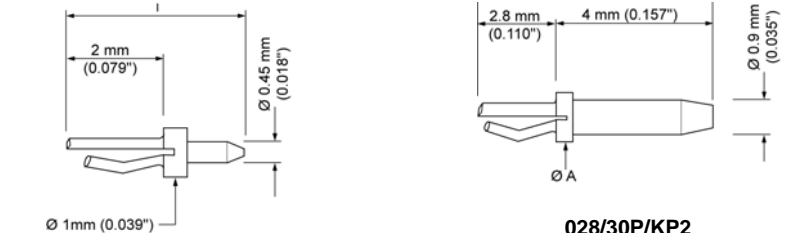

020/C/KP2 [l = 3.7 mm (0.146")]
020/PT/KP2 [l = 6.1 mm (0.240")]
020/PT/KP2/L [l = 7.3 mm (0.287")]

028/30P/KP2
030/30P/KP2
040/30P/KP2
050/30P/KP2
060/30P/KP2

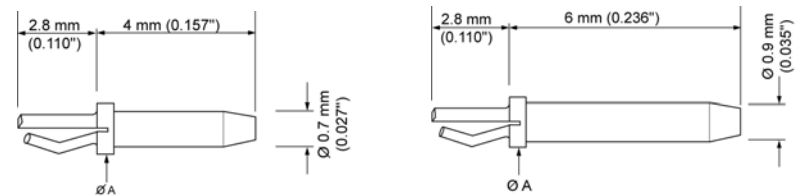

028/30P/LA/KP2
030/30P/LA/KP2
040/30P/LA/KP2
050/30P/LA/KP2
060/30P/LA/KP2

028/30P/KP2/L
030/30P/KP2/L
040/30P/KP2/L
050/30P/KP2/L
060/30P/KP2/L

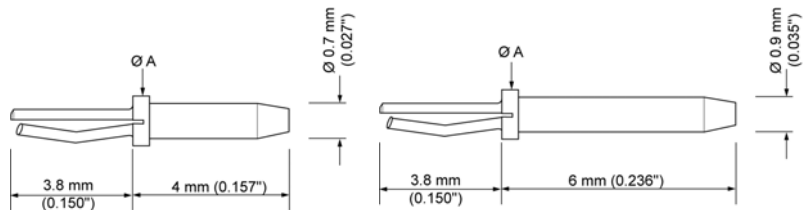

028/10P/30P/LA/KP2
030/10P/30P/LA/KP2
040/10P/30P/LA/KP2
050/10P/30P/LA/KP2
060/10P/30P/LA/KP2

028/10P/30P/KP2/L
030/10P/30P/KP2/L
040/10P/30P/KP2/L
050/10P/30P/KP2/L
060/10P/30P/KP2/L

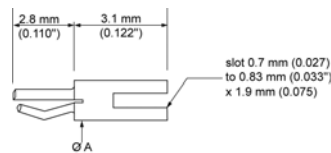

028/T/KP2
030/T/KP2
040/T/KP2
050/T/KP2
060/T/KP2

Prefix: 028/-
Mounting Hole Diameter:
 0.68 mm (0.027") - 0.84 mm (0.033")
Min. Pitch Using Assembly Tool:
 2.5 mm (0.098")
Shoulder Diameter A:
 1.6 mm (0.063")

Prefix: 030/-
Mounting Hole Diameter:
 0.81 mm (0.032") - 0.96 mm (0.038")
Min. Pitch Using Assembly Tool:
 2.5 mm (0.098")
Shoulder Diameter A:
 1.6 mm (0.063")

Prefix: 040/-
Mounting Hole Diameter:
 0.96 mm (0.038") - 1.12 mm (0.044")
Min. Pitch Using Assembly Tool:
 2.5 mm (0.098")
Shoulder Diameter A:
 1.6 mm (0.063")

Prefix: 050/-
Mounting Hole Diameter:
 1.21 mm (0.048") - 1.37 mm (0.054")
Min. Pitch Using Assembly Tool:
 3.0 mm (0.118")
Shoulder Diameter A:
 2.4 mm (0.094)

Prefix: 060/-
Mounting Hole Diameter:
 1.50 mm (0.059") - 1.65 mm (0.065")
Min. Pitch Using Assembly Tool:
 3.0 mm (0.118")
Shoulder Diameter A:
 2.4 mm (0.094)

**1 mm Snaplox Kinky-Pins
(To Suit Socket Type Number LS/B1/093)**

Wires Shown for illustration purposes only.

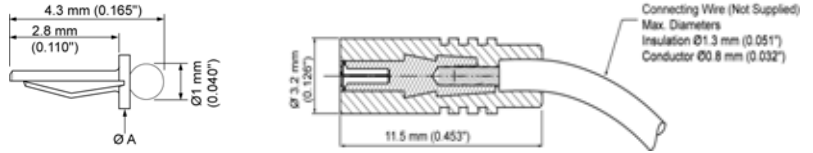

030/B1/KP2
040/B1/KP2
050/B1/KP2

LS/B1/093
 (To suit 1 mm Snaplox)

**2 mm Snaplox Kinky-Pins
(To Suit Socket Type Number LS/B2/156)**

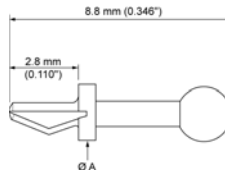

028/SO/BK2F
030/SO/BK2F
040/SO/BK2F
050/SO/BK2F
060/SO/BK2F

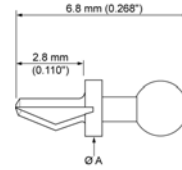

028/SO/BK2P
030/SO/BK2P
040/SO/BK2P
050/SO/BK2P
060/SO/BK2P

Socket

Wires Shown for illustration purposes only.

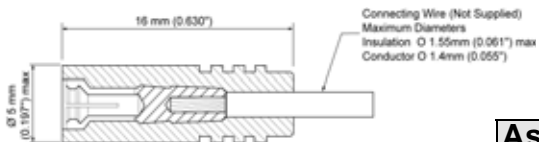

LS/B2/156
 (To suit all 2 mm Snaplox)

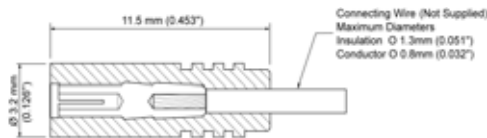

30/LS/093
 (To suit -/30P/KP2 AND -/30P/KP2/L))

Assembly Tools
-/30P/KP2, -/30P/KP2/L AT1/KP1
(028 - 040)/T/KP2, -/-BK2F, -/-BK2P AT1/KP2
-/10P/30P/KP2/L, (050 - 060)/T/KP2 AT1/KP3
-/30P/LA/KP2/L, -/10P/30P/LA/KP2 AT1/KP4

Materials

Pin		Copper alloy
Sockets	Contact Insulation	Brass High dispersion grade PTFE
Finishes:		
Pin	Standard Options	Tin Lead Gold (standard on Snaplox Kinky Pins)
Socket	Standard Options	Silver Gold

Characteristics

Contact Resistance (with socket)	less than 5 millohms
Current for 10°C Rise Above Ambient	7 A
Climatic Category	- 55 to +125 °C
Solderability	Exceeds Requirements of BS 2011 (IEC 68) Test T

Assembly Tools

Component Type Number	Tool Number
-/30P/KP2 -/30P/KP2/L -/LT/30P/KP2/L	AT1/KP1
(028 - 040) /T/KP2 -/LT/T/KP2 -/-/BK2F -/-/BK2P	AT1/KP2
-/10P/30P/KP2/L (050 - 060) /T/KP2	AT1/KP3
-/30P/LA/KP2 -/10P/30P/LA/KP2	AT1/KP4
O20/C/KP2 O20/PT/KPT O20/PT/KP2/L	AT1/KP20

Mounting Details and Shoulder Diameter

Mounting Details : Minimum Board Thickness 1.4 mm (0.055") 0.9 mm (0.036") for 020/- and 2.36 mm (0.093") for -/10P			
Prefix No	Mounting Hole Dia. After Through Plating	Min. Pitch Using Assembly Tool	ØA
020/-	0.52 mm (0.020") - 0.68 mm (0.027")	2.5 mm (0.098")	1.0 mm (0.039")
028/-	0.68 mm (0.027") - 0.84 mm (0.033")	2.5 mm (0.098")	1.6 mm (0.063")
030/-	0.81 mm (0.032") - 0.96 mm (0.038")	2.5 mm (0.098")	1.6 mm (0.063")
040/-	0.96 mm (0.038") - 1.12 mm (0.044")	2.5 mm (0.098")	1.6 mm (0.063")
050/-	1.21 mm (0.048") - 1.37 mm (0.054")	3.0 mm (0.118")	2.4 mm (0.094")
060/-	1.50 mm (0.059") - 1.65 mm (0.065")	3.0 mm (0.118")	2.4 mm (0.094")

Features

- Patented Snale® form provides high retention and rigidity.
- Low insertion force allows easy hand assembly.
- Serrated outline inhibits rotation.
- For use with 1.02 mm (0.040") and 1.27 mm (0.050") diameter holes.
- Available in a wide range of styles and finishes for differing applications.

Application

- Self retaining interference fit pin for single and double sided printed circuit boards and chassis.

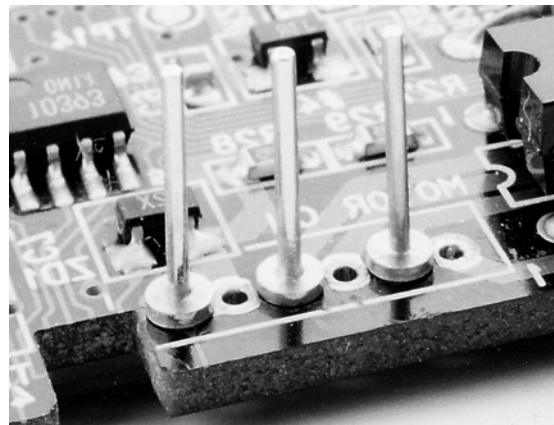

Snale Pins

The use of Snale Pins has been widely established in the commercial and military electronics market worldwide as the definitive terminal pin for use with non-plated through hole PCB's and chassis.

The knurled and barbed retention mechanism gives a low insertion force, high retention and non-rotation fit ensuring rigidity with ease of assembly. The snale Pin range is available in a variety of lengths and diameters to suit applications such as multiway pin headers on aircraft engine control systems, as pins in connectors and lead-through terminals and solder posts on flow meters.

They are available in standard Tin Lead and Gold finishes with others available on request. Bespoke styles are also available due to our in-house high precision machining capabilities.

Prefix: SN/040/-

Mounting Hole Diameter:

1.02 mm ± 0.04 mm
(0.040" ± 0.0016")

Board Thickness:

0.8 mm (0.031") min.

Hole Diameter (Copper clad paper phenolic, 1.6 mm (0.063") thick):

1.05 mm (0.0415"), 1.02 mm (0.040"), 0.98 mm (0.0385")

Retention Force (kg):

5, 6, 8

SN/040/- Series

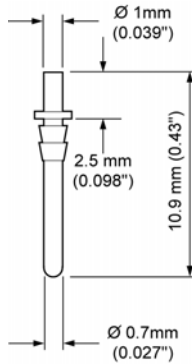

SN/040/LTU

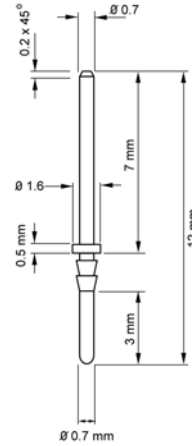

SN/040/LT/BA

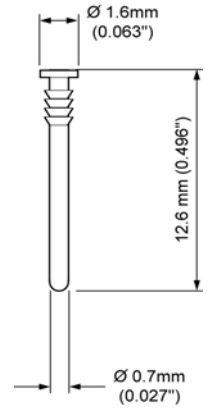

SN/040/RPL

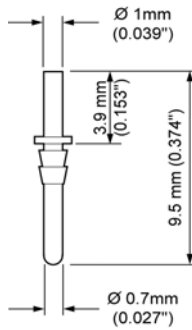

SN/040/LT

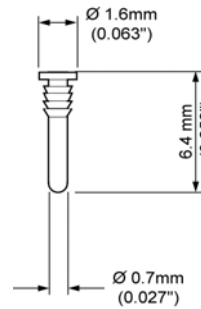

SN/040/RP

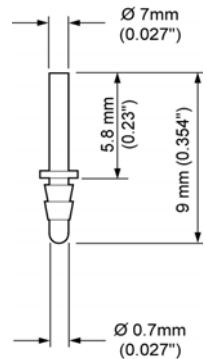

SN/040/LT/D

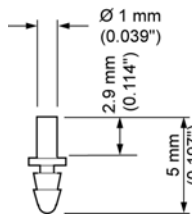

SN/040/SO/PG

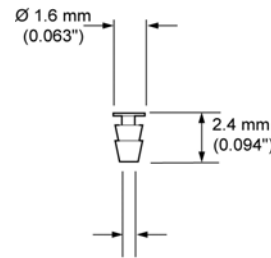

SN/040/RP/H

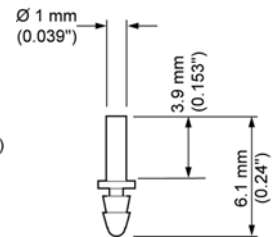

SN/040/SO

Prefix: SN/050/-

Mounting Hole Diameter:

1.31 mm ± 0.06 mm
(0.052" ± 0.002")

Board Thickness:

0.8 mm (0.031") min.

Hole Diameter (Copper clad paper phenolic, 1.6 mm (0.063") thick):

1.32 mm (0.052"), 1.30 mm (0.051"),
1.25 mm (0.049")

Retention Force (kg):

4, 5, 6

SN/050/- Series

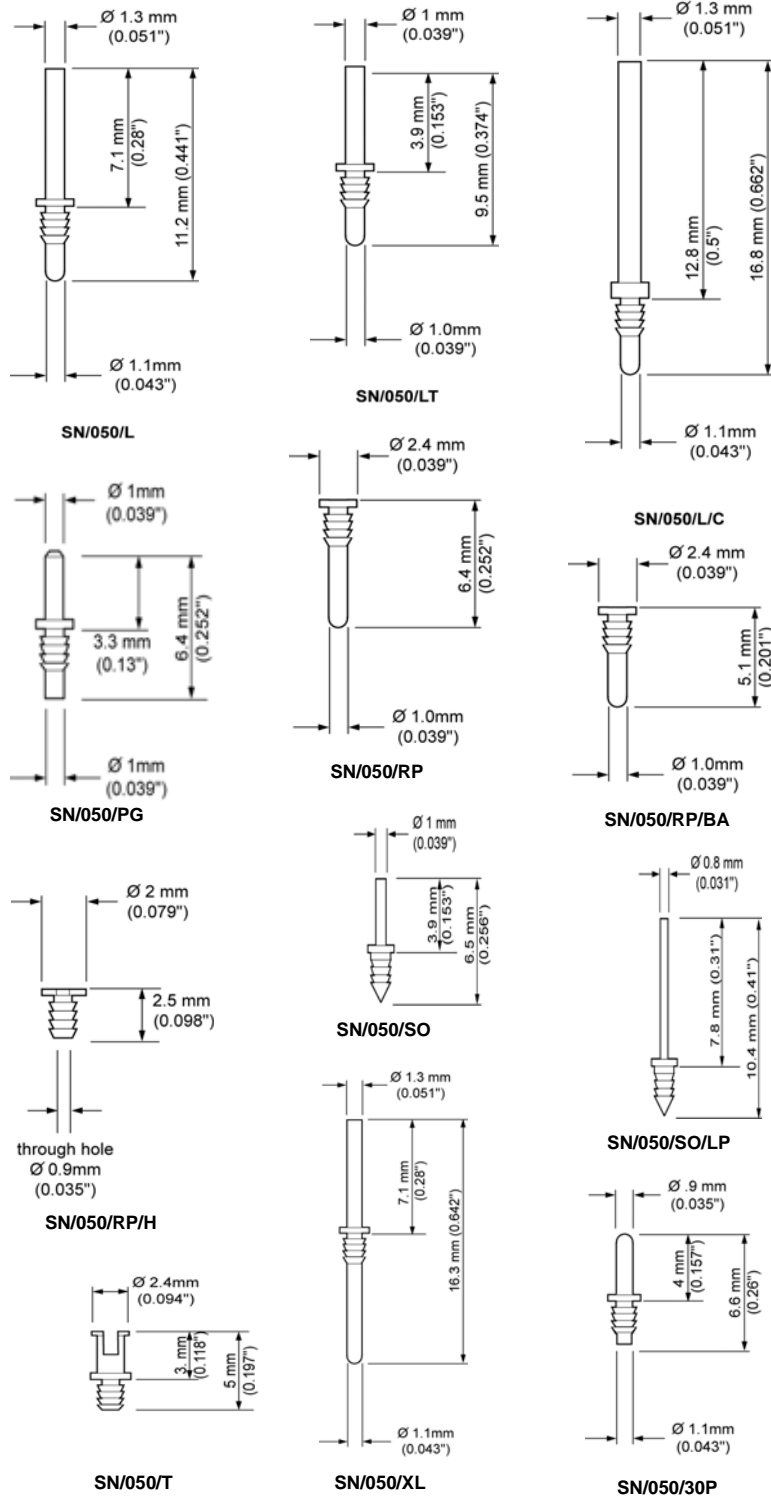

Materials

Pin/Contacts	Brass	
Finishes		
Pin/Contacts	Snale Snaplox Snale	Tin Lead Palladium
Socket	Option	Silver Gold

Characteristics

Contact Resistance	< 2 mOhms (SN/050/30P-30LS/093) < 10 mOhms (Snaplox Snales)
Solderability	Exceeds Requirements of BS 2011 (IEC 68) Test T

Assembly Tools

Component Type Number	Tool Number
SN/040/LT-	AT1/10
SN/040/RP-	AT1/13
SN/040/RP/H	AT2/03/A
SN/040/SO	AT1/10
050/-	AT1/09
SN/050/30P	AT1/18
SN/050/L	AT1/11
SN/050/LT	AT1/10
SN/050/L/C	AT1/02
SN/050/PG	AT1/05
SN/050/RP	AT1/12
SN/050/RP-	AT1/01
SN/050/RP/H	AT2/02/A
SN/050/SO/-	AT1/10
SN/050/T	AT1/06
SN/050/XL	AT1/11
30LS/093	AT1/01 ATS 2/08
LS/B2/156	AT2/01 ATS 3/05

Mounting Details

Prefix No	Mounting Hole Diameter	Typical Retention Force (Kg)	Board Thickness
SN/050/-	1.32 mm (0.052")	4	0.8 mm (0.031") min.
	1.30 mm (0.051")	5	
	1.25 mm (0.049")	6	
SN/040/-	1.05 mm (0.0415")	5	0.8 mm (0.031") min.
	1.02 mm (0,040")	6	
	0.98 mm (0.0385")	8	

Features

- Award winning kinematic design allows rapid connection/disconnection.
- High retention force with socket (at angles less than 30°) and eight point contact ensures low contact resistance.
- Low detachment force with socket (at angles greater than 30°) reduces risk of inadvertent damage to pcb during test.
- Surface mount, self retaining and straight shank designs available.
- Hand or semi-automatic machine assembly. Details on request.

Application

- Plated through hole, multilayer and ceramic and printed circuits and hybrids.

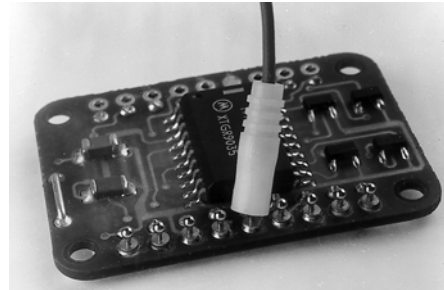
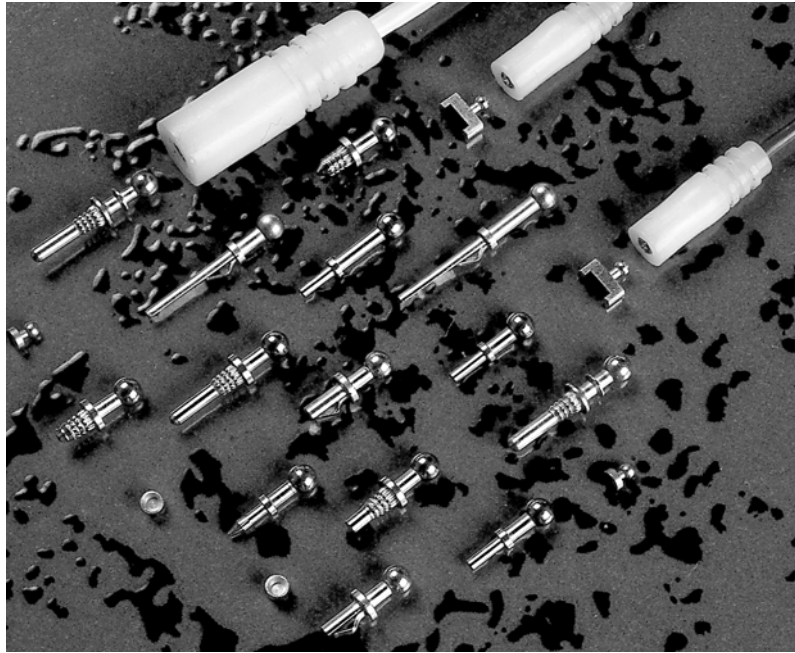

Snaplox®

The Snaplox® name has firmly established itself in the world electronics market. The award winning design has yielded use in a vast range of applications in the commercial and military electronics world. Applications which use them include towed sonar arrays and rolling stock electronics equipment.

The Snaplox® concept enables highly accurate testing to be done whilst reducing the risk of board damage. This is due to the unique ball and socket arrangement which provides 8 points of low resistance contact through a 60° connection angle. Beyond this 60° the socket disconnects with ease preventing stress to the pin and board.

The standard finishes are palladium or Gold plated pin and PTFE insulated Silver plated socket to give a robust, long life, low contact resistance test point system. Other finishes are available on request.

They are available with a range of PCB (surface mount, Kinky Pin and Snale) and chassis mounting (Barb Cone-Lock) retention mechanisms to suit most applications and bespoke styles can be manufactured as needed due to our in-house, high precision machining capabilities.

Part Number: SN/040/-/B1

Mounting Hole Diameter:
0.81 mm (0.032") - 0.96 mm (0.038")
PCB Thickness:
1.4 mm (0.055") min.
Shoulder Diameter A:
1.6 mm (0.063")
Assembly Tool:
Snaplox Kinky-Pins - AT 1/09

1 mm Miniature Snaplox (Kinky Pin)

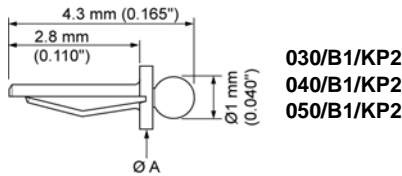

Part Number: 062/B1

Mounting Hole Diameter:
1.57 mm (0.062")
PCB Thickness:
0.56 mm (0.022") - 0.71 (0.028")
Shoulder Diameter A:
N/A
Assembly Tool:
AT 1/01

1 mm Miniature Snaplox (Snale)

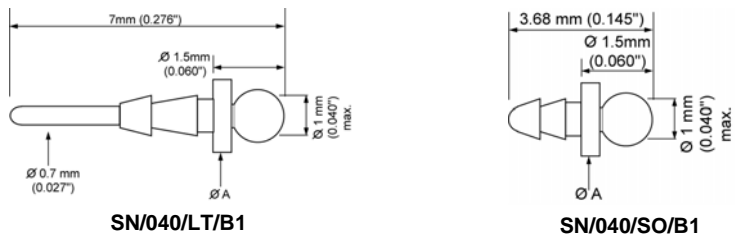

Prefix: 028/-

Mounting Hole Diameter:
0.68 mm (0.027") - 0.84 mm (0.033")
PCB Thickness:
1.4 mm (0.055") min.
Shoulder Diameter A:
1.6 mm (0.063")
Assembly Tool:
AT 1/KP2

1 mm Miniature Snaplox (Barb Cone Lock)

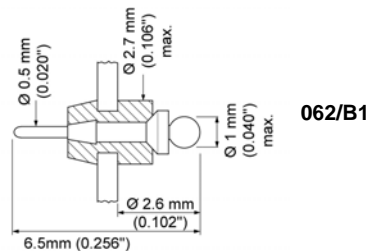

Prefix: 030/-

Mounting Hole Diameter:
0.81 mm (0.032") - 0.96 mm (0.038")
PCB Thickness:
1.4 mm (0.055") min.
Shoulder Diameter A:
1.6 mm (0.063")
Assembly Tool:
AT 1/KP2

Kinky Pin Snaplox

(self retaining compliant fit for plated through hole multilayer pcbs)

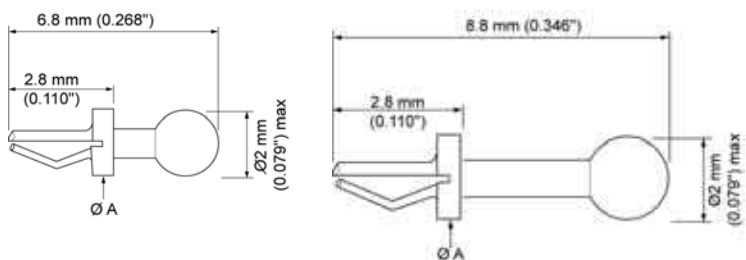

Prefix: 040/-

Mounting Hole Diameter:
0.96 mm (0.038") - 1.12 mm (0.044")
PCB Thickness:
1.4 mm (0.055") min.
Shoulder Diameter A:
1.6 mm (0.063")
Assembly Tool:
AT 1/KP2

028/SO/BK2P
030/SO/BK2P
040/SO/BK2P
050/SO/BK2P
060/SO/BK2P

028/SO/BK2F
030/SO/BK2F
040/SO/BK2F
050/SO/BK2F
060/SO/BK2F

Prefix: 050/-

Mounting Hole Diameter:
1.21 mm (0.048") - 1.37 mm (0.054")
PCB Thickness:
1.4 mm (0.055") min.
Shoulder Diameter A:
2.4 mm (0.094")
Assembly Tool:
AT 1/KP2

Prefix: 060/-

Mounting Hole Diameter:
1.52 mm (0.060") - 1.62 mm (0.064")
PCB Thickness:
1.4 mm (0.055") min.
Shoulder Diameter A:
2.4 mm (0.094")
Assembly Tool:
AT 1/KP2

Prefix: 050/-(Snales)

Mounting Hole Diameter:
1.25 mm (0.049") - 1.40 mm (0.055")
PCB Thickness:
1.4 mm (0.055") min.
Shoulder Diameter A:
2.4 mm (0.094")
Assembly Tool:
AT 1/09

Part Number: 030/SO/B2

Mounting Hole Diameter:
0.81 mm (0.032") - 0.92 mm (0.036")
PCB Thickness:
1.65 mm (0.065") - 1.85 mm (0.073")
Shoulder Diameter A:
1.6 mm (0.063")
Assembly Tool:
AT 1/09

Snales Snaplox
(Self Retaining Fit for Single and Double sided pcbs)

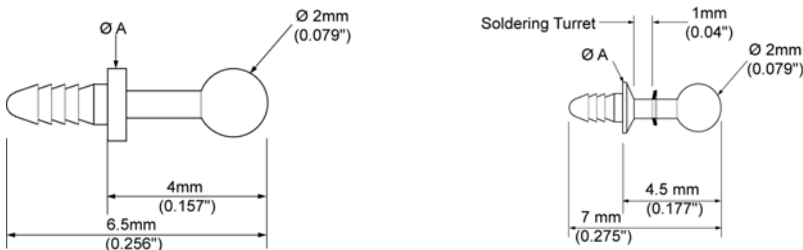

050/SO/B2

050/SO/BST

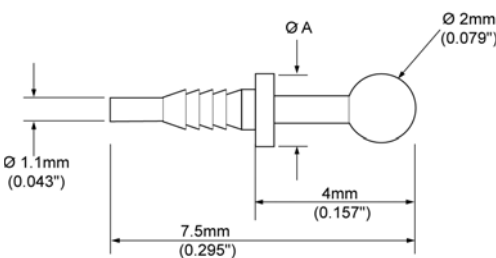

050/SOX/B2

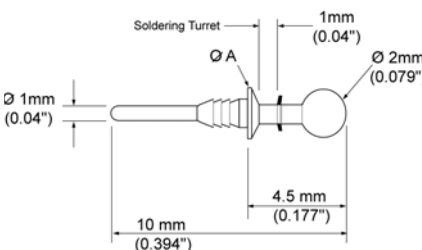

050/LT/BST

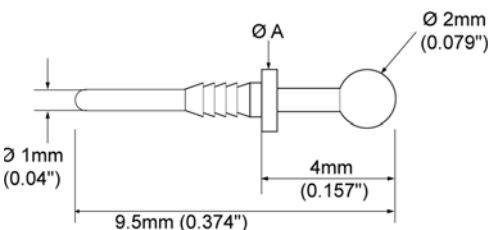

050/LT/B2

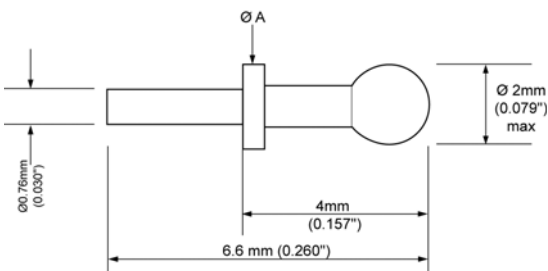

030/SO/B2

Part Number: 030/SO/BF

Mounting Hole Diameter:
0.81 mm (0.032") - 0.92 mm (0.036")
PCB Thickness:
1.65 MM (0.065") - 1.85 MM (0.073")
Shoulder Diameter A:
1.6 mm (0.063")
Assembly Tool:
AT 1/09

Part Number: 030/SO/BCS/-

Mounting Hole Diameter:
0.81 mm (0.032") - 0.92 mm (0.036")
PCB Thickness:
1.65 MM (0.065") - 1.85 MM (0.073")
Shoulder Diameter A:
1.6 mm (0.063")
Assembly Tool:
AT 1/09 or AT 1/KP2

Part Number: 050/B2/RS

Mounting Hole Diameter:
1.25 mm (0.049") - 1.37 mm (0.054")
PCB Thickness:
N/A
Shoulder Diameter A:
2.4 mm (0.094")
Assembly Tool:
AT 1/09

Part Number: 156/LP/B2

Mounting Hole Diameter:
3.95 mm (0.155") - 4.05 mm (0.159")
Chassis Thickness:
1.2mm (0.047") - 1.6 mm (0.063")
Assembly Tool:
AT 1/09

Snale Snaplox Continued

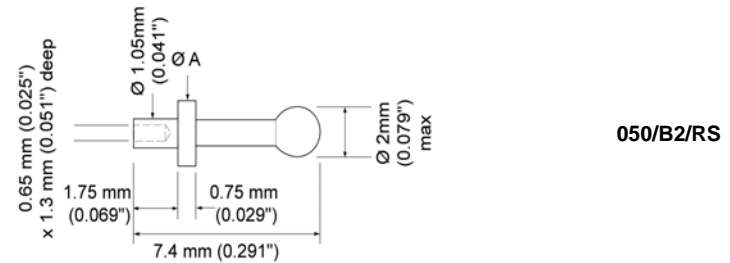
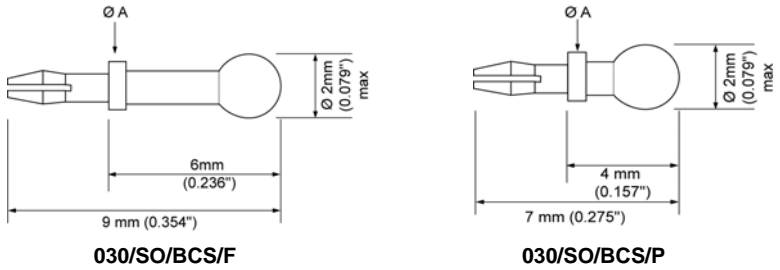
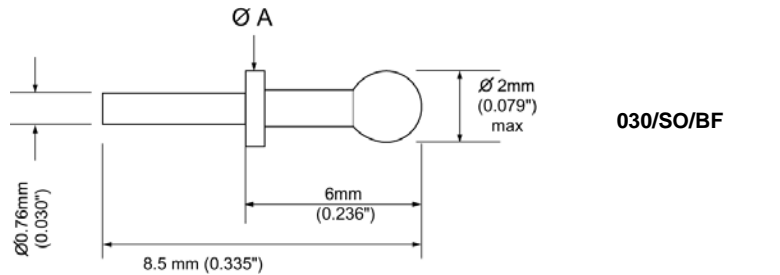

Insulated Terminals Snaplox

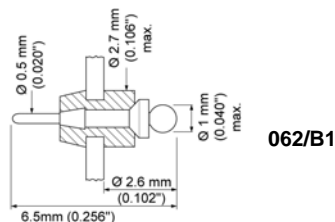
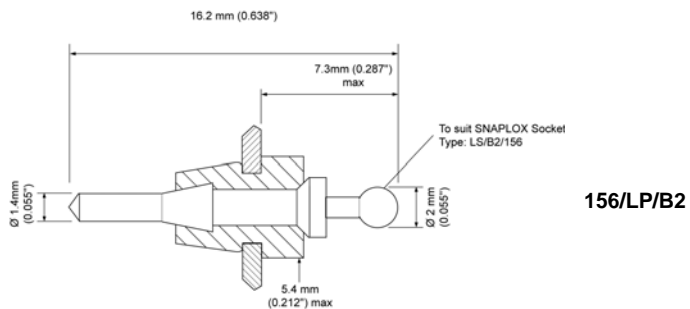

Part Number: LS/B2/156

Assembly Tool:
AT 2/05 & ATS 3/05

Socket (Connects with all 2 mm Snaplox)

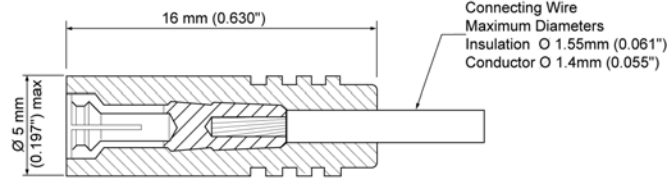

LS/B2/156

Part Number: LP/B2/156

Assembly Tool:
AT 1/09

Line Plug (Connects with LS/B2/156)

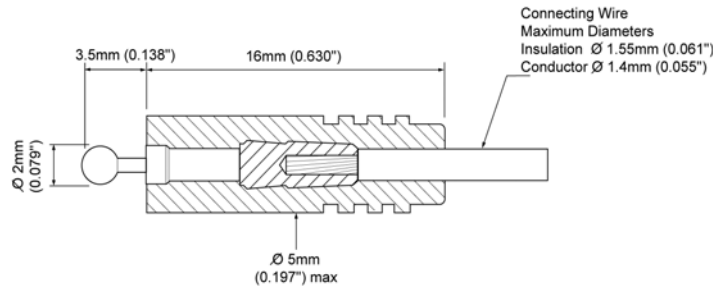

LP/B2/156
(To suit LS/B2/156))

Wires shown for illustration purposes only.

Materials

Pin	Brass
Exceptions Kinky Pin Snaplox SMOX Test Points	Copper alloy Copper alloy
Socket	Copper Alloy
Insulation	High dispersion grade PTFE standard colours - white, black and red. Other colours available on request.
Finishes	
Pin	Palladium
Exceptions Kinky Pin Snaplox	Gold
Socket	Silver

Characteristics

Maximum Contact Resistance (with socket)	2 milliOhms
Maximum Angular Movement before Disconnection	±30°
Socket Insulation Resistance	10,000 MOhms minimum
Typical Retention Force (angles less than 30°)	2 kg (0.2kgs for SMOX/-)
Typical Retention Torque (angles greater than 30°)	200 gcm
Current for 10°C Rise Above Ambient	7 A (3 A for SMOX/-)
Climatic Category	-55 to +125 °C, 56 days damp heat (IEC 68:55/125/56)
Solderability	Exceeds Requirements of BS 2011 (IEC 68) Test T

**Mounting Details and Shoulder
Diameter**

Pin Type No	Mounting Hole Details	PCB Thickness	ØA
028/-	0.68 mm (0.027") - 0.84 mm (0.033")	1.4 mm (0.055") min.	1.6 mm (0.063")
030/-	0.81 mm (0.032") - 0.96 mm (0.038")	1.4 mm (0.055") min.	1.6 mm (0.063")
030/SO/B2	0.81 mm (0.032") - 0.92 mm (0.036")	1.65 mm (0.065") - 1.85 mm (0.073")	1.6 mm (0.063")
030/SO/BF	0.81 mm (0.032") - 0.92 mm (0.036")	1.65 mm (0.065") - 1.85 mm (0.073")	1.6 mm (0.063")
030/SO/BCS/	0.81 mm (0.032") - 0.92 mm (0.036")	1.65 mm (0.065") - 1.85 mm (0.073")	1.6 mm (0.063")
040/-	0.96 mm (0.038") - 1.12 mm (0.044")	1.4 mm (0.055") min.	1.6 mm (0.063")
050/-	1.21 mm (0.048") - 1.37 mm (0.054")	1.4 mm (0.055") min.	2.4 mm (0.094")
050/- (Snales)	1.25 mm (0.049") - 1.40 mm (0.055")	1.4 mm (0.055") min.	2.4 mm (0.094")
050/B2/RS	1.25 mm (0.049") - 1.37 mm (0.054")	N/A	2.4 mm (0.094")
060/-	1.52 mm (0.060") - 1.62 mm (0.064")	1.4 mm (0.055") min.	2.4 mm (0.094")
B2/PCA/-	0.9 mm (0.035") - 1.1 mm (0.043")	1.4 mm (0.055") min.	N/A
156/LP/B2	3.95 mm (0.155") - 4.05 mm (0.159")	1.2 mm (0.047") - 1.6 mm (0.063")	N/A
SMOX/-	2.0 mm min. pad	N/A	N/A
062/B1	1.57 mm (0.062")	0.56 mm (0.022") - 0.71 (0.028")	N/A

Assembly Tools

Component Type Number	Tool Number
Snaplox Kinky Pins	AT 1/KP2
Snaplox Snale Pins	AT 1/09
030/SO/B2	AT 1/09
030/SO/BF	AT 1/09
030/SO/BCS/-	AT 1/09 OR at 1/KP2
050/B2/RS	AT 1/09
LS/B1/093	AT1/KP18 & AT1/KP19
LS/B2/156	AT 2/01 & ATS 3/05
LP/B2/156	AT 1/09 & ATS 3/05
156/LP/B2	AT 1/09

Features

- Simple economical assembly.
- Self-retaining mechanism.
- Rapid assembly.
- High insulation resistance.
- Low capacitance.
- Pressure Sealing.

Application

- Chassis mounting insulated stand off and lead through terminals.
- Pressure bulkhead feedthrough sealing applications.

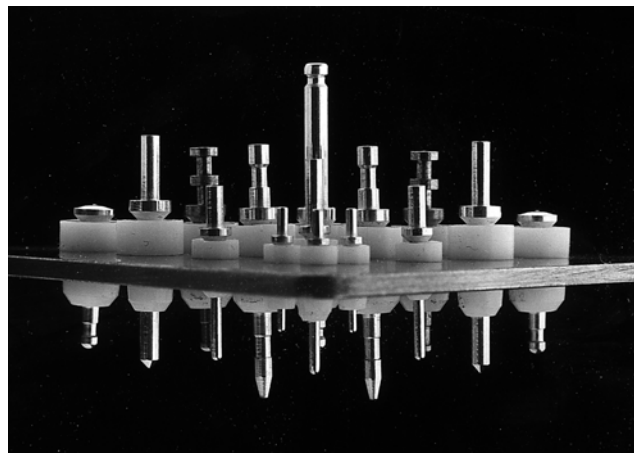
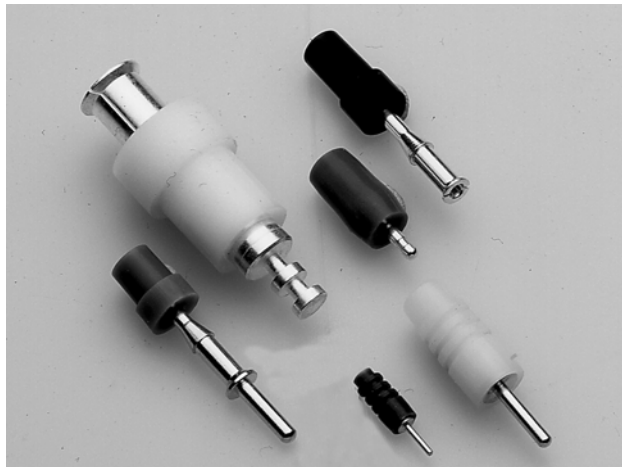

Barb Cone Lock® Insulated Terminals

Oxley Developments designed the Barb Cone Lock® technology. They are constructed from PTFE and have an elastic property which allows the barbed metal spill to lock itself in place by gently expanding the PTFE underneath the chassis during insertion. This ensures a long life, stable fixing in the chassis which is a fundamental part of the product's success.

The product has seen use in a whole host of applications from the military, nuclear and space industries to the medical and telecommunications industries. There is a vast range of types and styles to suit a variety of hole sizes and chassis thicknesses. There are also the "CEEL" high sealing versions for use in applications involving vacuums and differential pressures.

The spills are precision turned, high specification brass material with a silver plating finish as standard. Other finishes are available on request.

We also have the capability to manufacture Barb Cone Locks® in a variety of exotic metals for thermocouple applications.

Prefix: 062/-

Mounting Hole Diameter:

1.57 mm (0.062") nominal

Chassis Thickness:

0.56 mm (0.022") - 0.71 mm (0.028")

Max. Outside Dia. of Bush:

2.7 mm (0.106")

Current Rating (A):

0.5

Rated Voltage at Sea Level (kV d.c.):

0.5

Proof Voltage at Sea Level (kV d.c.):

2.5

Capacitance (pF) (max):

0.5

Assembly Tool:

AT 1/01

062 Range

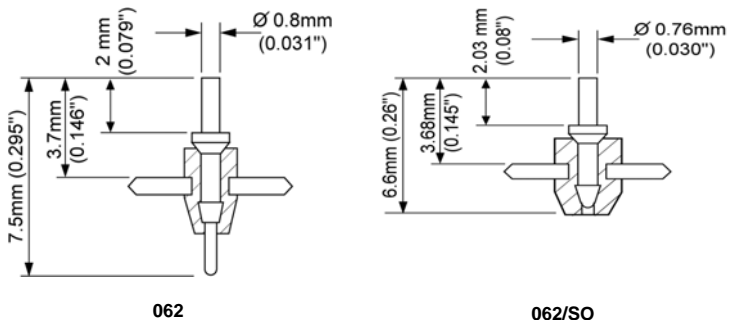

Prefix: 078/-

Mounting Hole Diameter:

1.98 mm (0.078") nominal

Chassis Thickness:

1.2 mm (0.047") - 1.6 mm (0.062")

Max. Outside Dia. of Bush:

2.8 mm (0.110")

Current Rating (A):

1

Rated Voltage at Sea Level (kV d.c.):

0.5

Proof Voltage at Sea Level (kV d.c.):

2.5

Capacitance (pF) (max):

0.5

Assembly Tool:

AT 1/01

078 Range

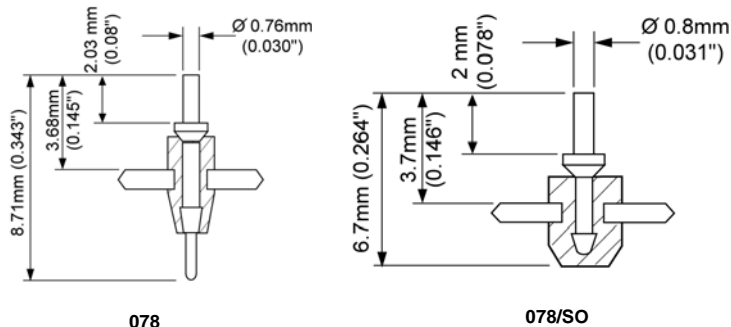

Prefix: 093/-

Mounting Hole Diameter:

2.36 mm (0.093")

Chassis Thickness:

2.03 mm (0.08") - 2.3 mm (0.09")

Max. Outside Dia. of Bush:

3.6 mm (0.142")

Assembly Tool:

AT 1/11

093 Range

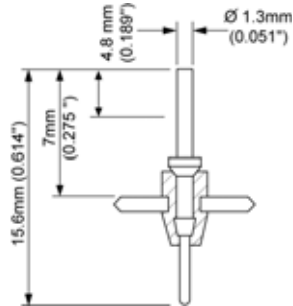

093/16P

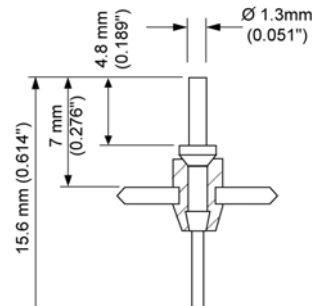

093/093

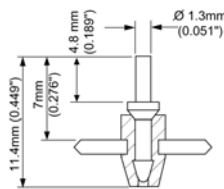

093/SO/16P

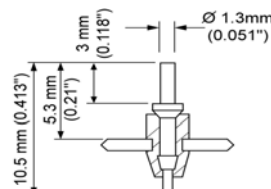

093/20P

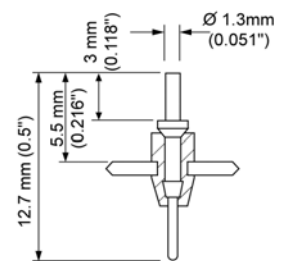

093/18P

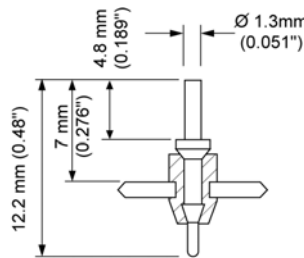

093/20/LP

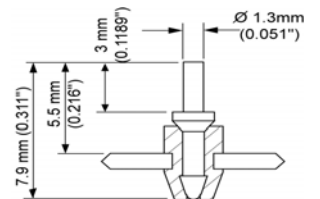

093/SO/18P

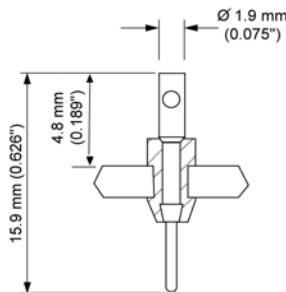

093/6/H

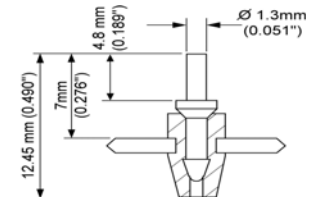

093/093/SO

Prefix: 125/-
Mounting Hole Diameter:
 3.18 mm (0.125")
Chassis Thickness:
 1.2 mm (0.047") - 1.6 mm (0.063")
Max. Outside Dia. of Bush after Assembly:
 5.7 mm (0.224")
Assembly Tool:
 AT 1/05

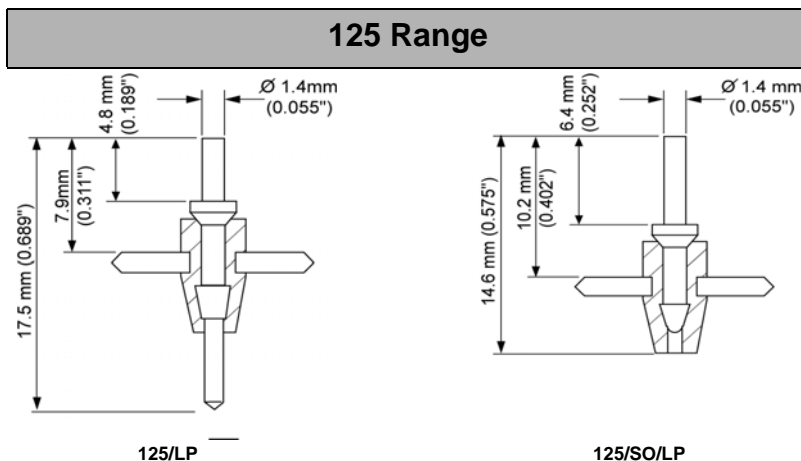

Prefix: 136/-
Mounting Hole Diameter:
 3.45 mm (0.136")
Chassis Thickness:
 1.2 mm (0.047") - 1.6 mm (0.063")
Max. Outside Dia. of Bush after Assembly:
 4.7 mm (0.185")
Assembly Tool:
 136/SO AT 1/11
 136/LP AT 1/17

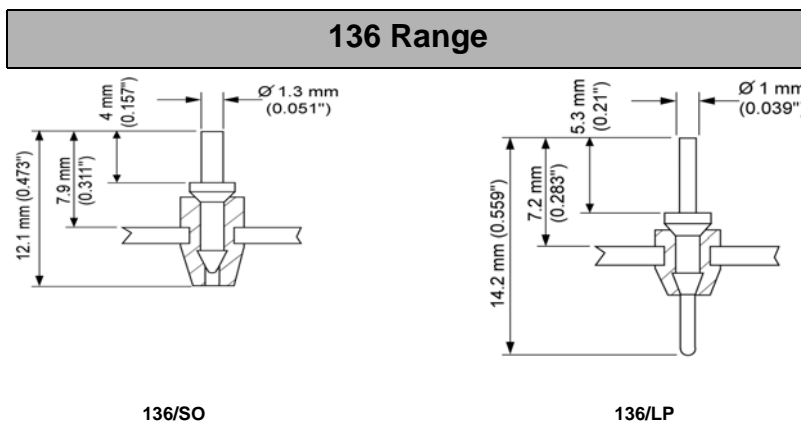

Prefix: 156/-
Mounting Hole Diameter:
 3.96 mm (0.156")
Chassis Thickness:
 1.2 mm (0.047") - 1.6 mm (0.063")
Max. Outside Dia. of Bush after Assembly:
 5.4 mm (0.213")
Assembly Tool:
 156, 156/20, 156/20/S: AT 1/02
 156/DT: AT 1/06

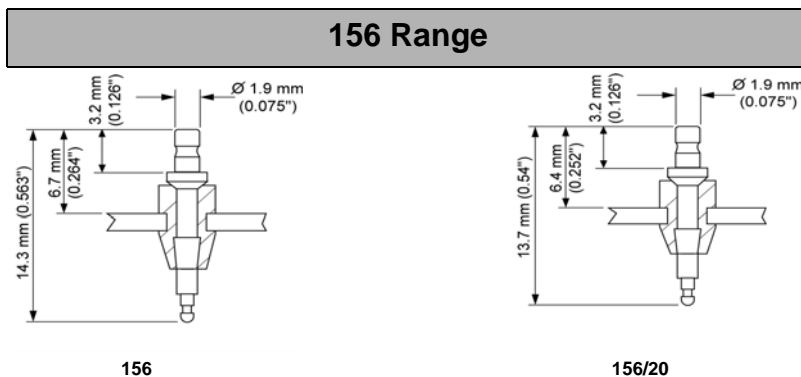

Exceptions:
Chassis Thickness:
-/20:
 0.71 mm (0.028") - 0.91 mm (0.036")
-/DT:
 1 mm (0.039") - 1.4 mm (0.055")

Prefix: 156/-

Mounting Hole Diameter:

3.96 mm (0.156")

Chassis Thickness:

1.2 mm (0.047") - 1.6 mm (0.062")

Max. Outside Dia. of Bush:

5.4 mm (0.213")

Assembly Tool:

AT 1/05

Exceptions:

Chassis Thickness:

-/10P:

2.3 mm (0.09") - 3.2 mm (0.126")

-/20P:

0.71 mm (0.028") - 0.91 mm (0.036")

Assembly Tool:

156E: AT 1/02

156L: AT 1/14

CEEL:156: 10/281/m

CEEL:156: 10/500/m

156 Range (continued)

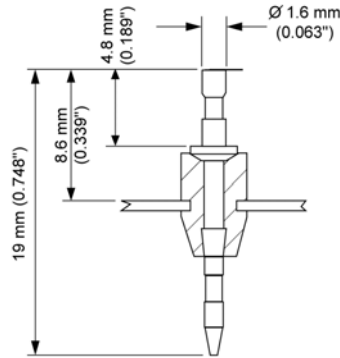

156/E

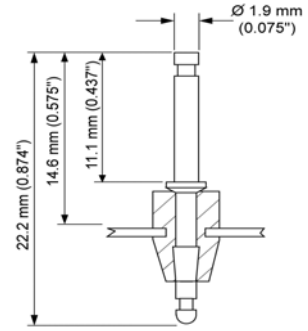

156/L

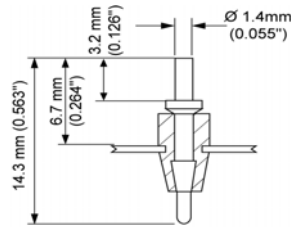

156/P

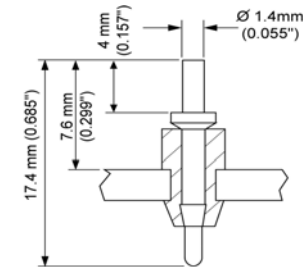

156/10P

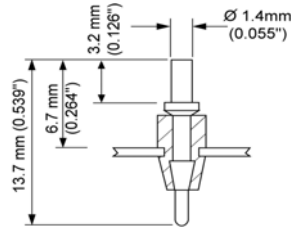

156/20P

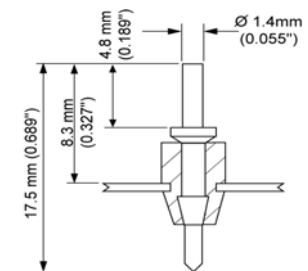

156/LP

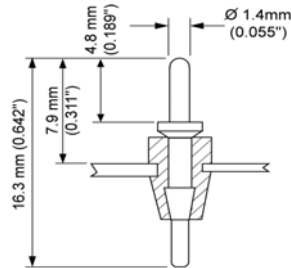

156/LPR

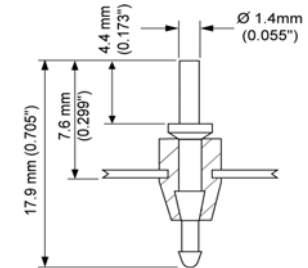

156/AT

156 Range (continued)

Prefix: 156/-

Mounting Hole Diameter:

3.96 mm (0.156")

Chassis Thickness:

1.2 mm (0.047") - 1.6 mm (0.062")

Max. Outside Dia. of Bush:

5.4 mm (0.213")

Assembly Tool:

AT 1/04

Exceptions:

Chassis Thickness:

-/10P:

2.3 mm (0.09") - 3.2 mm (0.126")

-/20P:

0.71 mm (0.028") - 0.91 mm (0.036")

Assembly Tool:

156/SO/XL: AT 1/02

156/LP/B2: AT 1/09

LS/B2/156: AT 2/01

ATS 3/05

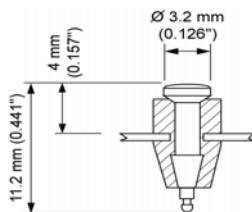

156/M

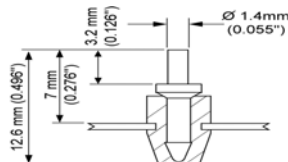

156/SO/P

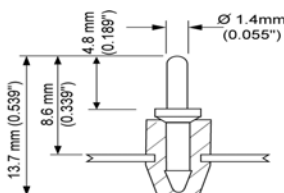

156/SO/LPR

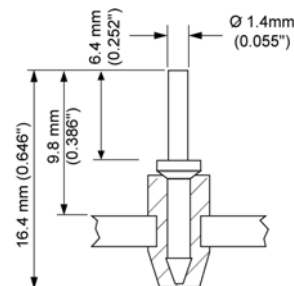

156/SO/10P

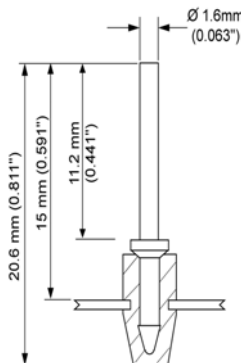

156/SO/XL

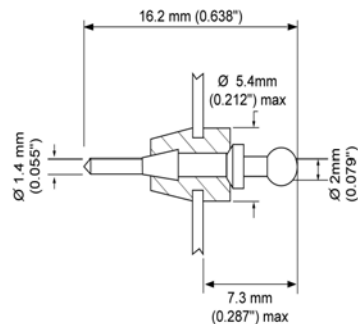

156/LP/B2

Wires shown for illustration purposes only.

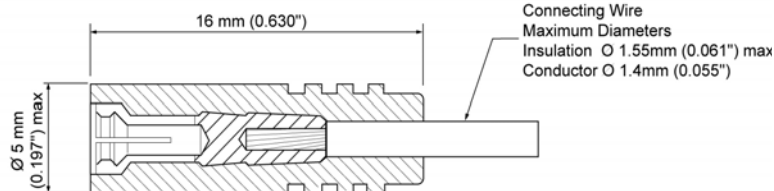

LS/B2/156
To suit 156/LP/B2)

187 Range

Prefix: 187/-
Mounting Hole Diameter:
 4.75 mm (0.187")
Chassis Thickness:
 1.6 mm (0.062") - 2.3 mm (0.09")
Max. Outside Dia. of Bush after Assembly:
 7.4 mm (0.291")
Assembly Tool:
 AT 1/06

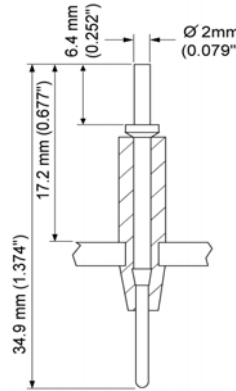

187

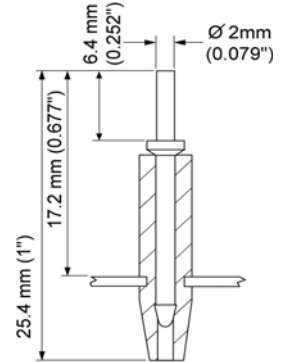

187/SO

250 Range

Prefix: 250/-
Mounting Hole Diameter:
 6.35 mm (0.250")
Chassis Thickness:
 2.3 mm (0.09") - 3.2 mm (0.126")
Max. Outside Dia. of Bush after Assembly:
 8.9 mm (0.350")
Assembly Tool:
 AT 1/07

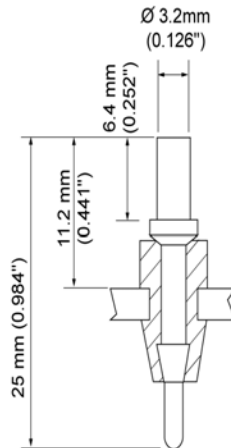

250

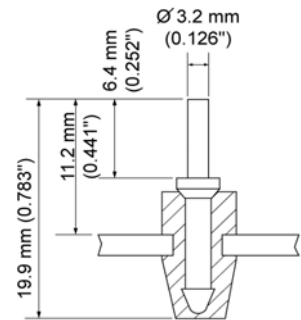

250/SO

Suffix: CEEL

Mounting Hole Diameter: 156/
3.96 mm (0.156")

Mounting Hole Diameter: 250/
6.35 mm (0.250")

Chassis Thickness:
2.4 mm (0.094") - 3.2 mm (0.126")

Assembly Tool:
156/-/CEEL AT1/05
250/-/CEEL AT1/07

Leakage Rate (-/CEEL)

Less than 10^{-3} $\mu\text{l}/\text{sec}$ of Helium.
1 atmosphere differential pressure
(15 lb/in^2) at 20 °C , equivalent to a depth
of 10 m in sea water.

CEEL (Improved Environmental Sealing)

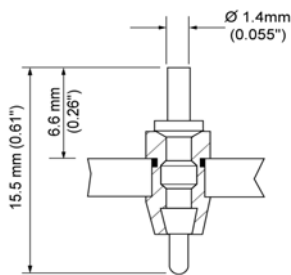

156/10P/CEEL

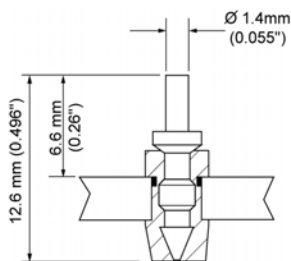

156/SO/10P/CEEL

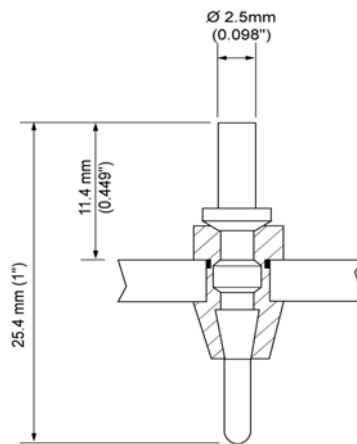

250/10P/CEEL

Materials

Spill	Brass
Bush	High dispersion grade PTFE
Finishes:	
Spill	Standard silver, other finishes available on request
Bush	Colours available: white, black and red

Characteristics

Insulation Resistance	> 2 x 10 ⁶ MOhms
Climatic Category	-55 to +125 °C, 56 days damp heat (IEC 68:55/125/56)

Prefix No.	Current Rating (A)	Rated Voltage at Sea Level (kV d.c.)	Proof Voltage at Sea Level (kV d.c.)	Capacitance (pF) max.
062	0.5	0.5	2.5	0.5
078	1	0.5	2.5	0.5
093	1	1.5	4.5	0.8
125	5	2	5.5	0.8
136	5	2	5.5	0.8
156	5	3	7.5	0.8
187	5	5	11.5	1
250	15	4	9.5	1.7

Assembly Tools

Component Type Number	Tool Number	Component Type Number	Tool Number
062/-	AT 1/01	156/SO/XL	AT 1/02
078/-	AT 1/01	156/-	AT 1/05
093/-	AT 1/11	156/-/CEEL	AT 1/05
125/-	AT 1/05	156/L	AT 1/14
136/SO	AT 1/11	187/-	AT 1/06
136/LP	AT 1/17	250/-	AT 1/07
156/E	AT 1/02	156/LP/B2	AT 1/09
156/20	AT 1/02	LS/B2/156	AT 2/01
156	AT 1/02		ATS 3/05

Assembly Procedure

- 1 Ensure holes are within tolerance and deburred.
- 2 Place bush into hole supporting the chassis underneath and using the appropriate assembly tool, press the spill slowly through the bush until the positive detent action firmly locks the assembly into place.

**Mounting Details and
Shoulder Diameter**

Prefix No.	Mounting Hole Details		Chassis Thickness	Max. Outside Dia. of Bush After Assembly
	ins ± 0.002	mm ± 0.05		
062	0.062	1.57	0.56 mm (0.022") - 0.71 mm (0.028")	2.7 mm (0.106")
078	0.078	1.98	1.2 mm (0.047") - 1.6 mm (0.062")	2.8 mm (0.110")
093	0.093	2.36	2.03 mm (0.08") - 2.3 mm (0.09")	3.6 mm (0.142")
125	0.125	3.18	1.2 mm (0.047") - 1.6 mm (0.062")	5.7 mm (0.224")
136	0.136	3.45	1.2 mm (0.047") - 1.6 mm (0.062")	4.7 mm (0.185")
156	0.156	3.96	1.2 mm (0.047") - 1.6 mm (0.062")	5.4 mm (0.213")
187	0.187	4.75	1.6 mm (0.062") - 2.3 mm (0.09")	7.4 mm (0.291")
250	0.250	6.35	2.3 mm (0.09") - 3.2 mm (0.126")	8.9 mm (0.350")

Chassis Thickness Exceptions

Type	Chassis Thickness
-/10P	2.3 mm (0.09") - 3.2 mm (0.126")
-/16P	1.2 mm (0.047") - 1.6 mm (0.063")
-/18P	0.91 mm (0.036") - 1.2 mm (0.047")
-/20P	0.71 mm (0.028") - 0.91 mm (0.036")
093/20/LP	0.71 mm (0.028") - 0.91 mm (0.036")
093/SO/20LP	0.71 mm (0.028") - 0.91 mm (0.036")

Features

- Simple economical assembly.
- High reliability.
- Low contact resistance.
- High insulation resistance.
- Line and chassis mounting styles.

Application

- Chassis mounting adaptable connections.
- Stackable applications for test purposes.
- PCB edge mounted variations ideal for card rack systems.

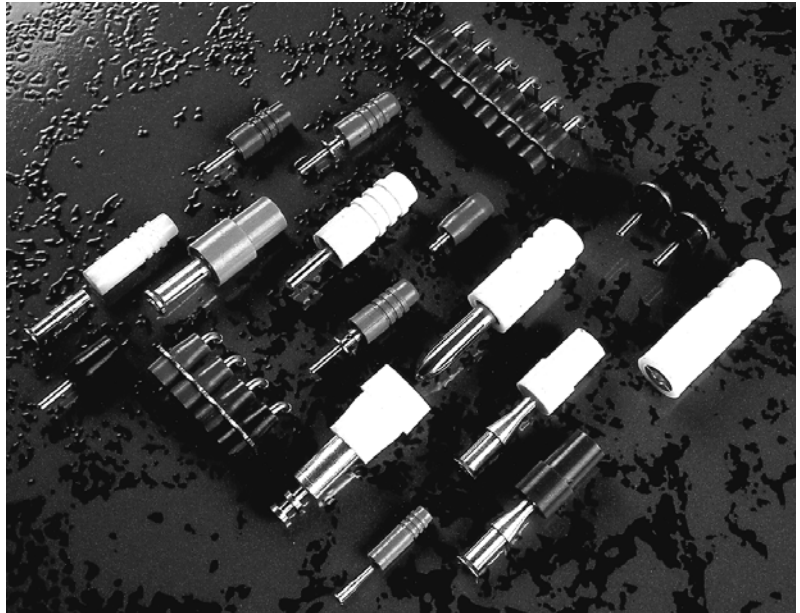

Barb Cone Lock® Plugs and Sockets

Using the same technology as the Barb Cone Lock® Insulated Terminals, this product range utilise High Dispersion Grade PTFE for insulation and reliability.

The range includes chassis mounting plugs and sockets, line plugs and sockets and multiway edge mounting sockets all in a range of diameters from 0.5 mm to 4 mm with current ratings from 1 to 5 Amps. Typical applications are for test equipment and card rack systems in the military, aerospace and nuclear industries and for high voltage applications up to 2 kV.

The simple assembly provides a product with high insulation resistance and low contact resistance.

Standard finishes are Gold flash on a Silver undercoat for the plugs, and Silver on the sockets helping to maintain a low contact resistance performance over many mating cycles. Other finishes are available on request.

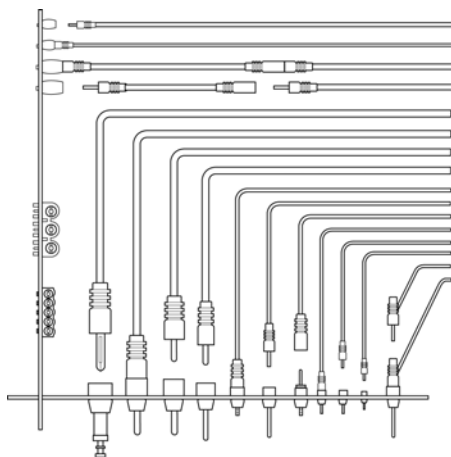

0.55-, 2-, 4- Range

Prefix: 0.55
Mounting Hole Diameter:
 2 mm (0.079")
Nom. Diameter plug and socket:
 0.55 mm (0.022")
Max Wire Diameter:
 Conductor: 0.65 mm (0.025")
 Insulator: 1.15 mm (0.045")
Assembly Tool:
 P/2: AT 1/23
 S/2: AT 2/15

Prefix: 2
Mounting Hole Diameter:
 6 mm (0.236")
Nom. Diameter plug and socket:
 2 mm (0.079")
Max Wire Diameter:
 Conductor: 2.6 mm (0.102")
 Insulator: 3.7 mm (0.146")
Assembly Tool:
 2P/6: AT 1/22 & ATS 3/16
 2S/6: AT 2/13

Prefix: 4
Mounting Hole Diameter:
 8 mm (0.312")
Nom. Diameter plug and socket:
 4 mm (0.157")
Max Wire Diameter:
 Conductor: 2.64 mm (0.104")
 Insulator: 3.8 mm (0.150")
Assembly Tool:
 4P/8: N/A
 4S/8: AT 2/13

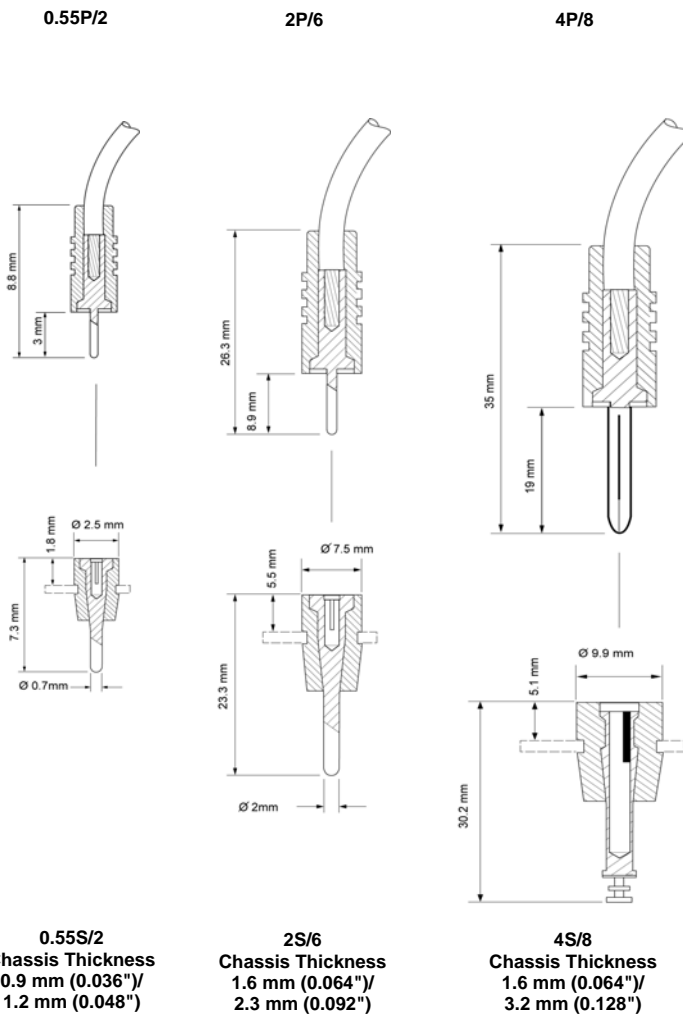

Wires shown for illustration purposes only.

Prefix: 30/-

Mounting Hole Diameter:

2.4 mm (0.093")

Nom Diameter plug and socket:

0.90 mm (0.035")

Max Wire Diameter:

Conductor: 0.80mm (0.031")

Insulator: 1.2 mm (0.047")

Assembly Tool:

30S/093/V, 30S/093/VL: N/A

30S/093: AT 2/12

30S/093, 30LS/093: AT 1/21 & ATS 3/08

Chassis Thickness 0.9 mm 0.036"

Maximum Chassis Thickness:

Type -/V 2.4 mm 0.093"

Type -/VL 4.0 mm 0.156"

(Sockets supplied pre-assembled)

30 Range

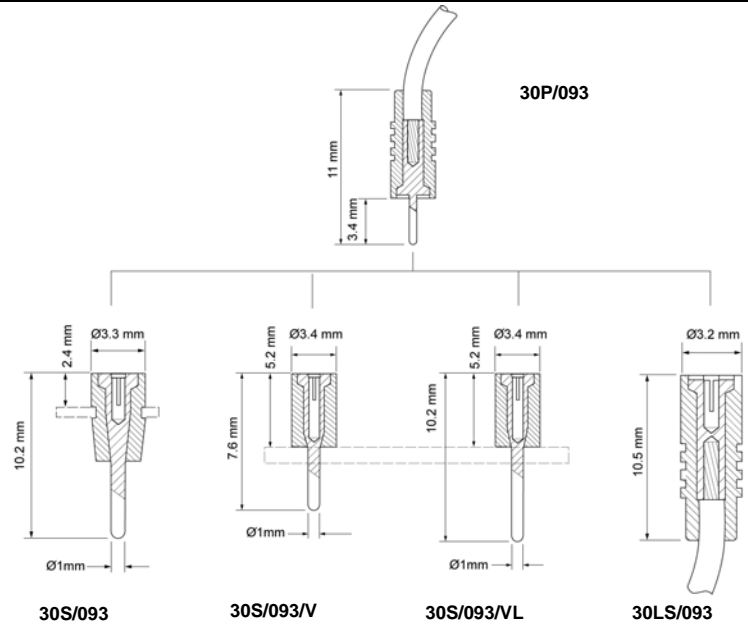

Wires shown for illustration purposes only.

Prefix: 40/-
Nominal Diameter Plug & Socket:
 1.02 mm (0.040")
Mounting Hole Diameter:
 4 mm (0.156")
Maximum Wire Diameter:
 Conductor: 1.6 mm (0.063")
 Insulation: 2 mm (0.079")
Resistance to Axial Pull:
 6.8 kgf (15 lbf)
Capacitance to Chassis (max.):
 1.0 pF
Current Rating: 3 A
Rated Voltage: 2 kV d.c.

Prefix: 50/-
Nominal Diameter Plug & Socket:
 1.27 mm (0.050")
Mounting Hole Diameter:
 4 mm (0.156")
Maximum Wire Diameter:
 Conductor: 1.6 mm (0.063")
 Insulation: 2 mm (0.079")
Resistance to Axial Pull:
 6.8 kgf (15 lbf)
Capacitance to Chassis (max.):
 1.0 pF
Current Rating: 3 A
Rated Voltage: 2 kV d.c.

Prefix: 60/-
Nominal Diameter Plug & Socket:
 1.52 mm (0.060")
Mounting Hole Diameter:
 4 mm (0.156")
Maximum Wire Diameter:
 Conductor: 1.6 mm (0.063")
 Insulation: 2 mm (0.079")
Resistance to Axial Pull:
 6.8 kgf (15 lbf)
Capacitance to Chassis (max.):
 1.0 pF
Current Rating: 3 A
Rated Voltage: 2 kV d.c.

40/50/60 Range

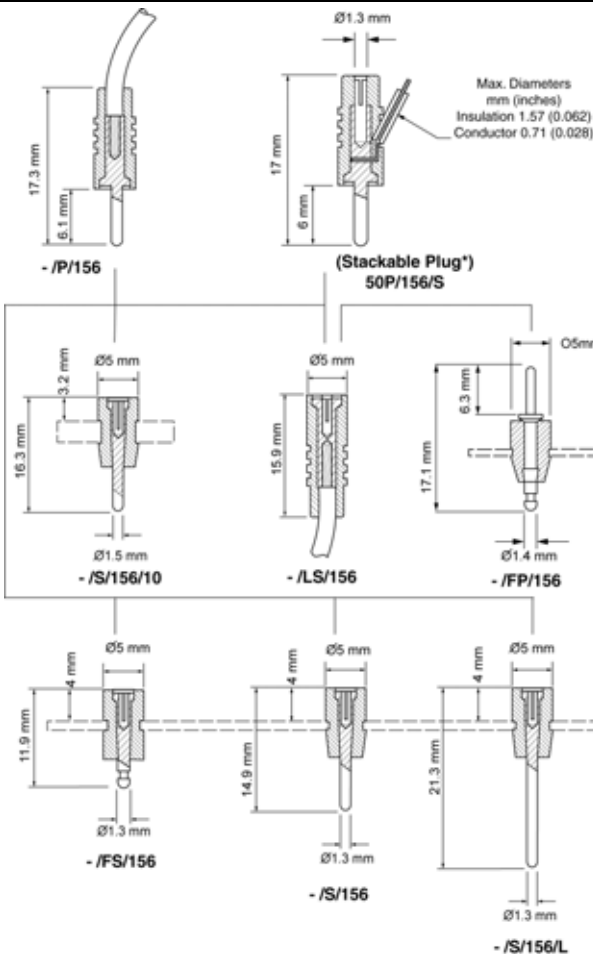

Wires shown for illustration purposes only

Note: Stackable plug 50P/156/S mates with 50S/- type sockets only.

Assembly Tools					
Prefix: 40		Prefix: 50		Prefix: 60	
-P/156:	AT 1/17 & ATS 3/05	-P/156:	AT 1/18 & ATS 3/05	-P/156:	AT 1/19 & ATS 3/05
-FP/156:	AT 1/17	-P/156/S:	AT 1/18	-FP/156:	AT 1/19
-LS/156:	AT 2/08 & ATS 3/05	-LS/156:	AT 2/07 & ATS 3/05	-LS/156:	AT 2/06 & ATS 3/05
-S/156:	AT 2/11	-FP/156:	AT 1/18	-S/156:	AT 2/09
-/-:	AT 2/11	-S/156:	AT 2/10	-/-:	AT 2/09
		-/-:	AT 2/10		

100 Range

Prefix: 100/-

Nominal Diameter Plug & Socket:
2.54 mm (0.100")

Mounting Hole Diameter:
6.4 mm (0.250")

Maximum Wire Diameter:
Conductor: 3.1 mm (0.122")
Insulation: 4.1 mm (0.161")

Resistance to Axial Pull:
15 kgf (30 lbf)

Capacitance to Chassis (max.):
2.0 pF

Current Rating: 5 A

Rated Voltage: 4 kV d.c.

Assembly Tools:
100P-250: AT 1/20 & ATS 3/16
100 FP/250: AT 1/20
100LS/250: AT 2/04 & ATS 3/16
100S/250: AT 2/05

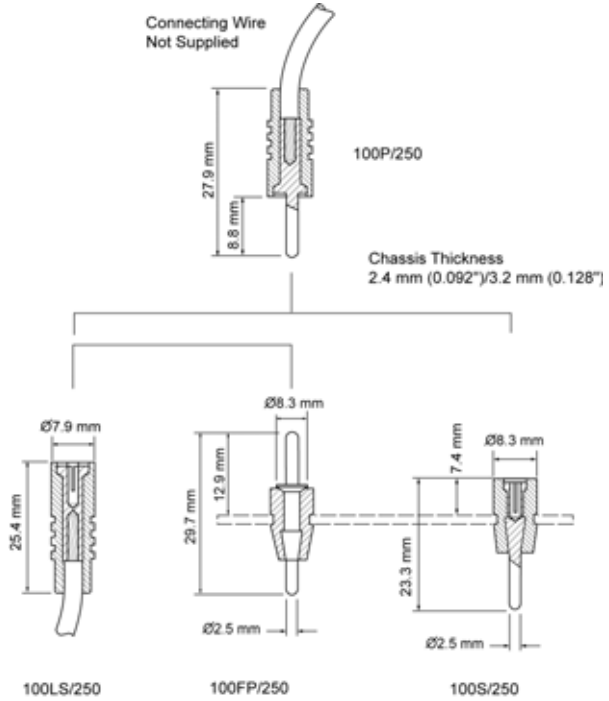

Wires shown for illustration purposes only.

Assembly Tools

Component Type Number	Tool Number	Component Type Number	Tool Number
0.55P/2	AT 1/23	50P/156	AT 1/18 & ATS 3/05
0.55S/2	AT 2/15	50P/156/S	AT 1/18
2P/6	AT 1/22 & ATS 3/16	50FP/156	AT 1/18
2S/6	AT 2/14	50LS/156	AT 2/07 & ATS 3/05
4P/8	N/A	50S/156	AT 2/10
4S/8	AT 2/13	50S/156/V	N/A
30P/093	AT 1/21 & ATS 3/08	50-/-	AT 2/10
30S/093	AT 2/12	60P/156	AT 1/19 & ATS 3/05
30S/093/V	N/A	60FP/156	AT 1/19
30S/093/VL	N/A	60LS/156	AT 2/06 & ATS 3/05
30LS/093	AT 2/12 & ATS 3/08	60S/156	AT 2/09
40P/156	AT 1/17 & ATS 3/05	60S/156/V	N/A
40FP/156	AT 1/17	60-/-	AT 2/09
40LS/156	AT 2/08 & ATS 3/05	100P/250	AT 1/20 & ATS 3/16
40S/156	AT 2/11	100FP/250	AT 1/20
40S/156/V	N/A	100LS/250	AT 2/04 & ATS 3/16
40-/-	AT 2/11	100S/250	AT 2/05

Assembly Procedure - Plugs

1. Thread the connecting wire through the insulating sleeve.
2. Solder the wire into the hole on the probe.
3. Assemble the sleeve and probe with the appropriate insertion tools or by hand.

Assembly Procedure - Sockets

1. Ensure the holes are within tolerance and deburred.
2. Place the bush into the hole. Support the chassis underneath throughout this operation.
3. Using the appropriate assembly tool, slowly press the socket tube into the bush until it is just below the top surface of the bush. Support the chassis underneath throughout this operation.

Oxley Barb Cone Lock self locking plugs and sockets are designed to take advantage of the outstanding electrical and physical properties of high dispersion grade PTFE (polytetrafluorethylene).

The socket contact is slit longitudinally to exploit the inherent elastic of the surrounding PTFE, thus providing the necessary retention and low contact resistance even after repeated insertions.

The chassis mounted connectors are assembled by first inserting the PTFE bush into the mounting hole and then slowly, but firmly, inserting the contact spill through the bush until a positive action firmly locks the assembly in place.

The flying connector is assembled by first threading the PTFE sleeve on to the connecting wire, then soldering the wire in the solder bucket, before pressing home the sleeve onto the spill.

X-ON Electronics

Largest Supplier of Electrical and Electronic Components

Click to view similar products for Oxley manufacturer:

Other Similar products are found below :

[OXL/CLH/100/FL30/GREEN](#) [OXL/CLH/100/12AC/FL30/ALGAAS RED](#) [OXL/CLH/100/230/FL30/GREEN](#)

[OXL/CLH/100/P/24AC/FL30/ALGAAS RED](#) [OXL/CLH/100/24AC/FL30/ALGAAS RED](#) [OXL/CLH/100/24AC/FL30/WHITE](#)

[OXL/CLH/63/FL30/GREEN](#) [DLT/1000/ROHS](#) [FLTM/P/1500/ROHS](#) [OXL/CLH/63/BB/24AC/FL30/GREEN](#) [SN/040/RPL SILVER](#)

[OXL/CLH/100/230/FL30/ALGAAS RED](#) [SN/040/LT/BA SILVER](#) [OXL/CLH/63/24AC/FL30/YELLOW](#)

[OXL/CLH/80/P/12AC/FL30/H/GREEN](#) [LSB2/156/RED](#) [LSB2/156/WHITE](#) [030/30P/KP2 SILVER](#) [DLT/10000/ROHS](#) [028/30P/KP2/L](#)

[SILVER](#) [040/T/KP2 SILVER](#) [SN/040/RP SILVER](#) [LS/B1/093 WHITE](#) [040/30P/KP2 SILVER](#) [SN/040/LT SILVER](#) [FLTM/P/5000/ROHS](#)

[040/30P/KP2/L SILVER](#) [SMOX/060/B1/LP GOLD](#) [040/30P/LA/KP2 SILVER](#) [050/LT/B2](#)