

# Transparent Object (PET Bottle) Detection Compact Photoelectric Sensor E3ZM-B

CSM\_E3ZM-B\_DS\_E\_4\_8

## Excellent PET Bottle Detection



- New detection method that is independent of bottle shape, position, and contents.
- Automatic compensation against effects of contamination and temperature (except E3ZM-B□T).
- Product lineup includes models with adjuster (E3ZM-B□T).
- Detects transparent objects made by PET, resin, and glass.



Refer to *Safety Precautions* on page 10.

For the most recent information on models that have been certified for safety standards, refer to your OMRON website.

## Features

**Industry Top** P-opaquisting and a Coaxial Optical System Eliminate Dependence on the Bottle's Shape, Position, Transparency, and Contents.

**P-opaquisting: Polarization-opaquisting**

**Patented** (Refer to page 9 for a technical description.)

The E3ZM-B more than triples conventional detection performance, with outstanding stability.

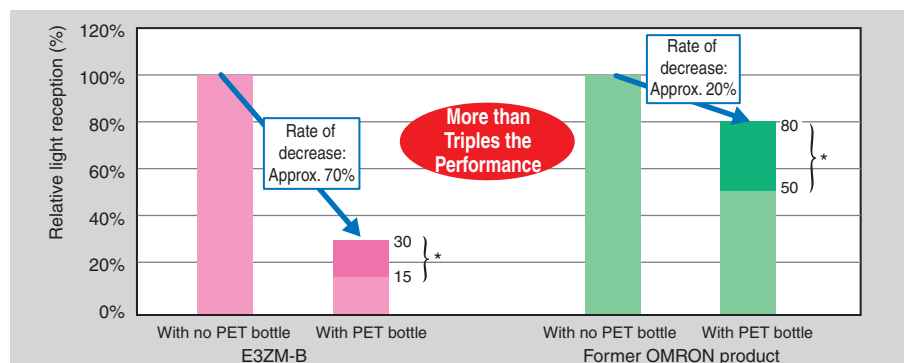

\*Depending on the shape and position of the PET bottle.

**Industry Top** AC<sup>3</sup> Function Automatically Compensates Effects of Soiling and Temperature

**AC<sup>3</sup>: Auto Compensation Control for Contamination**

**Patented** (Refer to page 9 for a technical description.)

Parameters require resetting when static electricity causes dust to adhere to the surface of the Sensor or Reflector, or when the light emission power drops due to temperature- or time-related changes. Original OMRON light emission control technology greatly reduces the resetting work involved.



Initial Condition . . . Contamination . . . Auto Compensation

## Teaching with No Workpiece Required -- Quick and Easy Setting

There is no need for delicate sensitivity adjustments. Simply adjust the optical axes of the Sensor and Reflector, then press the Teaching button twice. This high-reliability design eliminates worries about variations in the sensitivity settings of different operators.



## Industry Top IP69K Degree of Protection with an SUS316L Housing

The housing is constructed of corrosion-resistant SUS316L, and the display cover is PES (polyethersulfone) or PEI (polyetherimide). Both materials are highly resistant to the effects of detergents and disinfectants.

IP69K degree of protection also allows the E3ZM-B to withstand washing with high-temperature, high-pressure water. This makes the E3ZM-B well suited to use in sites requiring a high level of hygiene.



## A Wide Ambient Temperature Range of -40 to 60°C

This wide temperature range meets the needs of the many and diverse applications in the beverage industry.

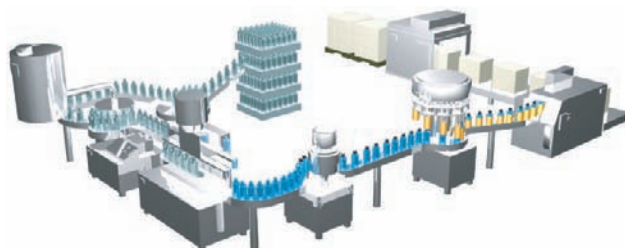

## Applications



Detecting Plastic Bottles

### Precautions for Correct Use

The E3ZM-B□1/B□6 are not applicable for detecting transparent objects that exhibit no birefringence, such as glass bottles. Transparent objects made of resin also exhibit little birefringence, and cannot be detected with complete stability. Check the detection stability of objects such as these prior to actual operation.

## Ordering Information

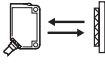
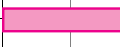

**Sensors** [Refer to *Dimensions* on page 12.]  Red light

Sensing method	Appearance	Sensitivity adjustment	Connection method	Sensing distance				Model			
								Special reflector	NPN output	PNP output	
Retroreflective with MSR function		Teaching type	Pre-wired (2 m)		500 mm	[100 mm]*	Order separately	E3ZM-B61 2M	E3ZM-B81 2M		
			Connector (M8, 4 pins)					E3ZM-B66	E3ZM-B86		
			Pre-wired (2 m)					Included	E3ZM-B61-C 2M	E3ZM-B81-C 2M	
			Connector (M8, 4 pins)						E3ZM-B66-C	E3ZM-B86-C	
			One-turn adjuster type					Pre-wired (2 m)	Order separately	E3ZM-B61T 2M	E3ZM-B81T 2M
								Connector (M8, 4 pins)		E3ZM-B66T	E3ZM-B86T
		Pre-wired (2 m)		Included	E3ZM-B61T-C 2M	E3ZM-B81T-C 2M					
		Connector (M8, 4 pins)			E3ZM-B66T-C	E3ZM-B86T-C					

\*Values in parentheses indicate the minimum required distance between the Sensor and Reflector.

## Accessories

**Special Retroreflective Reflector** (A Retroreflector is provided depending on the model number. Check the model number in the remarks column.) [Refer to *Dimensions* on page 12.]









Name	Model	Sensing distance (rated)				Quantity	Remarks
		E3ZM-B□1(T)/B□6(T)					
Special Polarizing Reflector	E39-RP1		500 mm	[100 mm]*		1	A Reflector is provided with the E3ZM-B□□(T)-C. A Reflector is not provided with the Sensor.
	E39-RSP1		250 mm	[0 mm]*		1	A Reflector is not provided with the Sensor. The MSR function is enabled.
	E39-RP37		250 mm	[0 mm]*		1	A Reflector is not provided with the Sensor. The MSR function is enabled.

Note: Previous OMRON Retroreflective Reflectors (E39-R1/-R1S/-R2/-R3/-R9/-R10/-R1K/-RS1/-RS2/-RS3, etc.) cannot be used with the E3ZM-B.

\*Values in parentheses indicate the minimum required distance between the Sensor and Reflector.

**Mounting Brackets** A Mounting Bracket is not provided with the Sensor. Order a Mounting Bracket separately if required.

[Refer to *Dimensions* on E39-L/E39-S/E39-R, E39-L□.]

Appearance	Model	Quantity	Remarks	Appearance	Model	Quantity	Remarks
	<b>E39-L153</b> (SUS304) *1	1	Mounting Brackets		<b>E39-L98</b> (SUS304) *2	1	Metal Protective Cover Bracket
	<b>E39-L104</b> (SUS304) *1	1			<b>E39-L150</b> (SUS304)	1 set	(Sensor adjuster) Easily mounted to the aluminum frame rails of conveyors and easily adjusted. For vertical angle adjustment
	<b>E39-L43</b> (SUS304) *2	1	Horizontal Mounting Bracket		<b>E39-L151</b> (SUS304)	1 set	Easily mounted to the aluminum frame rails of conveyors and easily adjusted. For vertical angle adjustment
	<b>E39-L142</b> (SUS304) *2	1	Horizontal Protective Cover Bracket				
	<b>E39-L44</b> (SUS304)	1	Rear Mounting Bracket		<b>E39-L144</b> (SUS304) *2	1	Compact Protective Cover Bracket

Note: When using Through-beam models, order one bracket for the Receiver and one for the Emitter.



\*1. Cannot be used for Standard Connector models with mounting surface on the bottom. In that case, use Pre-wired Connector models.

\*2. Cannot be used for Standard Connector models.

### Sensor I/O Connectors (Sockets on One Cable End)

(Models for Connectors: A Connector is not provided with the Sensor. Be sure to order a Connector separately.)

[Refer to *Dimensions* on XS3.]

Size	Specifications	Appearance	Cable	Model	
M8 (4 pins)	Standard	Straight *1 	2 m	4-wire	<b>XS3F-E421-402-A</b>
			5 m		<b>XS3F-E421-405-A</b>
		L-shaped *1 *2 	2 m	4-wire	<b>XS3F-E422-402-A</b>
			5 m		<b>XS3F-E422-405-A</b>

Note: The outer cover of the cable is made of PVC (polyvinyl chloride), the nut is made of SUS316L stainless steel, and the degree of protection is IP67 (IEC 60529).

When high-pressure washing will be used, select an I/O Connector that has IP69K degree of protection.

\*1. The connector will not rotate after connecting.

\*2. The cable is fixed at an angle of 180° from the sensor emitter/receiver surface.

## Ratings and Specifications

Sensing method		Retroreflective with P-opaquing (*1) and MSR functions	
Model	NPN output	E3ZM-B61(-C)/-B66(-C)	E3ZM-B61T(-C)/-B66T(-C) (*2)
Item	PNP output	E3ZM-B81(-C)/-B86(-C)	E3ZM-B81T(-C)/-B86T(-C) (*2)
Sensing distance		100 to 500 mm (Using E39-RP1)	
Standard sensing object		500-ml, transparent, round PET bottle (65-mm dia.)	
Directional angle		Sensor: 3° to 10° Reflector: 30°	
Light source (wavelength)		Red LED (650 nm)	
Power supply voltage		10 to 30 VDC, including 10% ripple (p-p)	
Current consumption		450 mW max. (current consumption for a 30-V power supply voltage: 15 mA max.)	25 mA max.
Control output		Load power supply voltage: 30 VDC max., Load current: 100 mA max. (Residual voltage: 2 V max.) Open-collector output (NPN/PNP output depending on model)	
Operation mode		Light ON/Dark ON cable switch selectable	Light ON/Dark ON switch selectable
Protection circuits		Reversed power supply polarity, Load short-circuit protection, Mutual interference prevention, and Reversed output polarity protection	
Response time		Operate or reset: 1 ms max.	
Sensitivity adjustment		Teaching method	One-turn adjuster
Ambient illumination		Incandescent lamp: 3,000 lx max., Sunlight: 10,000 lx max.	
Ambient temperature range		Operating: -40 to 60°C (*3 *4), Storage: -40 to 70°C (with no icing or condensation)	Operating: -25 to 55°C (*3), Storage: -40 to 70°C (with no icing or condensation)
Ambient humidity range		Operating: 35% to 85%, Storage: 35% to 95% (with no condensation)	
Insulation resistance		20 MΩ min. at 500 VDC	
Dielectric strength		1,000 VAC, 50/60 Hz for 1 min	
Vibration resistance		Destruction: 10 to 55 Hz, 1.5-mm double amplitude for 2 hours each in X, Y, and Z directions	
Shock resistance		Destruction: 500 m/s <sup>2</sup> 3 times each in X, Y, and Z directions	
Degree of protection *5		IEC IP67, DIN 40050-9: IP69K	
Connection method		Pre-wired cable (standard length: 2 m) or M8 4-pin connector	
Indicators		Operation indicator (yellow), Stability indicator (green), and Teaching indicator (red)	
Weight (packed state)		Pre-wired models: Approx. 85 g Connector models: Approx. 35 g	Pre-wired models (2-m cable): Approx. 70 g Connector models: Approx. 20 g
Materials	Housing	SUS316L	
	Lens	PMMA (polymethylmethacrylate)	
	Indication	PES (polyethersulfone)	PEI (Polyetherimide)
	Buttons	Fluoro rubber	
Cable		PVC (polyvinyl chloride)	
Accessories *6		Instruction sheet, Special Reflector (E3ZM-B□□-C only)	

\*1. For information on the P-opaquing function, refer to → pages 1 and 9.

\*2. If a sensing object such as a glass plate is being used, the light reception level may not be attenuated sufficiently.

In the following cases, be sure to test operation sufficiently under actual operating conditions.

1) If the temperature varies more than 5°C

2) If the Sensor or Reflector moves due to vibration

\*3. Do not bend the cable in temperatures of -25°C or lower.

\*4. This value applies when an E39-RP1 Reflector is used.

The ambient operating temperature range when the E39-RSP1 or E39-RP37 is used is -25 to 55°C.

\*5. IP69K Degree of Protection Specification

IP69K is a protection standard against high temperature and high-pressure water defined in the German standard DIN 40050, Part 9. The test piece is sprayed with water at 80°C at a water pressure of 80 to 100 BAR using a specified nozzle shape at a rate of 14 to 16 liters/min.

The distance between the test piece and nozzle is 10 to 15 cm, and water is sprayed horizontally for 30 seconds each at 0°, 30°, 60°, and 90° while rotating the test piece on a horizontal plane.

\*6. Mounting Brackets must be ordered separately.

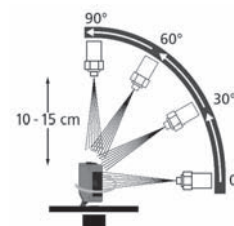

Engineering Data (Reference Value)

Parallel Operating Range (Horizontal)

E3ZM-B□1/B□6 +  
E39-RP1 (Special Reflector)

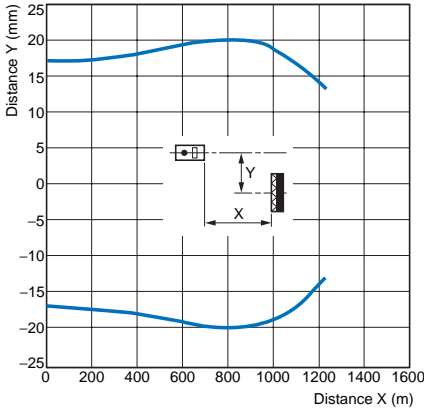

Parallel Operating Range (Vertical)

E3ZM-B□1/B□6 +  
E39-RP1 (Special Reflector)

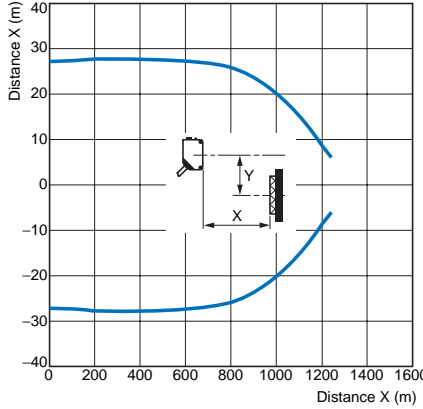

Excess Gain vs. Distance

E3ZM-B□1/B□6 +  
E39-RP1 (Special Reflector)

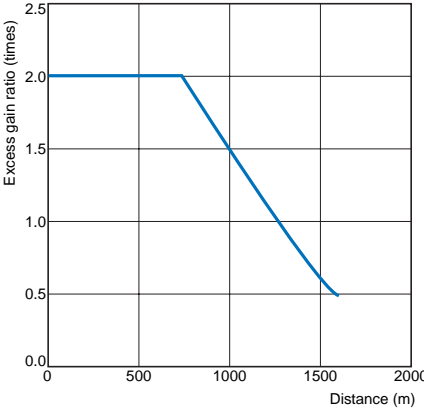

Note: The AC<sup>3</sup> function controls the excess gain ratio to be a constant multiple of 2.

Dark Excess Gain vs. Sensing Object Characteristics

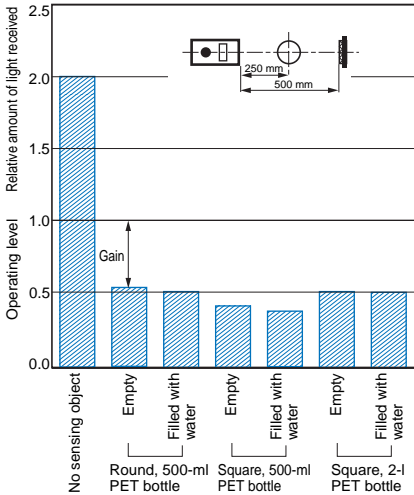

Dark Excess Gain vs. Position

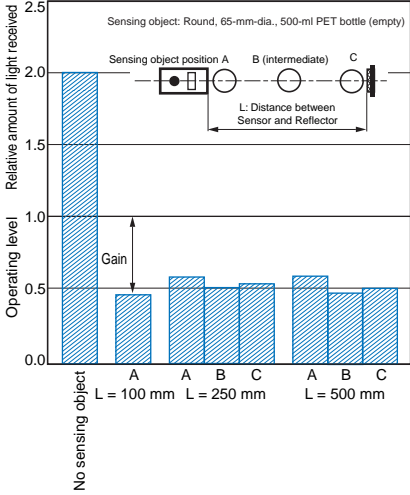

## I/O Circuit Diagrams

### NPN Output

Model	Operation mode	Timing charts	Operation selector switch	Output circuit
E3ZM-B61 E3ZM-B66	Light ON		Connect pink lead (2) to brown lead (1).	
	Dark ON		Connect pink lead (2) to blue lead (3) or leave open.	
E3ZM-B61T E3ZM-B66T	Light ON		L side (LIGHT ON)	
	Dark ON		D side (DARK ON)	

### PNP Output

Model	Operation mode	Timing charts	Operation selector switch	Output circuit
E3ZM-B81 E3ZM-B86	Light ON		Connect pink lead (2) to brown lead (1).	
	Dark ON		Connect pink lead (2) to blue lead (3) or leave open.	
E3ZM-B81T E3ZM-B86T	Light ON		L side (LIGHT ON)	
	Dark ON		D side (DARK ON)	

### Plugs (Sensor I/O Connectors)

#### M8 4-pin Connectors

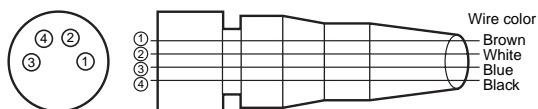

XS3F-E421-402-A    XS3F-E422-402-A  
 XS3F-E421-405-A    XS3F-E422-405-A

Classification	Wire color	Connector pin No.	Application
DC	Brown	1	Power supply (+V)
	White	2	Operation selection *
	Blue	3	Power supply (0 V)
	Black	4	Output

Note: The above M8 Connectors made by OMRON are IP67. Do not use them in an environment where IP69K is required.

\*Not available on the E3ZM-B□□□.



Nomenclature

Teaching Models

E3ZM-B□

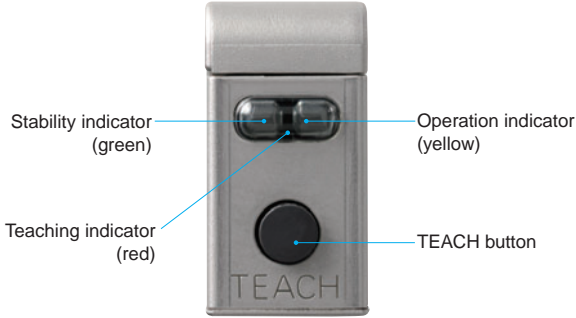

One-turn Adjuster Models

E3ZM-B□T

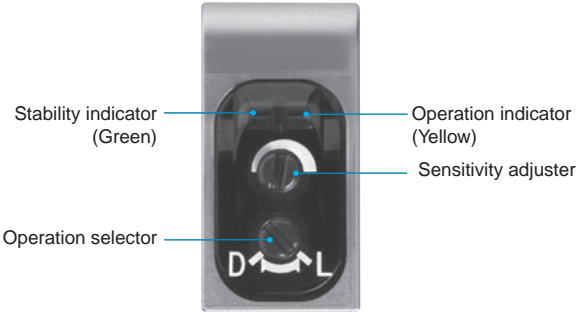

Note: When the Sensor is first unpacked and used, the teaching indicator (red) will flash slowly to show that teaching has not yet been done. This does not indicate a malfunction. Use the following procedure to conduct teaching.

Teaching Method

**1. Install the Sensor and Reflector and adjust the optical axis (without placing a Sensing objects between them). Then press and hold the TEACH button for at least 2 seconds.**

The teaching indicator (red) will start flashing quickly. Perform the following operation within 7 seconds after first starting to press the TEACH button. (After 7 seconds, the Unit will return to its initial condition.)

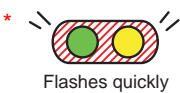

The stability indicator (green) and operation indicator (yellow) will retain their lit or OFF status, and the teaching indicator (red) will flash.

**2. Press the TEACH button again.**  
Teaching will then begin.  
The teaching indicator (red) will remain lit during the teaching operation.



When Teaching Is Successful

The teaching indicator (red) will go out. The Unit will then enter normal operating condition.

Dark ON setting

Light ON setting

When Teaching Is Not Successful

The teaching indicator (red) will flash slowly or quickly.

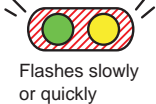

The teaching indicator (red) will then begin flashing even more slowly, indicating that the teaching operation should begin.

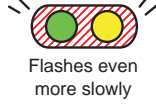

**Repeat the operation starting with step 1.**

Note: Depending on the amount of light received, the operation indicator and stability indicator may also change during the teaching operation.



## Technical Descriptions

### New Technology for Detecting Transparent Objects Exhibiting Birefringence **Patented** **P-opaquing (Polarization-opaquing)**

Conventional photoelectric sensors for detecting PET bottles depend on refraction due to the bottle's shape or on the attenuation of light intensity caused by surface reflection. However, it is difficult to attain a sufficient level of excess gain with these methods.

The E3ZM-B utilizes the birefringent (double refraction) property of PET bottles to dramatically increase the level of excess gain. The polarization component that is disturbed by the PET bottles as they pass along the line is cut by a special and unique OMRON polarization filter. This greatly lowers the intensity of the light received to provide stable detection with simple sensitivity adjustment.

“P-opaquing” is a word that was coined to refer to the process of applying polarization in order to opaque transparent objects that exhibit the property of birefringence.

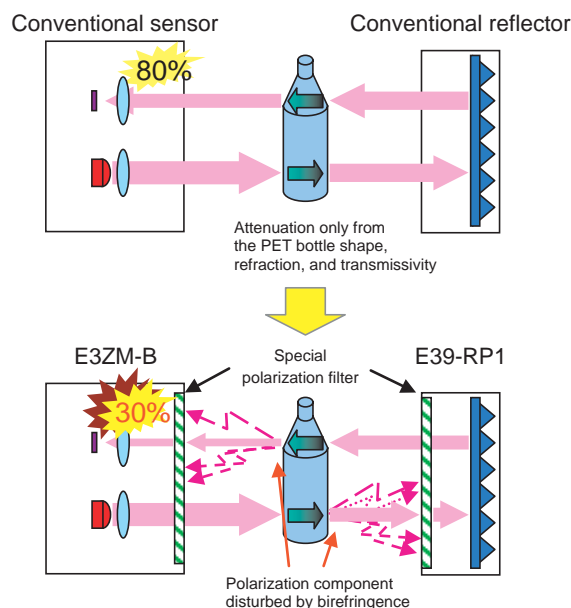

The excess gain of the E3ZM-B is doubled for both light-ON and dark-ON applications.

The excellent stability of the E3ZM-B prevents malfunctions from occurring even if something causes the intensity of light received to fluctuate by  $\pm 50\%$ .

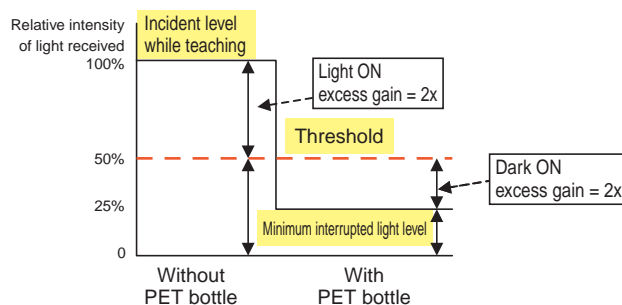

### New Technology for Achieving Long-term Stability **Patented** **AC<sup>3</sup> (AC cube: Auto Compensation Control for Contamination)** (Not available on the E3ZM-B□T)

Conventional photoelectric sensors with built-in amplifiers are not equipped with functions to compensate for changes in the intensity of light received caused by dust and other lens-soiling matter, ambient temperature, and changes that occur in the LED over time. This makes it comparatively difficult to achieve long-term, stable detection of objects that exhibit little change in the intensity of light received, such as transparent objects.

The AC<sup>3</sup> (AC cube) function provided on the E3ZM-B periodically feeds the intensity of light received during light-ON operation back to the light-emitting circuit, to keep the intensity equal to the value set by teaching.

This allows the E3ZM-B to attain long-term, stable detection while helping to cut down on maintenance requirements and improve the equipment operating ratio.

Note: The AC<sup>3</sup> function cannot be used for dark-ON operation.

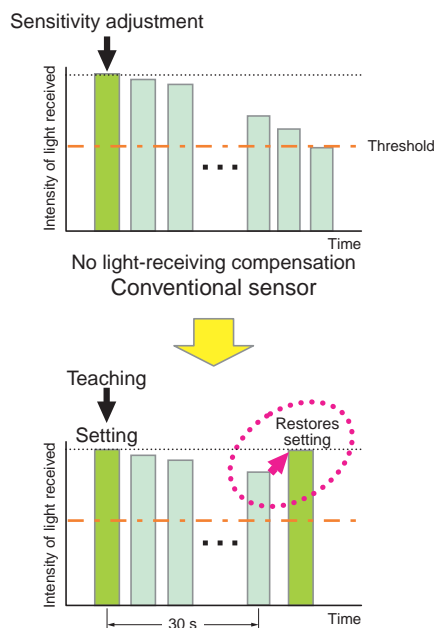

Intensity of light received is compensated every 30 s.  
 E3ZM-B

## Safety Precautions

Refer to *Warranty and Limitations of Liability*.

### WARNING

This product is not designed or rated for directly or indirectly ensuring safety of persons.

Do not use it for such a purpose.



### CAUTION

Do not use the product with voltage in excess of the rated voltage.

Excess voltage may result in malfunction or fire.



Never use the product with an AC power supply.

Otherwise, explosion may result.



When cleaning the product, do not apply a high-pressure spray of water to one part of the product. Otherwise, parts may become damaged and the degree of protection may be degraded.



### Precautions for Safe Use

The following precautions must be observed to ensure safe operation of the Sensor.

#### Operating Environment

Do not use the Sensor in an environment where explosive or flammable gas is present.

#### Connecting Connectors

Be sure to hold the connector cover when inserting or removing the connector.

When using an XS3F Connector, be sure to tighten the connector lock by hand; do not use pliers or other tools. If the tightening is insufficient, the degree of protection will not be maintained and the Sensor may become loose due to vibration. The appropriate tightening torque is 0.3 to 0.4 N·m. When using another, commercially available connector, follow the usage and tightening torque instructions provided by the manufacturer.

#### Load

Do not use a load that exceeds the rated load.

#### Low-temperature Environments

Do not touch the metal surface with your bare hands when the temperature is low. Touching the surface may result in a cold burn.

#### Oily Environments

Do not use the Sensor in oily environments. They may damage parts and reduce the degree of protection.

#### Modifications

Do not attempt to disassemble, repair, or modify the Sensor.

#### Outdoor Use

Do not use the Sensor in locations subject to direct sunlight.

#### Cleaning

Do not use thinner, alcohol, or other organic solvents. Otherwise, the optical properties and degree of protection may be degraded.

#### Cleaning

Do not use highly concentrated cleaning agents. Otherwise, malfunction may result. Also, do not use high-pressure water with a level of pressure that exceeds the stipulated level. Otherwise, the degree of protection may be reduced.

#### Surface Temperature

Burn injury may occur. The Sensor surface temperature rises depending on application conditions, such as the ambient temperature and the power supply voltage. Use caution when operating or performing maintenance on the Sensor.

#### Cable Bending

Do not bend the cable in temperatures of  $-25^{\circ}\text{C}$  or below. Otherwise, the cable may be damaged.

### Precautions for Correct Use

Do not use the Sensor in any atmosphere or environment that exceeds the ratings.

**Do not install the Sensor in the following locations.**

- (1) Locations subject to direct sunlight
- (2) Locations subject to condensation due to high humidity
- (3) Locations subject to corrosive gas
- (4) Locations where the Sensor may receive direct vibration or shock

### Connecting and Mounting

- (1) The maximum power supply voltage is 30 VDC. Before turning the power ON, make sure that the power supply voltage does not exceed the maximum voltage.
- (2) Laying Sensor wiring in the same conduit or duct as high-voltage wires or power lines may result in malfunction or damage due to induction. As a general rule, wire the Sensor in a separate conduit or use shielded cable.
- (3) Use an extension cable with a minimum thickness of 0.3 mm<sup>2</sup> and less than 100 m long.
- (4) Do not pull on the cable with excessive force.
- (5) Pounding the Photoelectric Sensor with a hammer or other tool during mounting will impair water resistance. Also, use M3 screws.
- (6) Mount the Sensor either using the bracket (order separately) or on a flat surface.
- (7) Be sure to turn OFF the power supply before inserting or removing the connector.

### Power Supply

If a commercial switching regulator is used, ground the FG (frame ground) terminal.

### Power Supply Reset Time

The Sensor will be able to detect objects 100 ms after the power supply is turned ON. Start using the Sensor 100 ms or more after turning ON the power supply. If the load and the Sensor are connected to separate power supplies, be sure to turn ON the Sensor first.

### Turning OFF the Power Supply

Output pulses may be generated even when the power supply is OFF. Therefore, it is recommended to first turn OFF the power supply for the load or the load line.

### Load Short-circuit Protection

This Sensor is equipped with load short-circuit protection, but be sure to not short circuit the load. Be sure to not use an output current flow that exceeds the rated current. If a load short circuit occurs, the output will turn OFF, so check the wiring before turning ON the power supply again. The short-circuit protection circuit will be reset. The load short-circuit protection will operate when the current flow reaches 1.8 times the rated load current. When using a capacitive load, use an inrush current of 1.8 times the rated load current or lower.

### Water Resistance

Do not use the Sensor in water, rainfall, or outdoors.

**When disposing of the Sensor, treat it as industrial waste.**

### Mounting Diagram

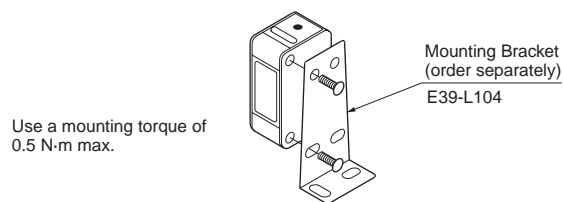

### Resistance to Detergents, Disinfectants, and Chemicals

- The Sensor will maintain sufficient performance in typical detergents and disinfectants, but performance may suffer in some types of detergents, disinfectants, and chemicals. Refer to the following table prior to use.
- The E3ZM has passed detergent and disinfectant resistance testing for the substances listed in the following table. Use this table as a guide when considering detergents and disinfectants.

Type	Product name	Concentration	Temperature	Time
Chemicals	Sodium hydroxide, NaOH	1.5%	70°C	240 h
	Potassium hydroxide, KOH	1.5%	70°C	240 h
	Phosphoric acid, H <sub>3</sub> PO <sub>4</sub>	2.5%	70°C	240 h
	Sodium hypochlorite, NaClO	0.3%	25°C	240 h
	Hydrogen peroxide, H <sub>2</sub> O <sub>2</sub>	6.5%	25°C	240 h
Alkaline foaming cleansers	Topax 66s (Ecolab)	3.0%	70°C	240 h
Acidic foaming cleansers	Topax 56 (Ecolab)	5.0%	70°C	240 h
Disinfectants	Oxonia Active 90 (Ecolab)	1.0%	25°C	240 h
	TEK121 (ABC Compounding)	1.1%	25°C	240 h

Note: The Sensor was immersed in the above chemicals, detergents, and disinfectants for 240 h at the temperatures given, and then passed an insulation resistance test at 100 MΩ min.

Dimensions

Sensors

Retro-reflective Models

Pre-wired Models

- E3ZM-B61
- E3ZM-B81

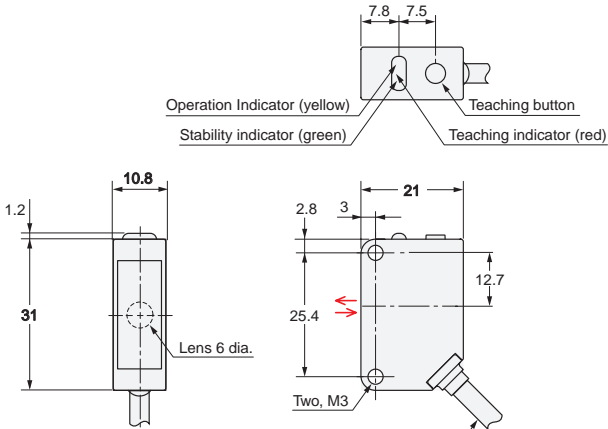

4 dia. vinyl-insulated round cable with 4 conductors (Conductor cross section:0.2 mm<sup>2</sup> (AWG24), Insulator diameter:1.1 mm), Standard length: 2 m

Retro-reflective Models

M8 Connector

- E3ZM-B66
- E3ZM-B86

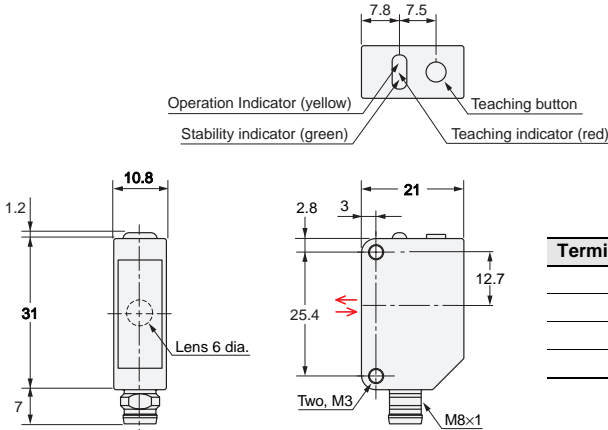

Terminal No.	Specifications
1	+V
2	Operation selection
3	0 V
4	Output

## Retro-reflective Models

### Pre-wired Models

E3ZM-B61T(-C)

E3ZM-B81T(-C)

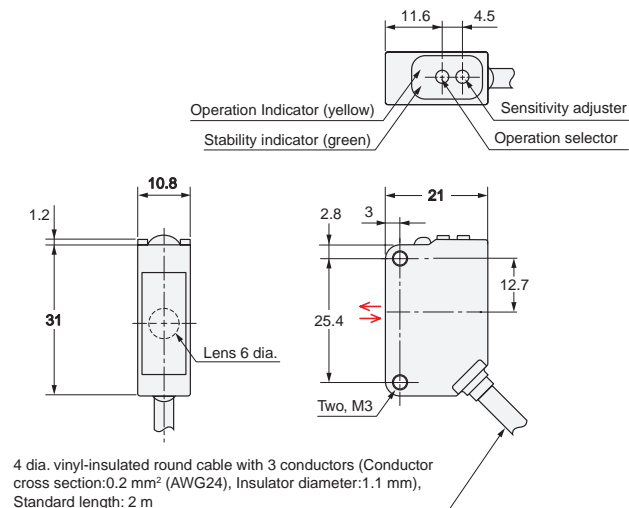

## Retro-reflective Models

### M8 Connector

E3ZM-B66T(-C)

E3ZM-B86T(-C)

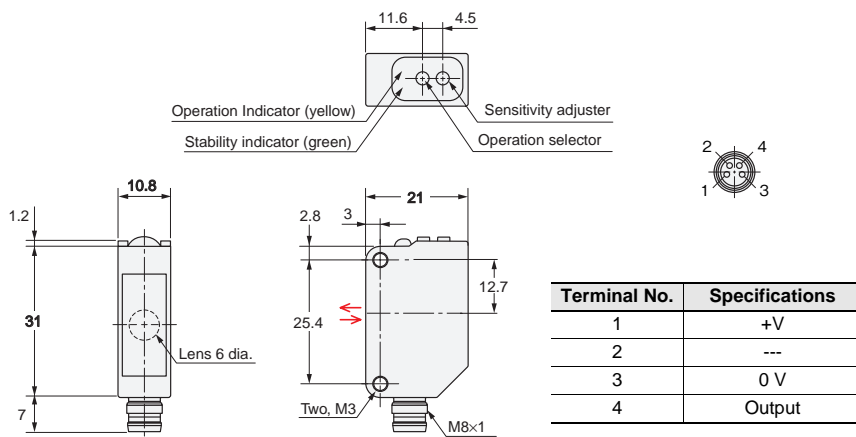

Accessory

Special Retroreflective Reflector E39-RP1

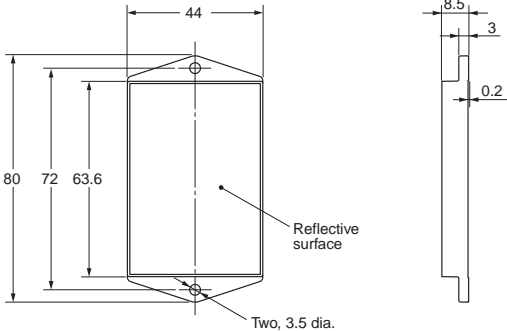

Material: <Reflective surface> acrylic  
<Rear surface> ABS

Special Retroreflective Reflector E39-RP37

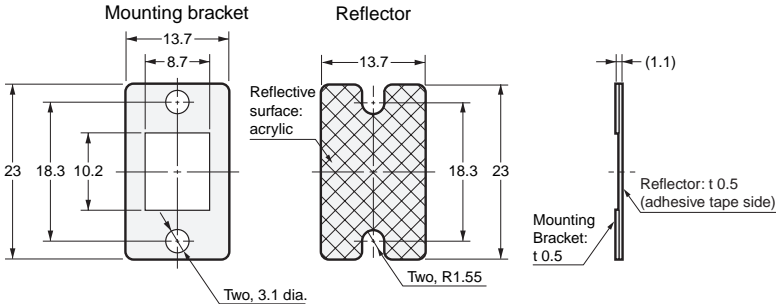

Material: <Reflective surface> acrylic  
<Mounting plate> stainless steel (SUS301)

Note: The reflective plate and mounting plate (1) come as a set.

Special Retroreflective Reflector E39-RSP1

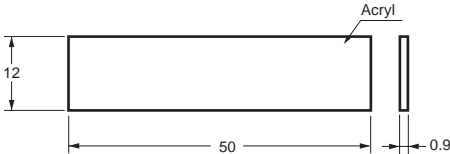

## Terms and Conditions Agreement

### Read and understand this catalog.

Please read and understand this catalog before purchasing the products. Please consult your OMRON representative if you have any questions or comments.

### Warranties.

(a) Exclusive Warranty. Omron's exclusive warranty is that the Products will be free from defects in materials and workmanship for a period of twelve months from the date of sale by Omron (or such other period expressed in writing by Omron). Omron disclaims all other warranties, express or implied.

(b) Limitations. OMRON MAKES NO WARRANTY OR REPRESENTATION, EXPRESS OR IMPLIED, ABOUT NON-INFRINGEMENT, MERCHANTABILITY OR FITNESS FOR A PARTICULAR PURPOSE OF THE PRODUCTS. BUYER ACKNOWLEDGES THAT IT ALONE HAS DETERMINED THAT THE PRODUCTS WILL SUITABLY MEET THE REQUIREMENTS OF THEIR INTENDED USE.

Omron further disclaims all warranties and responsibility of any type for claims or expenses based on infringement by the Products or otherwise of any intellectual property right. (c) Buyer Remedy. Omron's sole obligation hereunder shall be, at Omron's election, to (i) replace (in the form originally shipped with Buyer responsible for labor charges for removal or replacement thereof) the non-complying Product, (ii) repair the non-complying Product, or (iii) repay or credit Buyer an amount equal to the purchase price of the non-complying Product; provided that in no event shall Omron be responsible for warranty, repair, indemnity or any other claims or expenses regarding the Products unless Omron's analysis confirms that the Products were properly handled, stored, installed and maintained and not subject to contamination, abuse, misuse or inappropriate modification. Return of any Products by Buyer must be approved in writing by Omron before shipment. Omron Companies shall not be liable for the suitability or unsuitability or the results from the use of Products in combination with any electrical or electronic components, circuits, system assemblies or any other materials or substances or environments. Any advice, recommendations or information given orally or in writing, are not to be construed as an amendment or addition to the above warranty.

See <http://www.omron.com/global/> or contact your Omron representative for published information.

### Limitation on Liability; Etc.

OMRON COMPANIES SHALL NOT BE LIABLE FOR SPECIAL, INDIRECT, INCIDENTAL, OR CONSEQUENTIAL DAMAGES, LOSS OF PROFITS OR PRODUCTION OR COMMERCIAL LOSS IN ANY WAY CONNECTED WITH THE PRODUCTS, WHETHER SUCH CLAIM IS BASED IN CONTRACT, WARRANTY, NEGLIGENCE OR STRICT LIABILITY.

Further, in no event shall liability of Omron Companies exceed the individual price of the Product on which liability is asserted.

### Suitability of Use.

Omron Companies shall not be responsible for conformity with any standards, codes or regulations which apply to the combination of the Product in the Buyer's application or use of the Product. At Buyer's request, Omron will provide applicable third party certification documents identifying ratings and limitations of use which apply to the Product. This information by itself is not sufficient for a complete determination of the suitability of the Product in combination with the end product, machine, system, or other application or use. Buyer shall be solely responsible for determining appropriateness of the particular Product with respect to Buyer's application, product or system. Buyer shall take application responsibility in all cases.

NEVER USE THE PRODUCT FOR AN APPLICATION INVOLVING SERIOUS RISK TO LIFE OR PROPERTY OR IN LARGE QUANTITIES WITHOUT ENSURING THAT THE SYSTEM AS A WHOLE HAS BEEN DESIGNED TO ADDRESS THE RISKS, AND THAT THE OMRON PRODUCT(S) IS PROPERLY RATED AND INSTALLED FOR THE INTENDED USE WITHIN THE OVERALL EQUIPMENT OR SYSTEM.

### Programmable Products.

Omron Companies shall not be responsible for the user's programming of a programmable Product, or any consequence thereof.

### Performance Data.

Data presented in Omron Company websites, catalogs and other materials is provided as a guide for the user in determining suitability and does not constitute a warranty. It may represent the result of Omron's test conditions, and the user must correlate it to actual application requirements. Actual performance is subject to the Omron's Warranty and Limitations of Liability.

### Change in Specifications.

Product specifications and accessories may be changed at any time based on improvements and other reasons. It is our practice to change part numbers when published ratings or features are changed, or when significant construction changes are made. However, some specifications of the Product may be changed without any notice. When in doubt, special part numbers may be assigned to fix or establish key specifications for your application. Please consult with your Omron's representative at any time to confirm actual specifications of purchased Product.

### Errors and Omissions.

Information presented by Omron Companies has been checked and is believed to be accurate; however, no responsibility is assumed for clerical, typographical or proofreading errors or omissions.



## X-ON Electronics

Largest Supplier of Electrical and Electronic Components

*Click to view similar products for [Photoelectric Sensors](#) category:*

*Click to view products by [Omron](#) manufacturer:*

Other Similar products are found below :

[E3JM-DS70R4T-US](#) [E3L2DC4](#) [E3RA-DN12 2M](#) [E3RA-DP12 2M](#) [E3S5LE4S](#) [E3S-AD38](#) [E3S-CR11 5M](#) [E3SCT11D5M](#) [E3SCT11M1J03M](#)  
[E3T-CT22S](#) [E3T-FD12R](#) [E3T-SL14R](#) [E3T-SL24 5M](#) [E3T-ST12R](#) [E3T-ST24 2M](#) [E3X-CN02](#) [E3X-CN11 5M](#) [E3X-CN21 10M](#) [E3ZM-B66](#)  
[E3ZM-CL81H 2M](#) [E3Z-T62 2M](#) [NJL5303R-TE1](#) [PB10CNT15PO](#) [PD60CNX20BP](#) [FZS](#) [CX-491-P-J](#) [CX-491-Z](#) [XUM2BKCNL2T](#)  
[XUM2BKCNL2T](#) [XUM2BNANL2R](#) [Y92E-ES30M](#) [Y92E-GS08SS](#) [ZXTDS04T](#) [ZX-XC4A 4M](#) [E3E23Y2US](#) [E3JM-DS70S4-US](#) [E3RA-](#)  
[RN11 2M](#) [E3S5LE42M](#) [E3S-LS20XB4 5M](#) [E3S-LS3PW 2M](#) [E3TFD14N](#) [E3T-FD14R](#) [E3T-SL21 5M](#) [E3T-SL21M](#) [E3T-ST11R](#) [E3T-ST12](#)  
[5M](#) [E3X-DA41-S-M1J 0.3M](#) [E3X-DAB6](#) [E3X-DAG8](#) [E3ZM-B86](#)