

Inductive sensor
With increased switching distance
BI2-EG08-AP6X-V1131

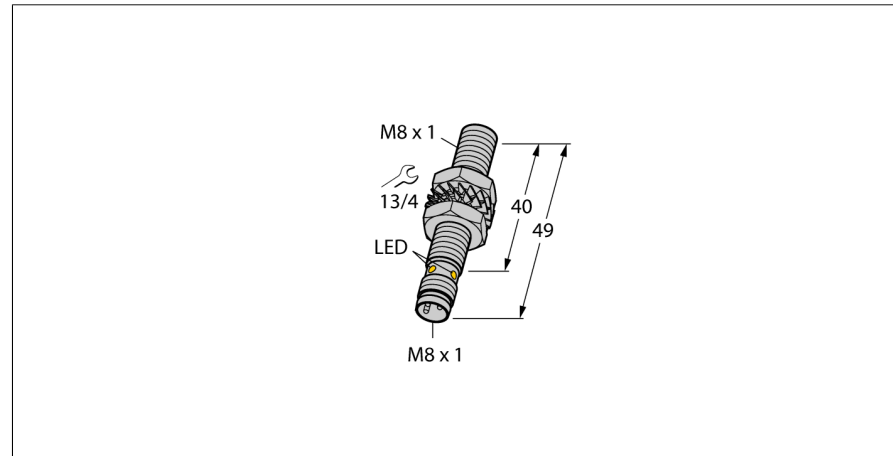

- Threaded barrel, M8 x 1
- Stainless steel, 1.4427 SO
- Large sensing range
- DC 3-wire, 10...30 VDC
- NO contact, PNP output
- M8 x 1 male connector

Wiring Diagram

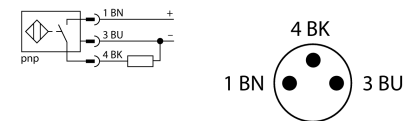

Type designation	BI2-EG08-AP6X-V1131
Ident no.	4602050
Rated switching distance Sn	2 mm
Mounting conditions	Flush
Secured operating distance	≤ (0,81 x Sn) mm
Correction factors	St37 = 1; Al = 0.3; stainless steel = 0.7; Ms = 0.4
Repeat accuracy	≤ 2 % of full scale
Temperature drift	≤ ± 10 %
Hysteresis	3...15 %
Ambient temperature	-25...+70 °C
Operating voltage	10...30 VDC
Residual ripple	≤ 10 % U _{ss}
DC rated operational current	≤ 150 mA
No-load current I ₀	≤ 15 mA
Residual current	≤ 0.1 mA
Isolation test voltage	≤ 0.5 kV
Short-circuit protection	yes/ Cyclic
Voltage drop at I ₀	≤ 1.8 V
Wire breakage/Reverse polarity protection	yes/ Complete
Output function	3-wire, NO contact, PNP
Switching frequency	3 kHz
Design	Threaded barrel, M8 x 1
Dimensions	49 mm
Housing material	Stainless steel, 1.4427 SO
Active area material	Plastic, PA12-GF30
Max. tightening torque housing nut	5 Nm
Electrical connection	Connector, M8 x 1
Vibration resistance	55 Hz (1 mm)
Shock resistance	30 g (11 ms)
Protection class	IP67
MTTF	2283 years acc. to SN 29500 (Ed. 99) 40 °C
Switching state	LED yellow

Functional principle

Inductive sensors detect metal objects contactless and wear-free. For this, they use a high-frequency electromagnetic AC field that interacts with the target. Inductive sensors generate this field via an RLC circuit with a ferrite coil.

Inductive sensor
With increased switching distance
BI2-EG08-AP6X-V1131

Distance D	2 x B
Distance W	3 x Sn
Distance T	3 x B
Distance S	1.5 x B
Distance G	6 x Sn
<hr/>	
Diameter active area B	Ø 8 mm



**Inductive sensor
With increased switching distance
BI2-EG08-AP6X-V1131**

Accessories

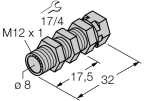
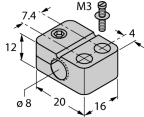
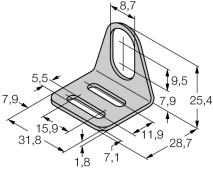
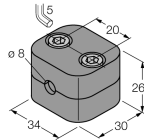
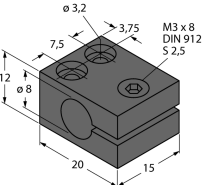
Type code	Ident no.	Description	
QM-08	6945100	Quick-mount bracket with dead-stop, chrome-plated brass, male thread M12 x 1. Note: The switching distance of proximity switches may be reduced through the use of quick-mount brackets.	
BST-08B	6947210	Fixing clamp for threaded barrel devices, with dead-stop; material: PA6	
MW-08	6945008	Mounting bracket for threaded barrel devices; material: Stainless steel A2 1.4301 (AISI 304)	
BSS-08	6901322	Mounting bracket for smooth and threaded barrel devices; material: Polypropylene	
MBS80	69479	Mounting bracket for threaded barrel devices; material mounting block: Anodized aluminium	

Inductive sensor
With increased switching distance
BI2-EG08-AP6X-V1131

Wiring accessories

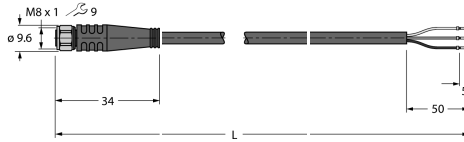
Type code	Ident no.	Description	
PKG3M-2/TEL	6625385	Connection cable, female M8, straight, 3-pin, stainless steel coupling nut, cable length: 2 m, sheath material: PVC, black; cULus approval; other cable lengths and qualities available, see www.turck.com	

X-ON Electronics

Largest Supplier of Electrical and Electronic Components

Click to view similar products for [Turck manufacturer](#):

Other Similar products are found below :

[BI10-M30-AP6X-H1141](#) [BI2-G12-AZ33X-7M](#) [BS4151-0/13.5](#) [NI12U-G18-ADZ30X2-B1331](#) [NI12U-M18-AN4X](#) [BI1.5-G08K-AN6X](#) [BI5-G18-AZ3X](#) [BI5-G18-AZ3X-B1331-50MM](#) [VB20](#) [BMWS 8151-0/9](#) [NI4U-EG08-AN6X-H1341](#) [BC 5-Q08-AP6X2-V1131](#) [NI5-G12-AP6X-H1141](#) [NI14-G18-ADZ30X2](#) [BI5-G18-Y0](#) [C2-A20DX/024VDC](#) [NI35U-CK40-ADZ30X2-B3131](#) [W/BS4](#) [RK40-2M](#) [BI5-G18-AP6X-B1441/S34](#) [RSM FKM RKM 57](#) [BC5-S18-Y1X](#) [FEN20-4DIP-4DXP-DIN](#) [BCF5-S18-RP4X/S90](#) [BI5-M18-AZ3X/S120](#) [BI2-G08-AN6X](#) [NI12U-MT18-AP4X-H1141](#) [BI8U-Q10-AP6X2-V1131](#) [CT 2-A30/M](#) [PT-30HG-13-LI3-H1131](#) [FCS-N1/2A4P-AP8X-H1141](#) [B1N360V-Q20L60-2LU3-H1151](#) [CMBS 8141-0](#) [BI10-M30-AN6X-H1141](#) [CMB 8151-0](#) [RK 4.5T-10](#) [VB80-P7X9-8/CS12](#) [NI12U-M18-AP6X-H1141](#) [RK 4T-6](#) [BS 4131-0/9](#) [B 4241-0/9](#) [NI3-EG08K-Y1-H1341](#) [RK 4.4T-10](#) [RI360P0-QR24M0-INCRX2-H1181](#) [BI10U-Q14-AP6X2-V1131](#) [FDN20-4S-4XSG-E](#) [FKV-CC](#) [FSFD 8](#) [NI4U-EG08-RP6X-V1131](#) [RK 4.4T-8](#) [NI8-M18E-VN4X](#)