

DIN 41612

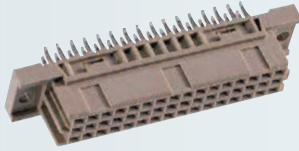

Type C/2 Female Connector



Type: Female connector straight with 3 rows

Termination: Press-fit, solder, THTR

Number of contacts: 16, 32, 48

Pitch: 2.54 mm

Operational current: 1.5 A

Packaging: Tray

Standard: IEC 60603-2



Technical Specifications on page 36

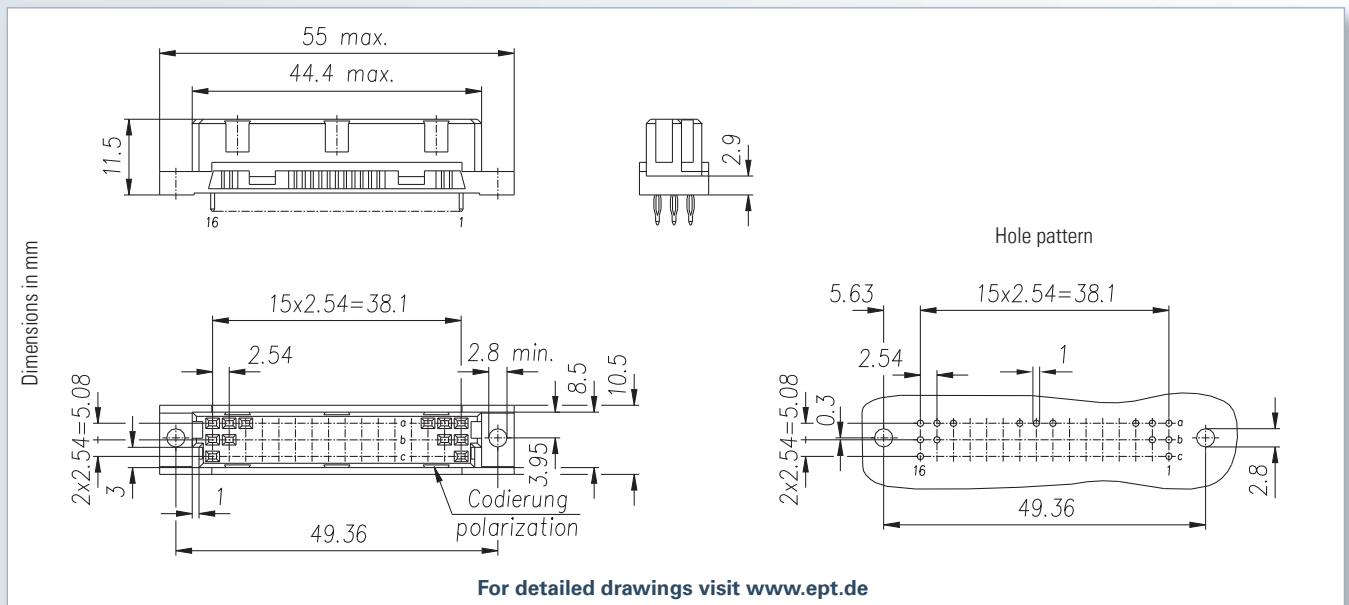

Accessories

- Processing tools p. 300
- Coding p. 132



Mating connector / Application:

 Type C/2 Male connector (p. 56)

 Type R/2 Male connector (p. 78)

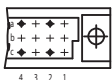
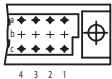

Press-fit - Performance level II



No. of contacts	Contact arrangement	PCB thickness	Termination length L 			
			3.2 mm	4.6 mm	13 mm	17 mm
			Part number			
16		1.5 - 2.0 mm	104-69004-01	-	104-79006-01	104-79106-01
		2.0 - 2.8 mm	-	104-69004-02	104-79006-02	104-79106-02
		> 2.8 mm	-	104-69004-03	104-79006-03	104-79106-03
32		> 1.5 mm	-	304-69014-02	304-79016-03	304-79116-04
48		> 1.5 mm	-	304-69064-02	304-79066-03	304-79166-04

On request

- performance level I + III or customized
- special contact length
- alternative contact surface Sn e. g. for WireWrap
- without flange
- contact arrangement

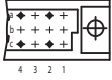

Solder - Performance level II

No. of contact	Contact arrangement	Termination length L 				
		2.5 mm	3.4 mm	4.6 mm	13 mm	5.5 mm <small>Manual soldering with solder lug</small>
		Part number				
16		104-90004	-	-	104-90006	104-90025
32		304-90014-05	304-90014-01	304-90014-02	304-90016-03	104-90035
48		304-90064-05	304-90064-01	304-90064-02	304-90066-03	104-90075

On request

- performance level I + III or customized
- special contact length
- other termination lengths in THTR
- Board-Lock p. 131
- contact arrangement

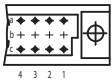
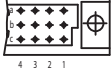

THTR - Performance level II

No. of contacts	Contact arrangement	Termination length L 		
		2.5 mm	3.4 mm	4.6 mm
		Part number		
32		304-90014-05TH	304-90014-01TH	304-90014-02TH
48		304-90064-05TH	304-90064-01TH	304-90064-02TH

X-ON Electronics

Largest Supplier of Electrical and Electronic Components

Click to view similar products for [EPT manufacturer](#):

Other Similar products are found below :

[111-40064](#) [104-49054](#) [112-40065](#) [D2LS-A](#) [404-52040-51](#) [114-40050](#) [104-80075](#) [108-40064](#) [101-40064](#) [FS-IR12B](#) [102-90065](#) [243-11322-15](#) [104-40075](#) [FS-IR02B](#) [403-51040-51](#) [114-40090](#) [113-40010](#) [FS-IR82B](#) [962-40206-03](#) [243-23320-15](#) [FS-IR32D](#) [FS-IR42B-45025XH](#) [116-90064](#) [TS-IR05](#) [962-60326-12](#) [102-80065](#) [244-11000-15](#) [244-62300-15](#) [D1CS-D](#) [304-40064-01](#) [114-40040](#) [TS-IR03](#) [112-40064](#) [401-51501-51](#) [101-80014](#) [107-40064](#) [244-23300-15](#) [402-51501-51](#) [114-40080](#) [401-55501-51](#) [109-40064](#) [110-40584](#) [115-40074](#) [404-51050-51](#) [404-53032-51](#) [403-52012-51](#) [113-40060](#) [107-40065](#) [243-22310-15](#) [403-51050-51](#)