

Three Phase Solid State Relays

SIT865990
24-520 VAC - 3 x 50A
(AC-51 : 3 x 22 ARMS)
(AC-53 : 3 x 12 ARMS)

- Solid State Relay for all type of loads with integrated heatsink
- DIN rail or panel mounting
- Back to back thyristors with TMS² technology
- 50A Thyristors size with $I^2t > 1500A^2s$ (*)
- 90-240VAC control voltage with input status LED
- RC+ Overvoltage protection by integrated VDR
- IP20
- Designed in conformity with UL, EN60950 and IEC60947-4-3
- No tool needed for mounting and dismounting or
 DIN rail or direct mounting on panel

(*) : on request : model with I^2t 5000A²s up to 20000A²s

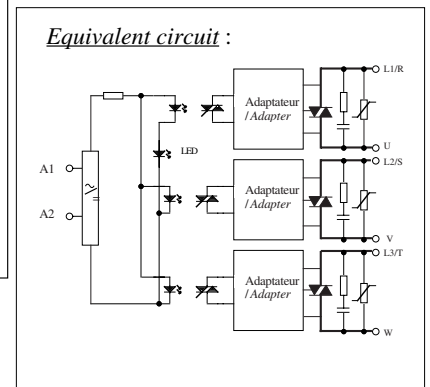
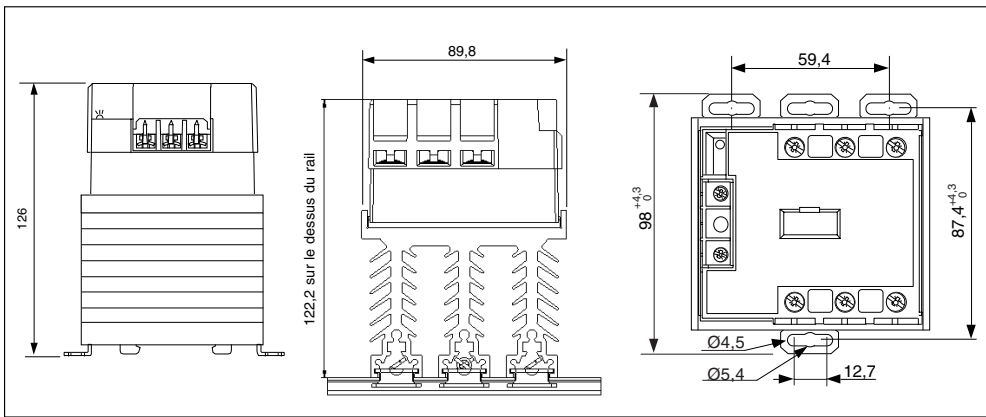

Caractéristiques de commande (à 20°C) / Control characteristics (at 20°C)

Paramètre / Parameter	Symbol	AC-DC			Unit
		Min	Nom	Max	
Tension de commande / Control voltage : DC	Uc	90		240	VDC
Tension de commande / Control voltage : AC	Uc	90		240	VAC
Courant de commande / Control current (@ Uc)	Ic	4,5		11	mA
Tension de relachement/Release voltage	Uc off	15			V
Résistance interne / Input internal resistor fig.1	Rc		21		KΩ
Tension inverse / Reverse voltage	Urv	polarity free			V

Caractéristiques d'entrée-sortie (à 20°C) / Input-output characteristics (at 20°C)

Isolement entrée-sortie/Input-output isolation @500m	Ui		4000		VRMS
Isolement sortie-semelle/Output-case isolation @500m	Ui		3300		VRMS
Tension assignée isolement/ Rated impulse voltage	Uimp		4000		V

General characteristics

Parameter	Conditions	Symbol	Typ.	Unit
Poids/Weight			1000	g
Storage temperature range			-40 / +100	°C
Operating temperature range			-40 / +80	°C

fig. 1 :Caractéristique d'entrée /

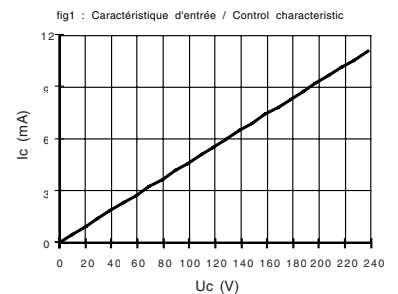

Proud to serve you

Output characteristics (at 20 °C)

Parameter	Conditions	Symbol	Value	Unit
Load voltage		Ue	400	V rms
Minimum Operating range		Uemin	24	V rms
Maximum Operating range	(480Vrms + 10%)	Uemax	520 (*)	V rms
Peak voltage		Up	1200 (*)	V
(*) Clamping voltage	by VDR	Uclamp	850	V
Synchronizing level		Usync	12	V
Latching voltage	Ie nom	Ua	10	V
AC-51 no permanent nominal current	(see Fig. 2)	Ie AC-51	3x50	A rms
AC-51 nominal current	(see Fig. 2)	Ie AC-51	3x22	A rms
AC-53 nominal current		Ie AC-53	3x12	A rms
Non repetitive overload current	tp=10ms (Fig. 3)	Itsm	550 (typ 720)	A
On state voltage drop	@ Ie nom	Vd	1,4	V
Off state leakage current	@Ue, 50Hz	Ilk	1	mA
Minimum load current		Ie min	5	mA
Turn on time	Uc nom DC ,f=50Hz	ton max	30	ms
Turn off time	Uc nom DC ,f=50Hz	toff max	30	ms
Operating frequency range		f	10-400	Hz
Off state dv/dt		dv/dt	500	V/μs
Maximum di/dt non repetitive		di/dt	50	A/μs
I2t (<10ms)		I2t	1500 (typ 2600)	A2s
Conducted immunity level in conformity with IEC 1000-4-4 (burst)	IEC 1000-4-4 (burst)		2kV criterion B	
Conducted immunity level in conformity with IEC 1000-4-5(schocks)	IEC 1000-4-5(schocks)		2kV criterion A	

thermal curves :

curve 1 :

with ventilation in the heatsink (> 1m/s)

curve 2 :

working in normal conditions with a small ventilation in the cabinet

curve 3 :

according with IEC60947-4-2 in a closed cabinet without any ventilation.

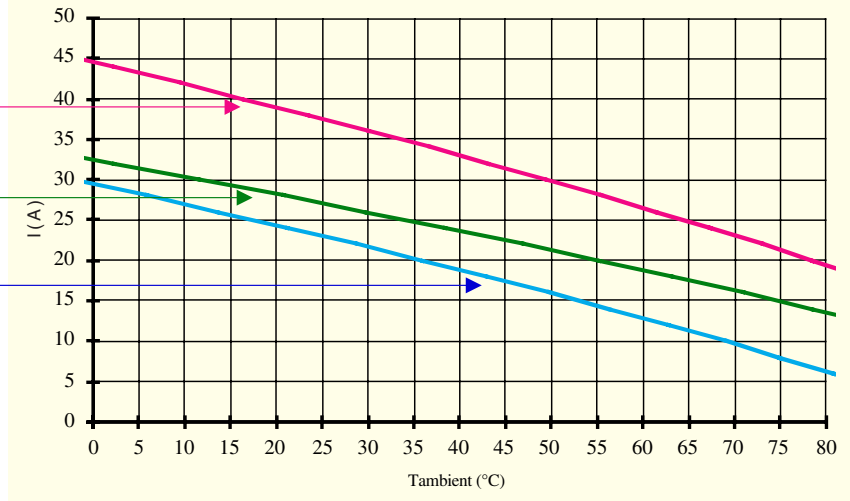
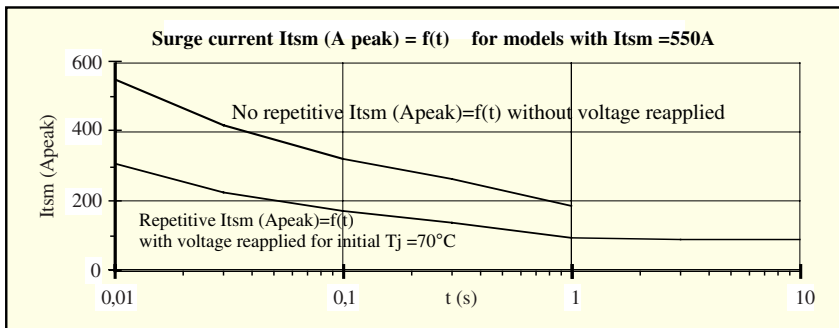

Fig.3 : Overload current curves



1 -No repetitive Itsm is given without voltage reapplied for the determination of the protection.





2 -Repetitive Itsm is given for inrush current with initial Tj = 70°C. The repetition of the surge current decrease the lifetime SSR's .





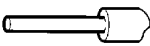

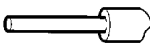
Cautions :

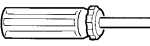
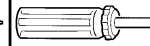
* Semiconductor relays don't provide any galvanic insulation between the load and the mains.

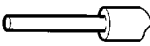
Proud to serve you

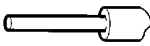

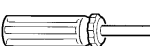
SVT						Wiring of the control circuit:	
NUMBER OF WIRES				SCREWDRIVER TYPE		MINIMUM TORQUE	
1		2					
SOLID (No ferrule)	FINE STRANDED (With ferrule)	SOLID (No ferrule)	FINE STRANDED (With ferrule)				
						N.m	
0,75 ... 2,5 mm ²	0,75 ... 2,5 mm ²	0,75 ... 2,5 mm ²	0,75 ... 2,5 mm ²	0,8 x 5,5 mm	POZIDRIV 2	1,2	

SVT						Wiring of the power circuit:	
NUMBER OF WIRES				SCREWDRIVER TYPE		MINIMUM TORQUE	
1		2					
SOLID (No ferrule)	FINE STRANDED (With ferrule)	SOLID (No ferrule)	FINE STRANDED (With ferrule)				
						N.m	
1,5 ... 10 mm ²	1,5 ... 6 mm ²	1,5 ... 10 mm ²	1,5 ... 6 mm ²	0,8 x 5,5 mm	POZIDRIV 2	1,8	

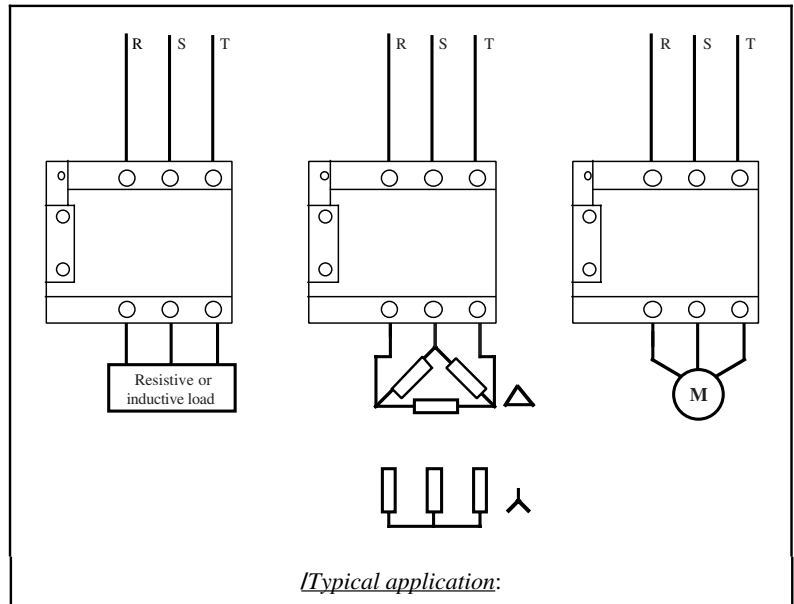
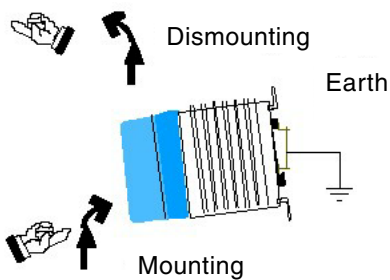

X-ON Electronics

Largest Supplier of Electrical and Electronic Components

Click to view similar products for [Celduc](#) manufacturer:

Other Similar products are found below :

[SIL465000](#) [D31C2100](#) [SO842074](#) [SKL20120](#) [WF311100](#) [WF108110](#) [SO445420](#) [SO865070](#) [SF541310](#) [SG464120](#) [1K460000](#) [SOM040200](#)
[SPD03505](#) [WF151200](#) [SO941460](#) [SO942460](#) [SOB863860](#) [SO863070](#) [SKL20240](#) [2YB20051](#) [SOM40100](#) [SC864110](#) [STA07220](#) [SO865970](#)
[PTI40020](#) [SCQ842060](#) [SUL963460](#) [SKA20420](#) [PLA13730](#) [PTPA0230](#) [SCF42324](#) [SF546310](#) [SP752120](#) [D32A3100](#) [SOB965660](#)
[ESD05000](#) [SO963460](#) [SKA20421](#) [SA963460](#) [SKA20460](#) [SKD10306](#) [SKA20441](#) [SOD865180](#) [SKA20440](#) [SLD03205](#) [PSL40010](#)
[SLD03210](#) [SO867070](#) [PSA60010](#) [SO965460](#)