

FLEXPOINT® Laser Diode Module Purple/Blue 405/450/488 nm

Descripton

FLEXPOINT® laser diode modules are available at blue and purple wavelengths (i.e., laser diodes at 405 nm, 450 nm, and 488 nm respectively). The maximum output power at 405 nm is 150 mW; at 450 nm it is 70 mW and 40 mW at 488 nm.

An aspheric lens is used as optic, allowing the laser beam to be either focused or collimated. Line lasers are also available. All drive electronics are already integrated into the housing.

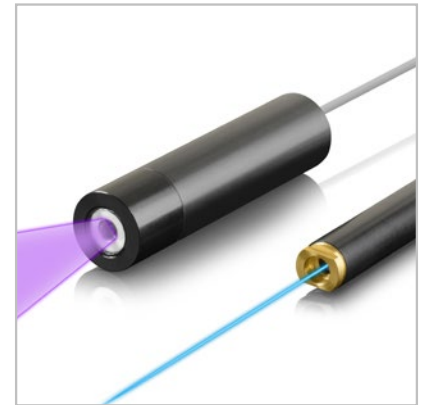

Features

- Circular or elliptical beam profile, line optics
- Output power up to 150 mW
- Optional digital modulation
- Optional power adjustment via potentiometer or third wire
- Choice of small or ruggedized housing

Applications

- Optical data storage
- Fluorescence excitation
- Spectroscopy
- Optical measuring systems
- Bio-medical applications
- Particle counting

Standard (small) Housing

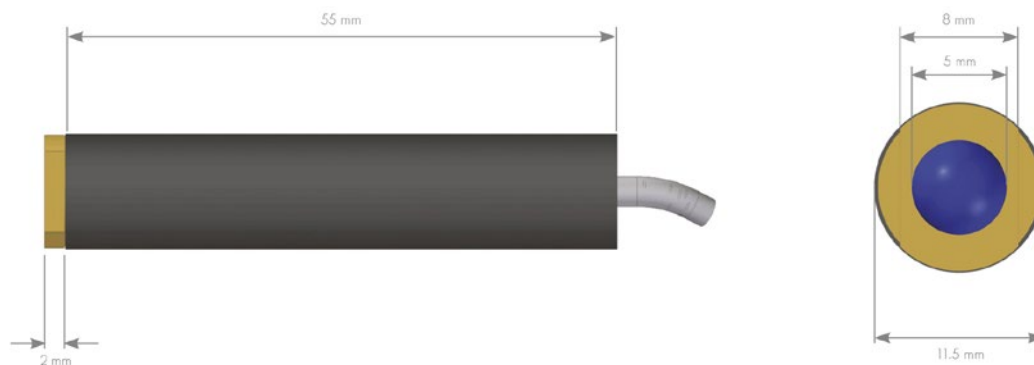

Ruggedized Housing:

Dot Lasers

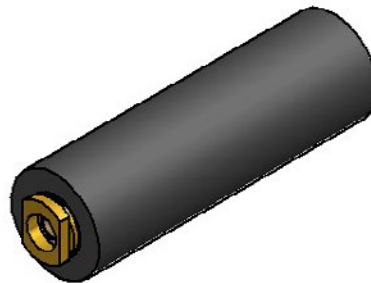
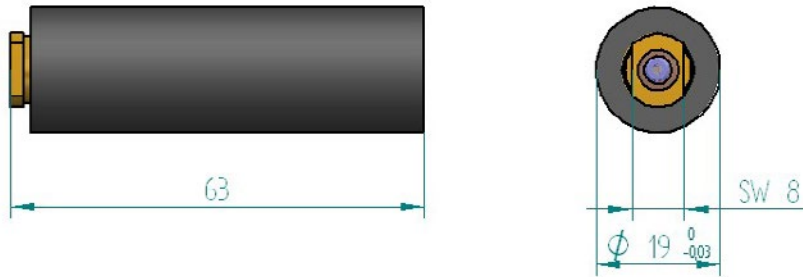

Line Lasers

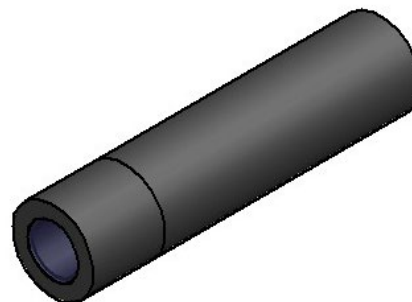
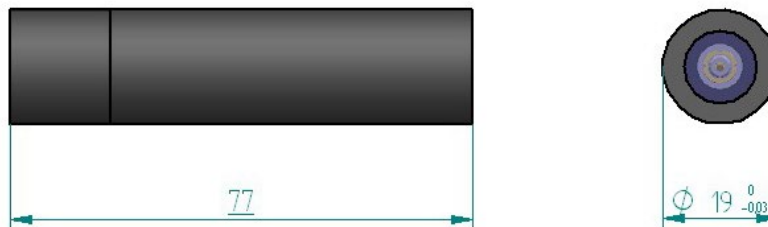

Specifications

Wavelength	405 nm	450 nm	488 nm
Output power	up to 150 mW	up to 70 mW	up to 40 mW
Power stability	< 5% after 5 – 10 minutes warm-up		
Beam profile	circular or elliptical (lower power with circular beam)		
Beam diameter at exit	circular: 4.5 mm elliptical: 3 mm x 1.5 mm		
Beam divergence	~ 0,6 mrad		
Fan angle (for line laser)	5 – 100° (factory set)		
Pointing stability	< 0.2 mrad / °C		
Focussing options	collimated / adjustable focus / focus preset		
Focussing range	50 mm to collimation (shorter focussing range on request)		
Input voltage	10 – 30 VDC, reverse voltage protection		
Power consumption	approx. 50 mA – 250 mA (depending on laser diode)		
Operating temperature range	-10 °C to +50 °C		
Housing	aluminium, potential free, black anodized		
Dimensions	standard: 57 mm length, 11.5 +0/-0.03 mm diameter ruggedized: 63 mm length, 19.0 +0/-0.03 mm diameter 77 mm length for line lasers		
Cable length	2 m		
Options	digital modulation (up to 10 kHz) output power adjustment via potentiometer or third wire line optics SMA fiber connector (fiber diameter > 100 µm)		
Accessories	mount, power supply, laser safety eyewear		

Ordering Code FLEXPOINT® 405/450 nm Dot Laser

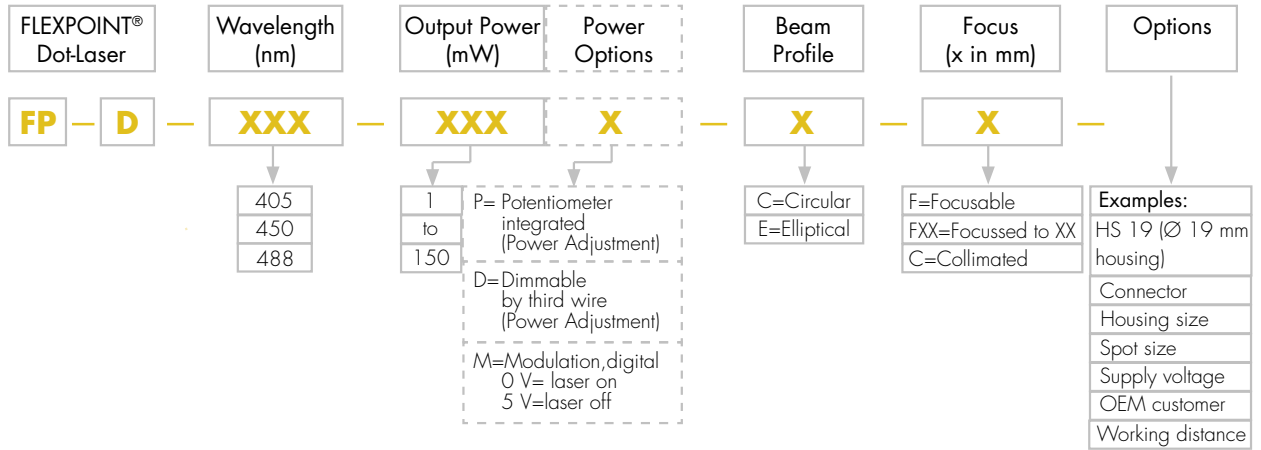

Ordering Code FLEXPOINT® 405/450 nm Line Lasers

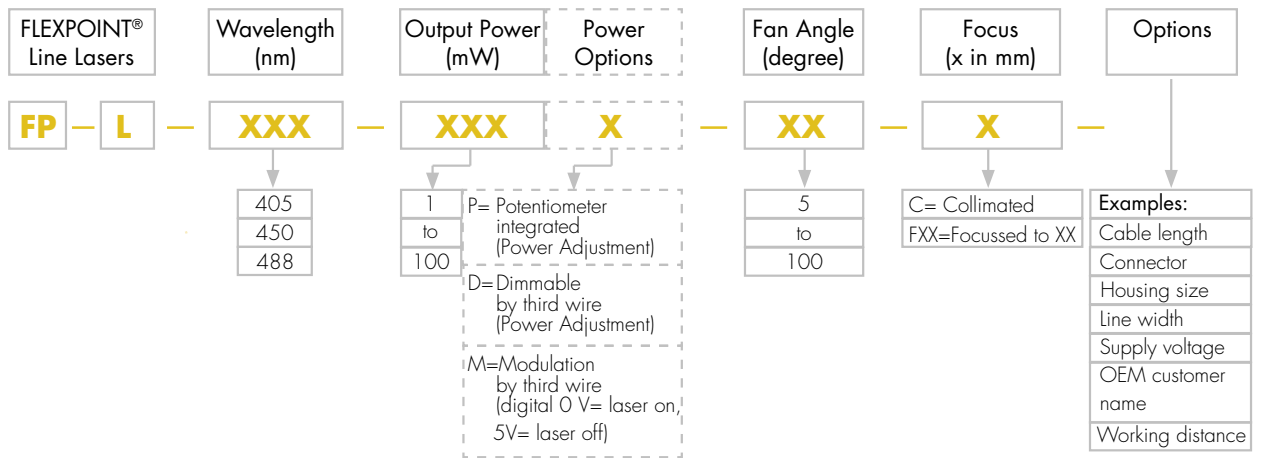

Standard Modules

FP-D-405-1-C-F	405 nm	1 mW	circular beam
FP-D-405-10-C-F	405 nm	10 mW	circular beam
FP-D-405-20-E-F	405 nm	20 mW	elliptical beam
FP-D-405-50-C-F	405 nm	50 mW	circular beam
FP-D-405-100-E-F	405 nm	100 mW	elliptical beam
FP-D-405-150-E-F	405 nm	150 mW	elliptical beam
FP-D-450-1-C-F	450 nm	1 mW	circular beam
FP-D-450-10-C-F	450 nm	10 mW	circular beam
FP-D-450-40-C-F	450 nm	40 mW	circular beam
FP-D-450-70-E-F	450 nm	70 mW	elliptical beam
FP-D-488-1-C-F	488 nm	1 mW	circular beam
FP-D-488-10-C-F	488 nm	10 mW	circular beam
FP-D-488-20-C-F	488 nm	20 mW	circular beam
FP-D-488-40-E-F	488 nm	40 mW	elliptical beam

*all specifications subject to change without notice

X-ON Electronics

Largest Supplier of Electrical and Electronic Components

Click to view similar products for [Distance Sensor Modules](#) category:

Click to view products by [Laser Components](#) manufacturer:

Other Similar products are found below :

[114992561](#) [114991133](#) [TF03-100 420ma](#) [TF03-180 420ma](#) [ILM12F-DOE-520-7-289-F](#) [LC-LMD-635-03-01-A](#) [LC-LMD-650-01-03-A](#) [LC-LMD-650-02-01-A](#) [LC-LMD-650-02-03-A](#) [LC-LMD-650-03-01-A](#) [LC-LMD-650-05-05-A](#) [LC-LMD-780-01-01-A](#) [LC-LMD-780-01-03-A](#) [LC-LMD-850-01-01-A](#) [LC-LMD-850-01-03-A](#) [FP-D-520-5-C-F](#) [FP-D-650-1-C-F](#) [FP-HD-L-635-7-30-F](#) [FP-L-520-10-50-C](#) [FP-D-405-16-E-F](#) [FP-D-635-13-E-F](#) [FP-D-635-17-C-F](#) [FP-D-635-3-E-F](#) [FP-D-635-40-C-F](#) [FP-D-635-7-E-F](#) [FP-D-650-20-C-F-24](#) [FP-D-650-25-E-F](#) [FP-D-650-3-E-F](#) [FP-D-660-40-C-F](#) [FP-D-670-1-C-F](#) [FP-D-670-5-C-F](#) [FP-D-785-50-C-F](#) [FP-D-850-1-C-F](#) [FP-D-850-5-E-F](#) [FP-D-905-7-E-F](#) [FP-L-405-15-50-C](#) [FP-L-635-1-50-C](#) [FP-L-635-5-50-C](#) [FP-L-650-1-50-C](#) [FP-L-850-3-50-C](#) [FP-L-905-5-50-C](#) [ILM12F-DOE-520-7-259-F](#) [FP-MV18-ST-660-20-30-F-STD](#) [ILM12F-D-635-1-C-F](#) [ILM12F-DOE-635-7-247-F](#) [ILM12F-L-520-7-58-F](#) [ILM12F-L-635-7-58-F](#) [LC-LMD-635-02-03-A](#) [LC-LMD-635-03-03-A](#) [LC-LMD-650-01-01-A](#)