

DISPLAY Elektronik GmbH

DATA SHEET

LCD MODULE

DEM 16213 SYH

Product Specification

Version : 1.1.1

09/Apr/2009

GENERAL SPECIFICATION

MODULE NO. :

DEM 16213 SYH

CUSTOMER P/N

| Version No. | Change Description | Date |
|-------------|--------------------|------------|
| 0 | ORIGINAL VERSION | 08.03.2001 |
| 1 | PCB CHANGED | 04.04.2003 |
| 1.1.0 | CHANGE IC | 04.01.2008 |
| 1.1.1 | IMPROVE DRAWING | 09.04.2009 |
| | | |
| | | |
| | | |
| | | |
| | | |
| | | |
| | | |
| | | |

PREPARED BY: HCL

DATE: 09.04.2009

APPROVED BY: MH

DATE: 09.04.2009

CONTENTS

1.FUNCTIONS & FEATURES2

2. MECHANICAL SPECIFICATIONS.....2

3. EXTERNAL DIMENSIONS.....3

4. BLOCK DIAGRAM.....4

5. PIN ASSIGNMENT.....4

6.1 PCB DRAWING AND DESCRIPTION5

6.2 EXAMPLE APPLICATION5

7. MAXIMUM ABSOLUTE POWER RATINGS5

8. ELECTRICAL CHARACTERISTICS6

9. DISPLAY DATA RAM (DDRAM)7

10. INSTRUCTION TABLE8

11. INITIALIZING BY INSTRUCTION9

12. CHARACTER GENERATOR ROM (ST7066-0A)..... 11

13. LCD MODULES HANDLING PRECAUTIONS..... 12

14. OTHERS..... 12

1. FUNCTIONS & FEATURES

| MODULE NAME | LCD Type |
|--------------------|---|
| DEM 16213 SYH | STN Yellow-Green Reflective Positive Mode |

- Viewing Direction : 6 o'clock
- Driving Scheme : 1/16 Duty Cycle, 1/5 Bias
- Power Supply Voltage : 5.0 Volt (typ.)
- V_{LCD} Adjustable For Best Contrast : 4.5 Volt (typ.)
- Display Format : 16 x 2 Characters
- Internal Memory : CGROM (13,200 bits)
: CGRAM (64 x 8 bits)
: DDRAM (80 x 8 bits)
- Interface : Easy Interface with a 4-bit or 8-bit MPU
- Operating Temperature : -20°C to +70°C
- Storage Temperature : -30°C to +80°C

2. MECHANICAL SPECIFICATIONS

- Module Size : 80.00 x 36.00 x 9.00 mm
- Character Pitch : 3.65 x 5.05 mm
- Character Size : 2.95 x 4.35 mm
- Character Font : 5 x 8 dots
- Dot Size : 0.55 x 0.50 mm
- Dot Pitch : 0.60 x 0.55 mm

3. EXTERNAL DIMENSIONS

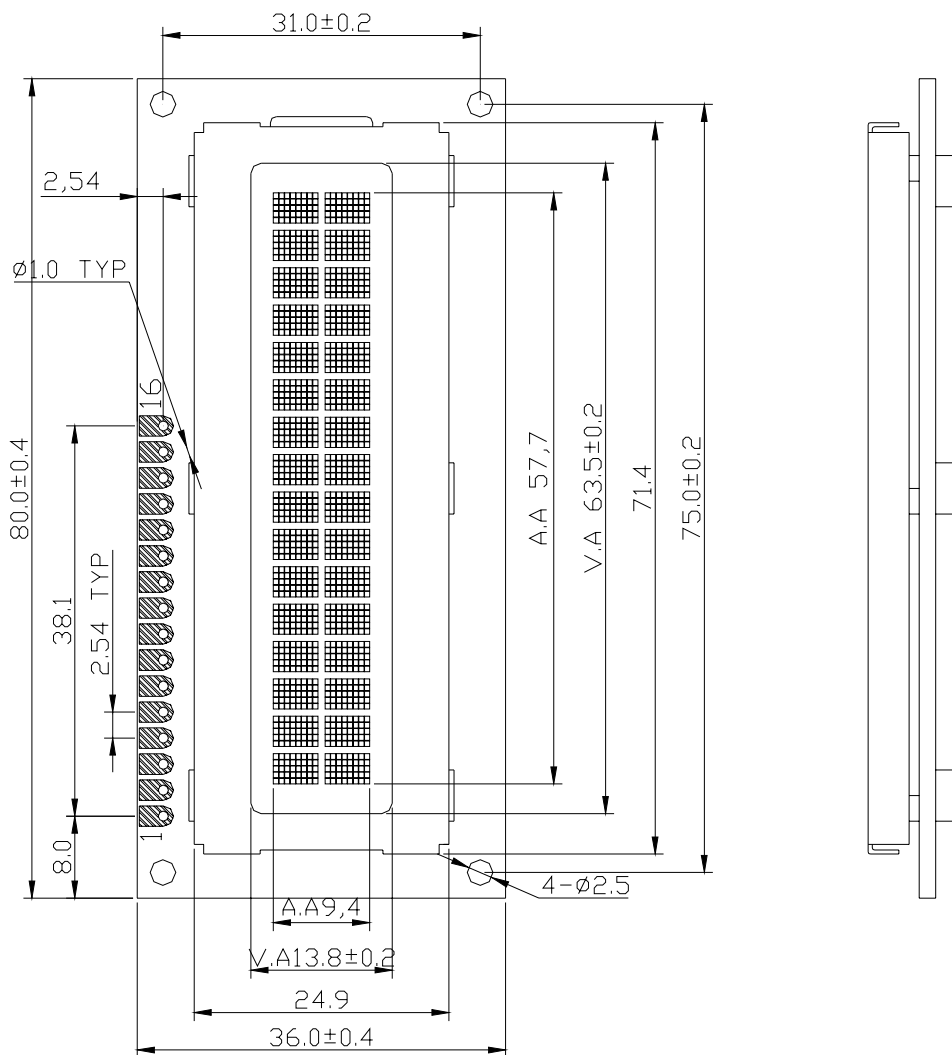
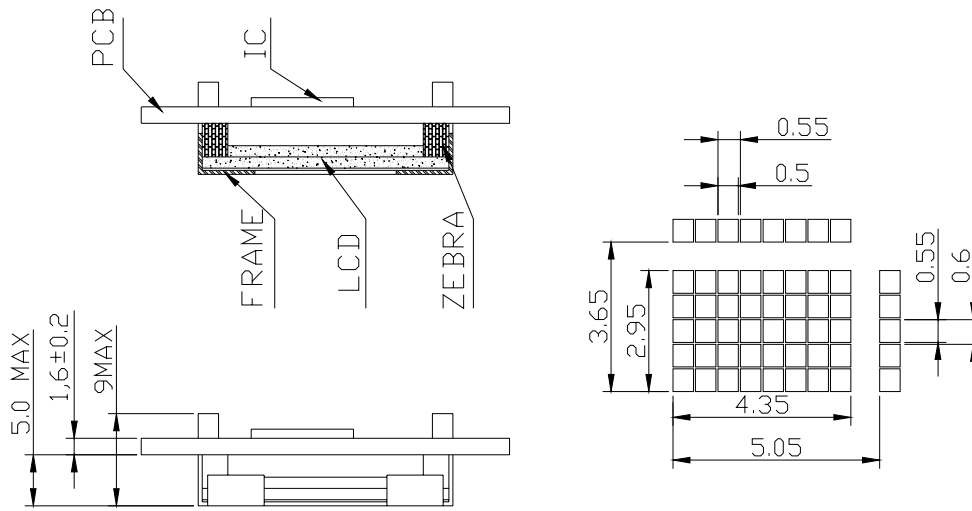

Remarks:
 1, Unmarked tolerance is ±0.3,
 2, The material comply with RoHS.

4. BLOCK DIAGRAM

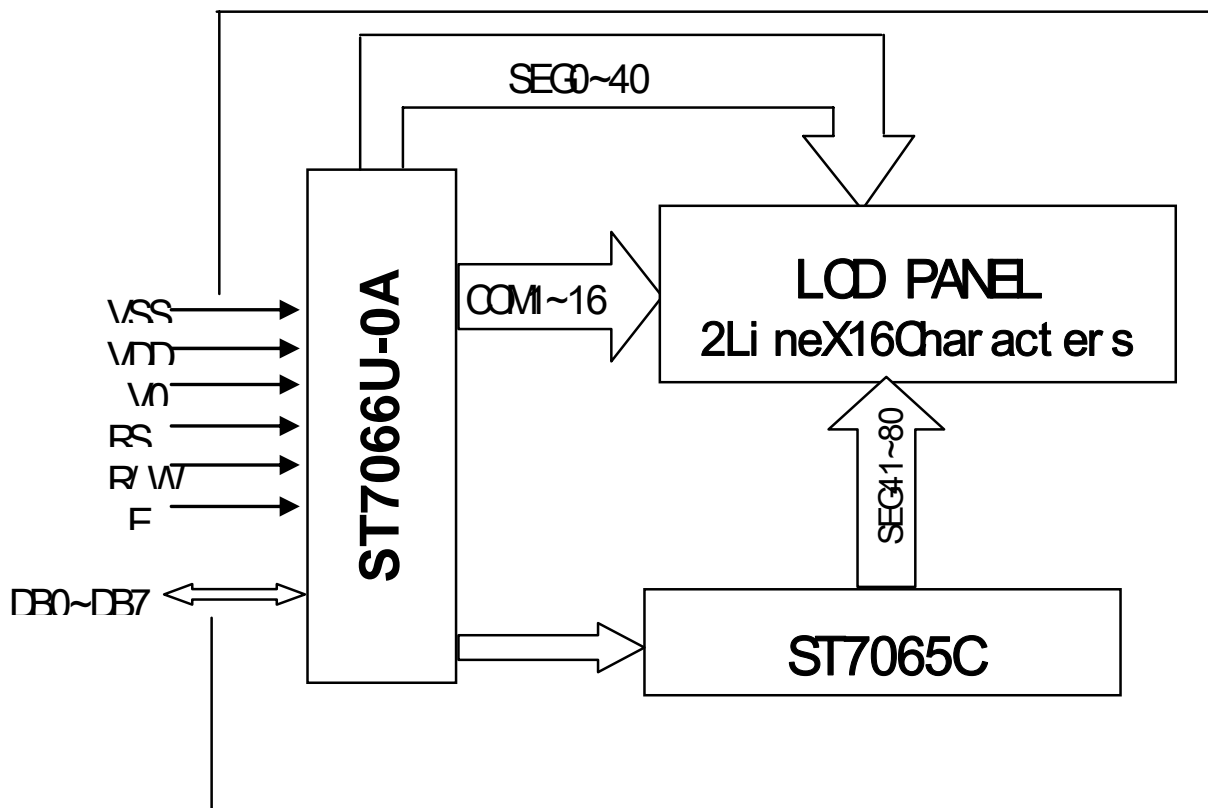

5. PIN ASSIGNMENT

| Pin No. | Symbol | Function |
|---------|--------|--|
| 1 | VSS | Ground terminal of module. |
| 2 | VDD | Supply terminal of module 5.0V. |
| 3 | V0 | Power Supply for liquid crystal drive. |
| 4 | RS | Register select RS = 0...Instruction register RS = 1...Data register |
| 5 | R/W | Read /Write R/W = 1...Read R/W = 0...Write |
| 6 | E | Enable |
| 7 | DB0 | Bi-directional data bus, data transfer is performed once, thru DB0 to DB7, in the case of interface data. Length is 8-bits; and twice, thru DB4 to DB7 in the case of interface data length is 4-bits. Upper four bits first then lower four bits. |
| 8 | DB1 | |
| 9 | DB2 | |
| 10 | DB3 | |
| 11 | DB4 | |
| 12 | DB5 | |
| 13 | DB6 | |
| 14 | DB7 | |
| 15 | NC | No Connect |
| 16 | NC | |

6.1 PCB DRAWING AND DESCRIPTION

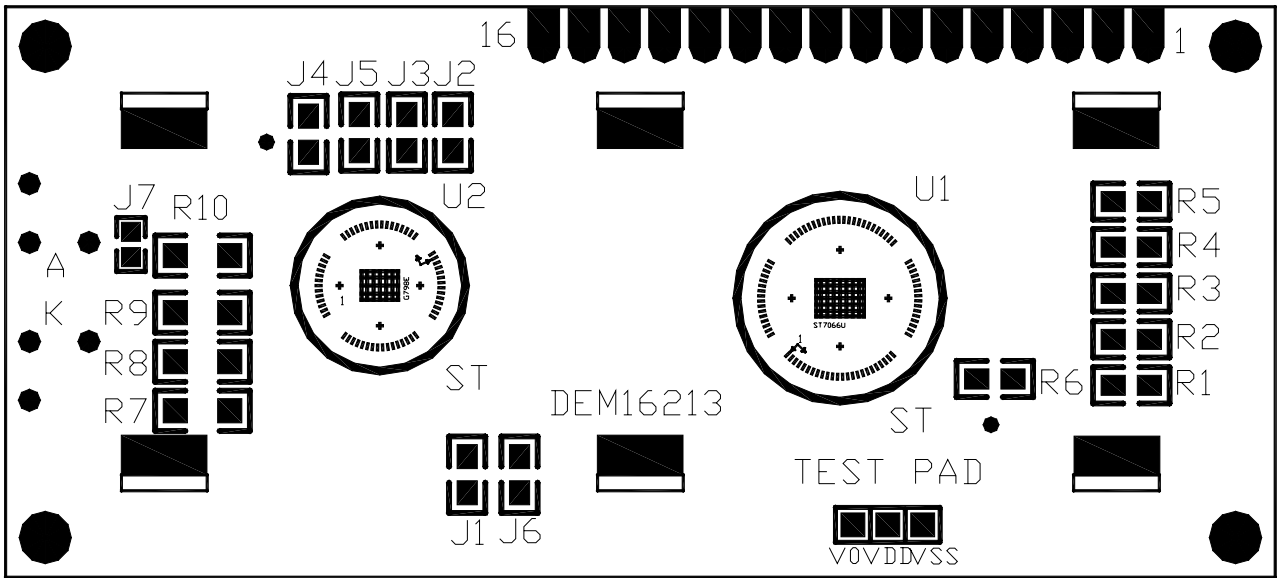

DESCRIPTION:

6-1-1. The polarity of the pin 15 and the pin 16:

Note: In application module, J2=J3=J4=J5=open.

6-1-2. The J1 is metal-bezel GND to module GND and J6 is mounting holes GND to module GND.

Note: In application module, J1= J6=0 ohm.

6.2 Example application

6-2-1. The metal-bezel is on ground as following.

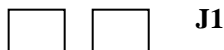

6-2-2. The mounting hole is on ground as following.



7. MAXIMUM ABSOLUTE POWER RATINGS

| Item | Symbol | Standard Value | Unit |
|-------------------------|------------------|--|------|
| Power supply voltage(1) | V _{DD} | -0.3~+7.0 | V |
| Power supply voltage(2) | V _{LCD} | V _{DD} -10.0~V _{DD} +0.3 | V |
| Input voltage | V _{IN} | -0.3~V _{DD} +0.3 | V |
| Operating temperature | T _{opr} | -20~+70 | °C |
| Storage temperature | T _{stg} | -30~+80 | °C |

8. ELECTRICAL CHARACTERISTICS

8-1 DC Characteristics ($V_{DD}=5V, T_a=25^{\circ}C$)

| Item | Symbol | Standard Value | | | Test Condition | Unit |
|---------------------|-----------|----------------|-----|-----|--|------|
| | | Min | Typ | Max | | |
| Operating Voltage | V_{DD} | 4.7 | 5.0 | 5.3 | ----- | V |
| Supply Current | I_{DD1} | ---- | TBD | 1.0 | Ceramic oscillation $f_{osc}=250kHz$ | mA |
| | I_{DD2} | ---- | TBD | 0.6 | Resistor oscillation external clock operation $f_{osc}=270kHz$ | |
| LCD Driving Voltage | V_{LCD} | 4.2 | 4.5 | 4.8 | $V_{DD}-V_0$ | V |

8-2 AC Characteristics

| Symbol | Characteristics | Test Condition | Min. | Typ. | Max. | Unit |
|--|-----------------------|-----------------|------|------|------|------|
| <i>Write Mode (Writing data from MPU to ST7066U)</i> | | | | | | |
| T_C | Enable Cycle Time | Pin E | 1200 | - | - | ns |
| T_{PW} | Enable Pulse Width | Pin E | 140 | - | - | ns |
| T_R, T_F | Enable Rise/Fall Time | Pin E | - | - | 25 | ns |
| T_{AS} | Address Setup Time | Pins: RS, RW, E | 0 | - | - | ns |
| T_{AH} | Address Hold Time | Pins: RS, RW, E | 10 | - | - | ns |
| T_{DSW} | Data Setup Time | Pins: DB0 - DB7 | 40 | - | - | ns |
| T_H | Data Hold Time | Pins: DB0 - DB7 | 10 | - | - | ns |
| <i>Read Mode (Reading Data from ST7066U to MPU)</i> | | | | | | |
| T_C | Enable Cycle Time | Pin E | 1200 | - | - | ns |
| T_{PW} | Enable Pulse Width | Pin E | 140 | - | - | ns |
| T_R, T_F | Enable Rise/Fall Time | Pin E | - | - | 25 | ns |
| T_{AS} | Address Setup Time | Pins: RS, RW, E | 0 | - | - | ns |
| T_{AH} | Address Hold Time | Pins: RS, RW, E | 10 | - | - | ns |
| T_{DDR} | Data Setup Time | Pins: DB0 - DB7 | - | - | 100 | ns |
| T_H | Data Hold Time | Pins: DB0 - DB7 | 10 | - | - | ns |
| <i>Interface Mode with LCD Driver(ST7065)</i> | | | | | | |
| T_{CWH} | Clock Pulse with High | Pins: CL1, CL2 | 800 | - | - | ns |
| T_{CWL} | Clock Pulse with Low | Pins: CL1, CL2 | 800 | - | - | ns |
| T_{CST} | Clock Setup Time | Pins: CL1, CL2 | 500 | - | - | ns |
| T_{SU} | Data Setup Time | Pin: D | 300 | - | - | ns |
| T_{DH} | Data Hold Time | Pin: D | 300 | - | - | ns |
| T_{DM} | M Delay Time | Pin: M | 0 | - | 2000 | ns |

● Writing data from MPU to ST7066U

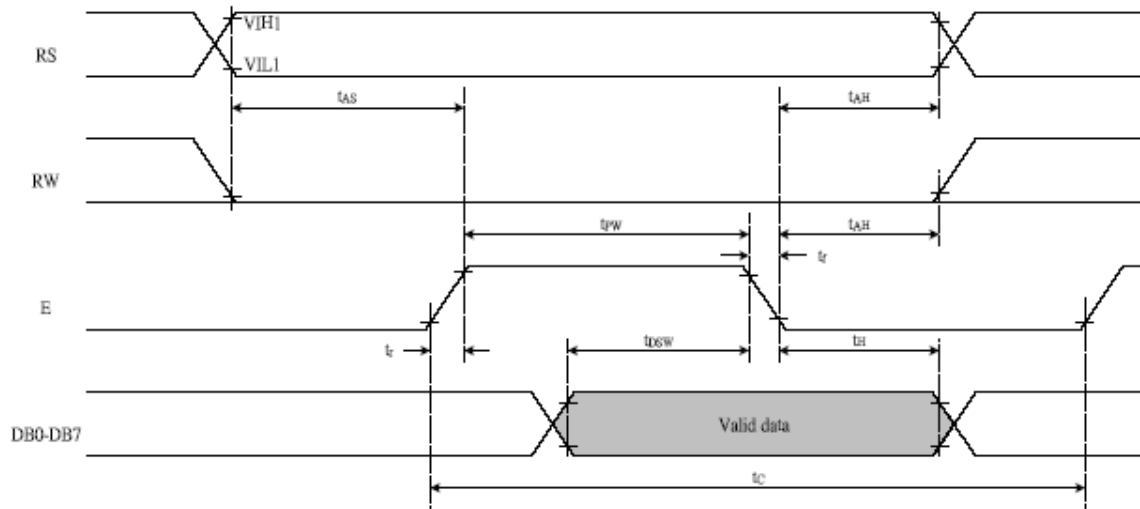

● Reading data from ST7066U to MPU

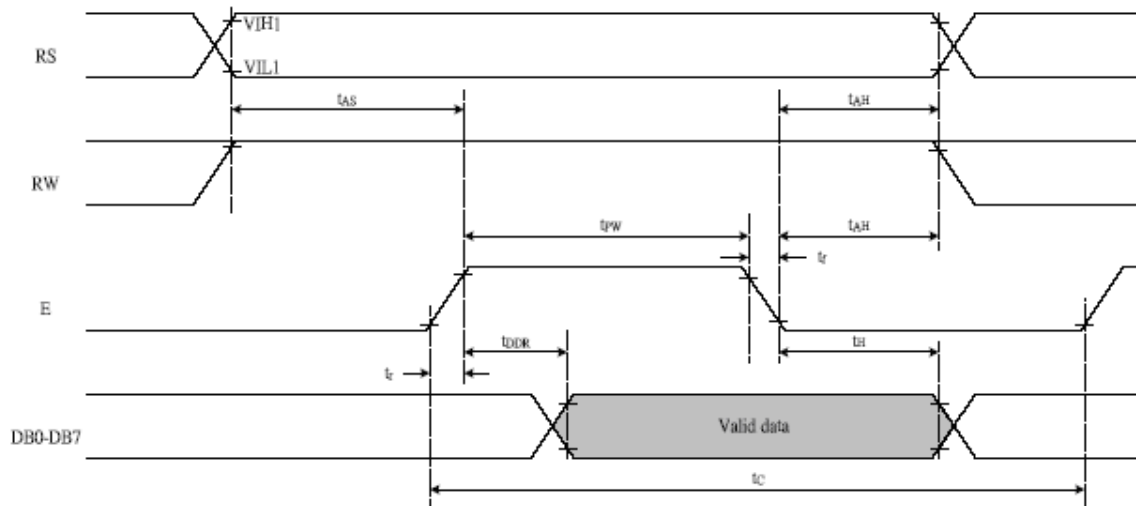

9. DISPLAY DATA RAM (DDRAM)

| | | | | | | | | | | | | | | | | |
|---------------|----|----|----|----|----|----|----|----|----|----|----|----|----|----|----|----|
| Display | 1 | 2 | 3 | 4 | 5 | 6 | 7 | 8 | 9 | 10 | 11 | 12 | 13 | 14 | 15 | 16 |
| Position | 00 | 01 | 02 | 03 | 04 | 05 | 06 | 07 | 08 | 09 | 0A | 0B | 0C | 0D | 0E | 0F |
| DDRAM Address | 40 | 41 | 42 | 43 | 44 | 45 | 46 | 47 | 48 | 49 | 4A | 4B | 4C | 4D | 4E | 4F |

| | | | | | | | | | | | | | | | | |
|----------------|----|----|----|----|----|----|----|----|----|----|----|----|----|----|----|----|
| For Shift Left | 01 | 02 | 03 | 04 | 05 | 06 | 07 | 08 | 09 | 0A | 0B | 0C | 0D | 0E | 0F | 10 |
| | 41 | 42 | 43 | 44 | 45 | 46 | 47 | 48 | 49 | 4A | 4B | 4C | 4D | 4E | 4F | 50 |

| | | | | | | | | | | | | | | | | |
|-----------------|----|----|----|----|----|----|----|----|----|----|----|----|----|----|----|----|
| For Shift Right | 27 | 00 | 01 | 02 | 03 | 04 | 05 | 06 | 07 | 08 | 09 | 0A | 0B | 0C | 0D | 0E |
| | 67 | 40 | 41 | 42 | 43 | 44 | 45 | 46 | 47 | 48 | 49 | 4A | 4B | 4C | 4D | 4E |

10. INSTRUCTION TABLE

| Instruction | Instruction Code | | | | | | | | | | Description | Description Time (270KHz) | |
|----------------------------|------------------|-----|-----|-----|-----|-----|-----|-----|-----|-----|-------------|--|---------|
| | RS | R/W | DB7 | DB6 | DB5 | DB4 | DB3 | DB2 | DB1 | DB0 | | | |
| Clear Display | 0 | 0 | 0 | 0 | 0 | 0 | 0 | 0 | 0 | 0 | 1 | Write "20H" to DDRAM. and set DDRAM address to "00H" from AC | 1.52 ms |
| Return Home | 0 | 0 | 0 | 0 | 0 | 0 | 0 | 0 | 0 | 1 | x | Set DDRAM address to "00H" from AC and return cursor to its original position if shifted. The contents of DDRAM are not changed. | 1.52 ms |
| Entry Mode Set | 0 | 0 | 0 | 0 | 0 | 0 | 0 | 0 | 1 | I/D | S | Sets cursor move direction and specifies display shift. These operations are performed during data write and read. | 37 us |
| Display ON/OFF | 0 | 0 | 0 | 0 | 0 | 0 | 0 | 1 | D | C | B | D=1:entire display on C=1:cursor on B=1:cursor position on | 37 us |
| Cursor or Display Shift | 0 | 0 | 0 | 0 | 0 | 0 | 1 | S/C | R/L | x | x | Set cursor moving and display shift control bit, and the direction, without changing DDRAM data. | 37 us |
| Function Set | 0 | 0 | 0 | 0 | 0 | 1 | DL | N | F | x | x | DL:interface data is 8/4 bits N:number of line is 2/1 F.font size is 5x11/5x8 | 37 us |
| Set CGRAM address | 0 | 0 | 0 | 1 | AC5 | AC4 | AC3 | AC2 | AC1 | AC0 | | Set CGRAM address in address counter | 37 us |
| Set DDRAM address | 0 | 0 | 1 | AC6 | AC5 | AC4 | AC3 | AC2 | AC1 | AC0 | | Set DDRAM address in address counter | 37 us |
| Read Busy flag and address | 0 | 1 | BF | AC6 | AC5 | AC4 | AC3 | AC2 | AC1 | AC0 | | Whether during internal operation or not can be known by reading BF. The contents of address counter can also be read. | 0 us |
| Write data to RAM | 1 | 0 | D7 | D6 | D5 | D4 | D3 | D2 | D1 | D0 | | Write data into internal RAM (DDRAM/CGRAM) | 37 us |
| Read data from RAM | 1 | 1 | D7 | D6 | D5 | D4 | D3 | D2 | D1 | D0 | | Read data from internal RAM (DDRAM/CGRAM) | 37 us |

Note:

Be sure the ST7066U is not in the busy state (BF = 0) before sending an instruction from the MPU to the ST7066U. If an instruction is sent without checking the busy flag, the time between the first instruction and next instruction will take much longer than the instruction time itself. Refer to Instruction Table for the list of each instruction execution time.

11. INITIALIZING BY INSTRUCTION

11-1. 8-bit interface mode (fosc=270 kHz)

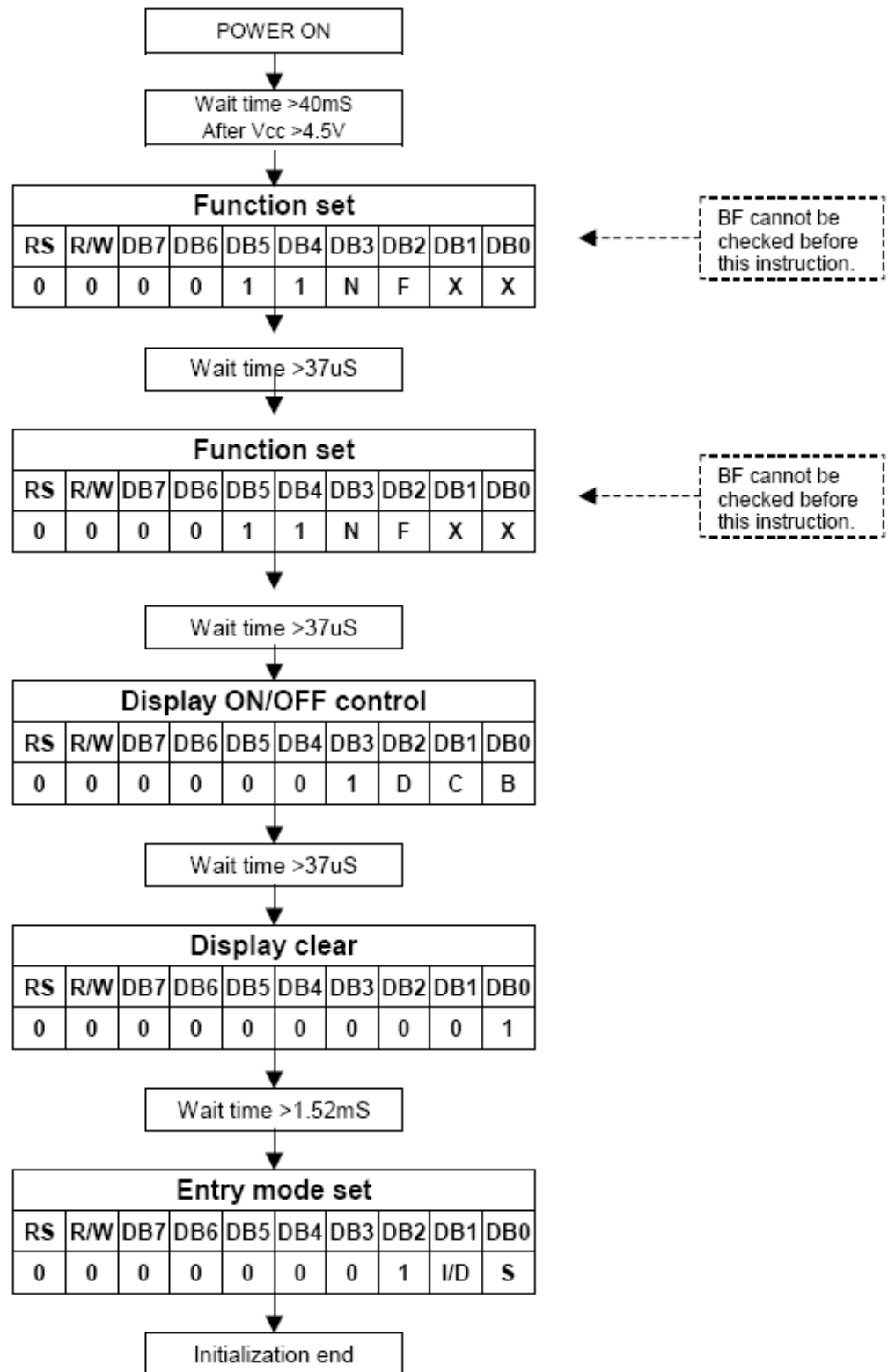

11-2. 4-bit interface mode

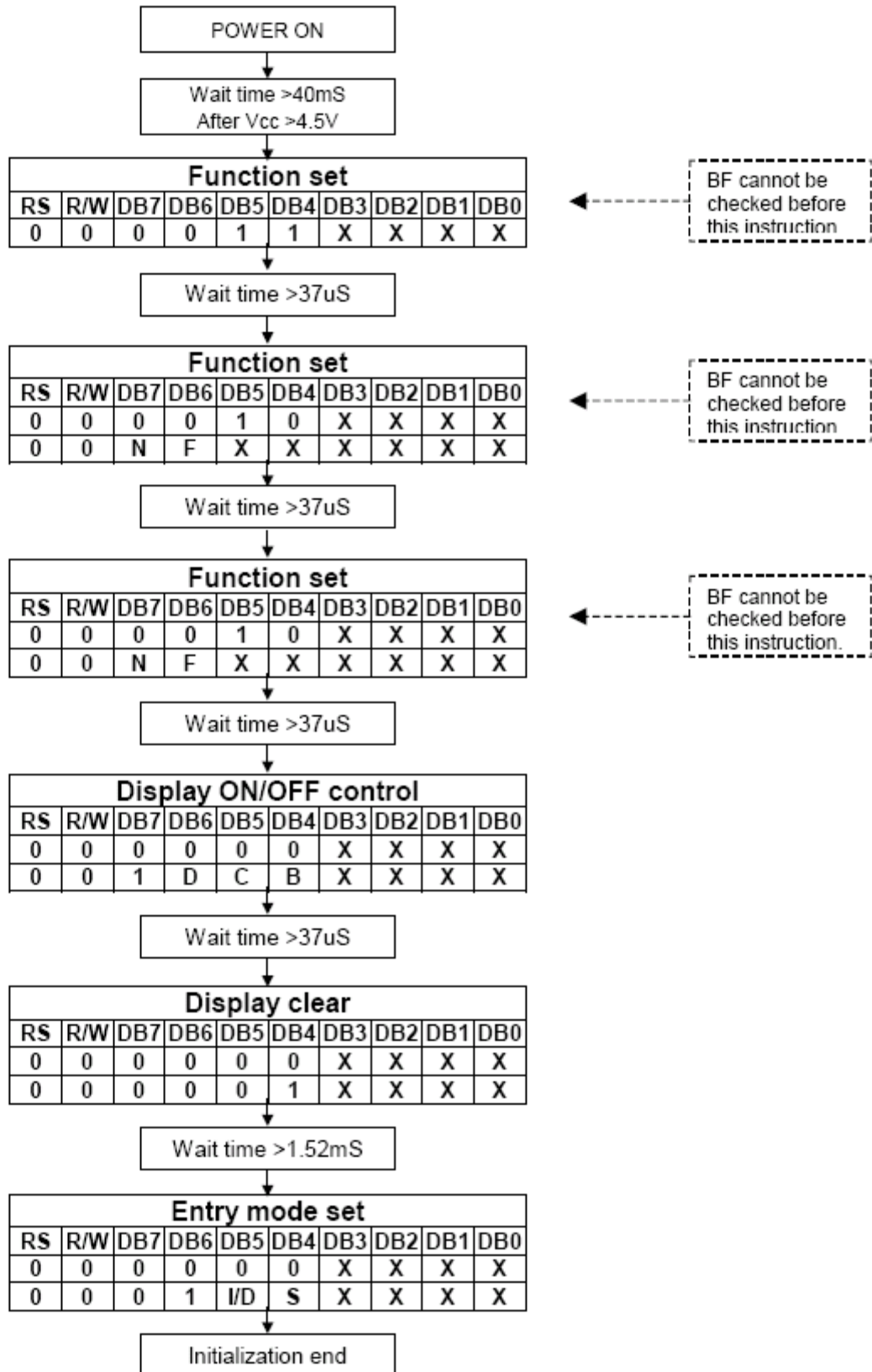

12. CHARACTER GENERATOR ROM (ST7066-0A)

NO.7066-0A

| b7-b4 b3-b0 | 0000 | 0001 | 0010 | 0011 | 0100 | 0101 | 0110 | 0111 | 1000 | 1001 | 1010 | 1011 | 1100 | 1101 | 1110 | 1111 |
|----------------|------------------|------|------|------|------|------|------|------|------|------|------|------|------|------|------|------|
| 0000 | CG RAM (1) | | | 0 | 1 | 2 | 3 | 4 | | | | — | 5 | 6 | 7 | 8 |
| 0001 | (2) | | ! | 1 | A | a | 9 | | | | 0 | 7 | 8 | 9 | a | q |
| 0010 | (3) | | " | 2 | B | b | r | | | | 1 | 4 | 5 | 6 | p | 0 |
| 0011 | (4) | | # | 3 | C | c | s | | | | 2 | 3 | 4 | 5 | e | 0 |
| 0100 | (5) | | \$ | 4 | D | d | t | | | | 3 | 4 | 5 | 6 | p | 0 |
| 0101 | (6) | | % | 5 | E | e | u | | | | 4 | 5 | 6 | 7 | 8 | 0 |
| 0110 | (7) | | & | 6 | F | f | v | | | | 5 | 6 | 7 | 8 | p | Σ |
| 0111 | (8) | | * | 7 | G | g | w | | | | 6 | 7 | 8 | 9 | g | π |
| 1000 | (1) | | < | 8 | H | h | x | | | | 7 | 8 | 9 | 0 | 1 | Σ |
| 1001 | (2) | | > | 9 | I | i | w | | | | 8 | 9 | 0 | 1 | 2 | y |
| 1010 | (3) | | * | : | J | j | z | | | | 9 | 0 | 1 | 2 | j | Σ |
| 1011 | (4) | | + | ; | K | k | < | | | | 0 | 1 | 2 | 3 | 0 | π |
| 1100 | (5) | | , | < | L | l | l | | | | 1 | 2 | 3 | 4 | 0 | π |
| 1101 | (6) | | — | = | M | m | > | | | | 2 | 3 | 4 | 5 | 1 | + |
| 1110 | (7) | | . | > | N | n | → | | | | 3 | 4 | 5 | 6 | π | |
| 1111 | (8) | | / | ? | O | o | ← | | | | 4 | 5 | 6 | 7 | 0 | ■ |

13. LCD MODULES HANDLING PRECAUTIONS

- Please remove the protection foil of polarizer before using.
- The display panel is made of glass. Do not subject it to a mechanical shock by dropping it from a high place, etc.
- If the display panel is damaged and the liquid crystal substance inside it leaks out, do not get any in your mouth. If the substance come into contact with your skin or clothes promptly wash it off using soap and water.
- Do not apply excessive force to the display surface or the adjoining areas since this may cause the color tone to vary.
- The polarizer covering the display surface of the LCD module is soft and easily scratched. Handle this polarize carefully.
- To prevent destruction of the elements by static electricity, be careful to maintain an optimum work environment.
 - Be sure to ground the body when handling the LCD module.
 - Tools required for assembly, such as soldering irons, must be properly grounded.
 - To reduce the amount of static electricity generated, do not conduct assembly and other work under dry conditions.
 - The LCD module is coated with a film to protect the display surface. Exercise care when peeling off this protective film since static electricity may be generated.
- Storage precautions
When storing the LCD modules, avoid exposure to direct sunlight or to the light of fluorescent lamps. Keep the modules in bags designed to prevent static electricity charging under low temperature / normal humidity conditions (avoid high temperature / high humidity and low temperatures below 0°C). Whenever possible, the LCD modules should be stored in the same conditions in which they were shipped from our company.

14. OTHERS

- Liquid crystals solidify at low temperature (below the storage temperature range) leading to defective orientation of liquid crystal or the generation of air bubbles (black or white). Air bubbles may also be generated if the module is subjected to a strong shock at a low temperature.
- If the LCD modules have been operating for a long time showing the same display patterns may remain on the screen as ghost images and a slight contrast irregularity may also appear. Abnormal operating status can be resumed to be normal condition by suspending use for some time. It should be noted that this phenomena does not adversely affect performance reliability.
- To minimize the performance degradation of the LCD modules resulting from caused by static electricity, etc. exercise care to avoid holding the following sections when handling the modules:
 - Exposed area of the printed circuit board
 - Terminal electrode sections.

X-ON Electronics

Largest Supplier of Electrical and Electronic Components

Click to view similar products for [TFT Displays & Accessories](#) category:

Click to view products by [Display Elektronik](#) manufacturer:

Other Similar products are found below :

[OAI-80038AA-2013-A](#) [HDA430T-3G1H](#) [EA CARREDIPTFT02](#) [NL6448BC20-21D](#) [NB7W-KBA04](#) [NB-ATT01](#) [NB5Q-ATT01](#) [NB5Q-KBA04](#) [NB-CN001](#) [NL12880BC20-05](#) [NL8060BC26-35C](#) [NL8060BC26-35F](#) [TCG104SVLQAPNN-AN20](#) [OAI-80038AA-2008-A](#) [315-U004B15300](#) [UMSH-8596MD-34T \(REV D\)](#) [98-0003-3490-8](#) [1044278](#) [1029309](#) [1060549](#) [DE 127-TU-30/7,5](#) [DE 128-TU-20/7,5](#) [EP-LK007TFTPCAP](#) [FR7.0A00](#) [RC2002A-TIG-CSX](#) [NL6448BC2021C](#) [TX17D01VM2EAB](#) [TX14D23VM5BAA](#)
[TCG121WXLRXVNNANX35](#) [EIC-LCD-1080P](#) [T272480C07VR01](#) [1060632](#) [TCG070WVLPAAANN-AN50](#) [TCG035QVLPDANN-GN50](#)
[1060630](#) [RFE430V-AIW-DNG](#) [T-55619GD065J-LW-ABN](#) [NHD-1.8-128160EF-SSXN-FT](#) [TCG104SVLPEANN-AN30](#) [NL6448BC33-70](#)
[NL192108BC18-06F](#) [NLB150XG02L-01](#) [NL6448BC20-30D](#) [NL10276BC16-06](#) [NL192108AC10-01D](#) [NL6448AC18-08F](#) [NL6448BC20-30F](#)
[NL12880BC20-05BD](#) [NL12880BC20-05D](#) [NL8060BC26-35BA](#)