

# IRF6797MPbF IRF6797MTRPbF

HEXFET® Power MOSFET plus Schottky Diode ②

Typical values (unless otherwise specified)

| V <sub>DS</sub>     |  | V <sub>GS</sub> |                  | R <sub>DS(on)</sub> |                  |
|---------------------|--|-----------------|------------------|---------------------|------------------|
| 25V max             |  | ±20V max        |                  | 1.1mΩ@ 10V          |                  |
| Q <sub>g tot</sub>  |  | Q <sub>gd</sub> | Q <sub>gs2</sub> | Q <sub>rr</sub>     | Q <sub>oss</sub> |
| 45nC                |  | 13nC            | 6.2nC            | 38nC                | 38nC             |
| V <sub>gs(th)</sub> |  |                 |                  |                     |                  |
| 1.8V                |  |                 |                  |                     |                  |

- RoHs Compliant Containing No Lead and Bromide ①
- Integrated Monolithic Schottky Diode
- Low Profile (<0.7 mm)
- Dual Sided Cooling Compatible ①
- Ultra Low Package Inductance
- Optimized for High Frequency Switching ①
- Ideal for CPU Core DC-DC Converters
- Optimized for Sync. FET socket of Sync. Buck Converter①
- Low Conduction and Switching Losses
- Compatible with existing Surface Mount Techniques ①
- 100% Rg tested

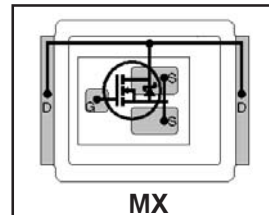

Applicable DirectFET Outline and Substrate Outline (see p.7,8 for details)①

|    |    |    |  |    |           |    |    |  |  |
|----|----|----|--|----|-----------|----|----|--|--|
| SQ | SX | ST |  | MQ | <b>MX</b> | MT | MP |  |  |
|----|----|----|--|----|-----------|----|----|--|--|

### Description

The IRF6797MPbF combines the latest HEXFET® Power MOSFET Silicon technology with the advanced DirectFET™ packaging to achieve the lowest on-state resistance in a package that has the footprint of a SO-8 and only 0.7 mm profile. The DirectFET package is compatible with existing layout geometries used in power applications, PCB assembly equipment and vapor phase, infra-red or convection soldering techniques. Application note AN-1035 is followed regarding the manufacturing methods and processes. The DirectFET package allows dual sided cooling to maximize thermal transfer in power systems, improving previous best thermal resistance by 80%.

The IRF6797MPbF balances industry leading on-state resistance while minimizing gate charge along with ultra low package inductance to reduce both conduction and switching losses. This part contains an integrated Schottky diode to reduce the Qrr of the body drain diode further reducing the losses in a Synchronous Buck circuit. The reduced losses make this product ideal for high frequency/high efficiency DC-DC converters that power high current loads such as the latest generation of microprocessors. The IRF6797MPbF has been optimized for parameters that are critical in synchronous buck converter's Sync FET sockets.

### Absolute Maximum Ratings

|  | Parameter   | Max. | Units |
|--|---|------|-------|
| V <sub>DS</sub>                        | Drain-to-Source Voltage                           | 25   | V     |
| V <sub>GS</sub>                        | Gate-to-Source Voltage                            | ±20  |       |
| I <sub>D</sub> @ T <sub>A</sub> = 25°C | Continuous Drain Current, V <sub>GS</sub> @ 10V ③ | 36   | A     |
| I <sub>D</sub> @ T <sub>A</sub> = 70°C | Continuous Drain Current, V <sub>GS</sub> @ 10V ③ | 29   |       |
| I <sub>D</sub> @ T <sub>C</sub> = 25°C | Continuous Drain Current, V <sub>GS</sub> @ 10V ④ | 210  |       |
| I <sub>DM</sub>                        | Pulsed Drain Current ⑤                            | 300  |       |
| E <sub>AS</sub>                        | Single Pulse Avalanche Energy ⑥                   | 260  | mJ    |
| I <sub>AR</sub>                        | Avalanche Current ⑤                               | 30   | A     |

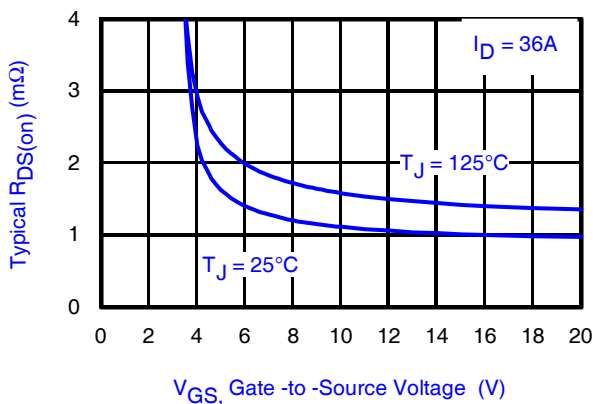

Fig 1. Typical On-Resistance vs. Gate Voltage

Notes:

- ① Click on this section to link to the appropriate technical paper.
- ② Click on this section to link to the DirectFET Website.
- ③ Surface mounted on 1 in. square Cu board, steady state.

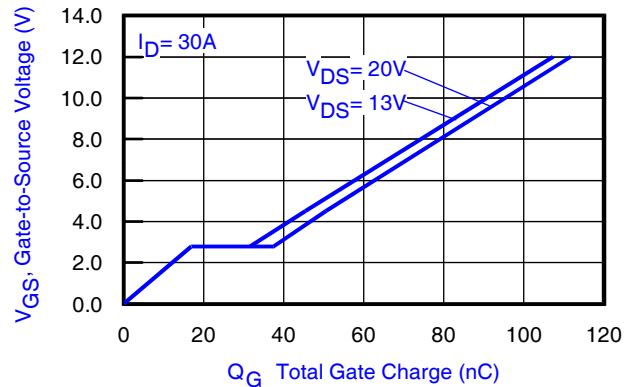

Fig 2. Typical Total Gate Charge vs. Gate-to-Source Voltage

- ④ T<sub>C</sub> measured with thermocouple mounted to top (Drain) of part.
- ⑤ Repetitive rating; pulse width limited by max. junction temperature.
- ⑥ Starting T<sub>J</sub> = 25°C, L = 0.57mH, R<sub>G</sub> = 25Ω, I<sub>AS</sub> = 30A.

## Static @ $T_J = 25^\circ\text{C}$ (unless otherwise specified)

|                                | Parameter                            | Min. | Typ. | Max. | Units | Conditions   |
|--------------------------------|--------------------------------------|------|------|------|-------|--|
| $BV_{DSS}$                     | Drain-to-Source Breakdown Voltage    | 25   | —    | —    | V     | $V_{GS} = 0V, I_D = 1.0mA$   |
| $\Delta BV_{DSS}/\Delta T_J$   | Breakdown Voltage Temp. Coefficient  | —    | 10   | —    | mV/°C | Reference to $25^\circ\text{C}, I_D = 10mA$  |
| $R_{DS(on)}$                   | Static Drain-to-Source On-Resistance | —    | 1.1  | 1.4  | mΩ    | $V_{GS} = 10V, I_D = 38A$ ⑦  |
|                                |                                      | —    | 1.8  | 2.4  |       | $V_{GS} = 4.5V, I_D = 30A$ ⑦   |
| $V_{GS(th)}$                   | Gate Threshold Voltage               | 1.35 | 1.8  | 2.35 | V     | $V_{DS} = V_{GS}, I_D = 150\mu A$  |
| $\Delta V_{GS(th)}/\Delta T_J$ | Gate Threshold Voltage Coefficient   | —    | -4.6 | —    | mV/°C | $V_{DS} = V_{GS}, I_D = 10mA$  |
| $I_{DSS}$                      | Drain-to-Source Leakage Current      | —    | —    | 500  | μA    | $V_{DS} = 20V, V_{GS} = 0V$  |
|                                |                                      | —    | —    | 5.0  | mA    | $V_{DS} = 20V, V_{GS} = 0V, T_J = 125^\circ\text{C}$                               |
| $I_{GSS}$                      | Gate-to-Source Forward Leakage       | —    | —    | 100  | nA    | $V_{GS} = 20V$   |
|                                | Gate-to-Source Reverse Leakage       | —    | —    | -100 | nA    | $V_{GS} = -20V$  |
| $g_{fs}$                       | Forward Transconductance             | 130  | —    | —    | S     | $V_{DS} = 13V, I_D = 30A$  |
| $Q_g$                          | Total Gate Charge                    | —    | 45   | 68   | nC    | $V_{DS} = 13V$<br>$V_{GS} = 4.5V$<br>$I_D = 30A$<br>See Fig. 15                    |
| $Q_{gs1}$                      | Pre-Vth Gate-to-Source Charge        | —    | 12   | —    |       |  |
| $Q_{gs2}$                      | Post-Vth Gate-to-Source Charge       | —    | 6.2  | —    |       |  |
| $Q_{gd}$                       | Gate-to-Drain Charge                 | —    | 13   | —    |       |  |
| $Q_{godr}$                     | Gate Charge Overdrive                | —    | 14   | —    |       |  |
| $Q_{sw}$                       | Switch Charge ( $Q_{gs2} + Q_{gd}$ ) | —    | 19.2 | —    |       |  |
| $Q_{oss}$                      | Output Charge                        | —    | 38   | —    | nC    | $V_{DS} = 16V, V_{GS} = 0V$  |
| $R_G$                          | Gate Resistance                      | —    | 1.3  | 2.2  | Ω     |  |
| $t_{d(on)}$                    | Turn-On Delay Time                   | —    | 22   | —    | ns    | $V_{DD} = 13V, V_{GS} = 4.5V$ ⑦<br>$I_D = 30A$<br>$R_G = 1.8\Omega$<br>See Fig. 17 |
| $t_r$                          | Rise Time                            | —    | 32   | —    |       |  |
| $t_{d(off)}$                   | Turn-Off Delay Time                  | —    | 20   | —    |       |  |
| $t_f$                          | Fall Time                            | —    | 15   | —    |       |  |
| $C_{iss}$                      | Input Capacitance                    | —    | 5790 | —    | pF    | $V_{GS} = 0V$<br>$V_{DS} = 13V$<br>$f = 1.0MHz$                                    |
| $C_{oss}$                      | Output Capacitance                   | —    | 1790 | —    |       |  |
| $C_{rss}$                      | Reverse Transfer Capacitance         | —    | 720  | —    |       |  |

## Diode Characteristics

|          | Parameter                                 | Min. | Typ. | Max. | Units | Conditions  |
|----------|---|------|------|------|-------|---|
| $I_S$    | Continuous Source Current<br>(Body Diode) | —    | —    | 36   | A     | MOSFET symbol<br>showing the<br>integral reverse<br>p-n junction diode. |
| $I_{SM}$ | Pulsed Source Current<br>(Body Diode) ⑧   | —    | —    | 300  |       |   |
| $V_{SD}$ | Diode Forward Voltage                     | —    | —    | 0.65 | V     | $T_J = 25^\circ\text{C}, I_S = 30A, V_{GS} = 0V$ ⑦                      |
| $t_{rr}$ | Reverse Recovery Time                     | —    | 30   | 45   | ns    | $T_J = 25^\circ\text{C}, I_F = 30A$                                     |
| $Q_{rr}$ | Reverse Recovery Charge                   | —    | 38   | 57   | nC    | $di/dt = 200A/\mu s$ ⑦  |

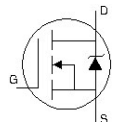

### Notes:

⑦ Pulse width  $\leq 400\mu s$ ; duty cycle  $\leq 2\%$ .

**Absolute Maximum Ratings**

|                                | Parameter                  | Max.         | Units            |
|--------------------------------|----------------------------|--------------|------------------|
| $P_D @ T_A = 25^\circ\text{C}$ | Power Dissipation ③        | 2.8          | W                |
| $P_D @ T_A = 70^\circ\text{C}$ | Power Dissipation ③        | 1.8          |                  |
| $P_D @ T_C = 25^\circ\text{C}$ | Power Dissipation ④        | 89           |                  |
| $T_P$                          | Peak Soldering Temperature | 270          | $^\circ\text{C}$ |
| $T_J$                          | Operating Junction and     | -40 to + 150 |                  |
| $T_{STG}$                      | Storage Temperature Range  |              |                  |

**Thermal Resistance**

|                    | Parameter                | Typ. | Max.  | Units                     |
|--------------------|--------------------------|------|-------|---------------------------|
| $R_{\theta JA}$    | Junction-to-Ambient ③④   | —    | 45    | $^\circ\text{C/W}$        |
| $R_{\theta JA}$    | Junction-to-Ambient ③④   | 12.5 | —     |                           |
| $R_{\theta JA}$    | Junction-to-Ambient ⑨④   | 20   | —     |                           |
| $R_{\theta JC}$    | Junction-to-Case ④④      | —    | 1.4   |                           |
| $R_{\theta J-PCB}$ | Junction-to-PCB Mounted  | 1.0  | —     |                           |
|                    | Linear Derating Factor ③ |      | 0.022 | $\text{W}/^\circ\text{C}$ |

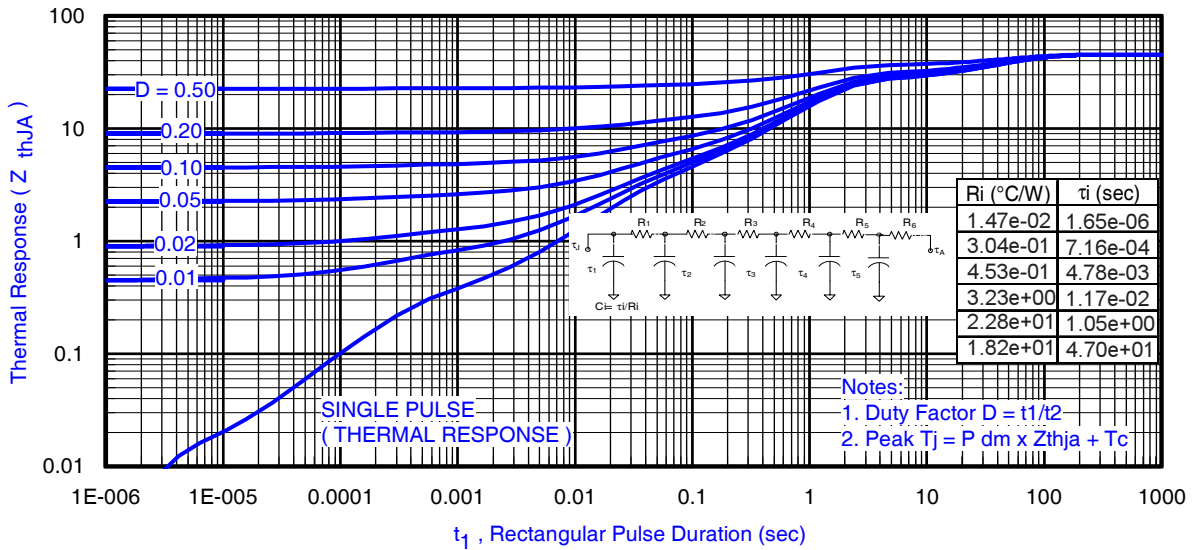

**Fig 3.** Maximum Effective Transient Thermal Impedance, Junction-to-Ambient ③  
(At lower pulse widths  $Z_{thJA}$  &  $Z_{thJC}$  are combined)

**Notes:**

- ③ Used double sided cooling , mounting pad with large heatsink.
- ④  $R_{\theta}$  is measured at  $T_J$  of approximately  $90^\circ\text{C}$ .
- ⑨ Mounted on minimum footprint full size board with metalized back and with small clip heatsink.



③ Surface mounted on 1 in. square Cu (still air).



⑨ Mounted to a PCB with small clip heatsink (still air)



⑨ Mounted on minimum footprint full size board with metalized back and with small clip heatsink (still air)

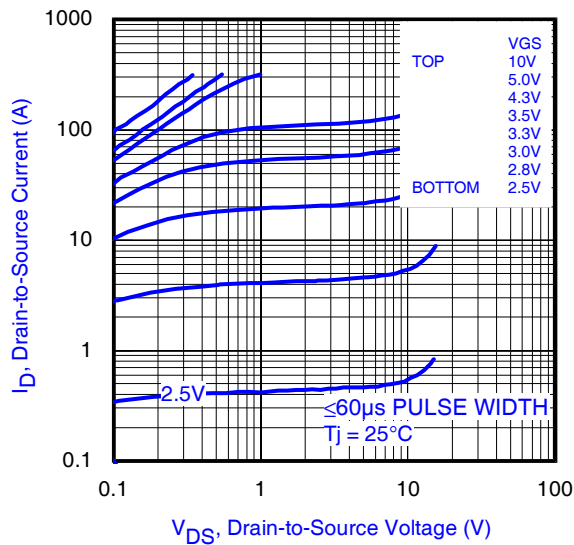

**Fig 4.** Typical Output Characteristics

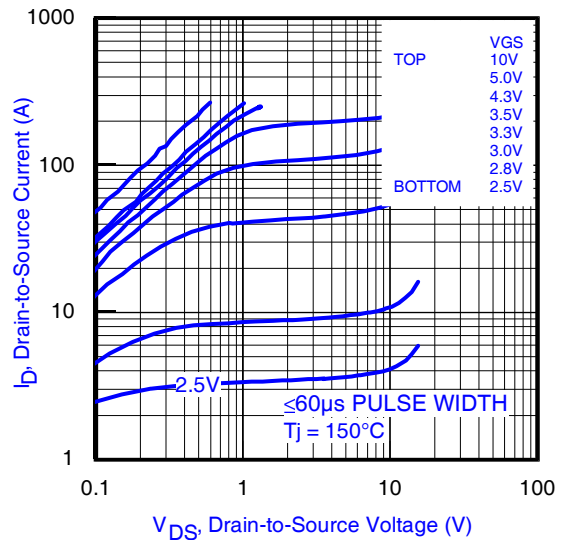

**Fig 5.** Typical Output Characteristics

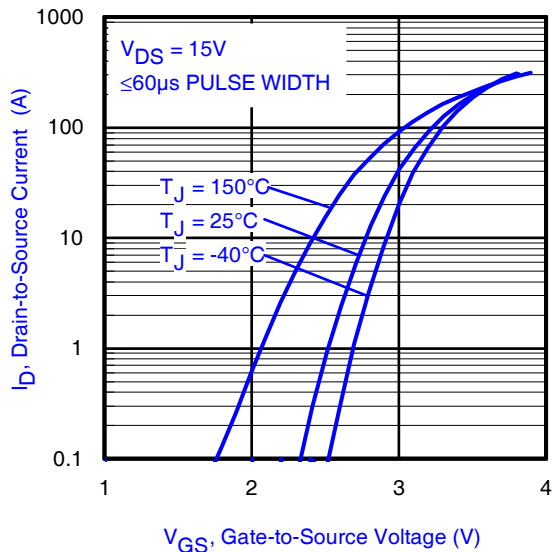

**Fig 6.** Typical Transfer Characteristics

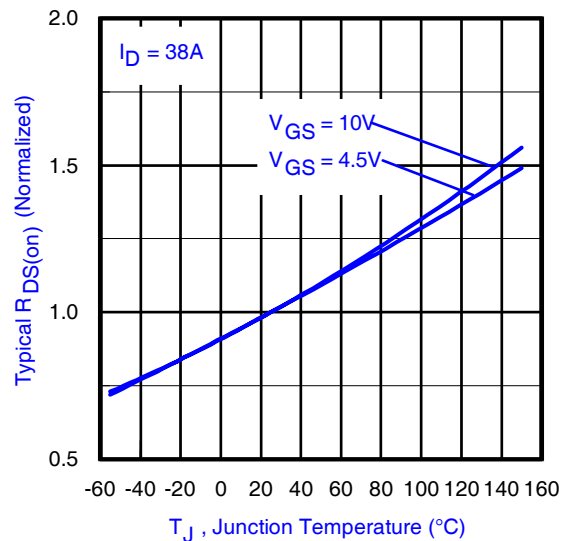

**Fig 7.** Normalized On-Resistance vs. Temperature

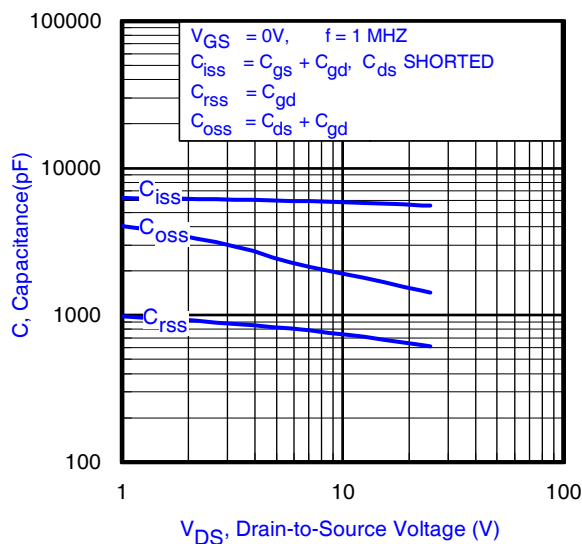

**Fig 8.** Typical Capacitance vs. Drain-to-Source Voltage

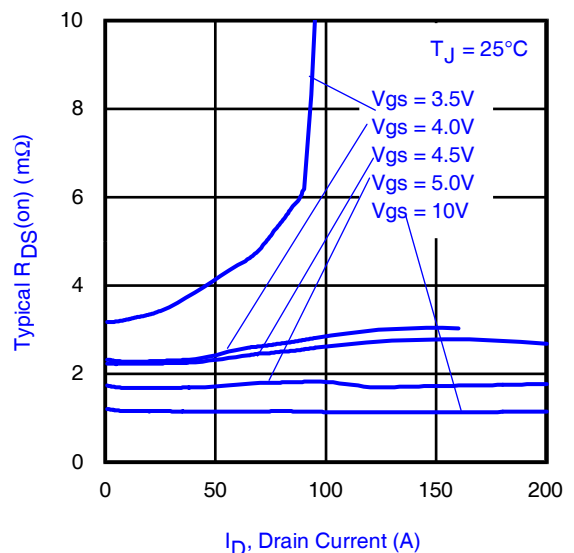

**Fig 9.** Typical On-Resistance vs. Drain Current and Gate Voltage

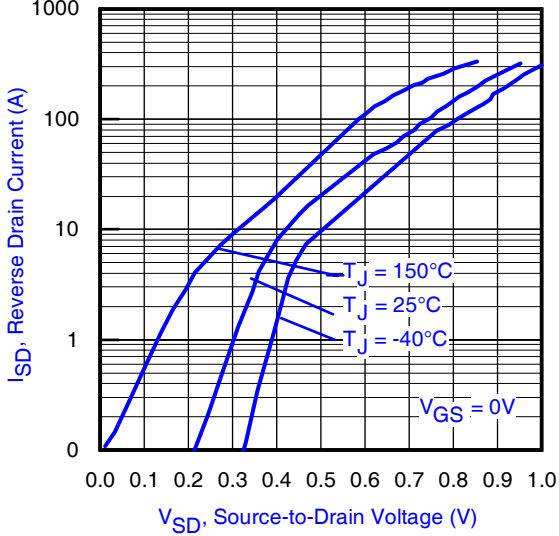

Fig 10. Typical Source-Drain Diode Forward Voltage

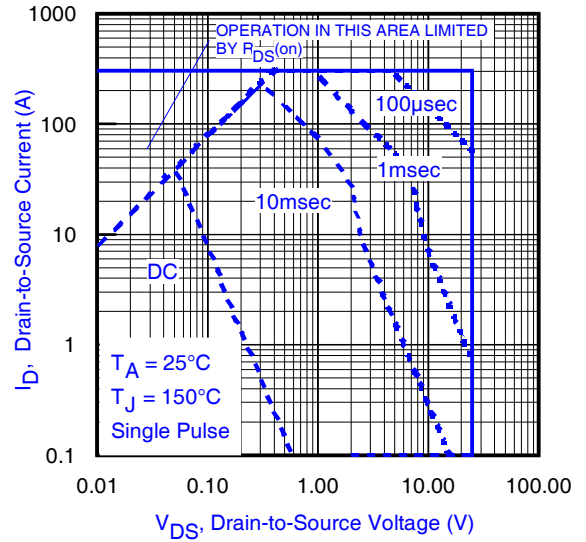

Fig11. Maximum Safe Operating Area

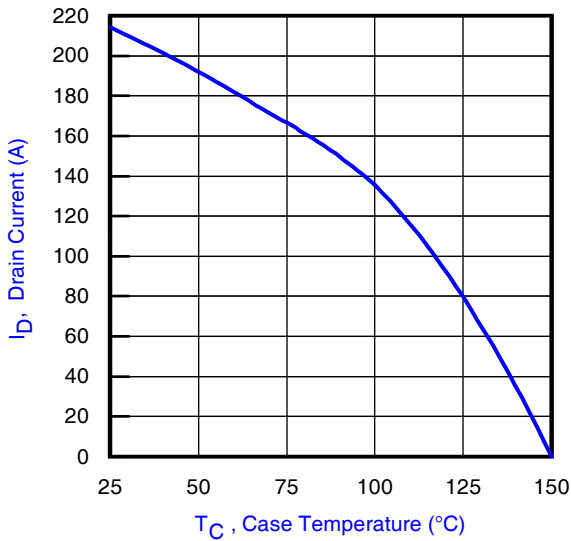

Fig 12. Maximum Drain Current vs. Case Temperature

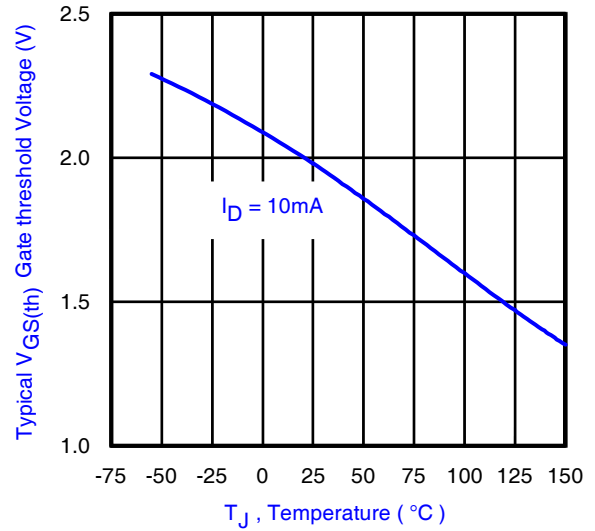

Fig 13. Typical Threshold Voltage vs. Junction Temperature

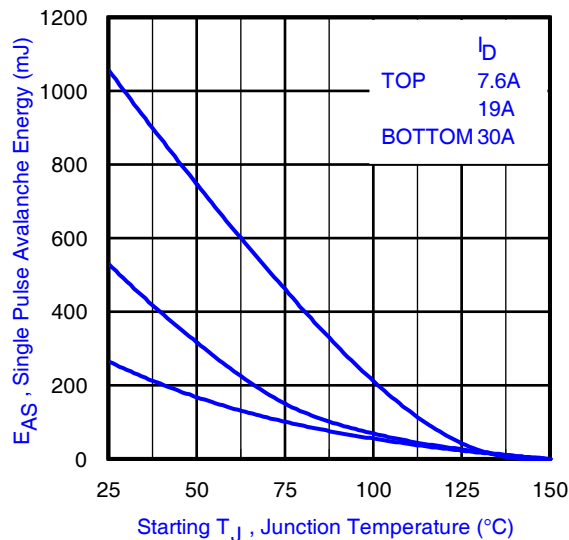

Fig 14. Maximum Avalanche Energy vs. Drain Current



**Fig 15a.** Gate Charge Test Circuit



**Fig 15b.** Gate Charge Waveform

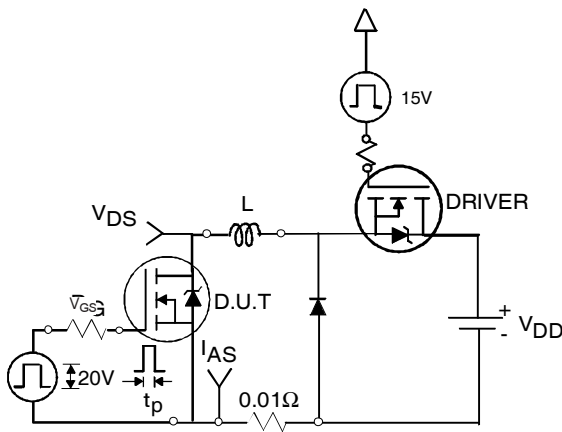

**Fig 16a.** Unclamped Inductive Test Circuit

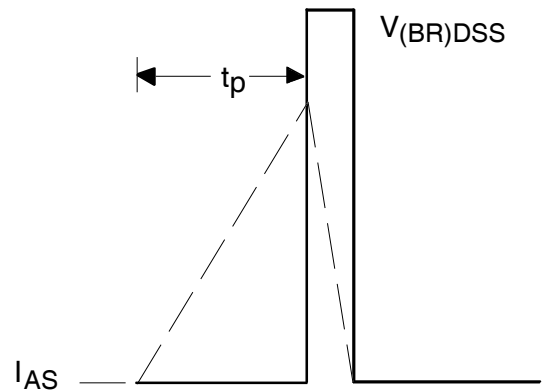

**Fig 16b.** Unclamped Inductive Waveforms

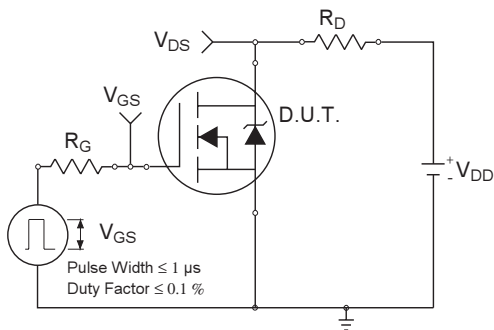

**Fig 17a.** Switching Time Test Circuit



**Fig 17b.** Switching Time Waveforms

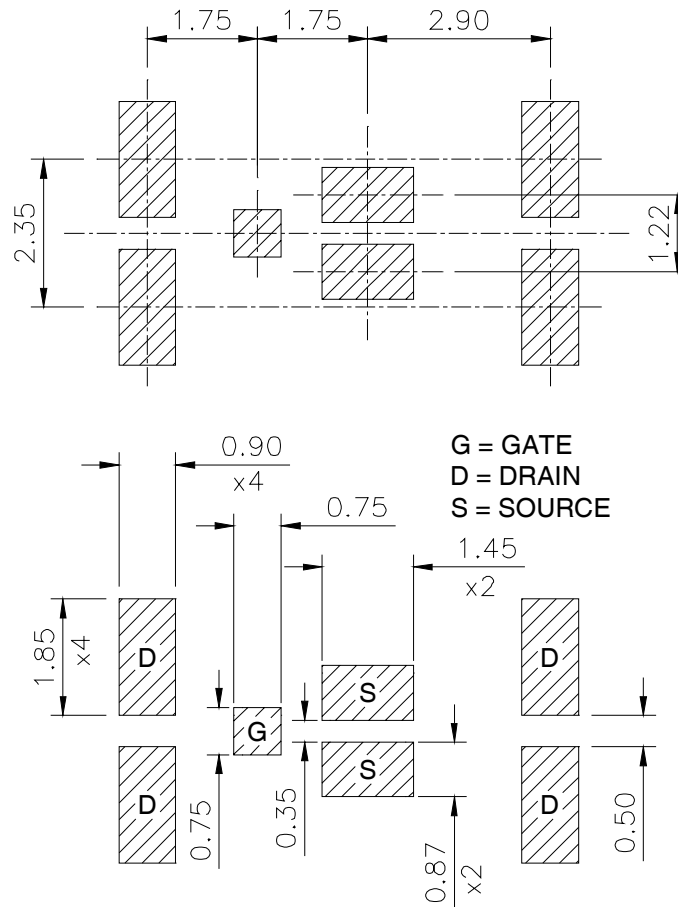

**Fig 18. Diode Reverse Recovery Test Circuit for HEXFET® Power MOSFETs**

### DirectFET™ Board Footprint, MX Outline (Medium Size Can, X-Designation).

Please see DirectFET application note AN-1035 for all details regarding the assembly of DirectFET.

This includes all recommendations for stencil and substrate designs.



# IRF6797MTRPbF

## DirectFET™ Outline Dimension, MX Outline (Medium Size Can, X-Designation).

Please see DirectFET application note AN-1035 for all details regarding the assembly of DirectFET. This includes all recommendations for stencil and substrate designs.

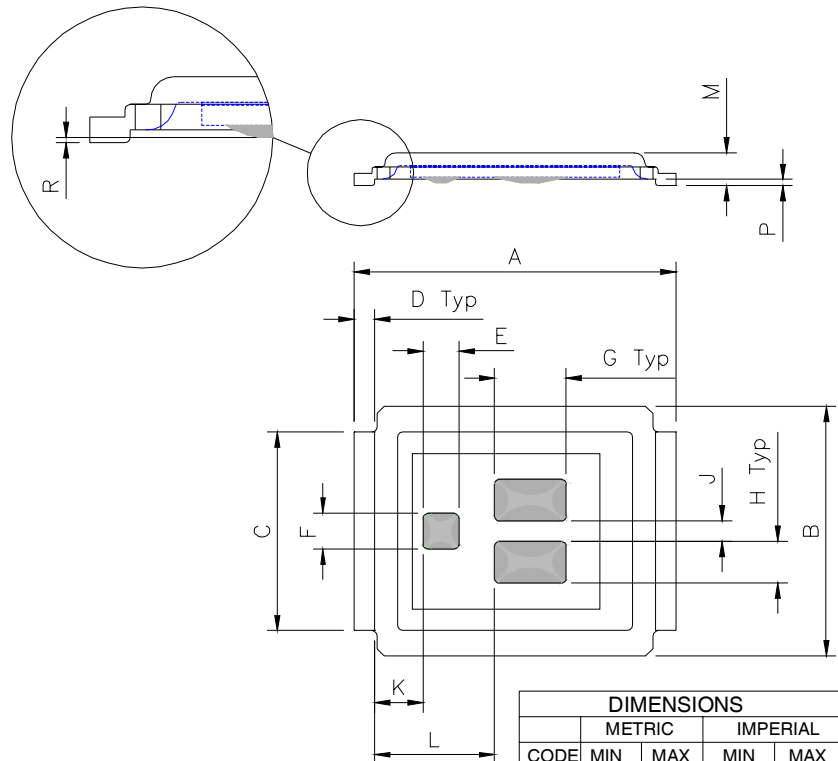

| CODE | METRIC |       | IMPERIAL |        |
|------|--------|-------|----------|--------|
|      | MIN    | MAX   | MIN      | MAX    |
| A    | 6.25   | 6.35  | 0.246    | 0.250  |
| B    | 4.80   | 5.05  | 0.189    | 0.201  |
| C    | 3.85   | 3.95  | 0.152    | 0.156  |
| D    | 0.35   | 0.45  | 0.014    | 0.018  |
| E    | 0.68   | 0.72  | 0.027    | 0.028  |
| F    | 0.68   | 0.72  | 0.027    | 0.028  |
| G    | 1.38   | 1.42  | 0.054    | 0.056  |
| H    | 0.80   | 0.84  | 0.032    | 0.033  |
| J    | 0.38   | 0.42  | 0.015    | 0.017  |
| K    | 0.88   | 1.01  | 0.035    | 0.039  |
| L    | 2.28   | 2.41  | 0.090    | 0.095  |
| M    | 0.616  | 0.676 | 0.0235   | 0.0274 |
| R    | 0.020  | 0.080 | 0.0008   | 0.0031 |
| P    | 0.08   | 0.17  | 0.003    | 0.007  |

## DirectFET™ Part Marking

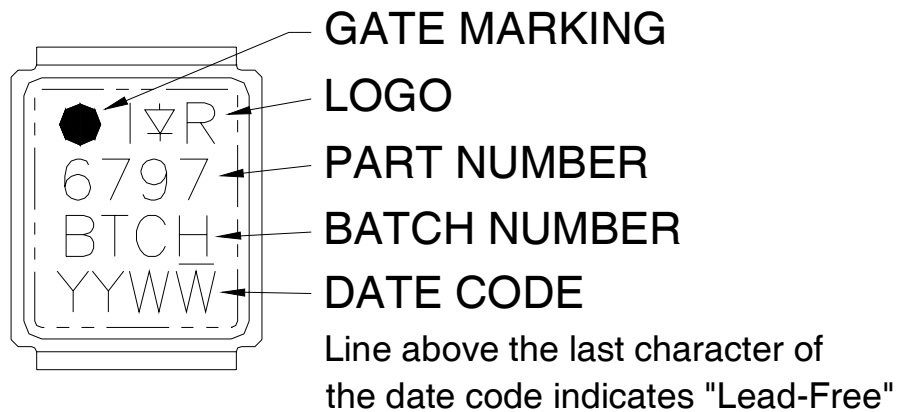



## DirectFET™ Tape & Reel Dimension (Showing component orientation).

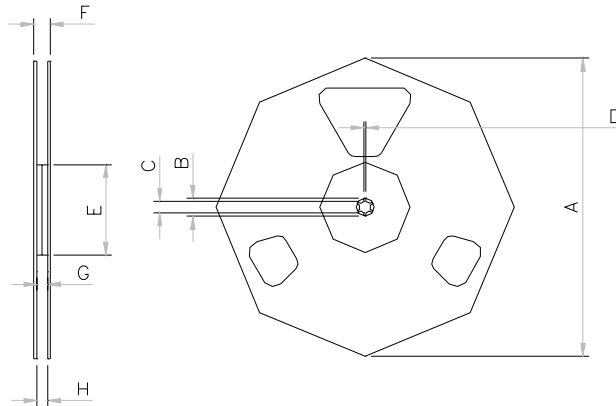

NOTE: Controlling dimensions in mm  
 Std reel quantity is 4800 parts. (ordered as IRF6797MTRPbF). For 1000 parts on 7" reel, order IRF6797MTR1PbF

| REEL DIMENSIONS |                            |      |          |       |                       |       |          |      |
|-----------------|----------------------------|------|----------|-------|-----------------------|-------|----------|------|
| CODE            | STANDARD OPTION (QTY 4800) |      |          |       | TR1 OPTION (QTY 1000) |       |          |      |
|                 | METRIC                     |      | IMPERIAL |       | METRIC                |       | IMPERIAL |      |
| A               | 330.0                      | N.C  | 12.992   | N.C   | 177.77                | N.C   | 6.9      | N.C  |
| B               | 20.2                       | N.C  | 0.795    | N.C   | 19.06                 | N.C   | 0.75     | N.C  |
| C               | 12.8                       | 13.2 | 0.504    | 0.520 | 13.5                  | 12.8  | 0.53     | 0.50 |
| D               | 1.5                        | N.C  | 0.059    | N.C   | 1.5                   | N.C   | 0.059    | N.C  |
| E               | 100.0                      | N.C  | 3.937    | N.C   | 58.72                 | N.C   | 2.31     | N.C  |
| F               | N.C                        | 18.4 | N.C      | 0.724 | N.C                   | 13.50 | N.C      | 0.53 |
| G               | 12.4                       | 14.4 | 0.488    | 0.567 | 11.9                  | 12.01 | 0.47     | N.C  |
| H               | 11.9                       | 15.4 | 0.469    | 0.606 | 11.9                  | 12.01 | 0.47     | N.C  |

LOADED TAPE FEED DIRECTION

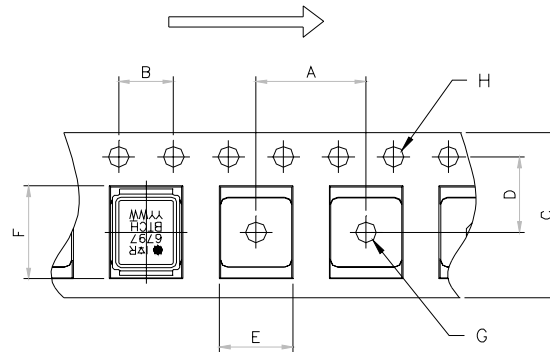

NOTE: CONTROLLING DIMENSIONS IN MM

| CODE | DIMENSIONS |       |          |       |
|------|------------|-------|----------|-------|
|      | METRIC     |       | IMPERIAL |       |
| A    | 7.90       | 8.10  | 0.311    | 0.319 |
| B    | 3.90       | 4.10  | 0.154    | 0.161 |
| C    | 11.90      | 12.30 | 0.469    | 0.484 |
| D    | 5.45       | 5.55  | 0.215    | 0.219 |
| E    | 5.10       | 5.30  | 0.201    | 0.209 |
| F    | 6.50       | 6.70  | 0.256    | 0.264 |
| G    | 1.50       | N.C   | 0.059    | N.C   |
| H    | 1.50       | 1.60  | 0.059    | 0.063 |

Data and specifications subject to change without notice.  
 This product has been designed and qualified for the Consumer market.  
 Qualification Standards can be found on IR's Web site.

# X-ON Electronics

Largest Supplier of Electrical and Electronic Components

*Click to view similar products for [MOSFET](#) category:*

*Click to view products by [Infineon](#) manufacturer:*

Other Similar products are found below :

[614233C](#) [648584F](#) [D2003UK](#) [705463DB](#) [MCH6422-TL-E](#) [FW231A-TL-E](#) [APT5010JFLL](#) [NTNS3A92PZT5G](#) [IRF100S201](#) [JANTX2N5237](#)  
[2SK2464-TL-E](#) [2SK3818-DL-E](#) [FCA20N60\\_F109](#) [FDZ595PZ](#) [STD6600NT4G](#) [FQD4P40TM\\_AM002](#) [FSS804-TL-E](#) [FW217A-TL-2W](#)  
[APT10050JVFR](#) [2SJ277-DL-E](#) [2SK1691-DL-E](#) [2SK2545\(Q,T\)](#) [D1014UK](#) [D2294UK](#) [405094E](#) [423220D](#) [MCH6646-TL-E](#) [TPCC8103,L1Q\(CM](#)  
[IRF3710](#) [367-8430-0972-503](#) [VN1206L](#) [424134F](#) [026935X](#) [051075F](#) [SBVS138LT1G](#) [614234A](#) [715780A](#) [NTNS3166NZT5G](#) [751625C](#) [873612G](#)  
[IPS70R2K0CEAKMA1](#) [APT8015JVFR](#) [APT50M85JVR](#) [APT5010JVFR](#) [APT12031JFLL](#) [APT12040JVR](#) [NTE6400](#) [NVC3S5A51PLZT1G](#)  
[JANTX2N6796U](#) [JANTX2N6784U](#)