

HEXFET® Power MOSFET

V_{DSS}	25	V
R_{DS(on)} max (@ V _{GS} = 10V)	1.35	mΩ
(@ V _{GS} = 4.5V)	1.90	
Qg (typical)	26	nC
I_D (@T _{C (Bottom)} = 25°C)	204 Ⓢ	A

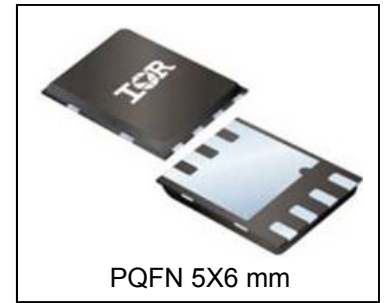
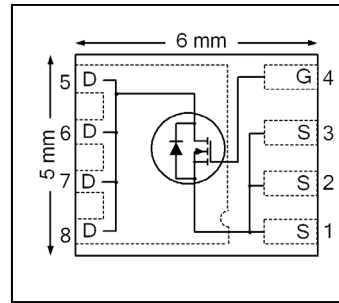

Applications

- Synchronous Rectifier MOSFET for Synchronous Buck Converters
- Secondary Synchronous Rectifier MOSFET for isolated DC-DC converters
- Active ORing and Hot Swap
- Battery Operated DC Motor Inverters

Features

Low R _{DS(on)} (<1.35mΩ)
Low Thermal Resistance to PCB (<1.4°C/W)
Low Profile (<0.9 mm)
Industry-Standard Pinout
Compatible with Existing Surface Mount Techniques
RoHS Compliant, Halogen-Free
MSL1, Industrial Qualification

results in
⇒

Benefits

Lower Conduction Losses
Enable better thermal dissipation
Increased Power Density
Multi-Vendor Compatibility
Easier Manufacturing
Environmentally Friendlier
Increased Reliability

Base part number	Package Type	Standard Pack		Orderable Part Number
		Form	Quantity	
IRFH4213PbF	PQFN 5mm x 6 mm	Tape and Reel	4000	IRFH4213TRPbF

Absolute Maximum Ratings

	Parameter	Max.	Units
V _{GS}	Gate-to-Source Voltage	± 20	V
I _D @ T _A = 25°C	Continuous Drain Current, V _{GS} @ 10V	41	A
I _D @ T _{C(Bottom)} = 25°C	Continuous Drain Current, V _{GS} @ 10V	204Ⓢ	
I _D @ T _{C(Bottom)} = 100°C	Continuous Drain Current, V _{GS} @ 10V	129Ⓢ	
I _{DM}	Pulsed Drain Current ①	400	
P _D @ T _A = 25°C	Power Dissipation ⑤	3.6	W
P _D @ T _{C(Bottom)} = 25°C	Power Dissipation ⑤	89	
	Linear Derating Factor ⑤	0.029	W/°C
T _J T _{STG}	Operating Junction and Storage Temperature Range	-55 to + 150	°C

Notes ① through ⑤ are on page 8

Static @ T_J = 25°C (unless otherwise specified)

	Parameter	Min.	Typ.	Max.	Units	Conditions	
BV _{DSS}	Drain-to-Source Breakdown Voltage	25	—	—	V	V _{GS} = 0V, I _D = 250μA	
ΔBV _{DSS} /ΔT _J	Breakdown Voltage Temp. Coefficient	—	21	—	mV/°C	Reference to 25°C, I _D = 1mA	
R _{DS(on)}	Static Drain-to-Source On-Resistance	—	1.10	1.35	mΩ	V _{GS} = 10V, I _D = 50A ③	
		—	1.50	1.90		V _{GS} = 4.5V, I _D = 50A ③	
V _{GS(th)}	Gate Threshold Voltage	1.1	1.6	2.1	V	V _{DS} = V _{GS} , I _D = 100μA	
ΔV _{GS(th)}	Gate Threshold Voltage Coefficient	—	-5.8	—	mV/°C		
I _{DSS}	Drain-to-Source Leakage Current	—	—	1.0	μA	V _{DS} = 20V, V _{GS} = 0V	
I _{GSS}	Gate-to-Source Forward Leakage	—	—	100	nA	V _{GS} = 20V	
	Gate-to-Source Reverse Leakage	—	—	-100		V _{GS} = -20V	
g _{fs}	Forward Transconductance	228	—	—	S	V _{DS} = 10V, I _D = 50A	
Q _g	Total Gate Charge	—	54	—	nC	V _{GS} = 10V, V _{DS} = 13V, I _D = 50A	
Q _g	Total Gate Charge	—	26	39	nC	V _{DS} = 13V V _{GS} = 4.5V I _D = 50A	
	Q _{gs1}	Pre-V _{th} Gate-to-Source Charge	—	7.3			—
	Q _{gs2}	Post-V _{th} Gate-to-Source Charge	—	3.4			—
	Q _{gd}	Gate-to-Drain Charge	—	9.2			—
	Q _{godr}	Gate Charge Overdrive	—	6.1			—
Q _{sw}	Switch Charge (Q _{gs2} + Q _{gd})	—	12.6	—			
Q _{oss}	Output Charge	—	25	—	nC	V _{DS} = 16V, V _{GS} = 0V	
R _G	Gate Resistance	—	1.5	—	Ω		
t _{d(on)}	Turn-On Delay Time	—	14	—	ns	V _{DD} = 13V, V _{GS} = 4.5V I _D = 50A R _G = 2.0Ω	
t _r	Rise Time	—	35	—			
t _{d(off)}	Turn-Off Delay Time	—	17	—			
t _f	Fall Time	—	12	—			
C _{iss}	Input Capacitance	—	3420	—	pF	V _{GS} = 0V V _{DS} = 13V f = 1.0MHz	
C _{oss}	Output Capacitance	—	940	—			
C _{rss}	Reverse Transfer Capacitance	—	240	—			

Avalanche Characteristics

	Parameter	Typ.	Max.
E _{AS}	Single Pulse Avalanche Energy ②	—	134
I _{AR}	Avalanche Current ①	—	50

Diode Characteristics

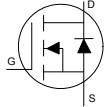
	Parameter	Min.	Typ.	Max.	Units	Conditions
I _S	Continuous Source Current (Body Diode)	—	—	204⑥	A	MOSFET symbol showing the integral reverse p-n junction diode. 
I _{SM}	Pulsed Source Current (Body Diode) ①	—	—	400		
V _{SD}	Diode Forward Voltage	—	—	1.0	V	T _J = 25°C, I _S = 50A, V _{GS} = 0V ③
t _{rr}	Reverse Recovery Time	—	23	35	ns	T _J = 25°C, I _F = 50A, V _{DD} = 13V
Q _{rr}	Reverse Recovery Charge	—	37	56	nC	di/dt = 360A/μs ③

Thermal Resistance

	Parameter	Typ.	Max.	Units
R _{θJC} (Bottom)	Junction-to-Case ④	—	1.4	°C/W
R _{θJC} (Top)	Junction-to-Case ④	—	21	
R _{θJA}	Junction-to-Ambient ⑤	—	35	
R _{θJA} (<10s)	Junction-to-Ambient ⑤	—	21	

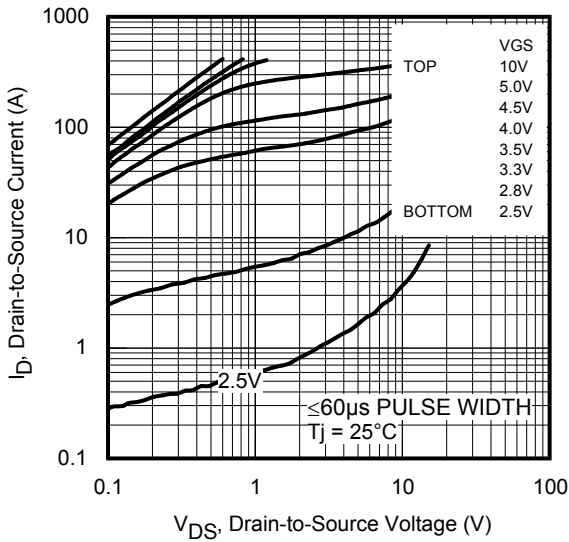
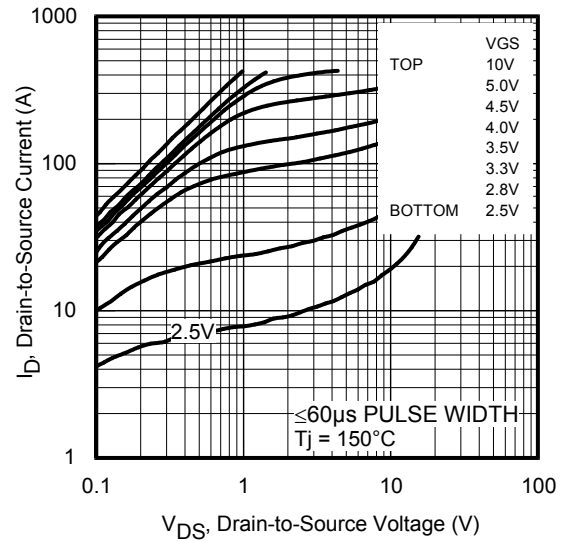
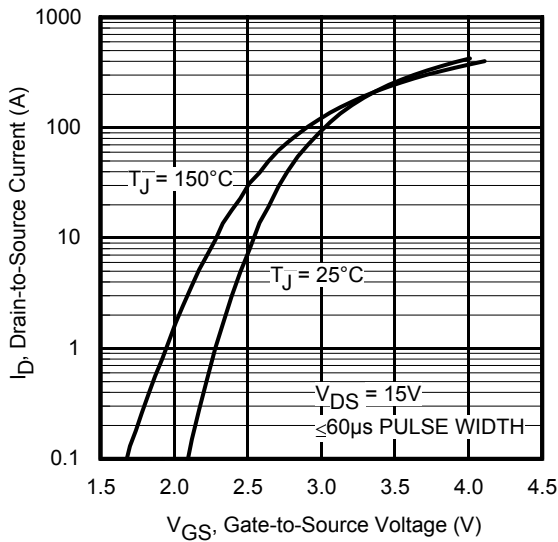
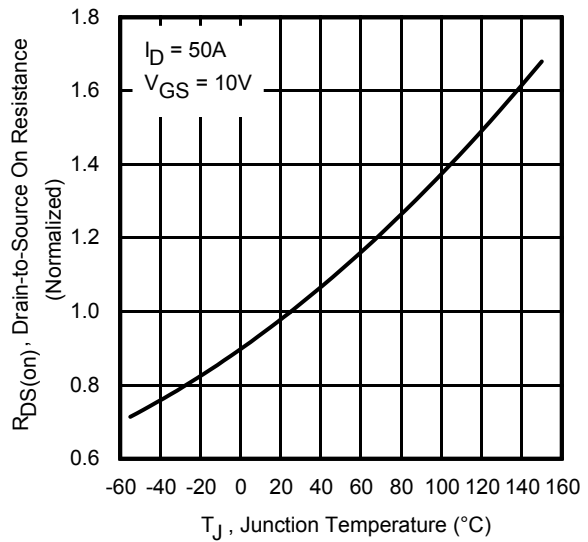
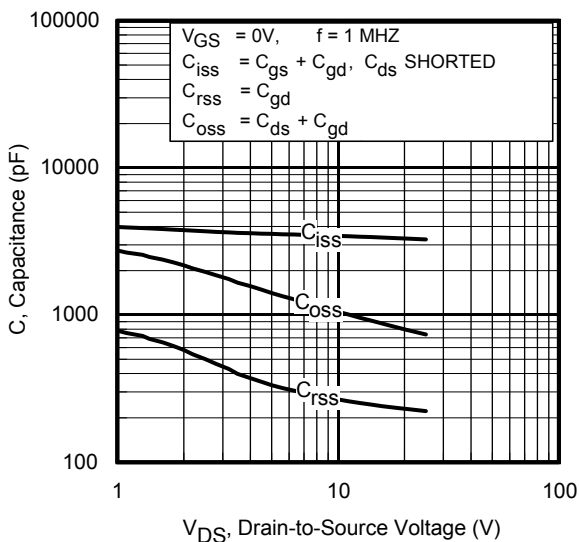
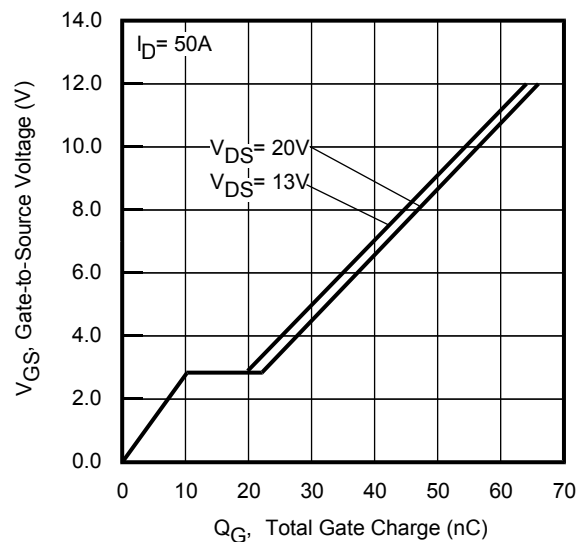
Fig 1. Typical Output Characteristics

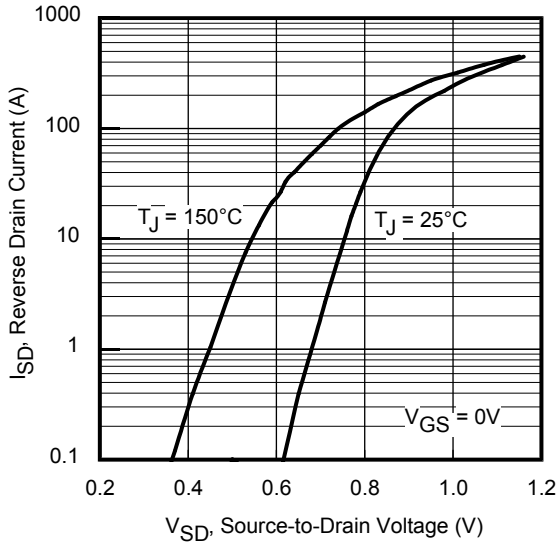
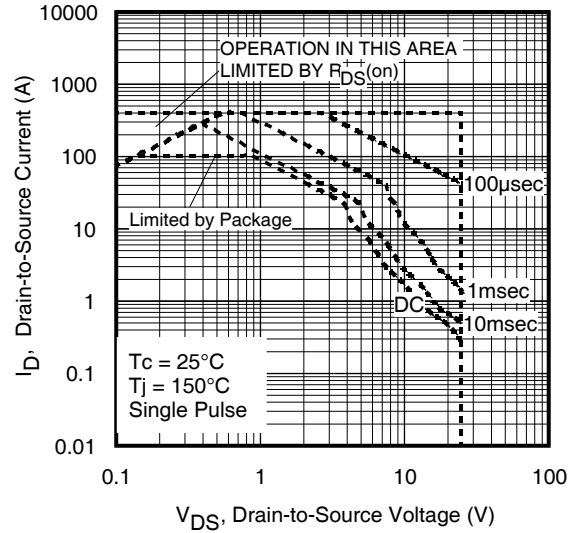
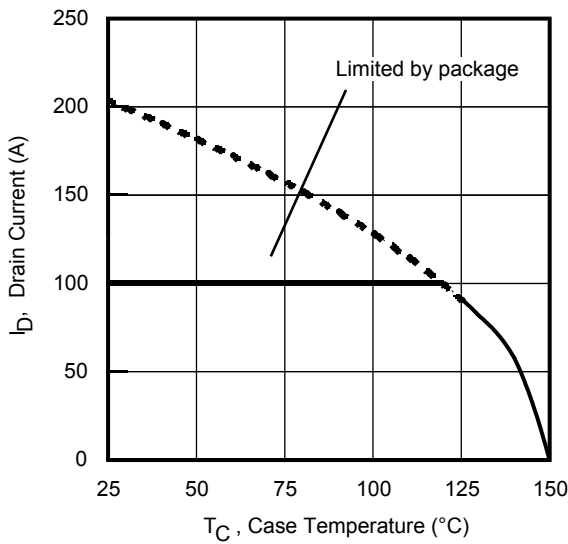
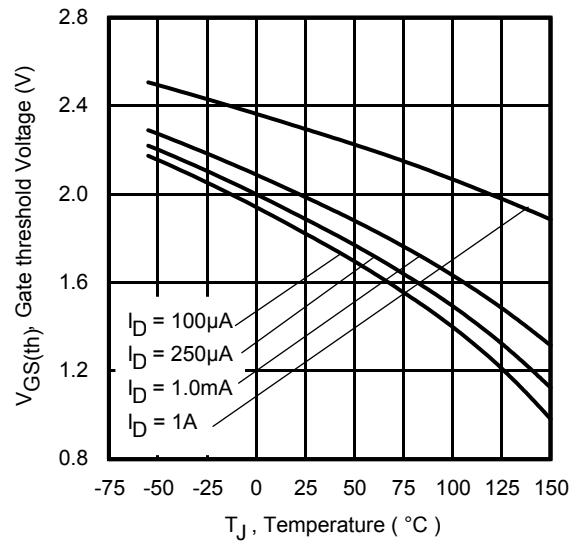
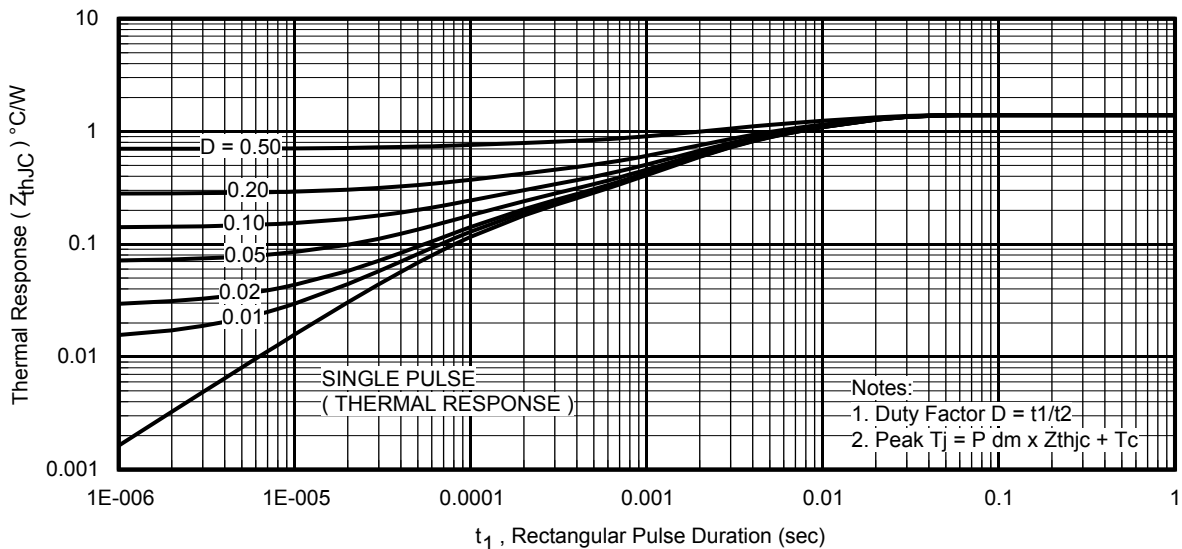
Fig 2. Typical Output Characteristics

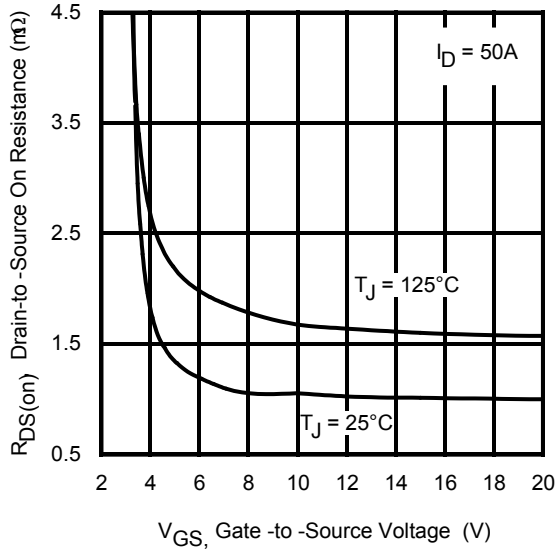
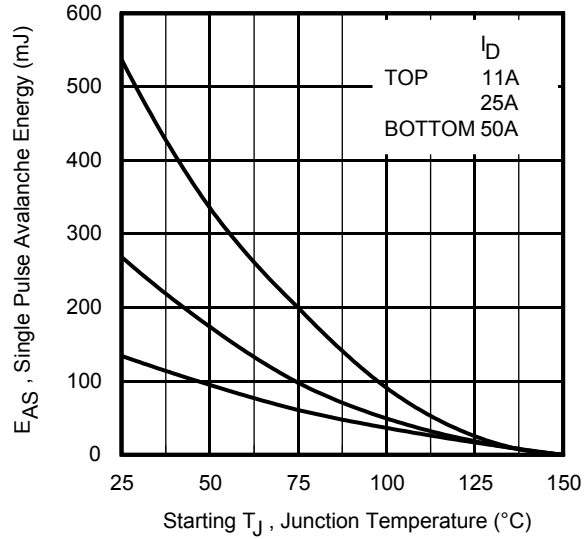
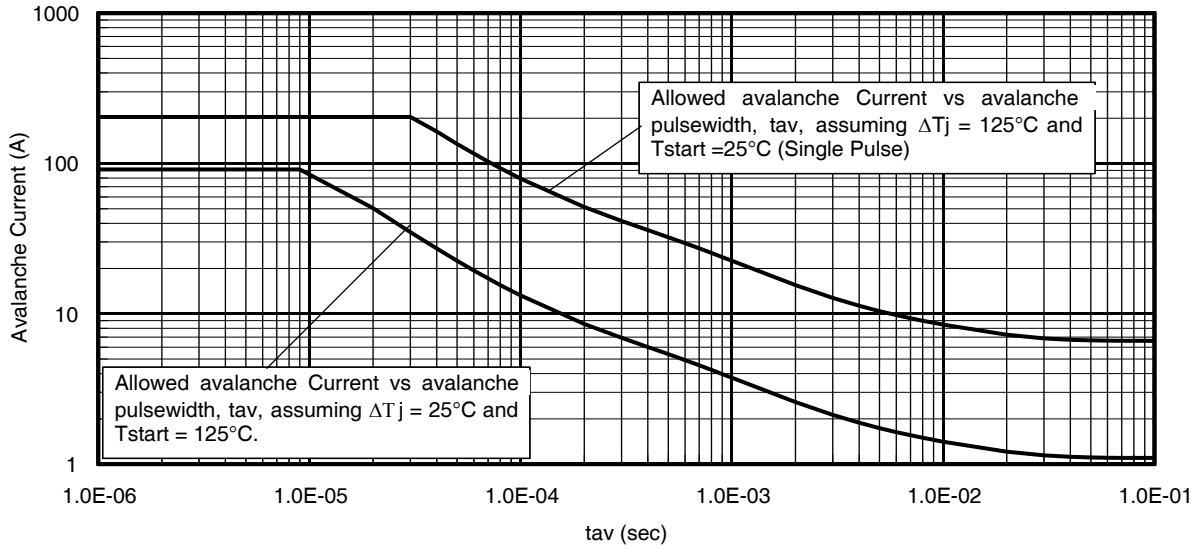
Fig 3. Typical Transfer Characteristics

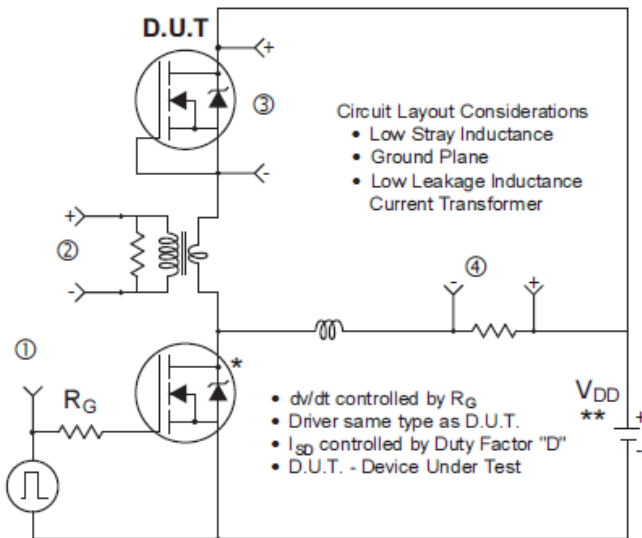
Fig 4. Normalized On-Resistance vs. Temperature

Fig 5. Typical Capacitance vs. Drain-to-Source Voltage

Fig 6. Typical Gate Charge vs. Gate-to-Source Voltage

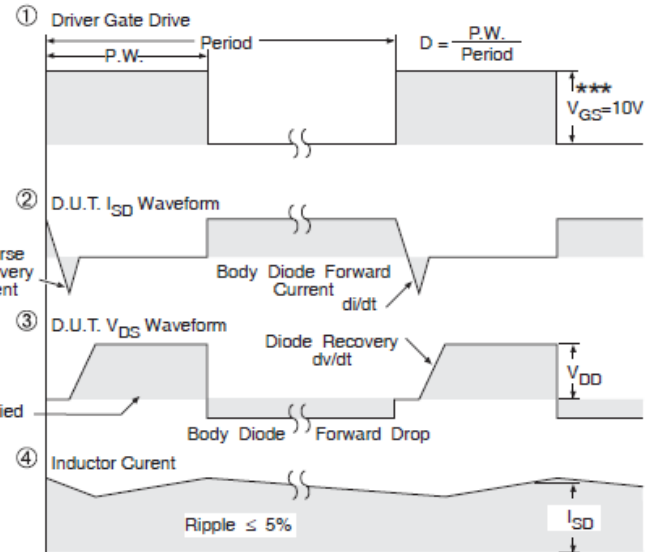

Fig 7. Typical Source-Drain Diode Forward Voltage

Fig 8. Maximum Safe Operating Area

Fig 9. Maximum Drain Current vs. Case Temperature

Fig 10. Threshold Voltage Vs. Temperature

Fig 11. Maximum Effective Transient Thermal Impedance, Junction-to-Case

Fig 12. On-Resistance vs. Gate Voltage

Fig 13. Maximum Avalanche Energy vs. Drain Current

Fig 14. Typical Avalanche Current vs. Pulsewidth



* Use P-Channel Driver for P-Channel Measurements

** Reverse Polarity for P-Channel



*** $V_{GS} = 5V$ for Logic Level Devices

Fig 15. Peak Diode Recovery dv/dt Test Circuit for N-Channel HEXFET® Power MOSFETs

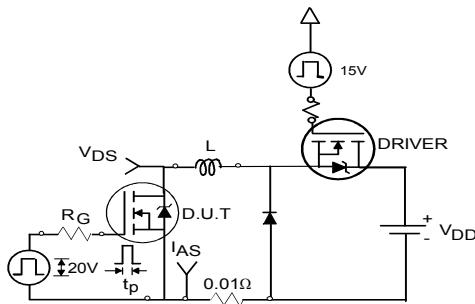

Fig 16a. Unclamped Inductive Test Circuit

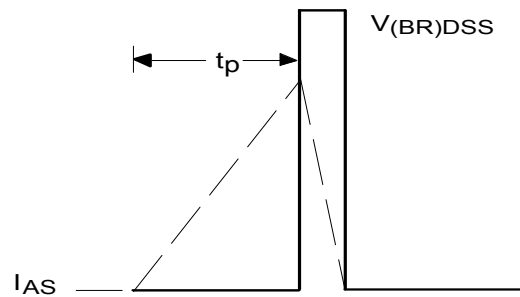

Fig 16b. Unclamped Inductive Waveforms

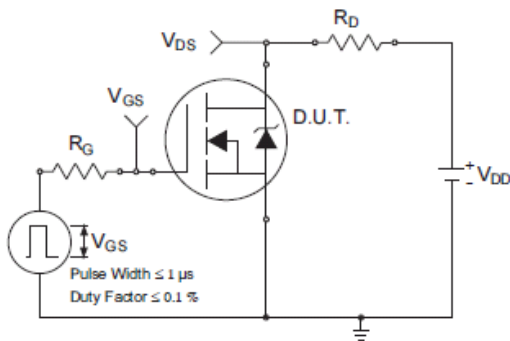

Fig 17a. Switching Time Test Circuit

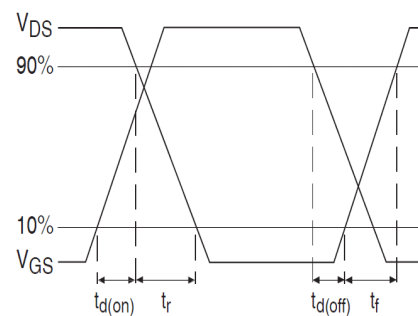

Fig 17b. Switching Time Waveforms

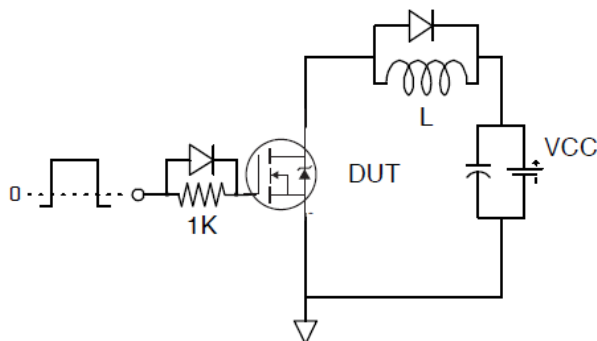

Fig 18. Gate Charge Test Circuit

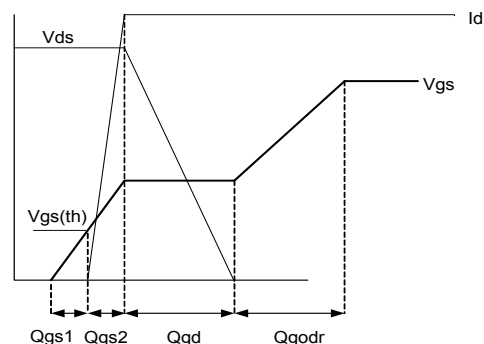
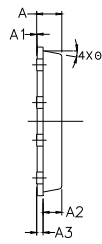
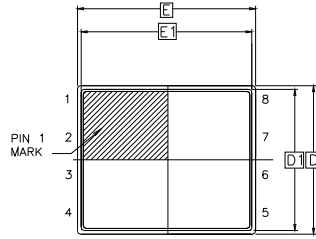

Fig 19. Gate Charge Waveform

PQFN 5x6 Outline "B" Package Details

SIDE VIEW



TOP VIEW

SYMBOL	DIM	MIN	NOM	MAX
A		0.800	0.830	1.05
A1		0.000	0.020	0.050
A2		0.580	0.630	0.680
A3			0.254 REF	
Ø		0"	10"	12"
b		0.350	0.400	0.470
D		4.850	5.000	5.150
D1		4.675	4.750	5.000
D2		3.700	4.210	4.300
e			1.270 BSC	
E		5.850	6.000	6.150
E1		5.675	5.750	6.000
E2		3.380	3.480	3.760
E4		2.480	2.580	2.680
L		0.550	0.800	0.900
R			0.200 REF	
R1			0.100 REF	
R2		0.150	0.200	0.250

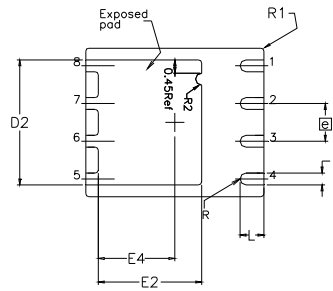

BOTTOM VIEW

For more information on board mounting, including footprint and stencil recommendation, please refer to application note AN-1136: <http://www.irf.com/technical-info/appnotes/an-1136.pdf>
 For more information on package inspection techniques, please refer to application note AN-1154: <http://www.irf.com/technical-info/appnotes/an-1154.pdf>

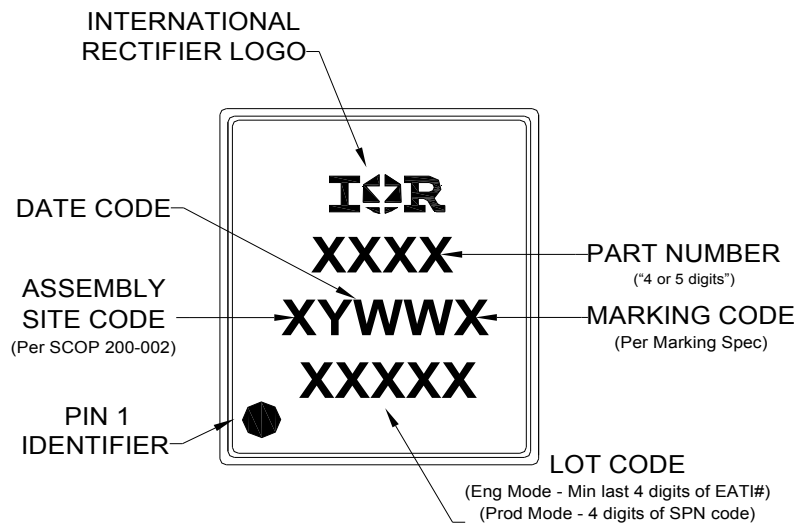
PQFN 5x6 Outline "B" Part Marking

Note: For the most current drawing please refer to IR website at <http://www.irf.com/package/>

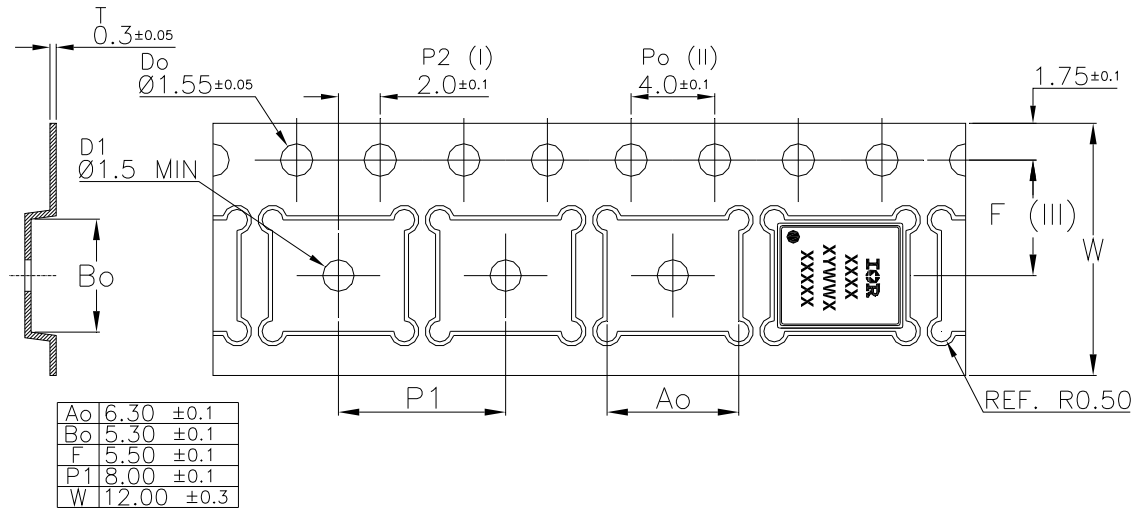
PQFN 5x6 Outline "B" Tape and Reel

Note: For the most current drawing please refer to IR website at <http://www.irf.com/package/>

Qualification Information[†]

Qualification Level	Industrial [†] (per JEDEC JESD47F ^{††} guidelines)	
Moisture Sensitivity Level	PQFN 5mm x 6mm	MSL1 (per JEDEC J-STD-020D ^{††})
RoHS Compliant	Yes	

† Qualification standards can be found at International Rectifier's web site: <http://www.irf.com/product-info/reliability/>

†† Applicable version of JEDEC standard at the time of product release.

Notes:

- ① Repetitive rating; pulse width limited by max. junction temperature.
- ② Starting $T_J = 25^\circ\text{C}$, $L = 0.107\text{mH}$, $R_G = 50\Omega$, $I_{AS} = 50\text{A}$.
- ③ Pulse width $\leq 400\mu\text{s}$; duty cycle $\leq 2\%$.
- ④ R_θ is measured at T_J of approximately 90°C .
- ⑤ When mounted on 1 inch square PCB (FR-4). Please refer to AN-994 for more details:
<http://www.irf.com/technical-info/appnotes/an-994.pdf>
- ⑥ Calculated continuous current based on maximum allowable junction temperature. Package is limited to 100A by production test capability.

Revision History

Date	Comments
5/13/2013	<ul style="list-style-type: none"> • Updated package 3D drawing, on page 1. • Updated current rating based on max rating not limited by package, on pages 1 and 2.
08/07/13	<ul style="list-style-type: none"> • Added "Fast/RFET™" above part number on page1

X-ON Electronics

Largest Supplier of Electrical and Electronic Components

Click to view similar products for [MOSFET](#) category:

Click to view products by [Infineon](#) manufacturer:

Other Similar products are found below :

[614233C](#) [648584F](#) [D2003UK](#) [705463DB](#) [MCH6422-TL-E](#) [FW231A-TL-E](#) [APT5010JFLL](#) [NTNS3A92PZT5G](#) [IRF100S201](#) [JANTX2N5237](#)
[2SK2464-TL-E](#) [2SK3818-DL-E](#) [FCA20N60_F109](#) [FDZ595PZ](#) [STD6600NT4G](#) [FQD4P40TM_AM002](#) [FSS804-TL-E](#) [FW217A-TL-2W](#)
[APT10050JVFR](#) [2SJ277-DL-E](#) [2SK1691-DL-E](#) [2SK2545\(Q,T\)](#) [D1014UK](#) [D2294UK](#) [405094E](#) [423220D](#) [MCH6646-TL-E](#) [TPCC8103,L1Q\(CM](#)
[IRF3710](#) [367-8430-0972-503](#) [VN1206L](#) [424134F](#) [026935X](#) [051075F](#) [SBVS138LT1G](#) [614234A](#) [715780A](#) [NTNS3166NZT5G](#) [751625C](#) [873612G](#)
[IPS70R2K0CEAKMA1](#) [APT8015JVFR](#) [APT50M85JVR](#) [APT5010JVFR](#) [APT12031JFLL](#) [APT12040JVR](#) [NTE6400](#) [NVC3S5A51PLZT1G](#)
[JANTX2N6796U](#) [JANTX2N6784U](#)