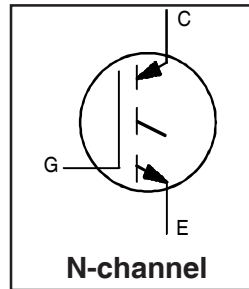


# IRG4BC20W-SPbF

INSULATED GATE BIPOLAR TRANSISTOR

## Features

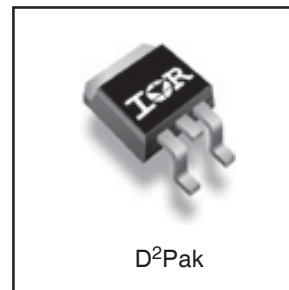
- Designed expressly for Switch-Mode Power Supply and PFC (power factor correction) applications
- Industry-benchmark switching losses improve efficiency of all power supply topologies
- 50% reduction of E<sub>off</sub> parameter
- Low IGBT conduction losses
- Latest-generation IGBT design and construction offers tighter parameters distribution, exceptional reliability
- Lead-Free



$V_{CES} = 600V$
$V_{CE(on)} \text{ typ.} = 2.16V$
@ $V_{GE} = 15V, I_C = 6.5A$

## Benefits

- Lower switching losses allow more cost-effective operation than power MOSFETs up to 150kHz ("hard switched" mode)
- Of particular benefit to single-ended converters and boost PFC topologies 150W and higher
- Low conduction losses and minimal minority-carrier recombination make these an excellent option for resonant mode switching as well (up to >>300kHz)



## Absolute Maximum Ratings

	Parameter	Max.	Units
$V_{CES}$	Collector-to-Emitter Breakdown Voltage	600	V
$I_C @ T_C = 25^\circ C$	Continuous Collector Current	13	A
$I_C @ T_C = 100^\circ C$	Continuous Collector Current	6.5	
$I_{CM}$	Pulsed Collector Current ①	52	
$I_{LM}$	Clamped Inductive Load Current ②	52	
$V_{GE}$	Gate-to-Emitter Voltage	$\pm 20$	V
$E_{ARV}$	Reverse Voltage Avalanche Energy ③	200	mJ
$P_D @ T_C = 25^\circ C$	Maximum Power Dissipation	60	W
$P_D @ T_C = 100^\circ C$	Maximum Power Dissipation	24	
$T_J$ $T_{STG}$	Operating Junction and Storage Temperature Range	-55 to + 150	°C
	Soldering Temperature, for 10 seconds	300 (0.063 in. (1.6mm) from case )	

## Thermal Resistance

	Parameter	Typ.	Max.	Units
$R_{\theta JC}$	Junction-to-Case	—	2.1	°C/W
$R_{\theta CS}$	Case-to-Sink, Flat, Greased Surface	0.5	—	
$R_{\theta JA}$	Junction-to-Ambient, typical socket mount	—	40	
Wt	Weight	1.44	—	g (oz)

## Electrical Characteristics @ $T_J = 25^\circ\text{C}$ (unless otherwise specified)

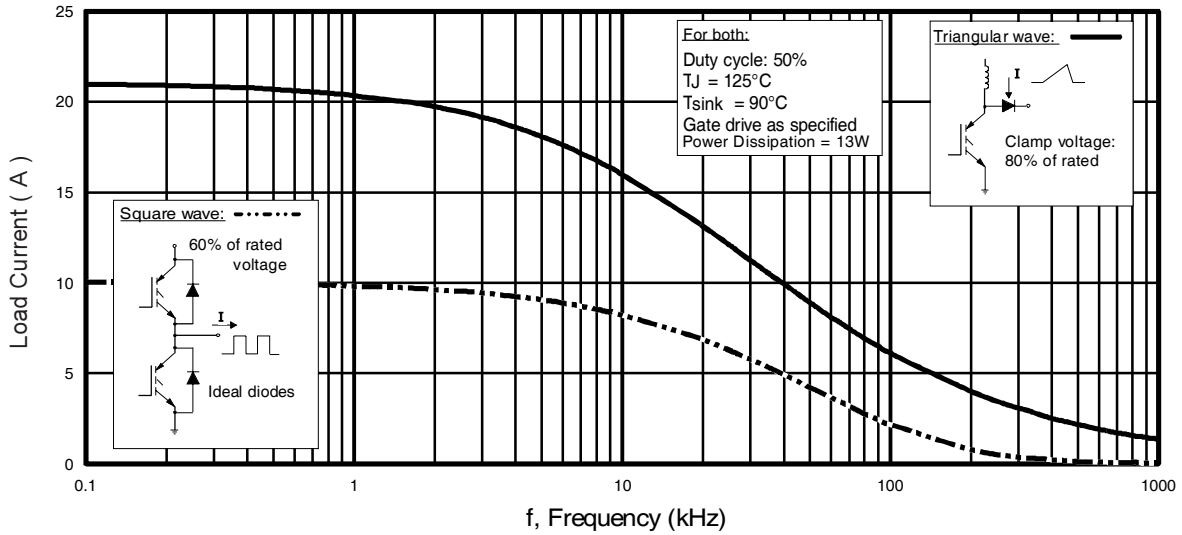
	Parameter	Min.	Typ.	Max.	Units	Conditions
$V_{(BR)CES}$	Collector-to-Emitter Breakdown Voltage	600	—	—	V	$V_{GE} = 0V, I_C = 250\mu A$
$V_{(BR)ECS}$	Emitter-to-Collector Breakdown Voltage ④	18	—	—	V	$V_{GE} = 0V, I_C = 1.0A$
$\Delta V_{(BR)CES}/\Delta T_J$	Temperature Coeff. of Breakdown Voltage	—	0.48	—	V/°C	$V_{GE} = 0V, I_C = 1.0mA$
$V_{CE(ON)}$	Collector-to-Emitter Saturation Voltage	—	2.16	2.6	V	$I_C = 6.5A, V_{GE} = 15V$ See Fig.2, 5
		—	2.55	—		
		—	2.05	—		
$V_{GE(th)}$	Gate Threshold Voltage	3.0	—	6.0		$I_C = 6.5A, T_J = 150^\circ\text{C}$ $V_{CE} = V_{GE}, I_C = 250\mu A$
$\Delta V_{GE(th)}/\Delta T_J$	Temperature Coeff. of Threshold Voltage	—	-8.8	—	mV/°C	$V_{CE} = V_{GE}, I_C = 250\mu A$
$g_{fe}$	Forward Transconductance ⑤	5.5	8.3	—	S	$V_{CE} = 100V, I_C = 6.5A$
$I_{CES}$	Zero Gate Voltage Collector Current	—	—	250	$\mu A$	$V_{GE} = 0V, V_{CE} = 600V$
		—	—	2.0		$V_{GE} = 0V, V_{CE} = 10V, T_J = 25^\circ\text{C}$
		—	—	1000		$V_{GE} = 0V, V_{CE} = 600V, T_J = 150^\circ\text{C}$
$I_{GES}$	Gate-to-Emitter Leakage Current	—	—	$\pm 100$	nA	$V_{GE} = \pm 20V$

## Switching Characteristics @ $T_J = 25^\circ\text{C}$ (unless otherwise specified)

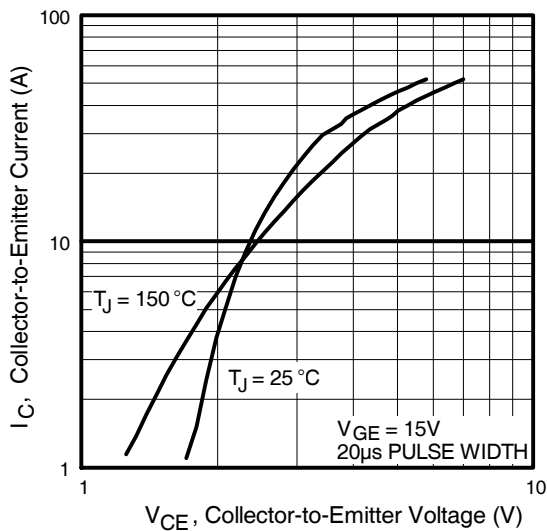
	Parameter	Min.	Typ.	Max.	Units	Conditions
$Q_g$	Total Gate Charge (turn-on)	—	26	38	nC	$I_C = 6.5A, V_{CC} = 400V, V_{GE} = 15V$ See Fig.8
$Q_{ge}$	Gate - Emitter Charge (turn-on)	—	3.7	5.5		
$Q_{gc}$	Gate - Collector Charge (turn-on)	—	10	15		
$t_{d(on)}$	Turn-On Delay Time	—	22	—	ns	$T_J = 25^\circ\text{C}$ $I_C = 6.5A, V_{CC} = 480V, V_{GE} = 15V, R_G = 50\Omega$ Energy losses include "tail" See Fig. 9, 10, 14
$t_r$	Rise Time	—	14	—		
$t_{d(off)}$	Turn-Off Delay Time	—	110	160		
$t_f$	Fall Time	—	64	96		
$E_{on}$	Turn-On Switching Loss	—	0.06	—	mJ	See Fig. 9, 10, 14
$E_{off}$	Turn-Off Switching Loss	—	0.08	—		
$E_{ts}$	Total Switching Loss	—	0.14	0.2		
$t_{d(on)}$	Turn-On Delay Time	—	21	—	ns	$T_J = 150^\circ\text{C}$ $I_C = 6.5A, V_{CC} = 480V, V_{GE} = 15V, R_G = 50\Omega$ Energy losses include "tail" See Fig. 10, 11, 14
$t_r$	Rise Time	—	15	—		
$t_{d(off)}$	Turn-Off Delay Time	—	150	—		
$t_f$	Fall Time	—	150	—		
$E_{ts}$	Total Switching Loss	—	0.34	—	mJ	
$L_E$	Internal Emitter Inductance	—	7.5	—	nH	Measured 5mm from package
$C_{ies}$	Input Capacitance	—	490	—	pF	$V_{GE} = 0V, V_{CC} = 30V, f = 1.0MHz$ See Fig. 7
$C_{oes}$	Output Capacitance	—	38	—		
$C_{res}$	Reverse Transfer Capacitance	—	8.8	—		

### Notes:

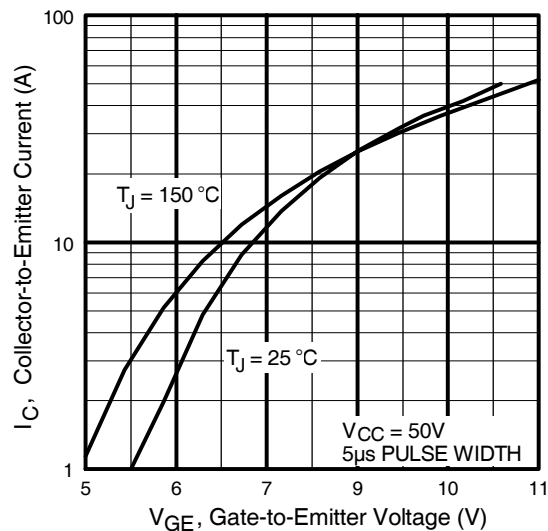
- ① Repetitive rating;  $V_{GE} = 20V$ , pulse width limited by max. junction temperature. (See Fig. 13b)
- ②  $V_{CC} = 80\%(V_{CES}), V_{GE} = 20V, L = 10\mu H, R_G = 50\Omega$ , (See Fig. 13a)
- ③ Repetitive rating; pulse width limited by maximum junction temperature.
- ④ Pulse width  $\leq 80\mu s$ ; duty factor  $\leq 0.1\%$ .
- ⑤ Pulse width  $5.0\mu s$ , single shot.



**Fig. 1** - Typical Load Current vs. Frequency  
(Load Current =  $I_{RMS}$  of fundamental)

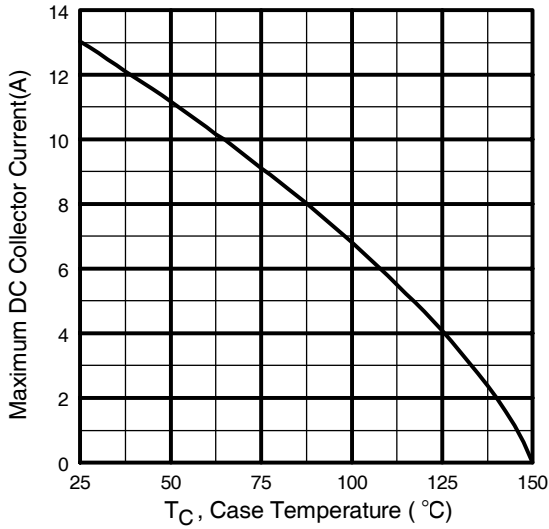


**Fig. 2** - Typical Output Characteristics

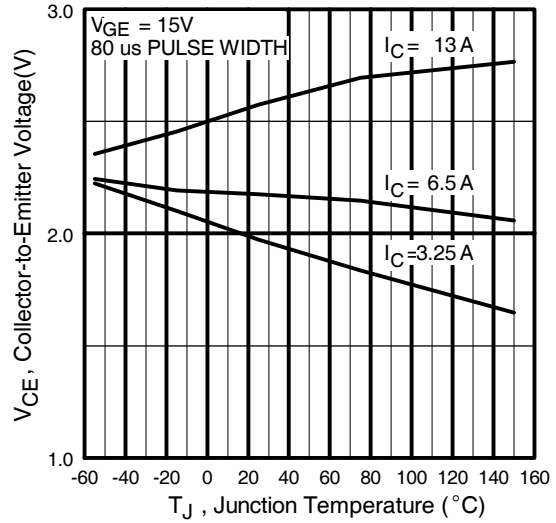


**Fig. 3** - Typical Transfer Characteristics

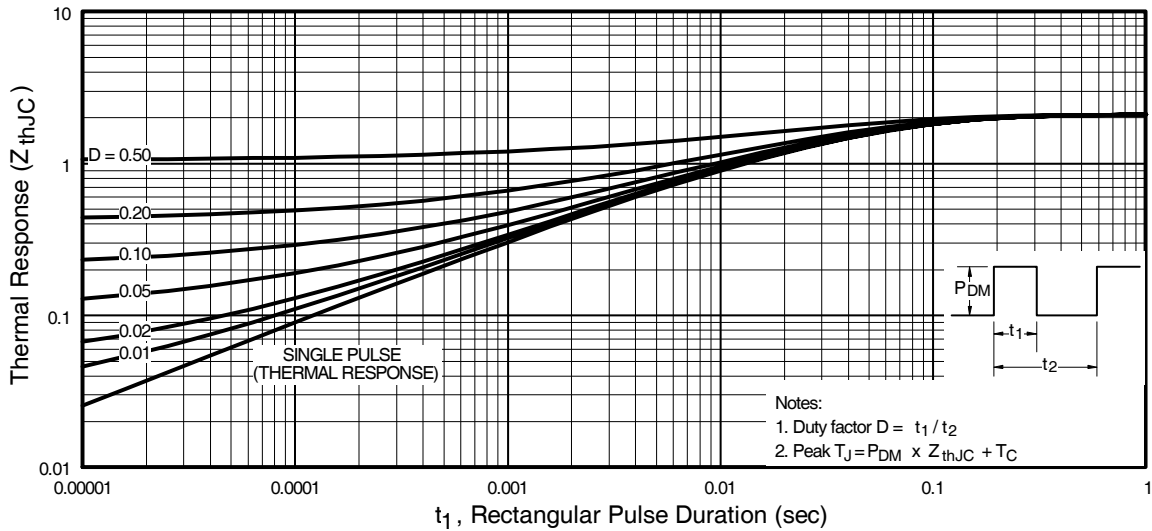
# IRG4BC20W-SPbF



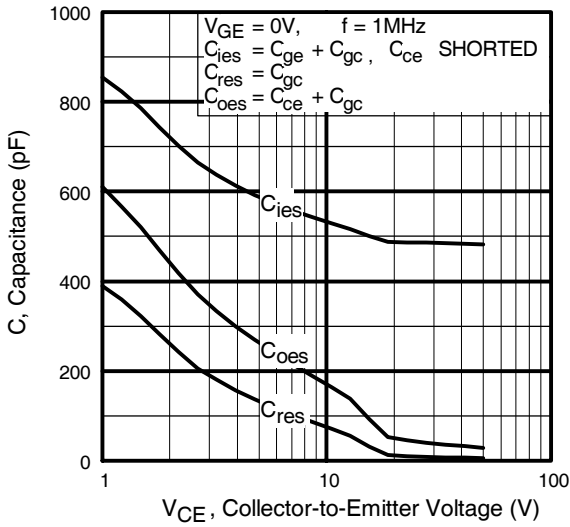
**Fig. 4** - Maximum Collector Current vs. Case Temperature



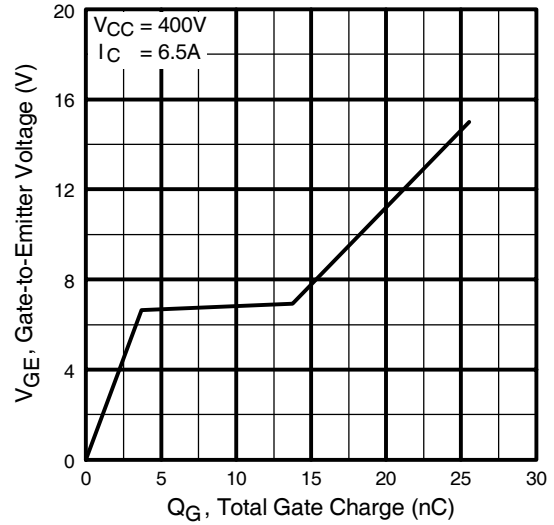
**Fig. 5** - Typical Collector-to-Emitter Voltage vs. Junction Temperature



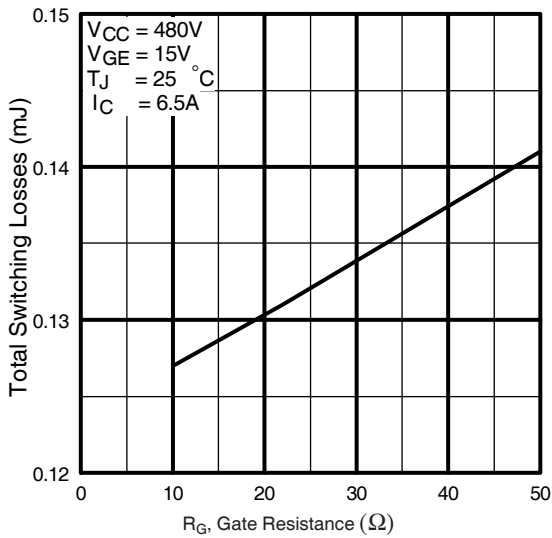
**Fig. 6** - Maximum Effective Transient Thermal Impedance, Junction-to-Case



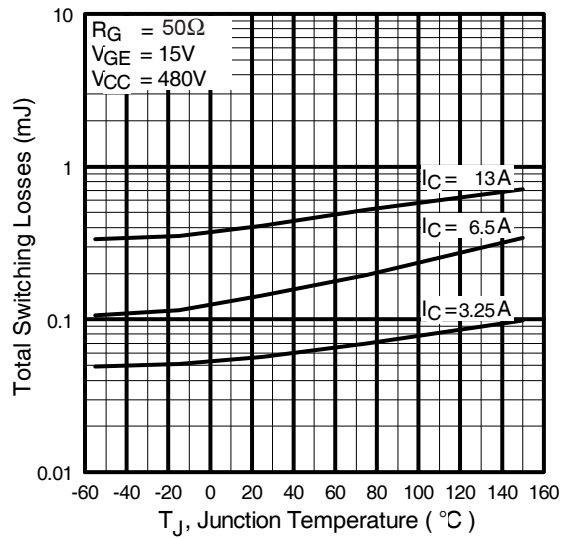
**Fig. 7** - Typical Capacitance vs. Collector-to-Emitter Voltage



**Fig. 8** - Typical Gate Charge vs. Gate-to-Emitter Voltage

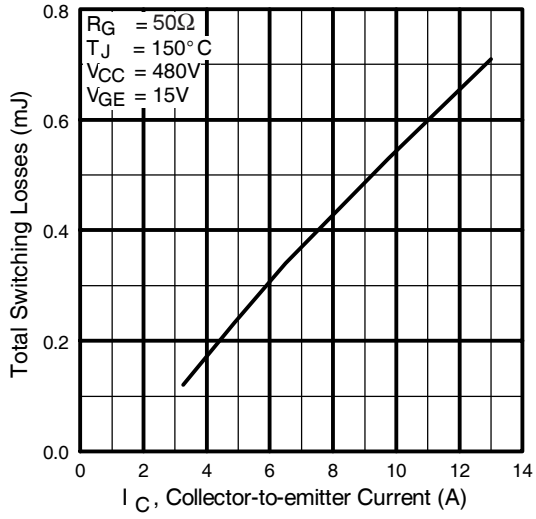


**Fig. 9** - Typical Switching Losses vs. Gate Resistance

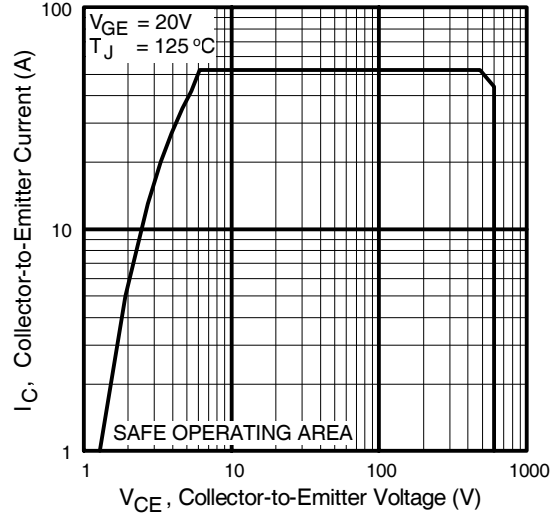


**Fig. 10** - Typical Switching Losses vs. Junction Temperature

# IRG4BC20W-SPbF



**Fig. 11** - Typical Switching Losses vs. Collector-to-Emitter Current

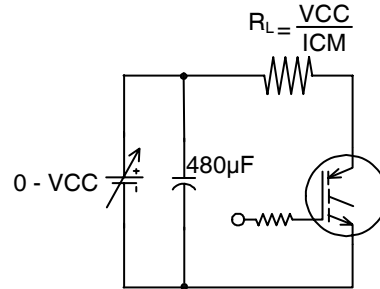


**Fig. 12** - Turn-Off SOA



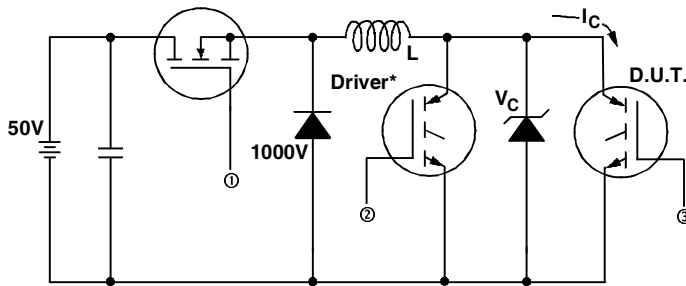
\* Driver same type as D.U.T.;  $V_c = 80\%$  of  $V_{ce(max)}$   
 \* Note: Due to the 50V power supply, pulse width and inductor will increase to obtain rated  $I_d$ .

**Fig. 13a** - Clamped Inductive Load Test Circuit



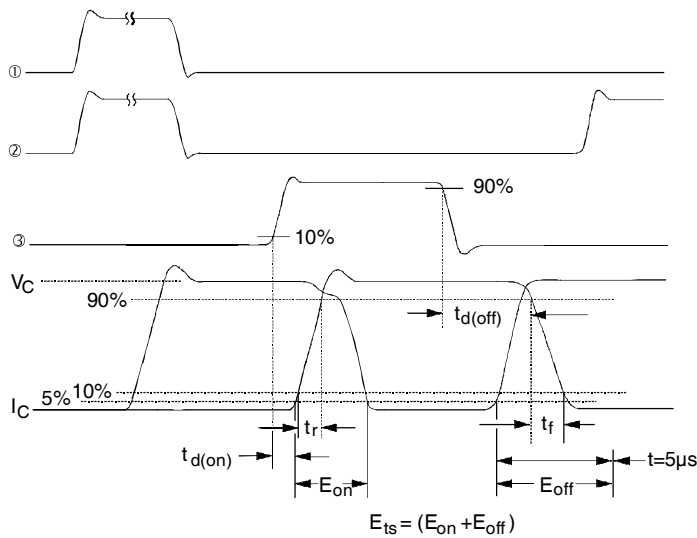
Pulsed Collector Current Test Circuit

**Fig. 13b** - Pulsed Collector Current Test Circuit



**Fig. 14a** - Switching Loss Test Circuit

\* Driver same type as D.U.T.,  $V_C = 480V$



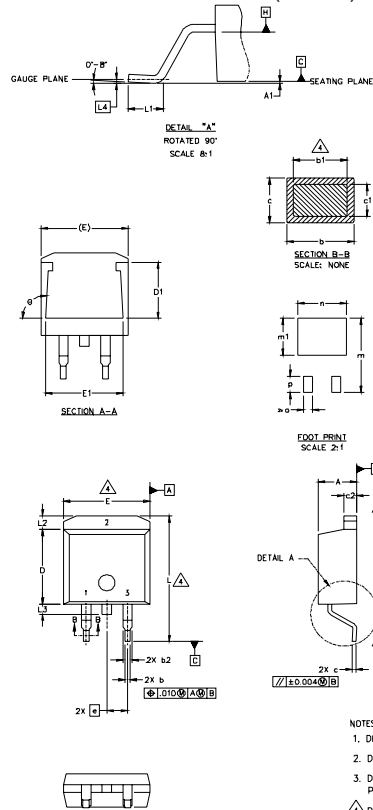
**Fig. 14b** - Switching Loss Waveforms

# IRG4BC20W-SPbF



## D<sup>2</sup>Pak Package Outline

Dimensions are shown in millimeters (inches)



SYMBOL	DIMENSIONS				NOTES
	MILLIMETERS		INCHES		
	MIN.	MAX.	MIN.	MAX.	
A	4.06	4.83	.160	.190	
A1		0.127		.005	
b	0.51	0.99	.020	.039	4
b1	0.51	0.89	.020	.035	
b2	1.14	1.40	.045	.055	4
c	0.43	0.63	.017	.025	
c1	0.38	0.74	.015	.029	3
c2	1.14	1.40	.045	.055	
D	8.51	9.65	.335	.380	3
D1	5.33		.210		
E	9.65	10.67	.380	.420	3
E1	6.22		.245		
e	2.54	BSC	.100	BSC	
L	14.61	15.88	.575	.625	
L1	1.78	2.79	.070	.110	
L2		1.65		.065	
L3	1.27	1.78	.050	.070	
L4	0.25	BSC	.010	BSC	
m	17.78		.700		
m1	8.89		.350		
n	11.43		.450		
o	2.08		.082		
p	3.81		.150		
theta	90°	93°	90°	93°	

### LEAD ASSIGNMENTS

HEXFET	IGBTs_CoPACK	DIODES
1.- GATE	1.- GATE	1.- ANODE *
2.- DRAIN	2.- COLLECTOR	2.- CATHODE
3.- SOURCE	3.- EMITTER	3.- ANODE

\* PART DEPENDENT.

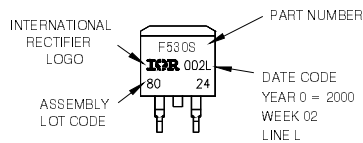
### NOTES:

1. DIMENSIONING AND TOLERANCING PER ASME Y14.5M-1994
2. DIMENSIONS ARE SHOWN IN MILLIMETERS [INCHES].
3. DIMENSION D & E DO NOT INCLUDE MOLD FLASH. MOLD FLASH SHALL NOT EXCEED 0.127 [0.005"] PER SIDE. THESE DIMENSIONS ARE MEASURED AT THE OUTMOST EXTREMES OF THE PLASTIC BODY.
4. DIMENSION b1 AND c1 APPLY TO BASE METAL ONLY.
5. CONTROLLING DIMENSION: INCH.

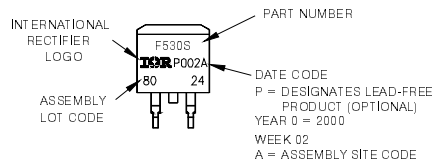
## D<sup>2</sup>Pak Part Marking Information

EXAMPLE: THIS IS AN IRF530S WITH LOT CODE 8024 ASSEMBLED ON WW 02, 2000 IN THE ASSEMBLY LINE 'L'

Note: 'P' in assembly line position indicates 'Lead-Free'



**OR**

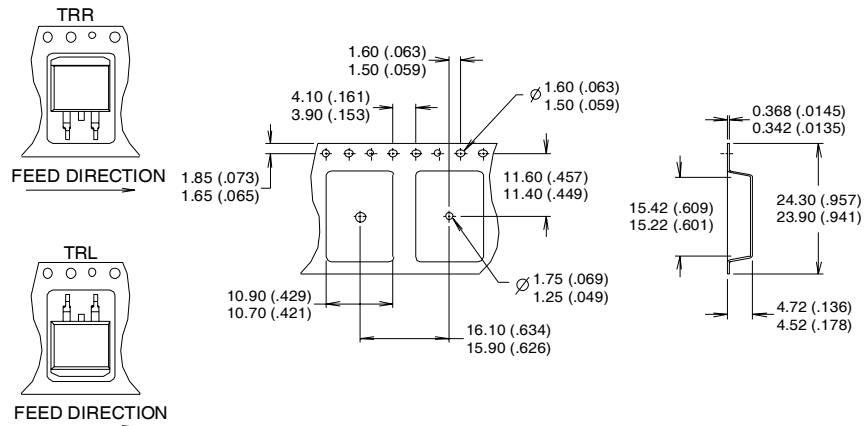


Note: For the most current drawing please refer to IR website at <http://www.irf.com/package/>



## D<sup>2</sup>Pak Tape & Reel Information

Dimensions are shown in millimeters (inches)



- NOTES:
1. CONFORMS TO EIA-418.
  2. CONTROLLING DIMENSION: MILLIMETER.
  3. DIMENSION MEASURED @ HUB.
  4. INCLUDES FLANGE DISTORTION @ OUTER EDGE.

Data and specifications subject to change without notice.  
 This product has been designed and qualified for the Industrial market.  
 Qualification Standards can be found on IR's Web site.

# X-ON Electronics

Largest Supplier of Electrical and Electronic Components

*Click to view similar products for [IGBT Transistors](#) category:*

*Click to view products by [Infineon](#) manufacturer:*

Other Similar products are found below :

[748152A](#) [FGH60T65SHD\\_F155](#) [APT100GT60B2RG](#) [APT13GP120BG](#) [APT15GN120BDQ1G](#) [APT15GP90BDQ1G](#) [APT20GN60BG](#)  
[APT20GT60BRDQ1G](#) [APT25GN120B2DQ2G](#) [APT35GA90BD15](#) [APT36GA60BD15](#) [APT40GP60B2DQ2G](#) [APT40GP90B2DQ2G](#)  
[APT50GN120B2G](#) [APT50GT60BRG](#) [APT64GA90B2D30](#) [APT70GR120J](#) [NGTB10N60FG](#) [NGTB30N60L2WG](#) [IGP30N60H3XKSA1](#)  
[IGW40N60H3FKSA1](#) [IXGK50N60B NRND](#) [STGB15H60DF](#) [STGFW20V60DF](#) [STGFW30V60DF](#) [STGFW40V60F](#) [STGWA25H120DF2](#)  
[FGB3236\\_F085](#) [APT13GP120BDQ1G](#) [APT25GN120BG](#) [APT25GR120S](#) [APT30GN60BDQ2G](#) [APT30GN60BG](#) [APT30GP60BG](#)  
[APT30GS60BRDQ2G](#) [APT30N60BC6](#) [APT35GP120JDQ2](#) [APT36GA60B](#) [APT45GR65B2DU30](#) [APT50GP60B2DQ2G](#) [APT68GA60B](#)  
[APT70GR65B](#) [APT70GR65B2SCD30](#) [GT50JR22\(STA1ES\)](#) [IDW40E65D2](#) [SGB15N120ATMA1](#) [NGTB50N60L2WG](#) [STGB10H60DF](#)  
[STGB20V60F](#) [STGB40V60F](#)