

Display Elektronik GmbH

DATA SHEET

TFT- MODULE

DEM 800480B TMH-PW-N

7,0" TFT

06.01.2011

Revise Records

Rev.	Date	Contents	Written	Approved
0	06.05.2010	Preliminary Specification	AJ	MH
1	06.01.2011	1. Add ROHS Compliance Description 2. Modify contrast ratio	AJ	MH

Special Notes

Note1.	
Note2.	
Note3.	
Note4.	
Note5.	

Contents

1. General Description and Features	4
1.1 Features	4
1.2 LCD Module	4
2. Mechanical Information	4
3. Electrical Specifications	5
3.1 Absolute Max. Ratings	5
3.2 AC Timing Characteristic of The LCD	6
3.3 LVDS Switching Characteristics	8
3.4 Back-Light Unit	10
4. Optical Characteristics	10
4.1 Optical characteristic of the LCD	10
5. I/O Terminal	12
5.1 Pin Assignment	12
5.2 Back Light Unit	13
5.3 Block Diagram	13
6. Display Color and Input Data	14
7. Reliability Condition	15
8. Dimensional Outlines	16

1. General Description and Features

DEM 800480B TMH-PW-N is a transmissive type color active matrix TFT (Thin Film Transistor) liquid crystal display (LCD) that uses amorphous silicon TFT as a switching device. This model is composed of a TFT-LCD module, a receiver circuit and a back-light unit. Graphics and texts can be displayed on a WVGA 800 (W) x RGB x 480 (H) dots (16:9 aspect ratio) with 262,144 colors. The following table described the features of DEM 800480B TMH-PW-N.

1.1 Features

- Transmissive and back-light with 30 LEDs are available.
- TN (Twisted Nematic) mode.
- LVDS Receiver 18 bit Interface.
- ROHS Compliance

1.2 LCD Module

Item	Specification	Unit
Screen Size	7.0 inches	Diagonal
Display Resolution	800 (H) x 480 (V)	Pixel
Active Area	152.4 (H) x 91.44 (V)	mm
Outline Dimension	166.6 (H) x 109.4 (V) x 10.0 (T)	mm
Display Mode	Normally white mode/ Transmissive	--
Pixel Arrangement	R,G,B Vertical Stripe	--
Pixel Size	0.1905 x 0.1905	mm
Surface Treatment	Anti-Glare and Hard Coating(3H)	
Display Color	262K	--
Viewing Direction	6 o'clock	--
Input Interface	LVDS Receiver 18 bit Interface	--

2. Mechanical Information

Item		Min.	Typ.	Max.	Unit	Note
Module Size	Horizontal (H)	--	166.6	--	mm	
	Vertical (V)	--	109.4	--	mm	
	Thickness (T)	--	10.0	--	mm	(1)
Weight		--	(165)	--	g	--

Note (1) Not Include Component. Refer to the Outline Dimension Drawing as attached.

3. Electrical Specifications

3.1 Absolute Max. Ratings

3.1.1 Absolute Ratings of Environment

If the operating condition exceeds the following absolute maximum ratings, the TFT LCD module may be damaged permanently.

($T_a=25\pm 2^\circ\text{C}$, $V_{SS}=\text{GND}=0$)

Item	Symbol	Min.	Max.	Unit	Note
Storage temperature	T_{STG}	-30	80	$^\circ\text{C}$	(1)
Operating temperature	T_{OPR}	-20	70	$^\circ\text{C}$	(1,2,3)

Note (1) 95 % RH Max. ($40^\circ\text{C} \geq T_a$). Maximum wet-bulb temperature at 39°C or less. ($T_a > 40^\circ\text{C}$) No condensation.

Note (2) In case of below 0° , the response time of liquid crystal (LC) becomes slower and the color of panel becomes darker than normal one. Level of retardation depends on temperature, because of LC's character

Note (3) Only operation is guaranteed at operating temperature. Contrast, response time, another display quality are evaluated at $+25^\circ\text{C}$.

3.1.2 Electrical Absolute Maximum Ratings

3.1.2.1 TFT-LCD Module

($V_{SS}=\text{GND}=0$)

Parameter	Symbol	Min.	Max.	Unit	Remark
Power supply voltage	V_{CC}	-0.3	4.0	V	
input voltage	V_I	-0.3	$V_{CC}+0.3$	V	--

3.1.2.2 Backlight Unit

($V_{SS}=\text{GND}=0$)

Parameter	Symbol	Min.	Max.	Unit	Remark
Current of Backlight Unit	IB	--	250	mA	
Voltage of Backlight Unit	VB	--	15	V	

3.1.3 DC Electrical Characteristics of the TFT LCD

(Ta=25±2°C, V_{SS}=GND=0)

Item	Symbol	Min.	Typ.	Max.	Unit	Remark
Power supply	VCC	3.0	3.3	3.6	V	
Input Voltage for logic	Differential Input High Threshold VTH			+100	mA	
	Differential Input Low Threshold VTL	-100			mA	
Power Supply current	ICC	-	(215)	TBD	mA	Note 1

Note1: fv =60Hz , Ta=25°C , Display pattern : Black pattern

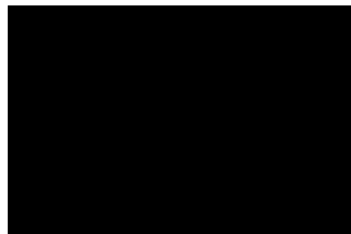

3.2 AC Timing Characteristic of The LCD

3.2.1 Timing Condition (DE only mode)

Signal	Parameter	Symbol	Min.	Typ.	Max.	Unit.	Remark
DCLK	CLK frequency	F _{CPH}	29.4	33.26	42.48	MHz	
	CLK period	T _{CPH}	-	30.06	-	ns	
	CLK pulse duty	T _{CWH}	40	50	60	%	
DE	DE period	T _{DEH} +T _{DEL}	1000	1056	1200	T _{CPH}	
	DE pulse width	T _{DEH}	-	800	-	T _{CPH}	
	DE frame blanking	T _{DEB}	10	45	110	T _{DEH} +T _{DEL}	
	DE frame width	T _{DE}	-	480	-	T _{DEH} +T _{DEL}	
	DE setup time	T _{esu}	6	-	-	ns	
Data	Data setup time	T _{dsu}	6	-	-	ns	
	Data hold time	T _{dhd}	6	-	-	ns	

3.2.2 Timing Characteristic

3.2.2.1 DE and RGB Data Input Timing

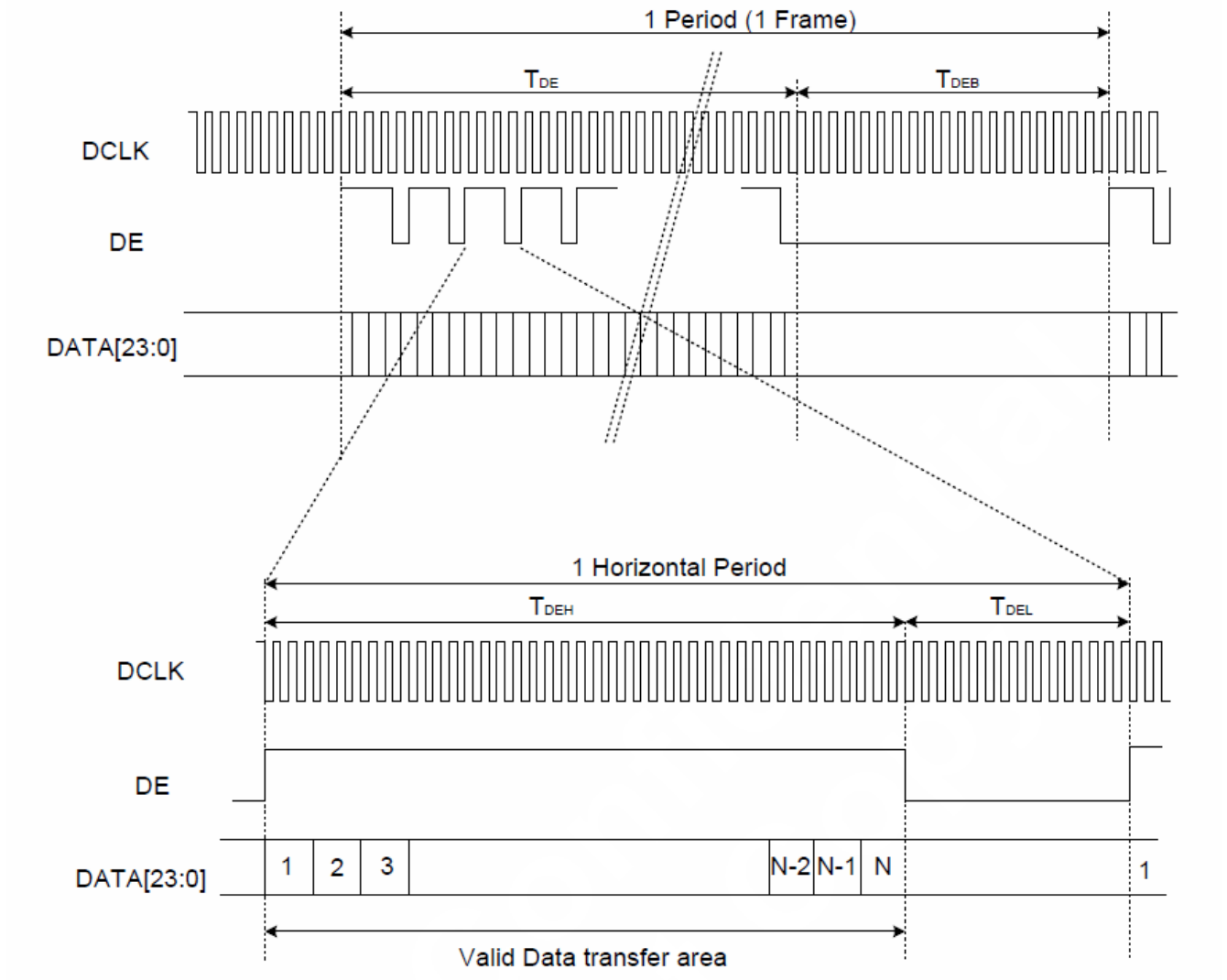

3.2.2.2 Clock and Data input waveforms

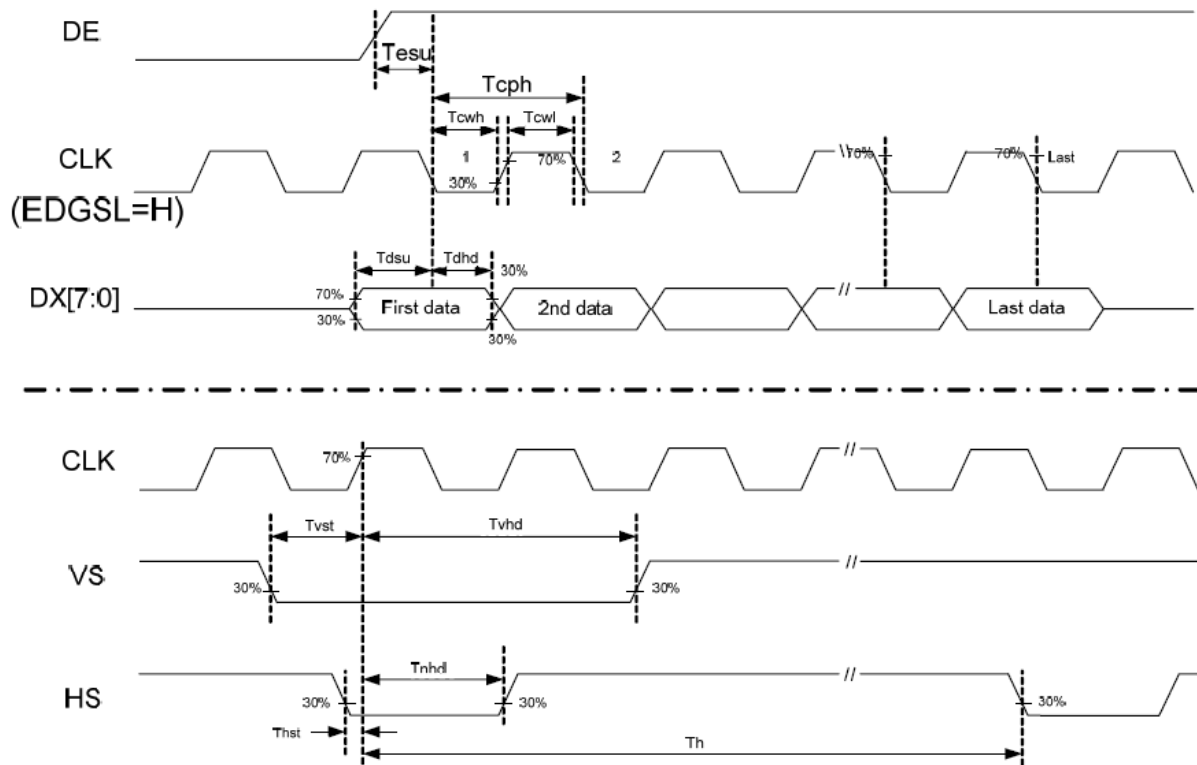

3.3 LVDS Switching Characteristics

3.3.1 LVDS Timing Condition

Symbol	Parameter	Min.	Typ.	Max.	Unit.	Note
tRCP	CLK OUT Period	VCC = 3.0 - 3.6V	11.76	T	50.0	ns
		VCC = 2.5 - 3.6V	14.28	T	50.0	ns
tRCH	CLK OUT High Time	-	4T/7	-	ns	
tRCL	CLK OUT Low Time	-	3T/7	-	ns	
tRCD	RCLK +/- to CLK OUT Delay	-	5T/7	-	ns	
tRS	TTL Data Setup to CLK OUT	0.35T-0.3	-	-	ns	
tRH	TTL Data Hold from CLK OUT	0.45T-1.6	-	-	ns	
tTLH	TTL Low to High Transition Time	-	2.0	3.0	ns	
tTHL	TTL High to Low Transition Time	-	1.8	3.0	ns	
tRIP1	Input Data Position0 (T = 11.76ns)	-0.4	0.0	0.4	ns	
tRIP0	Input Data Position1 (T = 11.76ns)	T/7-0.4	T/7	T/7+0.4	ns	
tRIP6	Input Data Position2 (T = 11.76ns)	2T/7-0.4	2T/7	2T/7+0.4	ns	
tRIP5	Input Data Position3 (T = 11.76ns)	3T/7-0.4	3T/7	3T/7+0.4	ns	
tRIP4	Input Data Position4 (T = 11.76ns)	4T/7-0.4	4T/7	4T/7+0.4	ns	
tRIP3	Input Data Position5 (T = 11.76ns)	5T/7-0.4	5T/7	5T/7+0.4	ns	
tRIP2	Input Data Position6 (T = 11.76ns)	6T/7-0.4	6T/7	6T/7+0.4	ns	
tRPLL	Phase Lock Loop Set			10.0	ms	

3.3.2 LVDS AC Timing

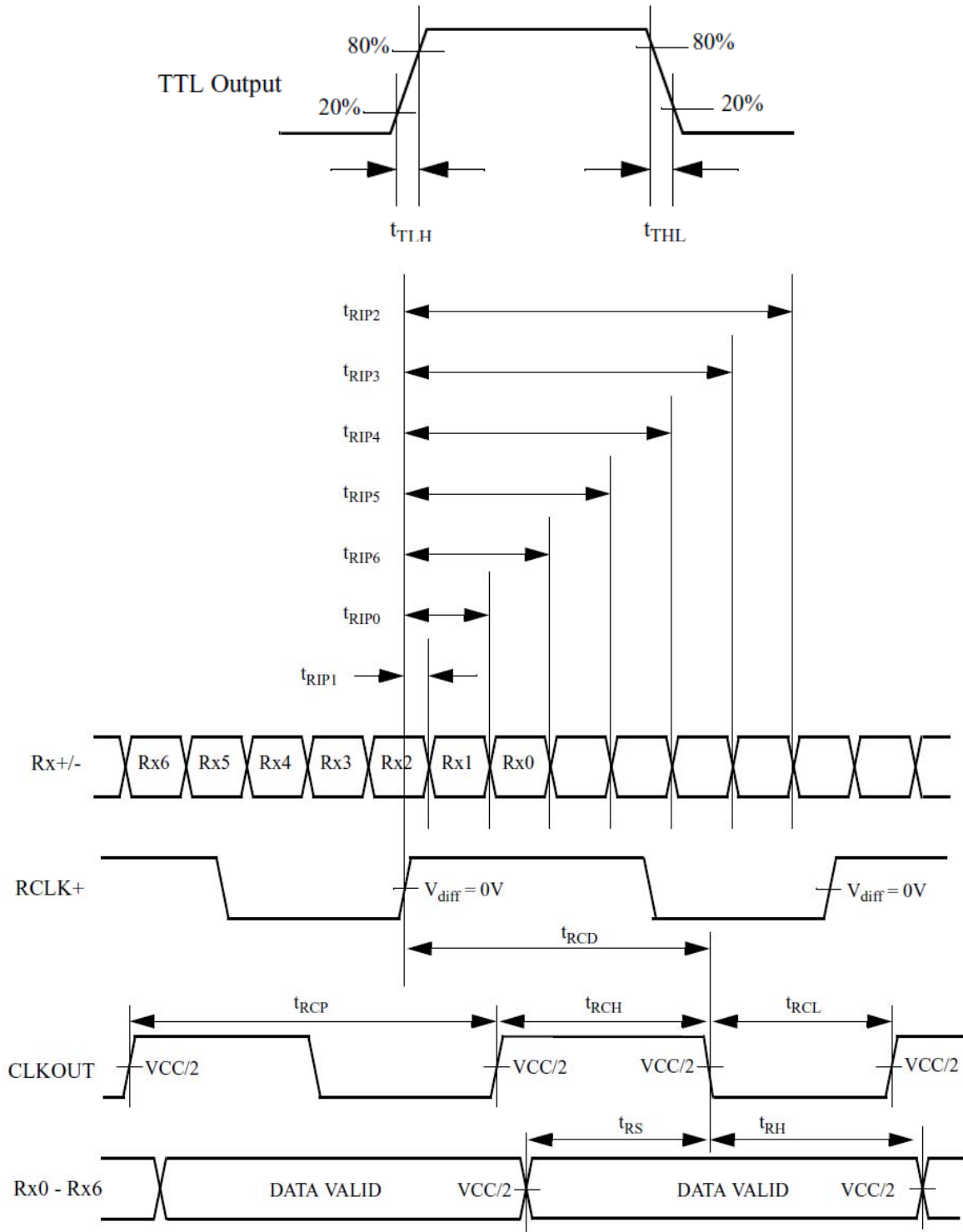

3.4 Back-Light Unit

The Back-light system is an edge-lighting type with 30 white LED (Light Emitting Diode)s. The characteristics of 30 white LEDs are shown in the following tables.

(Ta= Room Temp)

Characteristics	Symbol	Min.	Typ.	Max.	Unit	Note
Forward Voltage	VB	(9.3)	(9.9)	(10.5)	V	
Forward Current	IB	-	200	-	mA	(1)
Power Consumption	P _{BL}	-	1980	-	mW	(2)
LED Life time	-	(40000)	-	-	hr	(3)

Note (1) LEDs in 3 series x 10 parallel type.

(2) Where IB = 200mA, VB = 9.9, P_{BL} = VB × IB

(3) The environmental conducted under ambient air flow ,at Ta=25±2°C, 60%RH±5%

4. Optical Characteristics

4.1 Optical characteristic of the LCD

The following items are measured under stable conditions. The optical characteristics should be measured in a dark room or equivalent state with the methods.

Measuring equipment: BM-7A

Item	Symbol	Condition	Min	Type	Max	Unit	Note
Brightness	B		(450)	(500)	--	cd/m ²	
Response time	T _r	θ=0°	-	5	10	ms	.
	T _f		--	15	20	ms	
Contrast ratio	CR	At optimized viewing angle	(350)	(400)	--	--	
Color Gamut	NTSC %	--	--	TBD	--	%	
Luminance Uniformity	ΔL		70	75		%	
Color Chromaticity (CIE 1931)	White	W _x	(0.270)	(0.320)	(0.370)	--	BM-7A
		W _y	(0.300)	(0.350)	(0.400)		
Viewing Angle (6H)	Hor.	θ _R	CR≥10	55	65	--	Degree
		θ _L		55	65	--	
	Ver.	θ _U		45	55	--	
		θ _D		55	65	--	

a. Test equipment setup

After stabilizing and leaving the panel alone shall be warmed up for the stable operation of LCM, the measurement should be executed. Measurement should be executed in a stable, windless, and dark room. Optical specifications are measured by Topcon BM-7(fast) with a viewing angle of 2° at a distance of 50cm and normal direction.

b. Definition of response time: Tr and Tf

The response time is defined as the following figure and shall be measured by switching the input signal for "black" and "white".

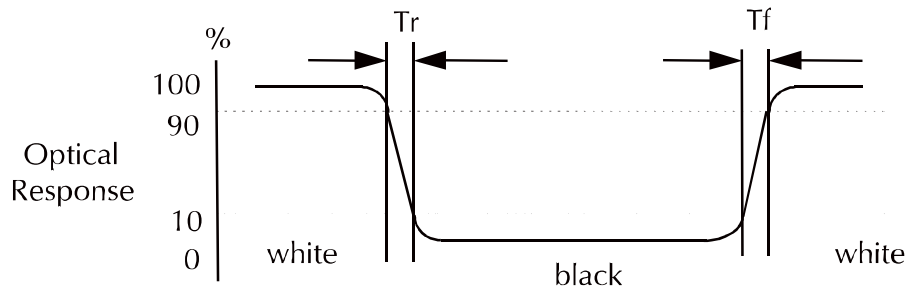

c. Definition of contrast ratio:

Brightness measured when LCD is at "white state"

$$\text{Contrast Ratio (CR)} = \frac{\text{Brightness measured when LCD is at "white state"}}{\text{Brightness measured when LCD is at "black state"}}$$

d. Measured at the center area of the panel when all the input terminals of LCD panel are electrically opened.

e. View Angle

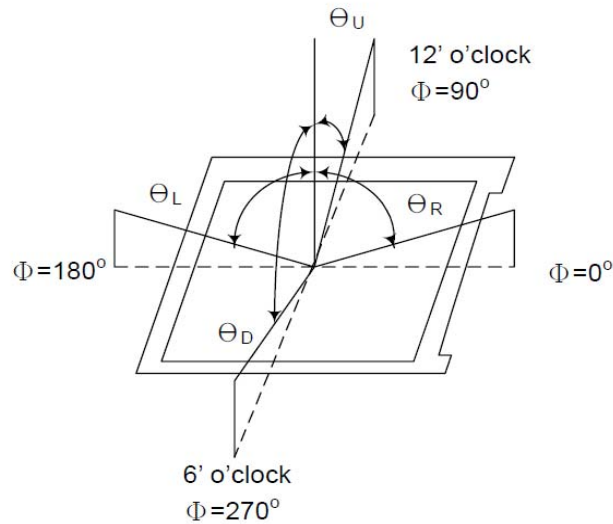

f. Definition of Luminance of White: Luminance of white at the center points

Light Source of Back-Light Unit	LED Type
---------------------------------	----------

g. Definition of White Uniformity

$$\text{White Uniformity} = \frac{\text{Min. luminance of white among 9-points}}{\text{Max. luminance of white among 9-points}} \times 100\%$$

h. The definition of Color Gamut -Color Chromaticity CIE 1931

Color coordinate of white & red, green, blue at center point.

Color Gamut : NTSC(%) = (RGB Triangle Area / NTSC Triangle Area) x 100

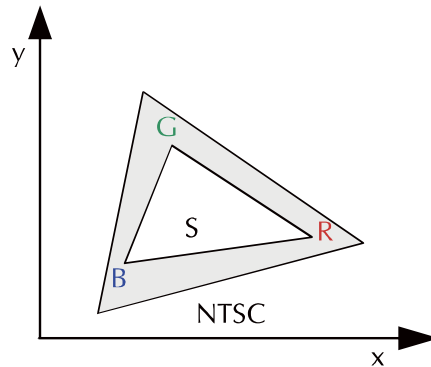

5. I/O Terminal

5.1 Pin Assignment (connector part No: MSB24013P20A or equivalent.)

Pin No.	Symbol	I/O	Function	Remark
1	VCC	P	Power Supply +3.3V	
2	VCC	P	Power Supply +3.3V	
3	VSS	P	Ground	
4	VSS	P	Ground	
5	RIN0-	I	Negative LVDS differential data input	
6	RIN0+	I	Positive LVDS differential data input	
7	VSS	P	Ground	
8	RIN1-	I	Negative LVDS differential data input	
9	RIN1+	I	Positive LVDS differential data input	
10	VSS	P	Ground	
11	RIN2-	I	Negative LVDS differential data input	
12	RIN2+	I	Positive LVDS differential data input	
13	VSS	P	Ground	
14	RCLK-	I	Negative LVDS differential clock input	
15	RCLK+	I	Positive LVDS differential clock input	
16	VSS	P	Ground	
17	NC	-	NO Connect	
18	NC	-	NO Connect	
19	VSS	P	Ground	
20	VSS	P	Ground	

I: Input, P: Power

Notes:

- 1) NC Pin must be retained; this pin can't contact VSS or other signal.
- 2) VSS Pin must ground contact, can not be floating.

5.2 Back Light Unit (Connector Part No: JST:BHSR-02VS-01(N) or equivalent.)

Pin No.	Symbol	Function	Remark
1	LEDA	Power Supply for LED backlight	RED
2	LEDK	GND for LED backlight	BLACK

5.3 Block Diagram

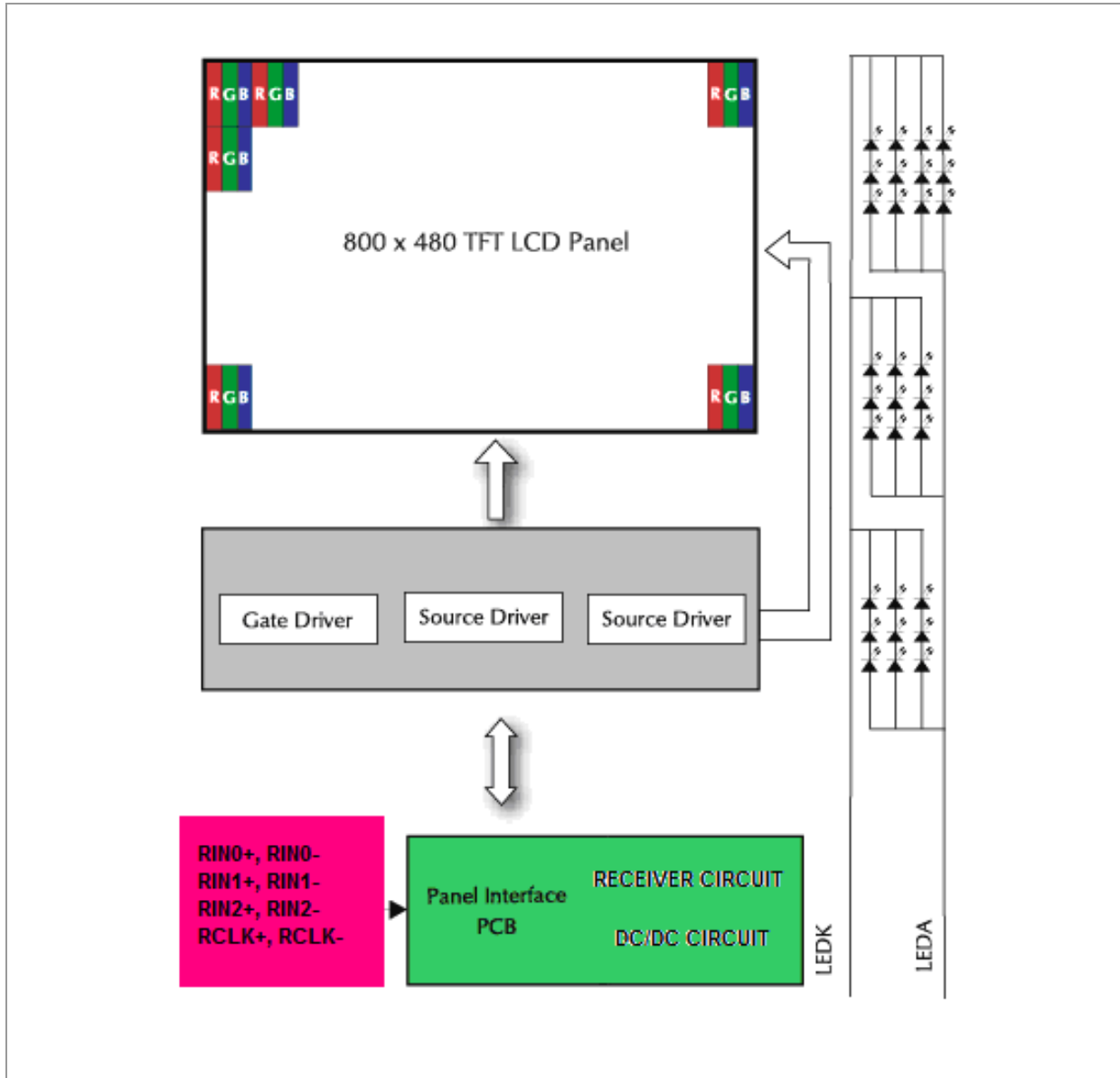

6. Displayed Color and Input Data

	Color & Gray Scale	Data Signal																	
		R5	R4	R3	R2	R1	R0	G5	G4	G3	G2	G1	G0	B5	B4	B3	B2	B1	B0
Basic Color	Black	0	0	0	0	0	0	0	0	0	0	0	0	0	0	0	0	0	0
	Red(0)	1	1	1	1	1	1	0	0	0	0	0	0	0	0	0	0	0	0
	Green(0)	0	0	0	0	0	0	1	1	1	1	1	1	0	0	0	0	0	0
	Blue(0)	0	0	0	0	0	0	0	0	0	0	0	0	1	1	1	1	1	1
	Cyan	0	0	0	0	0	0	1	1	1	1	1	1	1	1	1	1	1	1
	Magenta	1	1	1	1	1	1	0	0	0	0	0	0	1	1	1	1	1	1
	Yellow	1	1	1	1	1	1	1	1	1	1	1	1	0	0	0	0	0	0
	White	1	1	1	1	1	1	1	1	1	1	1	1	1	1	1	1	1	1
Red	Black	0	0	0	0	0	0	0	0	0	0	0	0	0	0	0	0	0	0
	Red(62)	0	0	0	0	0	1	0	0	0	0	0	0	0	0	0	0	0	0
	Red(61)	0	0	0	0	1	0	0	0	0	0	0	0	0	0	0	0	0	0
	:	:	:	:	:	:	:	:	:	:	:	:	:	:	:	:	:	:	:
	Red(31)	0	1	1	1	1	1	0	0	0	0	0	0	0	0	0	0	0	0
	:	:	:	:	:	:	:	:	:	:	:	:	:	:	:	:	:	:	:
	Red(1)	1	1	1	1	1	0	0	0	0	0	0	0	0	0	0	0	0	0
	Red(0)	1	1	1	1	1	1	0	0	0	0	0	0	0	0	0	0	0	0
Green	Black	0	0	0	0	0	0	0	0	0	0	0	0	0	0	0	0	0	0
	Green(62)	0	0	0	0	0	0	0	0	0	0	0	1	0	0	0	0	0	0
	Green(61)	0	0	0	0	0	0	0	0	0	0	1	0	0	0	0	0	0	0
	:	:	:	:	:	:	:	:	:	:	:	:	:	:	:	:	:	:	:
	Green(31)	0	0	0	0	0	0	0	1	1	1	1	0	0	0	0	0	0	0
	:	:	:	:	:	:	:	:	:	:	:	:	:	:	:	:	:	:	:
	Green(1)	0	0	0	0	0	0	1	1	1	1	1	0	0	0	0	0	0	0
	Green(0)	0	0	0	0	0	0	1	1	1	1	1	1	0	0	0	0	0	0
Blue	Black	0	0	0	0	0	0	0	0	0	0	0	0	0	0	0	0	0	0
	Blue(62)	0	0	0	0	0	0	0	0	0	0	0	0	0	0	0	0	0	1
	Blue(61)	0	0	0	0	0	0	0	0	0	0	0	0	0	0	0	0	1	0
	:	:	:	:	:	:	:	:	:	:	:	:	:	:	:	:	:	:	:
	Blue(31)	0	0	0	0	0	0	0	0	0	0	0	0	0	1	1	1	1	1
	:	:	:	:	:	:	:	:	:	:	:	:	:	:	:	:	:	:	:
	Blue(1)	0	0	0	0	0	0	0	0	0	0	0	0	1	1	1	1	1	0
	Blue(0)	0	0	0	0	0	0	0	0	0	0	0	0	1	1	1	1	1	1

0 : Low level voltage, 1 :High level voltage

Each basic color can be displayed in 64 gray scales from 6 bit data signals. With the combination of total 18 bit data signals, the 262,144-color display can be achieved on the screen.

7. Reliability Condition

No change on display and in operation under the following test condition.

Condition: Unless otherwise specified, tests will be conducted under the following condition.

Temperature: 20±5°C.

Humidity: 65±5%RH.

Tests will be not conducted under functioning state.

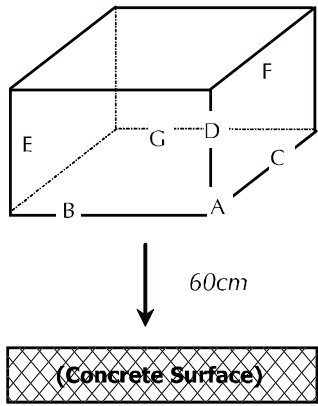
No.	Parameter	Condition	Notes
1	High Temperature Operating	70°C±2°C, 240hrs (Operation state).	
2	Low Temperature Operating	-20°C±2°C, 240hrs (Operation state).	1
3	High Temperature Storage	80°C±2°C, 240hrs.	2
4	Low Temperature Storage	-30°C±2°C, 240hrs.	1,2
5	High Temperature and High Humidity Operation Test	60°C±2°C, 90%, 240hrs.	1,2
6	Vibration Test	Total fixed amplitude: 1.5mm. Vibration Frequency: 10~55Hz. One cycle 60 seconds to 3 direction of X, Y, Z each 15 minutes.	3
7.	Drop Test	To be measured after dropping from 60cm high on the concrete surface in packing state.  <i>Dropping method corner dropping:</i> <i>A corner: Once edge dropping.</i> <i>B, C, D edge: Once face dropping.</i> <i>E, F, G face: Once.</i>	

- Notes:
1. No dew condensation to be observed.
 2. The function test shall be conducted after 4 hours storage at the normal temperature and humidity after removed from the test chamber.
 3. Vibration test will be conducted to the product itself without putting I in a container.

8. Dimensional Outlines

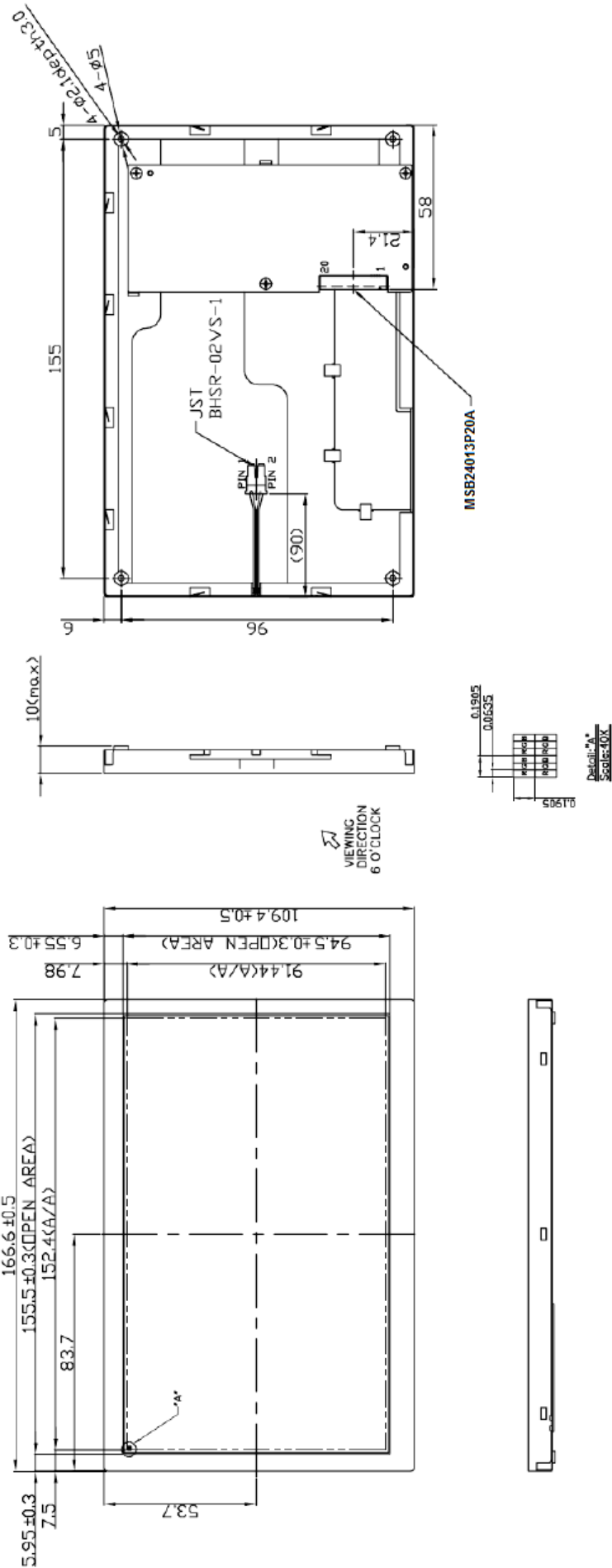

X-ON Electronics

Largest Supplier of Electrical and Electronic Components

Click to view similar products for [TFT Displays & Accessories](#) category:

Click to view products by [Display Elektronik](#) manufacturer:

Other Similar products are found below :

[OAI-80038AA-2013-A](#) [HDA430T-3G1H](#) [EA CARREDIPTFT02](#) [NL6448BC20-21D](#) [NB7W-KBA04](#) [NB-ATT01](#) [NB5Q-ATT01](#) [NB5Q-KBA04](#) [NB-CN001](#) [NL12880BC20-05](#) [NL8060BC26-35C](#) [NL8060BC26-35F](#) [TCG104SVLQAPNN-AN20](#) [OAI-80038AA-2008-A](#) [315-U004B15300](#) [UMSH-8596MD-34T \(REV D\)](#) [98-0003-3490-8](#) [1044278](#) [1029309](#) [1060549](#) [DE 127-TU-30/7,5](#) [DE 128-TU-20/7,5](#) [EP-LK007TFTPCAP](#) [FR7.0A00](#) [RC2002A-TIG-CSX](#) [NL6448BC2021C](#) [TX17D01VM2EAB](#) [TX14D23VM5BAA](#)
[TCG121WXLRXVNNANX35](#) [EIC-LCD-1080P](#) [T272480C07VR01](#) [1060632](#) [TCG070WVLPAAANN-AN50](#) [TCG035QVLPDANN-GN50](#)
[1060630](#) [RFE430V-AIW-DNG](#) [T-55619GD065J-LW-ABN](#) [NHD-1.8-128160EF-SSXN-FT](#) [TCG104SVLPEANN-AN30](#) [NL6448BC33-70](#)
[NL192108BC18-06F](#) [NLB150XG02L-01](#) [NL6448BC20-30D](#) [NL10276BC16-06](#) [NL192108AC10-01D](#) [NL6448AC18-08F](#) [NL6448BC20-30F](#)
[NL12880BC20-05BD](#) [NL12880BC20-05D](#) [NL8060BC26-35BA](#)