

Long distance proximity sensor

■ Features

- Long sensing distance
(1.5 to 2 times longer sensing distance guaranteed compared to existing models)
- Improved the noise resistance with dedicated IC
- Built-in surge protection, reverse polarity protection, overcurrent protection circuit
- Long life cycle and high reliability
- Red LED status indication
- Protection structure IP67(IEC standard)
- Replaceable for micro switches and limit switches
- Improved cable strain relief : More reliable flexural strength of sensor/cable connecting part



⚠ Please read "Caution for your safety" in operation manual before using.



■ Specifications

● DC 2-wire type

Model	PRDT12-4 □ O PRDT12-4 □ C PRDT12-4 □ O-V PRDT12-4 □ C-V PRDLT12-4 □ O PRDLT12-4 □ C PRDLT12-4 □ O-V PRDLT12-4 □ C-V PRDWT12-4 □ O PRDWT12-4 □ C PRDWT12-4 □ O-I PRDWT12-4 □ C-I PRDWT12-4 □ O-IV PRDWT12-4 □ C-IV	PRDT12-8 □ O PRDT12-8 □ C PRDT12-8 □ O-V PRDT12-8 □ C-V PRDLT12-8 □ O PRDLT12-8 □ C PRDLT12-8 □ O-V PRDLT12-8 □ C-V PRDWT12-8 □ O PRDWT12-8 □ C PRDWT12-8 □ O-I PRDWT12-8 □ C-I PRDWT12-8 □ O-IV PRDWT12-8 □ C-IV	PRDT18-7 □ O PRDT18-7 □ C PRDT18-7 □ O-V PRDT18-7 □ C-V PRDLT18-7 □ O PRDLT18-7 □ C PRDLT18-7 □ O-V PRDLT18-7 □ C-V PRDWT18-7 □ O PRDWT18-7 □ C PRDWT18-7 □ O-I PRDWT18-7 □ C-I PRDWT18-7 □ O-IV PRDWT18-7 □ C-IV PRDWLT18-7 □ O-IV PRDWLT18-7 □ C-IV	PRDT18-14 □ O PRDT18-14 □ C PRDT18-14 □ O-V PRDT18-14 □ C-V PRDLT18-14 □ O PRDLT18-14 □ C PRDLT18-14 □ O-V PRDLT18-14 □ C-V PRDWT18-14 □ O PRDWT18-14 □ C PRDWT18-14 □ O-I PRDWT18-14 □ C-I PRDWT18-14 □ O-IV PRDWT18-14 □ C-IV PRDWLT18-14 □ O-IV PRDWLT18-14 □ C-IV	PRDT30-15 □ O PRDT30-15 □ C PRDT30-15 □ O-V PRDT30-15 □ C-V PRDLT30-15 □ O PRDLT30-15 □ C PRDLT30-15 □ O-V PRDLT30-15 □ C-V PRDWT30-15 □ O PRDWT30-15 □ C PRDWT30-15 □ O-I PRDWT30-15 □ C-I PRDWT30-15 □ O-IV PRDWT30-15 □ C-IV	PRDT30-25 □ O PRDT30-25 □ C PRDT30-25 □ O-V PRDT30-25 □ C-V PRDLT30-25 □ O PRDLT30-25 □ C PRDLT30-25 □ O-V PRDLT30-25 □ C-V PRDWT30-25 □ O PRDWT30-25 □ C PRDWT30-25 □ O-I PRDWT30-25 □ C-I PRDWT30-25 □ O-IV PRDWT30-25 □ C-IV
Sensing distance	4mm	8mm	7mm	14mm	15mm	25mm
Hysteresis	Max. 10% of sensing distance					
Standard sensing target	12×12×1mm(Iron)	25×25×1mm (Iron)	20×20×1mm (Iron)	40×40×1mm (Iron)	45×45×1mm (Iron)	75×75×1mm (Iron)
Sensing distance	0 to 2.8mm	0 to 5.6mm	0 to 4.9mm	0 to 9.8mm	0 to 10.5mm	0 to 17.5mm
Power supply (Operating voltage)	12-24VDC (10-30VDC)					
Leakage current	Max. 0.6mA					
Response frequency ^{*1}	450Hz	400Hz	250Hz	200Hz	100Hz	
Residual voltage ^{*2}	Max. 3.5V(for non-polarity type, max. 5V)					
Affection by Temp.	Max. ±10% for sensing distance at ambient temperature 20°C					
Control output	2 to 100mA					
Insulation resistance	Min. 50MΩ(at 500VDC megger)					
Dielectric strength	1500VAC 50/60Hz for 1minute					
Vibration	1mm amplitude at frequency of 10 to 55Hz(for 1 min.) in each of X, Y, Z directions for 2 hours					
Shock	500m/s ² (approx. 50G) X, Y, Z directions for 3 times					
Indicator	Operation indicator(red LED)					
Environment	Ambient temperature: -25 to 70°C, Storage: -30 to 80°C Ambient humidity: 35 to 95%RH, Storage: 35 to 95%RH					
Protection circuit	Surge protection circuit, Reverse polarity protection circuit, Overcurrent protection circuit					
Material	Case/Nut: Nickel plated Brass, Washer: Nickel plated Iron, Sensing surface: Heat-resistant ABS, Standard cable(Black): Polyvinyl chloride(PVC), Oil resistant cable(Gray): Oil resistant Polyvinyl chloride(PVC)					
Cable	ø4, 2-wire, 2m (For cable type, 300mm, M12 connector), (AWG22, Core diameter: 0.08mm, Number of cores: 60, Insulator diameter: ø1.25) ø5, 2-wire, 2m					
Approval	CE					
Protection	IP67(IEC Standard)					
Unit weight	PRDT: Approx. 74g PRDLT: Approx. 94g PRDWT: Approx. 44g	PRDT: Approx. 72g PRDLT: Approx. 92g PRDWT: Approx. 42g	PRDT: Approx. 115g PRDLT: Approx. 145g PRDWT: Approx. 80g PRDWLT: Approx. 42g	PRDT: Approx. 110g PRDLT: Approx. 140g PRDWT: Approx. 75g PRDWLT: Approx. 105g	PRDT: Approx. 175g PRDLT: Approx. 215g PRDWT: Approx. 140g	PRDT: Approx. 180g PRDLT: Approx. 220g PRDWT: Approx. 145g

*1: The response frequency is the average value. The standard sensing target is used and the width is set as 2 times of the standard sensing target, 1/2 of the sensing distance for the distance.

*2: Before using non-polarity type, check the condition of connected device because residual voltage is 5V.

※ The '□' of model name is for power type. 'D' is 12-24VDC, 'X' is non-polarity 12-24VDC.

※ The last 'V' of model name is for the model with oil-resistance reinforced cable.

※ Environment resistance is rated at no freezing or condensation.

(A)	Photo electric sensor
(B)	Fiber optic sensor
(C)	Door/Area sensor
(D)	Proximity sensor
(E)	Pressure sensor
(F)	Rotary encoder
(G)	Connector/Socket
(H)	Temp. controller
(I)	SSR/Power controller
(J)	Counter
(K)	Timer
(L)	Panel meter
(M)	Tacho/Speed/Pulse meter
(N)	Display unit
(O)	Sensor controller
(P)	Switching mode power supply
(Q)	Stepper motor& Driver&Controller
(R)	Graphic/Logic panel
(S)	Field network device
(T)	Software
(U)	Other

PRD/PRDW Series

■ Specifications

● DC 3-wire type

Model	PRD12-4DN PRD12-4DP PRD12-4DN2 PRD12-4DP2 PRDL12-4DN PRDL12-4DP PRDL12-4DN2 PRDL12-4DP2 PRDW12-4DN PRDW12-4DP PRDW12-4DN2 PRDW12-4DP2 PRDW12-4DN-V PRDW12-4DP-V PRDWL12-4DN PRDWL12-4DP PRDWL12-4DN2 PRDWL12-4DP2	PRD12-8DN PRD12-8DP PRD12-8DN2 PRD12-8DP2 PRDL12-8DN PRDL12-8DP PRDL12-8DN2 PRDL12-8DP2 PRDW12-8DN PRDW12-8DP PRDW12-8DN2 PRDW12-8DP2 PRDW12-8DN-V PRDW12-8DP-V PRDWL12-8DN PRDWL12-8DP PRDWL12-8DN2 PRDWL12-8DP2	PRD18-7DN PRD18-7DP PRD18-7DN2 PRD18-7DP2 PRDL18-7DN PRDL18-7DP PRDL18-7DN2 PRDL18-7DP2 PRDW18-7DN PRDW18-7DP PRDW18-7DN2 PRDW18-7DP2 PRDW18-7DN-V PRDW18-7DP-V PRDWL18-7DN PRDWL18-7DP PRDWL18-7DN2 PRDWL18-7DP2	PRD18-14DN PRD18-14DP PRD18-14DN2 PRD18-14DP2 PRDL18-14DN PRDL18-14DP PRDL18-14DN2 PRDL18-14DP2 PRDW18-14DN PRDW18-14DP PRDW18-14DN2 PRDW18-14DP2 PRDW18-14DN-V PRDW18-14DP-V PRDWL18-14DN PRDWL18-14DP PRDWL18-14DN2 PRDWL18-14DP2	PRD30-15DN PRD30-15DP PRD30-15DN2 PRD30-15DP2 PRDL30-15DN PRDL30-15DP PRDL30-15DN2 PRDL30-15DP2 PRDW30-15DN PRDW30-15DP PRDW30-15DN2 PRDW30-15DP2 PRDW30-15DN-V PRDW30-15DP-V PRDWL30-15DN PRDWL30-15DP PRDWL30-15DN2 PRDWL30-15DP2	PRD30-25DN PRD30-25DP PRD30-25DN2 PRD30-25DP2 PRDL30-25DN PRDL30-25DP PRDL30-25DN2 PRDL30-25DP2 PRDW30-25DN PRDW30-25DP PRDW30-25DN2 PRDW30-25DP2 PRDW30-25DN-V PRDW30-25DP-V PRDWL30-25DN PRDWL30-25DP PRDWL30-25DN2 PRDWL30-25DP2
Sensing distance	4mm	8mm	7mm	14mm	15mm	25mm
Hysteresis	Max. 10% of sensing distance					
Standard sensing target	12×12×1mm(Iron)	25×25×1mm(Iron)	20×20×1mm (Iron)	40×40×1mm (Iron)	45×45×1mm (Iron)	75×75×1mm (Iron)
Sensing distance	0 to 2.8mm	0 to 5.6mm	0 to 4.9mm	0 to 9.8mm	0 to 10.5mm	0 to 17.5mm
Power supply (Operating voltage)	12-24VDC (10-30VDC)					
Current consumption	Max. 10mA					
Response frequency*1	500Hz	400Hz	300Hz	200Hz	100HZ	100Hz
Residual voltage	Max. 1.5V					
Affection by Temp.	Max. ±10% for sensing distance at ambient temperature 20°C					
Control output	200mA					
Insulation resistance	Min. 50MΩ(at 500VDC megger)					
Dielectric strength	1500VAC 50/60Hz for 1minute					
Vibration	1mm amplitude at frequency of 10 to 55Hz(for 1 min.) in each of X, Y, Z directions for 2 hours					
Shock	500m/s ² (approx. 50G) X, Y, Z directions for 3 times					
Indicator	Operation indicator(red LED)					
Environ- ment	Ambient temperature	-25 to 70°C, Storage: -30 to 80°C				
	Ambient humidity	35 to 95%RH, Storage: 35 to 95%RH				
Protection circuit	Surge protection circuit, Reverse polarity protection circuit, Overcurrent protection circuit					
Protection	IP67(IEC Standard)					
Material	Case/Nut: Nickel plated Brass, Washer: Nickel plated Iron, Sensing surface: Heat-resistant ABS, Standard cable(Black): Polyvinyl chloride(PVC), Oil resistant cable(Gray): Oil resistant Polyvinyl chloride(PVC)					
Cable	ø4, 3-wire, 2m		ø5, 3-wire, 2m			
	(For cable type, 300mm, M12 connector), (AWG22, Core diameter: 0.08mm, Number of cores: 60, Insulator diameter: ø1.25)					
Approval	CE					
Unit weight	PRD: Approx. 74g PRDL: Approx. 94g PRDW: Approx. 44g PRDWL: Approx. 64g	PRD: Approx. 72g PRDL: Approx. 92g PRDW: Approx. 42g PRDWL: Approx. 62g	PRD: Approx. 115g PRDL: Approx. 145g PRDW: Approx. 80g PRDWL: Approx. 110g	PRD: Approx. 110g PRDL: Approx. 140g PRDW: Approx. 75g PRDWL: Approx. 105g	PRD: Approx. 175g PRDL: Approx. 215g PRDW: Approx. 140g PRDWL: Approx. 180g	PRD: Approx. 180g PRDL: Approx. 220g PRDW: Approx. 145g PRDWL: Approx. 185g

*1: The response frequency is the average value. The standard sensing target is used and the width is set as 2 times of the standard sensing target, 1/2 of the sensing distance for the distance.

※The last 'V' of model name is for the model with oil-resistance reinforced cable.

※Environment resistance is rated at no freezing or condensation.

■ Dimensions

(unit: mm)

● PRD(T)12-4D□

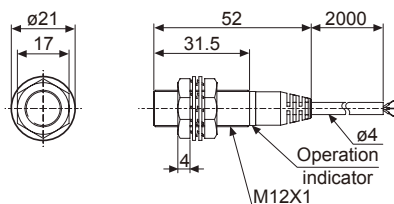

● PRD(T)12-8D□

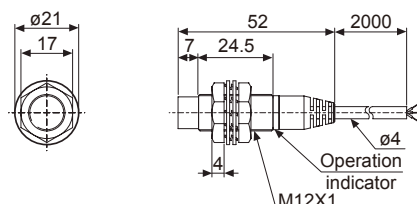

Long Distance Type

■ Dimensions

(unit: mm)

● PRDL(T)12-4D

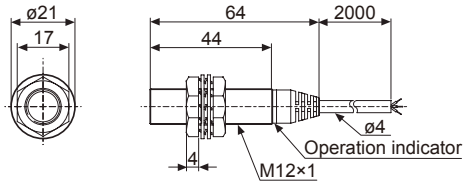

● PRDL(T)12-8D

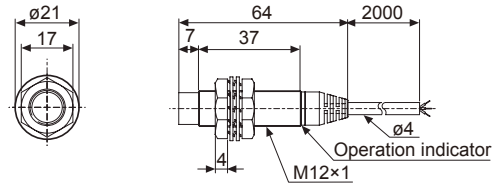

● PRD(T)18-7D

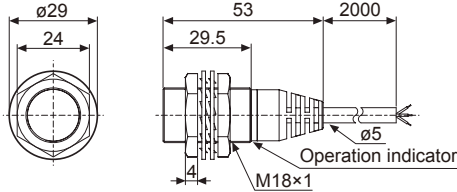

● PRD(T)18-14D

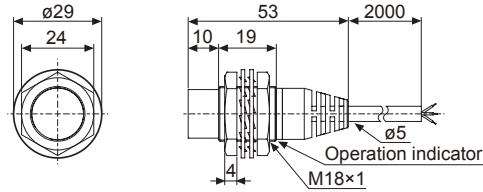

● PRDL(T)18-7D

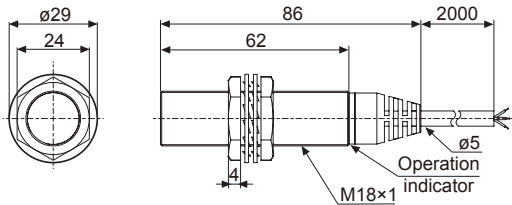

● PRDL(T)18-14D

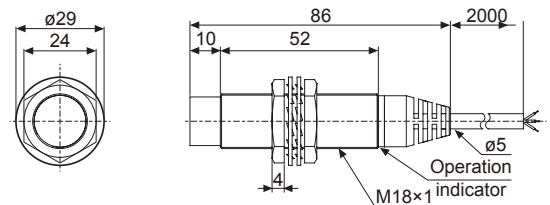

● PRD(T)30-15D

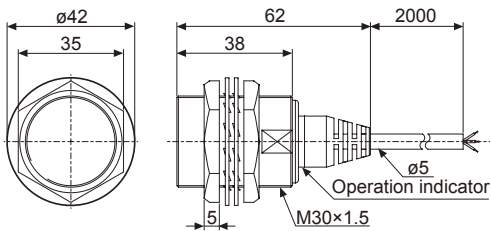

● PRD(T)30-25D

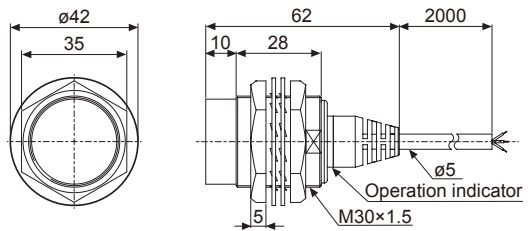

● PRDL(T)30-15D

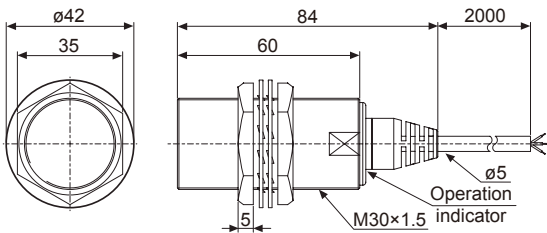

● PRDL(T)30-25D

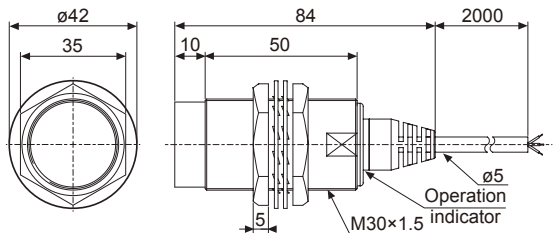

● PRDW(T)12-4D

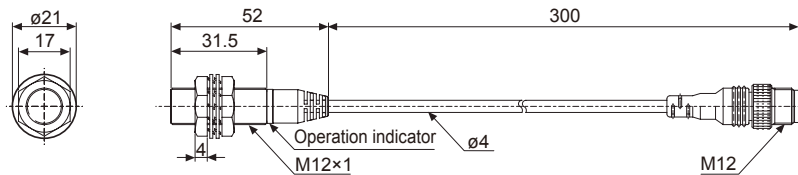

● PRDW(T)12-8D

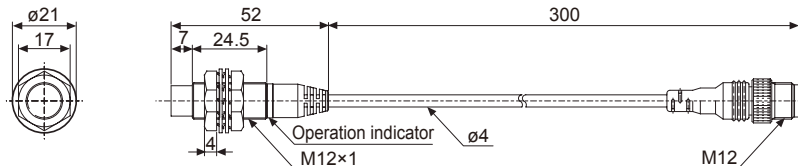

(A) Photo electric sensor

(B) Fiber optic sensor

(C) Door/Area sensor

(D) Proximity sensor

(E) Pressure sensor

(F) Rotary encoder

(G) Connector/Socket

(H) Temp. controller

(I) SSR/ Power controller

(J) Counter

(K) Timer

(L) Panel meter

(M) Tacho/ Speed/ Pulse meter

(N) Display unit

(O) Sensor controller

(P) Switching mode power supply

(Q) Stepper motor & Driver&Controller

(R) Graphic/ Logic panel

(S) Field network device

(T) Software

(U) Other

PRD/PRDW Series

■ Dimensions

(unit: mm)

● PRDWL12-4D

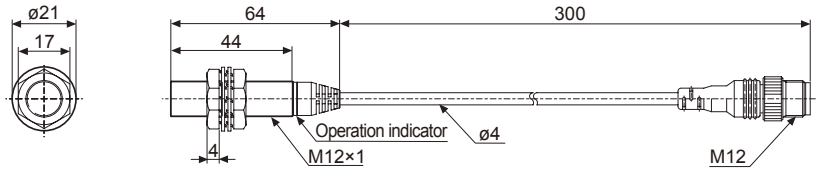

● PRDWL12-8D

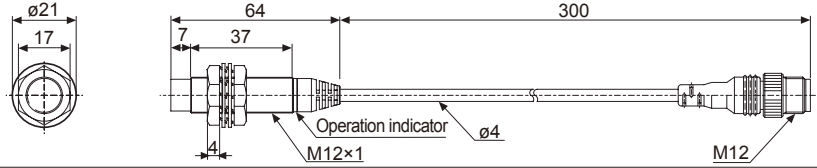

● PRDW(T)18-7D

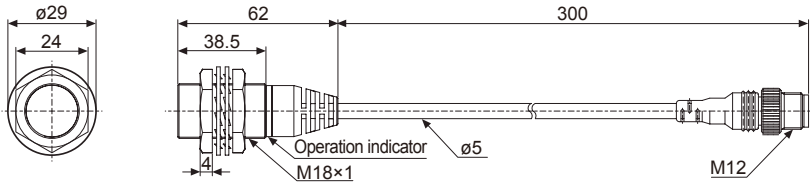

● PRDW(T)18-14D

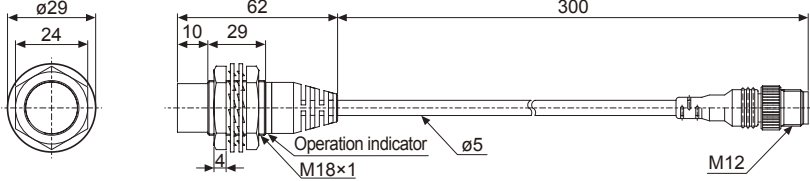

● PRDWL(T)18-7D

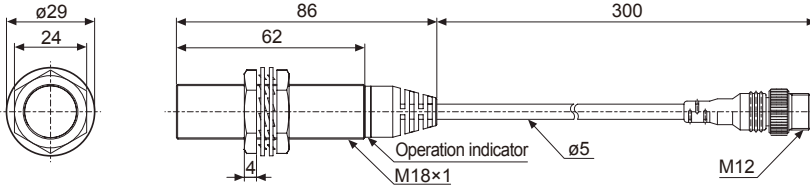

● PRDWL(T)18-14D

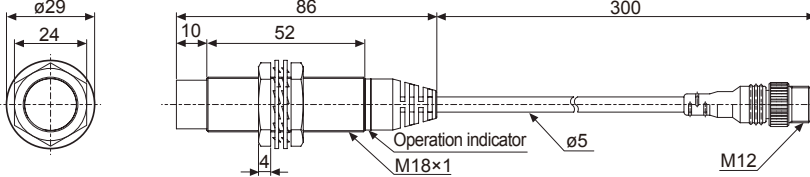

● PRDW(T)30-15D

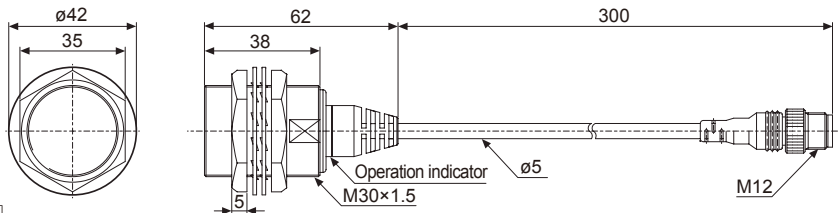

● PRDW(T)30-25D

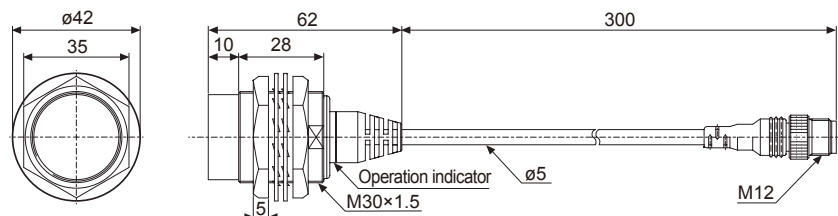

Long Distance Type

Dimensions

(unit: mm)

PRDWL(T)30-15D

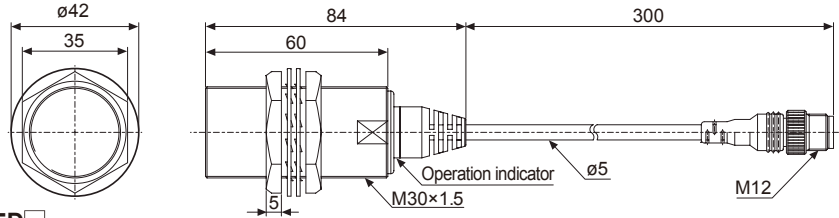

PRDWL(T)30-25D

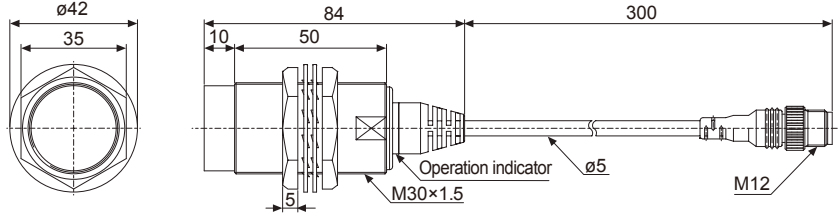

Control output diagram

DC 2-wire type

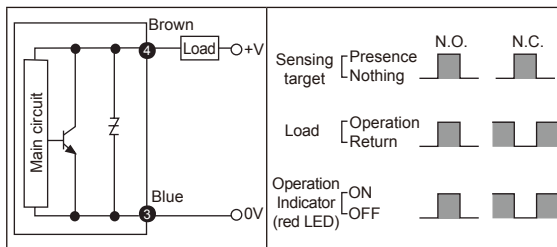

※The number in a circle is pin no. of connector.

DC 3-wire type

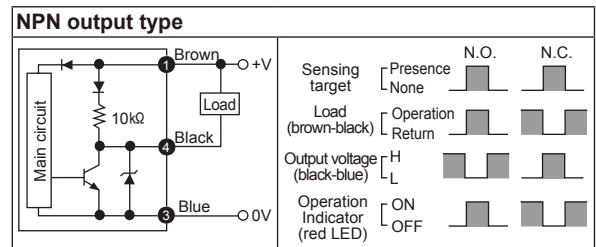

PNP output type

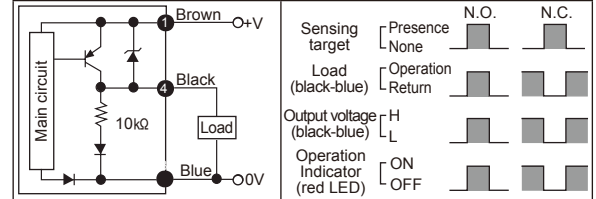

Connections

DC 2-wire type

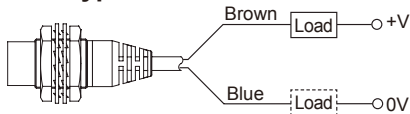

※The load can be connected to either wire.

DC 3-wire type

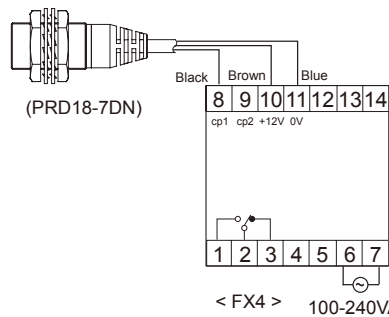
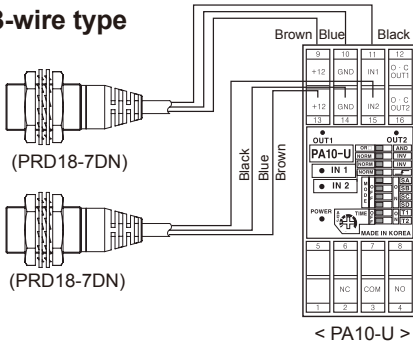

(A) Photo electric sensor

(B) Fiber optic sensor

(C) Door/Area sensor

(D) Proximity sensor

(E) Pressure sensor

(F) Rotary encoder

(G) Connector/Socket

(H) Temp. controller

(I) SSR/ Power controller

(J) Counter

(K) Timer

(L) Panel meter

(M) Tacho/ Speed/ Pulse meter

(N) Display unit

(O) Sensor controller

(P) Switching mode power supply

(Q) Stepper motor& Driver&Controller

(R) Graphic/ Logic panel

(S) Field network device

(T) Software

(U) Other

PRD/PRDW Series

■ Wiring diagram

◎ DC 2-wire type(Standard type)

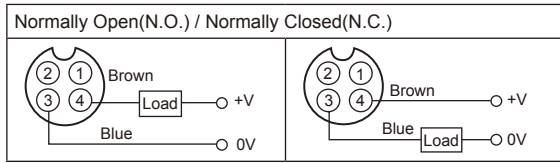

- ※Pin ①, ② are not used terminals.
- ※For DC 3-wire type connector cable, it is available to use with black wire(12-24VDC) and blue wire(0V).

◎ DC 2-wire type(IEC standard type)

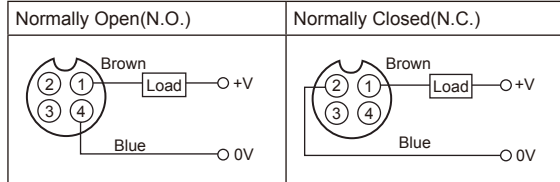

- ※②, ③ of N.O. type and ③, ④ of N.C. type are not used terminals.
- ※The pin arrangement of connector applying IEC standard is being developed.
- ※Please attach "I" at the end of the name of standard type for purchasing the IEC standard product. Ex)PRDWT12-4DO-I
- ※The connector cable for IEC standard is being developed. Please attach "I" at the end of the name of standard type. Ex)CID2-2-I, CLD2-5-I

◎ DC 3-wire type

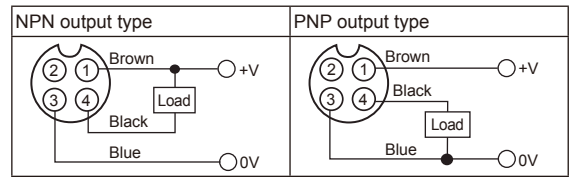

- ※Please fasten the cleat of connector not to shown the thread. (0.39 to 0.49N·m)
- ※Please fasten the vibration part with Teflon tape.
- ※Refer to the G-6 about IEC standard connector wires and specifications.

■ Proper usage

◎ Load connections

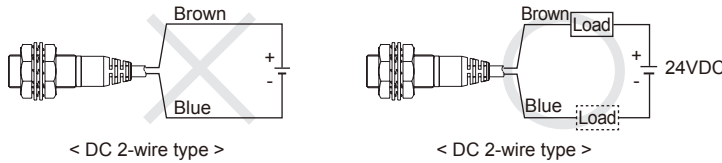

◎ In case of the load current is small

● DC 2-wire type

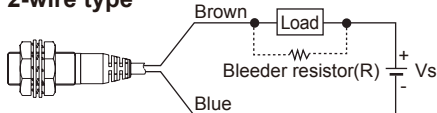

Please make the current on proximity sensor smaller than the return current of load by connecting a bleeder resistor in parallel.

※W value of Bleeder resistor should be bigger for proper heat dissipation.

$$R = \frac{V_s}{I_o - I_{off}} (\Omega) \quad P = \frac{V_s^2}{R} (W)$$

[V_s : Power supply, I_o : Min. action current of proximity sensor
 I_{off} : Return current of load, P : Number of Bleeder resistance watt]

◎ Mutual-interference

When several proximity sensors are mounted close to one another a malfunction of the sensor may be caused due to mutual interference. Therefore, be sure to provide a minimum distance between the two sensors as below chart indicates.

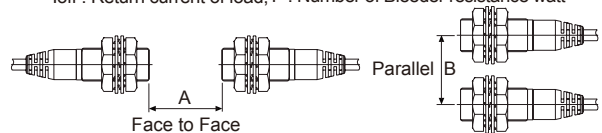

◎ Influence by surrounding metals

When sensors are mounted on metallic panel, you must prevent the sensors from being affected by any metallic object except target. Therefore, be sure to provide a minimum distance as below chart indicates.

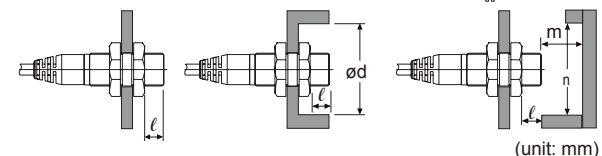

(unit: mm)

Model	PRDT12-4□□	PRDT12-8□□	PRDT18-7□□	PRDT18-14□□	PRDT30-15□□	PRDT30-25□□
Item	PRDWT12-4□□ PRDLT12-4□□	PRDWT12-8□□ PRDLT12-8□□	PRDWT18-7□□ PRDLT18-7□□ PRDWLT18-7□□	PRDWT18-14□□ PRDLT18-14□□ PRDWLT18-14□□	PRDWT30-15□□ PRDLT30-15□□	PRDWT30-25□□ PRDLT30-25□□
A	24	48	42	84	90	150
B	24	36	36	54	60	90
ℓ	0	11	0	14	0	15
ød	12	36	18	54	30	90
m	12	24	21	42	45	75
n	18	36	27	54	45	90

X-ON Electronics

Largest Supplier of Electrical and Electronic Components

Click to view similar products for [Autonics](#) manufacturer:

Other Similar products are found below :

[MT4W-DV-4N](#) [CR30-15AO](#) [E40S6-2500-6-L-5](#) [LP-S070-T9D6-C5T](#) [PRFT30-10DO-V](#) [PRFWT12-2DO-IV](#) [PRFWT30-10DO-IV](#) [TC4W-24R](#) [TK4H-14CC](#) [TX4S-B4C](#) [TX4S-B4S](#) [CR30-15AC](#) [PRD12-8DN](#) [TMHA-42AE](#) [TMHE-82RE](#) [CX6M-1P2](#) [PRFAT12-2DO-V](#) [PRFAWT12-2DO-IV](#) [PT4-S3DP5](#) [PT8-S3DP5](#) [SRH2-4440](#) [SRH3-4430](#) [SRHL1-4220](#) [TF33-31H-R](#) [E50S8-360-3-T-24](#) [BTF30-DDTL-P](#) [PR08-1.5DP2](#) [PRL30-10DP](#) [AT8PSN-6 100/120VAC](#) [CT6S-2P4](#) [BJ15M-TDT-P](#) [E40H12-1000-6-L-5](#) [PRCM12-2DN](#) [PRDCM12-4DN](#) [PRDCM18-14DN](#) [PRDCM18-7DN](#) [PRDCM30-25DN](#) [PRDCML12-8DN](#) [PRDCML18-7DP](#) [PRDCML30-25DN](#) [SR1-4425](#) [SR3-2450](#) [TK4H-14SC](#) [TK4H-14SR](#) [TK4M-14RN](#) [TK4N-14RC](#) [TX4S-A4S](#) [PR08-1.5DP](#) [PR18-5AO](#) [SR3-1440R](#)