

MAX-8

u-blox 8 GNSS modules

Data Sheet

Highlights

- High sensitivity of -166 dBm for single GNSS reception
- Cost-efficient system
- TCXO-based variant for fastest time to first fix
- Low power consumption
- Superior anti-spoofing and anti-jamming
- Pin-compatible with the MAX-7



www.u-blox.com

UBX-16000093 - R03

Document Information

Title	MAX-8		
Subtitle	u-blox 8 GNSS modules		
Document type	Data Sheet		
Document number	UBX-16000093		
Revision and Date	R03	26-Jul -2016	
Document status	Production Information		

Document status explanation

Objective Specification	Document contains target values. Revised and supplementary data will be published later.		
Advance Information	Document contains data based on early testing. Revised and supplementary data will be published later.		
Early Production Information	Document contains data from product verification. Revised and supplementary data may be published later.		
Production Information	Document contains the final product specification.		

This document applies to the following products:

Product name	Type number	ROM/FLASH version	PCN reference
MAX-8C	MAX-8C-0-10	ROM SPG 3.01	N/A
MAX-8Q	MAX-8Q-0-10	ROM SPG 3.01	N/A

u-blox reserves all rights to this document and the information contained herein. Products, names, logos and designs described herein may in whole or in part be subject to intellectual property rights. Reproduction, use, modification or disclosure to third parties of this document or any part thereof without the express permission of u-blox is strictly prohibited.

The information contained herein is provided "as is" and u-blox assumes no liability for the use of the information. No warranty, either express or implied, is given, including but not limited, with respect to the accuracy, correctness, reliability and fitness for a particular purpose of the information. This document may be revised by u-blox at any time. For most recent documents, visit www.u-blox.com.

Copyright © 2016, u-blox AG.

u-blox® is a registered trademark of u-blox Holding AG in the EU and other countries. ARM® is the registered trademark of ARM Limited in the EU and other countries.

Contents

Contents.....	3
1 Description.....	5
1.1 Overview	5
1.2 Product features	5
1.3 GNSS performance	6
1.4 Block diagram.....	7
1.5 Supported GNSS Constellations	7
1.5.1 GPS	7
1.5.2 GLONASS	7
1.6 Assisted GNSS (A-GNSS)	7
1.6.1 AssistNow™ Online	7
1.6.2 AssistNow™ Offline	8
1.6.3 AssistNow™ Autonomous	8
1.7 Augmentation Systems	9
1.7.1 Satellite-Based Augmentation System (SBAS).....	9
1.7.2 QZSS	9
1.7.3 Differential GPS (D-GPS).....	9
1.8 Odometer.....	9
1.9 Broadcast navigation data and satellite signal measurements.....	9
1.10 Geofencing	10
1.11 Message Integrity Protection	10
1.12 Spoofing Detection	10
1.13 EXTINT: External interrupt	10
1.13.1 Pin Control	10
1.13.2 Aiding	10
1.14 TIMEPULSE.....	10
1.15 Protocols and interfaces	11
1.16 Interfaces.....	11
1.16.1 UART.....	11
1.16.2 Display Data Channel (DDC)	11
1.17 Clock generation	11
1.17.1 Oscillators.....	11
1.17.2 Real-Time Clock (RTC)	11
1.18 Power management.....	12
1.18.1 DC/DC converter	12
1.18.2 Power Mode Setup.....	12
1.18.3 Continuous Mode	12
1.18.4 Power Save Mode	12
1.19 Antenna.....	13
1.19.1 Active antenna control (LNA_EN).....	13

1.20	Configuration management.....	13
2	Pin Definition.....	14
2.1	Pin assignment	14
3	Electrical specification.....	15
3.1	Absolute maximum rating	15
3.2	Operating conditions	16
3.3	Indicative current requirements.....	17
4	Mechanical specifications	18
5	Reliability tests and approvals	19
5.1	Reliability tests	19
5.2	Approvals	19
6	Product handling & soldering.....	19
6.1	Packaging.....	19
6.1.1	Reels	19
6.1.2	Tapes	19
6.2	Shipment, storage and handling	20
6.2.1	Moisture Sensitivity Levels	20
6.2.2	Reflow soldering	20
6.2.3	ESD handling precautions.....	21
7	Default messages	22
8	Labeling and ordering information.....	23
8.1	Product labeling.....	23
8.2	Explanation of codes.....	23
8.3	Ordering codes	23
	Related documents.....	24
	Revision history	24
	Contact.....	25

1 Description

1.1 Overview

The MAX-8 series of standard precision GNSS modules features the reliable performance of the u-blox 8 positioning engine, which receives GPS, GLONASS, QZSS and SBAS signals. The MAX-8 series delivers high sensitivity and minimal acquisition times in the ultra compact MAX form factor.

The economical MAX-8 series provides high sensitivity while featuring low power consumption and supporting advanced Power Save Modes. It also provides message integrity protection, geofencing, spoofing detection, and odometer functionalities.

The MAX-8C is optimized for cost sensitive applications with lowest power, while the MAX-8Q provides best performance. The industry proven MAX form factor allows easy migration from MAX-7 and MAX-6 modules by offering backward compatibility. Sophisticated RF-architecture and interference suppression ensure maximum performance even in GNSS-hostile environments.

The MAX-8 series combines a high level of integration capability with flexible connectivity options in a miniature package. This makes it perfectly suited for industrial and mass-market end products with strict size and cost requirements. The DDC (I2C compliant) interface provides connectivity and enables synergies with most u-blox cellular modules.

u-blox 8 modules use GNSS chips qualified according to AEC-Q100 and are manufactured in ISO/TS 16949 certified sites. Qualification tests are performed as stipulated in the ISO16750 standard: "Road vehicles – Environmental conditions and testing for electrical and electronic equipment". MAX-8Q complies with green/halogen free standards.

The u-blox MAX-8 modules can also benefit from the u-blox AssistNow assistance service. The Online service provides GNSS broadcast parameters, such as ephemeris, almanac data, and time, to reduce the receiver's time to first fix significantly and improve acquisition sensitivity. The extended validity of AssistNow Offline data (up to 35 days) and AssistNow Autonomous data (up to 3 days) provide faster acquisition after a long off time.



See section 1.6 for more information concerning AssistNow Assistance with the MAX-8 series.

1.2 Product features

Model	Category	GNSS				Supply	Interfaces	Features				Grade		
	Standard Precision GNSS High Precision GNSS Dead Reckoning Timing	GPS / QZSS GLONASS Galileo BeiDou	Number of Concurrent GNSS	1.65 V – 3.6 V 2.7 V – 3.6 V	UART USB SPI DDC (I ² C compliant)	Programmable (Flash) Data logging Additional SAW Additional LNA RTC crystal Oscillator Built-in antenna Built-in antenna supply and supervisor Timepulse	Standard Professional Automotive							
MAX-8C	•	• •	1	•	• •	◆ C	1							
MAX-8Q	•	• •	1	•	• •	• T	1							

◆ = Yes, but with a higher backup current

C = Crystal / T = TCXO

1.3 GNSS performance

Parameter	Specification		
Receiver type	72-channel u-blox 8 engine GPS L1C/A, SBAS L1C/A, QZSS L1C/A, GLONASS L1OF		
Accuracy of time pulse	RMS	30 ns	
	99%	60 ns	
Frequency of time pulse	0.25 Hz...10 MHz (configurable)		
Operational limits ¹	Dynamics	≤ 4 g	
	Altitude	50,000 m	
	Velocity	500 m/s	
Velocity accuracy ²	0.05 m/s		
Heading accuracy ²	0.3 degrees		
GNSS		GPS	GLONASS
Horizontal position accuracy ³	Autonomous	2.5 m	4.0 m
	SBAS	2.0 m	
Max navigation update rate ⁴		18 Hz	18 Hz
MAX-8Q			
Time-To-First-Fix ⁵	Cold start	29 s	30 s
	Hot start	1 s	1 s
	Aided starts ⁶	2 s	2 s
Sensitivity ⁷	Tracking & Navigation	-166 dBm	-166 dBm
	Reacquisition	-160 dBm	-156 dBm
	Cold start	-148 dBm	-145 dBm
	Hot start	-157 dBm	-156 dBm
MAX-8C			
Time-To-First-Fix ⁵	Cold start	30 s	33 s
	Hot start	1 s	1 s
	Aided starts ⁶	3 s	3 s
Sensitivity ⁷	Tracking & Navigation	-164 dBm	-163 dBm
	Reacquisition	-159 dBm	-156 dBm
	Cold start	-147 dBm	-145 dBm
	Hot start	-156 dBm	-155 dBm

Table 1: MAX-8 performance in different GNSS modes (default: single reception of GPS incl. SBAS and QZSS)

¹ Assuming Airborne < 4 g platform

² 50% @ 30 m/s

³ CEP, 50%, 24 hours static, -130 dBm, > 6 SVs

⁴ Rates with SBAS and QZSS enabled for > 98% fix report rate under typical conditions

⁵ All satellites at -130 dBm

⁶ Dependent on aiding data connection speed and latency

⁷ Demonstrated with a good external LNA

1.4 Block diagram

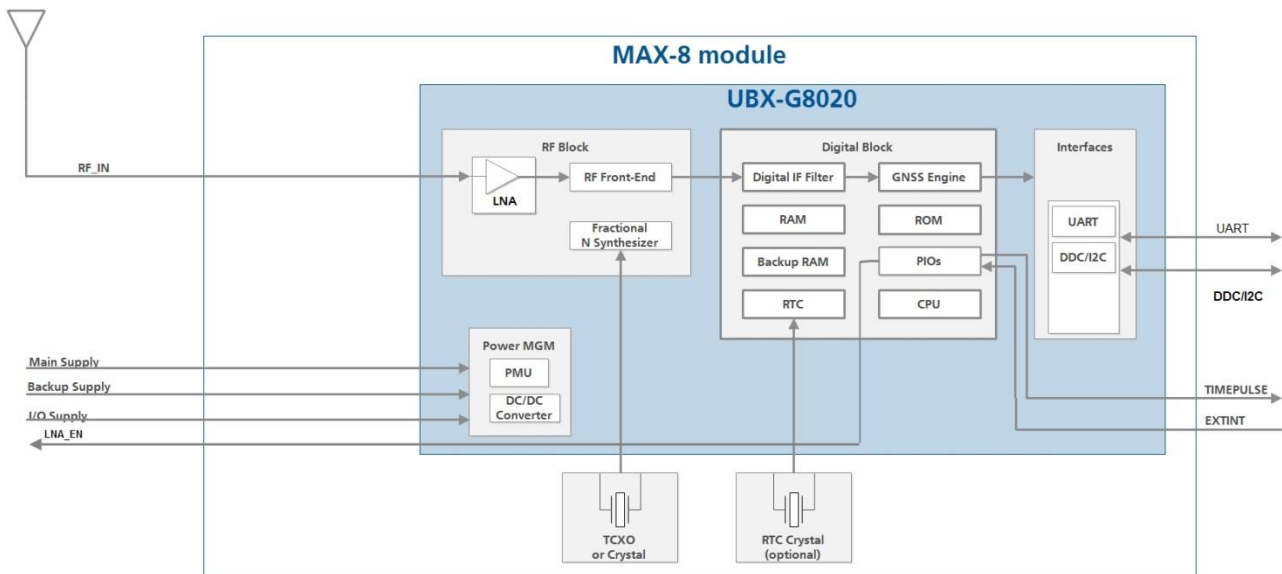

Figure 1: MAX-8 block diagram

1.5 Supported GNSS Constellations

MAX-8 modules are single GNSS receivers that can receive and track either GPS or GLONASS signals. By default, the MAX-8 receivers are configured for GPS, including SBAS and QZSS reception.

The augmentation systems: SBAS and QZSS can be enabled only if GPS operation is configured.

1.5.1 GPS

MAX-8 modules are designed to receive and track the L1C/A signals provided at 1575.42 MHz by the Global Positioning System (GPS). The MAX-8 series can receive and process GPS concurrently with QZSS and SBAS signals.

1.5.2 GLONASS

MAX-8 modules can receive and process the Russian GLONASS satellite system as an alternative to the US-based Global Positioning System (GPS). u-blox MAX-8 modules are designed to receive and track the L1OF signals GLONASS provides at $1602 \text{ MHz} + k \cdot 562.5 \text{ kHz}$, where k is the satellite's frequency channel number ($k = -7, \dots, 5, 6$). The ability to process GLONASS L1OF satellite signals allows design of GLONASS receivers where required by regulations.

To take advantage of GPS and GLONASS, dedicated hardware preparation must be made during the design-in phase. See the MAX-8 / MAX-M8 Hardware Integration Manual [1] for u-blox design recommendations.

1.6 Assisted GNSS (A-GNSS)

Supply of aiding information, such as ephemeris, almanac, rough last position and time, will reduce the time to first fix significantly and improve the acquisition sensitivity. All u-blox G8020 based products support the u-blox AssistNow Online and AssistNow Offline A-GNSS services, support AssistNow Autonomous, and are OMA SUPL compliant.

1.6.1 AssistNow™ Online

With AssistNow Online, an internet-connected GNSS device downloads assistance data from u-blox AssistNow Online Service to the receiver at system start-up. The Multi-GNSS Assistance (MGA) service is an HTTP protocol

based network operator independent service. Supplying assistance information, such as ephemeris, almanac, a rough last position and time, can reduce the time to first fix significantly and improve the acquisition sensitivity.



The AssistNow Online service provides data for GPS, GLONASS and QZSS.

1.6.2 AssistNow™ Offline

With AssistNow Offline service, users can download long-term orbit data over the Internet at their convenience. The orbit data must be stored in the memory of the application processor for subsequent down-load to the MAX-8 module. Thus the function enables a position fix within seconds, even when no network is available. AssistNow Offline offers augmentation for up to 35 days.



The AssistNow Offline service provides data for GPS and GLONASS.

1.6.3 AssistNow™ Autonomous

AssistNow Autonomous operation provides aiding information without the need for a host or external network connection. Based on previous broadcast satellite ephemeris data downloaded to and stored by the GNSS receiver, AssistNow Autonomous automatically generates accurate predictions of satellite orbital data (“AssistNow Autonomous data”) that is usable for future GNSS position fixes. The concept capitalizes on the periodic nature of GNSS satellite orbits by capturing strategic ephemeris data at specific times of the day. For MAX-8 modules, AssistNow Autonomous can calculate GPS-only orbit predictions for up to 3 days.

AssistNow Autonomous benefits are:

- Faster fix in situations where GNSS satellite signals are weak
- No connectivity required
- Compatible with AssistNow Online and Offline (can work stand-alone, or in tandem with these services)
- No integration effort; calculations are done in the background, transparent to the user.



For more details on A-GNSS, see the u-blox 8 / u-blox M8 Receiver Description Including Protocol Specification [2].

1.7 Augmentation Systems

1.7.1 Satellite-Based Augmentation System (SBAS)

The MAX-8 modules support reception of SBAS broadcast signals. These systems supplement GPS data with additional regional or wide area GPS augmentation data. The system broadcasts augmentation data via satellite and this information can be used by GNSS receivers to improve the resulting precision. SBAS satellites can also be used as additional signals for ranging (navigation), further enhancing availability. The following SBAS types are supported: WAAS, EGNOS and MSAS.

 For more details see the u-blox 8 / u-blox M8 Receiver Description Including Protocol Specification [2].

1.7.2 QZSS

The Quasi-Zenith Satellite System (QZSS) is a regional navigation satellite system that transmits additional GPS L1C/A signals for the Pacific region covering Japan and Australia. The MAX-8 modules are able to receive and track these signals concurrently with GPS signals, resulting in better availability especially under challenging signal conditions, e.g. in urban canyons.

 The L1-SAIF signal provided by QZSS is not supported

1.7.3 Differential GPS (D-GPS)

u-blox receivers support Differential-GPS data according to RTCM specification 10402.3 [5]: The use of D-GPS improves GPS position accuracy. The RTCM implementation supports the following RTCM 2.3 messages:

Message Type	Description
1	Differential GPS Corrections
2	Delta Differential GPS Corrections
3	GPS Reference Station Parameters
9	GPS Partial Correction Set

Table 2: Supported RTCM 2.3 messages

 RTCM corrections cannot be used together with SBAS.

 For more details see the u-blox 8 / u-blox M8 Receiver Description Including Protocol Specification [2].

1.8 Odometer

The odometer provides information on travelled ground distance (in meters) using solely the position and Doppler-based velocity of the navigation solution. For each computed travelled distance since the last odometer reset, the odometer estimates a 1-sigma accuracy value. The total cumulative ground distance is maintained and saved in the BBR memory.

 The odometer feature is disabled by default. For more details see the u-blox 8 / u-blox M8 Receiver Description Including Protocol Specification [2].

1.9 Broadcast navigation data and satellite signal measurements

u-blox 8 receivers can output all the GNSS broadcast data upon reception from tracked satellites. This includes all the supported GNSS signals plus the augmentation services SBAS and QZSS. The receiver also makes available the tracked satellite signal information, i.e. raw code phase and Doppler measurements in a form aligned to the ETSI mobile cellular location services protocol (RRLP) [6]. For more details see the u-blox 8 / u-blox M8 Receiver Description Including Protocol Specification [2].

1.10 Geofencing

The u-blox MAX-8 modules support up to four circular geofencing areas defined on the Earth's surface using a 2D model. Geofencing is active when at least one geofence is defined. The current status can be found by polling the receiver.

1.11 Message Integrity Protection

The MAX-8 modules provide a function to prevent a third party interfering with the UBX message stream sent from receiver to host. The security mechanism essentially "signs" nominated messages with a following message containing an md5 generated hash of the nominated message. This message signature is then compared with one generated by the host to determine if the message data has been altered. The hash algorithm seed can use one fixed secret ID-key set by eFuse in production or a dynamic ID-key set by host enabling users to detect "Man-in-the-middle" style attacks.

1.12 Spoofing Detection

Spoofing is a process whereby a malicious third party tries to control the reported position via a "fake" GNSS broadcast signal. This may result in the form of reporting incorrect position, velocity or time. To combat this, the MAX-8 modules include anti-spoofing measures to alert the host when signals appear to be suspicious. The receiver combines a number of checks on the received signals looking for inconsistencies across several parameters.



This feature does not guarantee detection of all spoofing attacks

1.13 EXTINT: External interrupt

EXTINT is an external interrupt pin with fixed input voltage thresholds with respect to **VCC_IO**. It can be used for control of the receiver or for aiding.

For more information on how to implement and configure these features see the u-blox 8 / u-blox M8 Receiver Description Including Protocol Specification [2] and the MAX-8 / MAX-M8 Hardware Integration Manual [1].

1.13.1 Pin Control

The pin control feature allows overriding the automatic active/inactive cycle of Power Save Mode. The state of the receiver can be controlled through the **EXTINT** pin.

The receiver can also be turned off and sent into Backup Mode using **EXTINT** when Power Save Mode is not active.

1.13.2 Aiding

The **EXTINT** pin can be used to supply time or frequency aiding data to the receiver.

For time aiding, hardware time synchronization can be achieved by connecting an accurate time pulse to the **EXTINT** pin.

Frequency aiding can be implemented by connecting a periodic rectangular signal with a frequency up to 500 kHz and arbitrary duty cycle (low/high phase duration must not be shorter than 50 ns) to the **EXTINT** pin, and providing the applied frequency value to the receiver using UBX messages.

1.14 TIMEPULSE

A configurable time pulse signal is available with all u-blox MAX modules.

The **TIMEPULSE** output generates pulse trains synchronized with a GNSS or UTC time grid, with intervals configurable over a wide frequency range. Thus it may be used as a low frequency time synchronization pulse or as a high frequency reference signal.

By default the time pulse signal is configured to 1 pulse per second. For more information see the u-blox 8 / u-blox M8 Receiver Description Including Protocol Specification [2].

1.15 Protocols and interfaces

Protocol	Type
NMEA 0183, version 4.0 (V2.1, V2.3 or V4.1 configurable)	Input/output, ASCII
UBX	Input/output, binary, u-blox proprietary
RTCM	Input, message 1, 2, 3, 9

Table 3: Available Protocols

All protocols are available on UART and DDC (I²C compliant). For specification of the various protocols see the u-blox-8 / u-blox M8 Receiver Description Including Protocol Specification [2].

1.16 Interfaces

A number of interfaces are provided either for data communication or memory access. The embedded firmware uses these interfaces according to their respective protocol specifications.

1.16.1 UART

MAX-8 modules include one UART interface, which can be used for communication to a host. It supports configurable baud rates. For supported baud rates see the u-blox 8 / u-blox M8 Receiver Description Including Protocol Specification [2].



Designs must allow access to the UART and the **SAFEBOOT_N** function pin for future service and reconfiguration.

1.16.2 Display Data Channel (DDC)

An I²C compliant DDC interface is available for communication with an external host CPU or u-blox cellular modules. The interface can be operated in slave mode only. The DDC protocol and electrical interface are fully compatible with the Fast-Mode of the I²C industry standard. Since the maximum SCL clock frequency is 400 kHz, the maximum transfer rate is 400 kb/s.

The DDC interface is I²C Fast Mode compliant. For timing parameters consult the I²C standard.



The maximum bit rate is 400 kb/s. The interface stretches the clock when slowed down while serving interrupts, so real bit rates may be slightly lower.

1.17 Clock generation

1.17.1 Oscillators

MAX-8 modules are available in Crystal and TCXO versions. The TCXO option allows accelerated weak signal acquisition, enabling faster start and reacquisition times.

Oscillators used on MAX-8 modules are carefully selected and screened for stability and against frequency perturbations across the full operating range (−40° to +85°C).

The careful selection and qualification of critical parts, such as GNSS oscillators, has resulted in u-blox modules being the most reliable positioning modules in the industry, particularly in challenging conditions.

1.17.2 Real-Time Clock (RTC)

The RTC is driven by a 32 kHz oscillator, which makes use of an RTC crystal. If the main supply voltage fails and a battery is connected to V_BCKP, parts of the receiver switch off, but the RTC still runs providing a timing reference for the receiver. This operating mode is called Hardware Backup Mode, which enables all relevant data to be saved in the backup RAM to allow a hot or warm start later.

With MAX-8C in Hardware Backup Mode, the main oscillator is used as timing reference instead of the 32 kHz oscillator. MAX-8C applies single crystal mode, where the 26 MHz crystal oscillator can also be used to provide a

frequency reference to the RTC without using an additional crystal for the RTC. This makes MAX-8C a more cost efficient solution at the expense of a higher backup current.



For more information see the MAX-8 / MAX-M8 Hardware Integration Manual [1]

1.18 Power management

u-blox 8 technology offers a power optimized architecture with built-in autonomous power saving functions to minimize power consumption at any given time. Furthermore, the receiver can be used in two operating modes: Continuous mode for best performance or Power Save Mode for optimized power consumption respectively. In addition, a high efficiency DC/DC converter is integrated to allow low power consumption even for higher main supply voltages.

1.18.1 DC/DC converter

MAX-8Q and MAX-8C modules integrate a DC/DC converter, allowing reduced power consumption by up to 50%, especially when using a main supply voltage above 2.5 V.



For more information see the MAX-8 / MAX-M8 Hardware Integration Manual [1]

1.18.2 Power Mode Setup

The u-blox MAX-8 modules can be configured to run in either continuous or a choice of Power Save Mode configurations. A template of power mode settings can be used to easily select typical power mode setups to cover the majority of users' requirements.

For specific power saving applications the user has the option to fully configure via the power save mode configuration. For more information see section 1.18.4.

The u-blox 8 receivers' power mode setup offers a choice of continuous operation and preset Power Save Mode Configurations:

- Continuous (default) mode for best GNSS performance
- Continuous with no compromise in power consumption
- A 1 Hz cyclic tracking mode for aggressive power reduction
Choice of 2 or 4 Hz cyclic tracking modes for typical wearable applications
- ON/OFF interval mode

1.18.3 Continuous Mode

Continuous Mode uses the acquisition engine at full performance, resulting in the shortest possible TTFF and the highest sensitivity. The receiver searches for all possible satellites until the almanac is completely downloaded. The receiver then switches to the tracking engine to lower the power consumption.

Thus, a lower tracking current consumption level will be achieved when:

- A valid GNSS position is obtained
- The entire almanac has been downloaded
- The ephemeris for each satellite in view is valid

1.18.4 Power Save Mode

For power sensitive applications, u-blox 8 receivers provide a Power Save Mode for reduced power consumption. Power Save Mode provides two dedicated methods, ON/OFF and Cyclic tracking, that reduce average current consumption in different ways to match the needs of the specific application. These options can be set by using a specific UBX message.



For more information about power management strategies, see the u-blox 8 / u-blox M8 Receiver Description Including Protocol Specification [2].

1.19 Antenna

MAX-8 modules are designed for use with passive⁸ and active⁹ antennas.

Parameter	Specification	
Antenna Type	Passive and active antenna	
Active Antenna Recommendations	Minimum gain	15 dB (to compensate signal loss in RF cable)
	Maximum gain	50 dB
	Maximum noise figure	1.5 dB

Table 4: Antenna Specifications for all MAX-8 modules

1.19.1 Active antenna control (LNA_EN)

The **LNA_EN** Pin can be used to turn on and off an external LNA or an active antenna. This reduces power consumption in Power Save Mode (Backup mode). This pin is available on the MAX-8C and MAX-8Q modules.

1.20 Configuration management

Configuration settings can be modified with UBX configuration messages. The modified settings remain effective until power-down or reset. If these settings have been stored in battery-backup RAM, then the modified configuration will be retained, as long as the backup battery supply is not interrupted.



For more information about configuration management, see the u-blox 8 / u-blox M8 Receiver Description Including Protocol Specification [2].

⁸ For integration MAX-8 modules with Cellular products, see the MAX-8 / MAX-M8 Hardware Integration Manual [1]

⁹ For information on using active antennas with MAX-8 modules, see the MAX-8 / MAX-M8 Hardware Integration Manual [1].

2 Pin Definition

2.1 Pin assignment

10	GND	RESET_N	9
11	RF_IN	VCC	8
12	GND	VCC_IO	7
13	LNA_EN	V_BCKP	6
14	VCC_RF	EXTINT	5
15	Reserved	TIMEPULSE	4
16	SDA	RXD	3
17	SCL	TXD	2
18	SAFEBOOT_N	GND	1

MAX-8
Top View

Figure 2: Pin Assignment

No	Name	PIO ¹⁰ Nr.	I/O	Description
1	GND	-		Ground
2	TXD	6	O	Serial Port
3	RXD	7	I	Serial Port
4	TIMEPULSE	11	O	Time pulse (1PPS)
5	EXTINT	13	I	External Interrupt Pin
6	V_BCKP	-		Backup voltage supply
7	VCC_IO	-		IO Supply Voltage
8	VCC	-		Supply voltage
9	RESET_N	-	I	RESET_N
10	GND	-		Ground
11	RF_IN	-	I	GNSS signal input
12	GND	-		Ground
13	LNA_EN	16	O	Antenna / External LNA control
14	VCC_RF	-		Output Voltage RF section
15	Reserved	-	-	Reserved
16	SDA	9	I/O	DDC Data
17	SCL	8	I/O	DDC Clock
18	SAFEBOOT_N	-	I	SAFEBOOT_N (for future service and reconfiguration, leave OPEN)

Table 5: Pinout



Pins designated Reserved should not be used. For more information about Pinouts see the MAX-8 / MAX-M8 Hardware Integration Manual [1].

¹⁰ Peripheral Input Output

3 Electrical specification



The limiting values given are in accordance with the Absolute Maximum Rating System (IEC 134). Stress above one or more of the limiting values may cause permanent damage to the device. These are stress ratings only, and operation of the device at these or at any other conditions above those given in the Characteristics sections of the specification is not implied. Exposure to these limits for extended periods may affect device reliability.



Where application information is given, it is advisory only and does not form part of the specification. For more information see the MAX-8 / MAX-M8 Hardware Integration Manual [1].

3.1 Absolute maximum rating

Parameter	Symbol	Module	Condition	Min	Max	Units
Power supply voltage	VCC, VCC_IO	All		-0.5	3.6	V
Backup battery voltage	V_BCKP	All		-0.5	3.6	V
Input pin voltage	V _{in}	All		-0.5	VCC_IO+0.5	V
DC current through any digital I/O pin (except supplies)	I _{pin}				10	mA
VCC_RF output current	ICC_RF	All			100	mA
Input power at RF_IN	P _{fin}	All	source impedance = 50 Ω, continuous wave		15	dBm
Antenna bias voltage	V_ANT				6	V
Antenna bias current	I_ANT				100	mA
Storage temperature	T _{stg}	MAX-8C		-40	105	°C
		MAX-8Q		-40	85	°C

Table 6: Absolute maximum ratings



Stressing the device beyond the “Absolute Maximum Ratings” may cause permanent damage. These are stress ratings only. The product is not protected against overvoltage or reversed voltages. If necessary, voltage spikes exceeding the power supply voltage specification, given in table above, must be limited to values within the specified boundaries by using appropriate protection diodes.

3.2 Operating conditions



All specifications are at an ambient temperature of 25°C. Extreme operating temperatures can significantly impact specification values. Applications operating near the temperature limits should be tested to ensure the specification.

Parameter	Symbol	Module	Min	Typ	Max	Units	Condition
Power supply voltage	VCC, VCC_IO	MAX-8C	1.65	3.0	3.6	V	
		MAX-8Q	2.7	3.0	3.6	V	
Backup battery voltage	V_BCKP	All	1.4		3.6	V	
Backup battery current	I_BCKP	MAX-8Q		15		μA	V_BCKP = 3.0 V, VCC = 0 V
		MAX-8C		100		μA	V_BCKP = 3.0 V, VCC = 0 V
SW backup current	I_SWBCKP	MAX-8Q		20		μA	VCC = 3.0 V
		MAX-8C		105		μA	VCC = 3.0 V
Input pin voltage range	V _{in}	All	0		VCC_IO	V	
Digital IO Pin Low level input voltage	V _{il}	All	0		0.2*VCC_IO	V	
Digital IO Pin High level input voltage	V _{ih}	All	0.7*VCC_IO		VCC_IO+0.5	V	
Digital IO Pin Low level output voltage	V _{ol}	All			0.4	V	I _{ol} =4 mA
Digital IO Pin High level output voltage	V _{oh}	All	VCC_IO - 0.4			V	I _{oh} =4 mA
Pull-up resistor for RESET_N (Internal)	R _{pu}	All		11		kΩ	
V_ANT antenna bias voltage	V_ANT	2.7			5.5	V	I _{ANT} < -50 mA
Antenna bias voltage drop	V_ANT_DROP		0.1			V	ICC_RF =50 mA
VCC_RF voltage	VCC_RF	All		VCC - 0.1		V	
VCC_RF output current	ICC_RF	All			50	mA	
Receiver Chain Noise Figure ¹¹	NF _{tot}	All		3.5		dB	
Operating temperature	Topr	All	-40		85	°C	

Table 7: Operating conditions



Operation beyond the specified operating conditions can affect device reliability.

¹¹ Only valid for the GPS band

3.3 Indicative current requirements

Table 8 lists examples of the total system supply current for a possible application.



Values in Table 8 are provided for customer information only as an example of typical power requirements. Values are characterized on samples. Actual power requirements can vary depending on FW version used, external circuitry, number of SVs tracked, signal strength, type of start as well as time, duration and conditions of test.

Parameter	Symbol	Module	Typ GPS/QZSS/SBAS	Typ GLONASS	Max	Unit s	Condition
Max. supply current ¹²	Iccp	All			67	mA	Estimated at 3 V
		Icc Acquisition ¹⁵	MAX-8C	18	17	mA	Estimated at 3 V
			MAX-8Q	19	18	mA	Estimated at 3 V
Average supply current ^{13, 14}	Icc Tracking (Continuous mode,)	MAX-8C	16	16		mA	Estimated at 3 V
		MAX-8Q	17	17		mA	Estimated at 3 V
	Icc Tracking (Power Save mode / 1 Hz)	MAX-8C	3.8	3.7		mA	Estimated at 3 V
		MAX-8Q	4.7	4.7		mA	Estimated at 3 V

Table 8: Indicative power requirements at 3.0 V



For more information about power requirements, see the MAX-8 / MAX-M8 Hardware Integration Manual [1].



For more information on how to noticeably reduce current consumption, see the Power Management Application Note [4].

¹² Use this figure to dimension maximum current capability of power supply. Measurement of this parameter with 1 Hz bandwidth.

¹³ Use this figure to determine required battery capacity.

¹⁴ Simulated GNSS constellation using power levels of -130 dBm. VCC= 3.0 V

¹⁵ Average current from start-up until the first fix.

4 Mechanical specifications

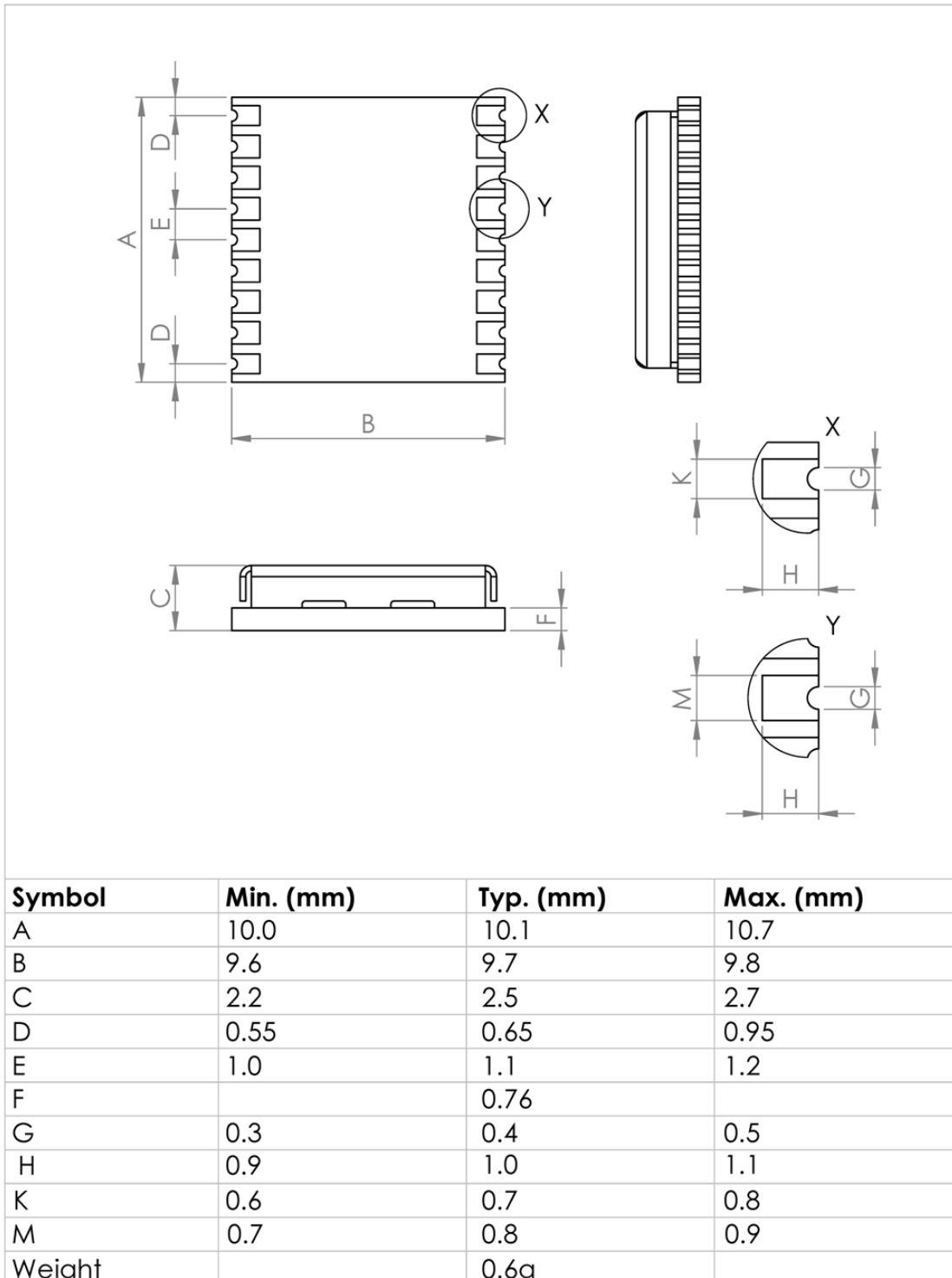

Figure 3: Dimensions



For information about the paste mask and footprint, see the MAX-8 / MAX-M8 Hardware Integration Manual [1].

5 Reliability tests and approvals

5.1 Reliability tests



All MAX-8 modules are based on AEC-Q100 qualified GNSS chips.

Tests for product family qualifications are according to ISO 16750 "Road vehicles – Environmental conditions and testing for electrical and electronic equipment", and appropriate standards.

5.2 Approvals



Products marked with this lead-free symbol on the product label comply with the "Directive 2002/95/EC of the European Parliament and the Council on the Restriction of Use of certain Hazardous Substances in Electrical and Electronic Equipment" (RoHS).

All u-blox 8 GNSS modules are RoHS compliant.

6 Product handling & soldering

6.1 Packaging

MAX-8 modules are delivered as hermetically sealed, reeled tapes in order to enable efficient production, production lot set-up and tear-down. For more information see the u-blox Package Information Guide [3].

6.1.1 Reels

Each reel has 500 MAX-8 GNSS modules . MAX-8 modules are shipped on Reel Type B, as specified in the u-blox Package Information Guide [3].

6.1.2 Tapes

Figure 4 shows the position and orientation of MAX-8 modules as they are delivered on tape. The dimensions of the tapes are specified in Figure 5.

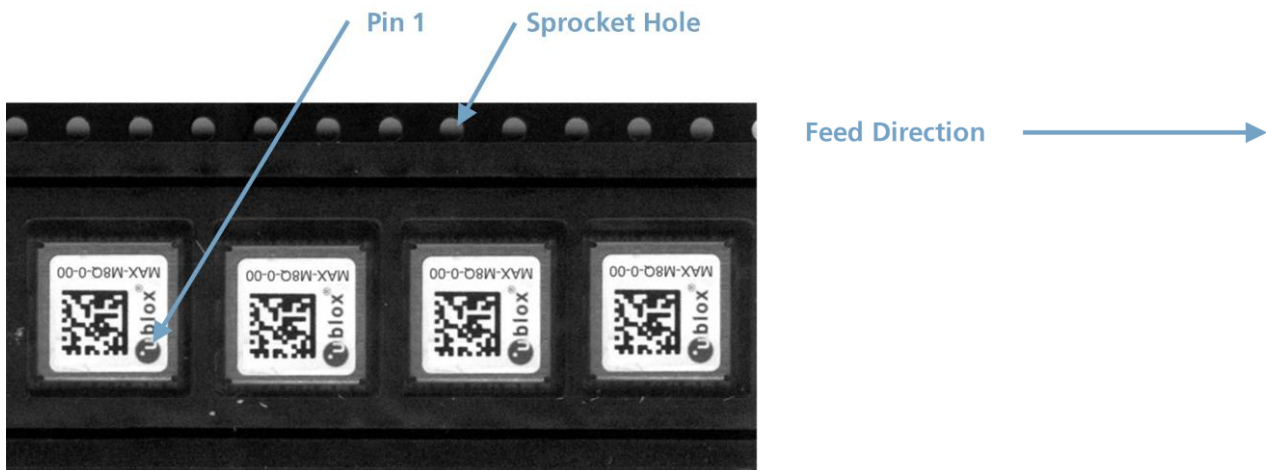

Figure 4: Tape and module orientation

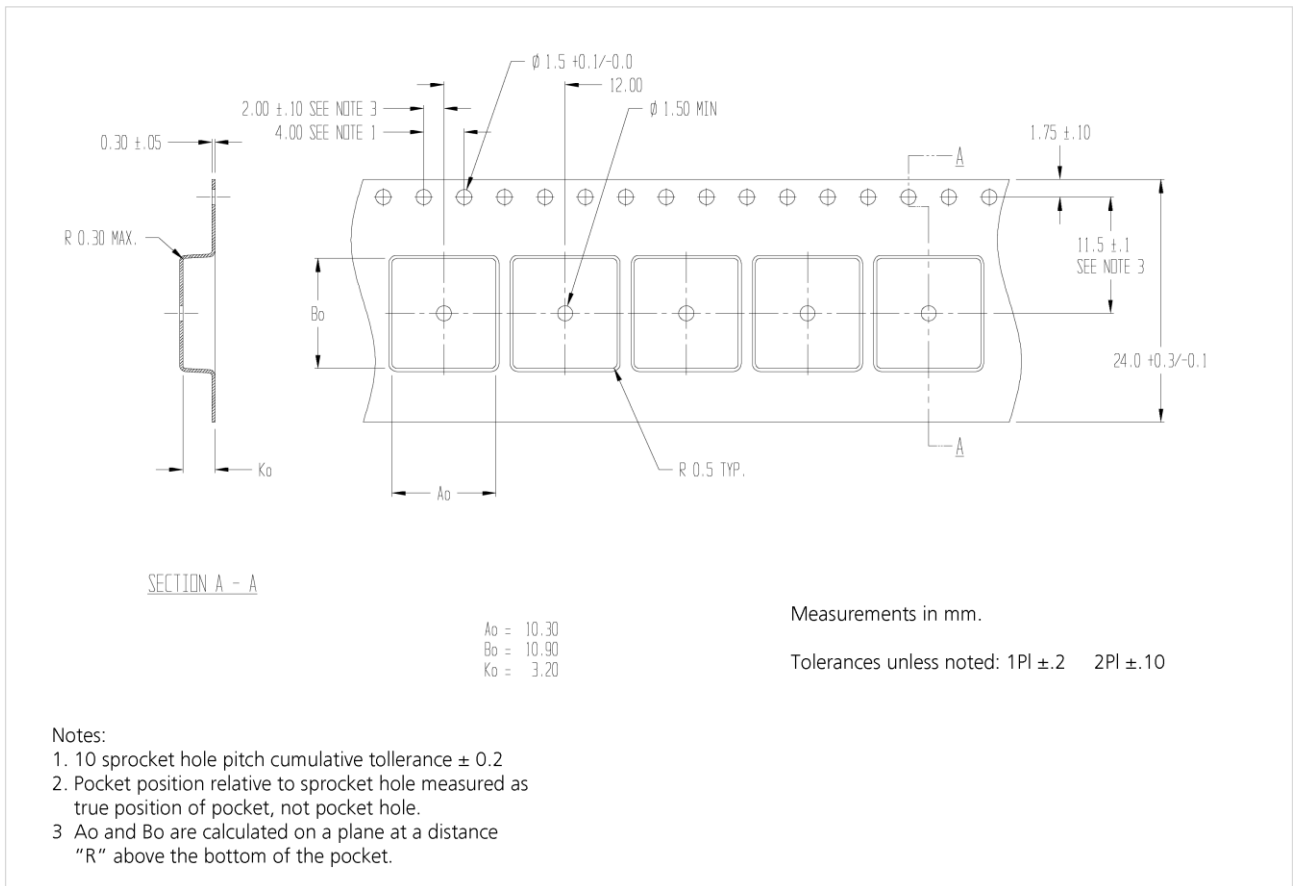

Figure 5: MAX-8 Tape dimensions

6.2 Shipment, storage and handling

For more information regarding shipment, storage and handling see the u-blox Package Information Guide [3].

6.2.1 Moisture Sensitivity Levels

The Moisture Sensitivity Level (MSL) relates to the packaging and handling precautions required. MAX-8 modules are rated at MSL level 4.



For MSL standard see IPC/JEDEC J-STD-020, which can be downloaded from www.jedec.org.

6.2.2 Reflow soldering

Reflow profiles are to be selected according to u-blox recommendations (see the MAX-8 / MAX-M8 Hardware Integration Manual [1]).

6.2.3 ESD handling precautions

 **MAX-8 modules are Electrostatic Sensitive Devices (ESD). Observe precautions for handling! Failure to observe these precautions can result in severe damage to the GNSS receiver!**

GNSS receivers are Electrostatic Sensitive Devices (ESD) and require special precautions when handling. Particular care must be exercised when handling patch antennas, due to the risk of electrostatic charges. In addition to standard ESD safety practices, the following measures should be taken into account whenever handling the receiver:

- Unless there is a galvanic coupling between the local GND (i.e. the work table) and the PCB GND, then the first point of contact when handling the PCB must always be between the local GND and PCB GND.
- Before mounting an antenna patch, connect ground of the device
- When handling the RF pin, do not come into contact with any charged capacitors and be careful when contacting materials that can develop charges (e.g. patch antenna ~10 pF, coax cable ~50 to 80 pF/m, soldering iron, ...)
- To prevent electrostatic discharge through the RF input, do not touch any exposed antenna area. If there is any risk that such exposed antenna area is touched in non ESD protected work area, implement proper ESD protection measures in the design.
- When soldering RF connectors and patch antennas to the receiver's RF pin, make sure to use an ESD safe soldering iron (tip).

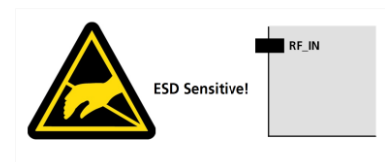

7 Default messages

Interface	Settings
UART Output	9600 Baud, 8 bits, no parity bit, 1 stop bit Configured to transmit both NMEA and UBX protocols, but only the following NMEA (and no UBX) messages have been activated at start-up: GGA, GLL, GSA, GSV, RMC, VTG, TXT
UART Input	9600 Baud, 8 bits, no parity bit, 1 stop bit, Autobauding disabled Automatically accepts following protocols without need of explicit configuration: UBX, NMEA, RTCM The GNSS receiver supports interleaved UBX and NMEA messages.
DDC	Fully compatible with the I ² C industry standard, available for communication with an external host CPU or u-blox cellular modules; operated in slave mode only. NMEA and UBX are enabled as input messages, only NMEA as output messages Maximum bit rate 400 kb/s.
TIMEPULSE (1Hz Nav)	1 pulse per second, synchronized at rising edge, pulse length 100 ms

Table 9: Default messages



Refer to the u-blox 8 / u-blox M8 Receiver Description Including Protocol Specification [2] for information about further settings.

8 Labeling and ordering information

8.1 Product labeling

The labeling of u-blox MAX-8 GNSS modules includes important product information. The location of the product type number is shown in Figure 6.

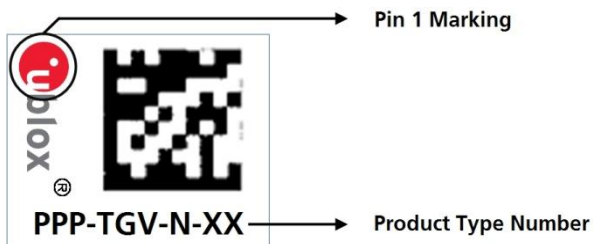

Figure 6: Location of product type number on MAX-8 module label

8.2 Explanation of codes

Three different product code formats are used. The **Product Name** is used in documentation such as this data sheet and identifies all u-blox 8 products, independent of packaging and quality grade. The **Ordering Code** includes options and quality, while the **Type Number** includes the hardware and firmware versions. Table 10 shows the structure of these three different formats.

Format	Structure
Product Name	PPP-TGV
Ordering Code	PPP-TGV-N
Type Number	PPP-TGV-N-XX

Table 10: Product Code Formats

The parts of the product code are explained in Table 11.

Code	Meaning	Example
PPP	Product Family	MAX
TG	Product Generation	8 = u-blox 8
V	Variant	Function set (A-Z), T = Timing, R = DR, etc.
N	Option / Quality Grade	Describes standardized functional element or quality grade 0 = Default variant, A = Automotive
XX	Product Detail	Describes product details or options, such as hardware or software revision, cable length, etc.

Table 11: part identification code

8.3 Ordering codes

Ordering No.	Product
MAX-8C-0	u-blox 8 GNSS LCC Module, Crystal, ROM, 9.7x10.1 mm, 500 pieces/reel
MAX-8Q-0	u-blox 8 GNSS LCC Module, TCXO, ROM, Green, 9.7x10.1 mm, 500 pieces/reel

Table 12: Product ordering codes for professional grade modules



Product changes affecting form, fit or function are documented by u-blox. For a list of Product Change Notifications (PCNs) see our website.

Related documents

- [1] MAX-8 / MAX-M8 Hardware Integration Manual, Docu. No. UBX-15030059
- [2] u-blox 8 / u-blox M8 Receiver Description Including Protocol Specification (Public version), Doc. No. UBX-13003221
- [3] u-blox Package Information Guide, Docu. No. UBX-14001652
- [4] Power Management Application Note, Docu. No. UBX-13005162
- [5] RTCM 10402.3 Recommended Standards for Differential GNSS, Ver. 2.3, RTCM AUG. 20, 2001
- [6] Radio Resource LCS Protocol (RRLP), (3GPP TS 44.031 version 11.0.0 Release 11)



For regular updates to u-blox documentation and to receive product change notifications, register on our homepage (<http://www.u-blox.com>).

Revision history

Revision	Date	Name	Status / Comments
R01	25-Apr-2016	ghun	Objective Specification
R02	25-May-2016	Julu	Advance Information
R03	26-Jul-2016	ghun	Production Information

Contact

For complete contact information visit us at www.u-blox.com

u-blox Offices

North, Central and South America

u-blox America, Inc.

Phone: +1 703 483 3180
E-mail: info_us@u-blox.com

Regional Office West Coast:

Phone: +1 408 573 3640
E-mail: info_us@u-blox.com

Technical Support:

Phone: +1 703 483 3185
E-mail: support@u-blox.com

Headquarters Europe, Middle East, Africa

u-blox AG

Phone: +41 44 722 74 44
E-mail: info@u-blox.com
Support: support@u-blox.com

Asia, Australia, Pacific

u-blox Singapore Pte. Ltd.

Phone: +65 6734 3811
E-mail: info_ap@u-blox.com
Support: support_ap@u-blox.com

Regional Office Australia:

Phone: +61 2 8448 2016
E-mail: info_auz@u-blox.com
Support: support_ap@u-blox.com

Regional Office China (Beijing):

Phone: +86 10 68 133 545
E-mail: info_cn@u-blox.com
Support: support_cn@u-blox.com

Regional Office China (Chongqing):

Phone: +86 23 6815 1588
E-mail: info_cn@u-blox.com
Support: support_cn@u-blox.com

Regional Office China (Shanghai):

Phone: +86 21 6090 4832
E-mail: info_cn@u-blox.com
Support: support_cn@u-blox.com

Regional Office China (Shenzhen):

Phone: +86 755 8627 1083
E-mail: info_cn@u-blox.com
Support: support_cn@u-blox.com

Regional Office India:

Phone: +91 80 4050 9200
E-mail: info_in@u-blox.com
Support: support_in@u-blox.com

Regional Office Japan (Osaka):

Phone: +81 6 6941 3660
E-mail: info_jp@u-blox.com
Support: support_jp@u-blox.com

Regional Office Japan (Tokyo):

Phone: +81 3 5775 3850
E-mail: info_jp@u-blox.com
Support: support_jp@u-blox.com

Regional Office Korea:

Phone: +82 2 542 0861
E-mail: info_kr@u-blox.com
Support: support_kr@u-blox.com

Regional Office Taiwan:

Phone: +886 2 2657 1090
E-mail: info_tw@u-blox.com
Support: support_tw@u-blox.com

X-ON Electronics

Largest Supplier of Electrical and Electronic Components

Click to view similar products for [GPS Modules](#) category:

Click to view products by [U-Blox](#) manufacturer:

Other Similar products are found below :

[A5135-H](#) [EWM-G109H01E](#) [ISM3333-C6.1](#) [S2-106ZN](#) [S2-105V4-Z185K](#) [MIKROE-4150](#) [GPS-11858](#) [4037735104327](#) [RXM-GNSS-TM-T](#)
[EWM-G108H01E](#) [DD-14239](#) [GPS-10922](#) [GPS-12751](#) [NEO-M8P-2](#) [SIM28ML](#) [RXM-GNSS-GM-T](#) [SIM28](#) [M10578-A3](#) [M10578-A3-U2](#)
[TEL0132](#) [POL-2G](#) [POL-3G](#) [FT-X-GPS](#) [GPS-13740](#) [PKG300060P](#) [PKG300071](#) [PKG300071P](#) [PKG900000000271T](#) [PKG900000000853P](#)
[PKG900000000853T](#) [EZ-GPS-G](#) [A2235H](#) [RXM-GNSS-TM-B](#) [RXM-GPS-F4-T](#) [RXM-GPS-FM-B](#) [RXM-GPS-FM-T](#) [RXM-GPS-R4-T](#)
[A1084-A](#) [A2100-A](#) [A2200-A](#) [A2235-H](#) [A5100-A](#) [28504](#) [L26ADR-S89](#) [L26T-S89](#) [L89-S90](#) [101990655](#) [113990659](#) [GPS-13670](#) [TESEO-](#)
[LIV3F](#)