

**PLUGS, SOCKETS
& ADAPTORS**



We have all points covered.



INSULATED PINS
now available on
Clipsal plugs.



PLUGS, SOCKETS & ADAPTORS



C O N T E N T S

4	Plugs, Sockets & Adaptors Introduction
6	How To Order Section Plugs
8	Cord Extension Sockets
9	Surface Sockets
10	Miscellaneous Products
13	Insulated Pins
14	Plug Selection Chart
16	Product Detail Section Flexible Plugs
19	Quick Connect Plugs
20	Rigid Plastic Plugs & Appliance Plugs
21	Clock Point Plugs & Side Entry Plugs
22	Safety Plug
23	Plug and Socket Set Couplings
24	Cord Extension Socket Selection Chart
25	Flexible Cord Extension Sockets
26	Quick Connect Extension Sockets
27	Adaptors
28	Surface Sockets
34	Flush Sockets
40	Weatherproof Inlets
41	Weatherproof Outlets
42	Associated Products
43	Plugs, Sockets & Adaptors Product Listing

PLUGS, SOCKETS & ADAPTORS

PLUGS, SOCKETS & ADAPTORS

When it comes to domestic and commercial industrial plugs, sockets and cord extension sets, the Clipsal range is without peer for choice and quality.

We are continually adding to the range with innovative and exciting new products created to meet both consumer and contractor demand.

This Technical Data Catalogue outlines the vast number of products available, including our LifeSaver protected models, appliance cords and plugs.

All products are manufactured in accordance with AS3100, AS/NZS3112, AS3109, AS/NZS3122 and other relevant Australian and New Zealand Standards.

This catalogue also briefly outlines our range of cord extension sets and our extensive Industrial range of sockets and plugs.

Approvals and certification

Where required all Clipsal plugs, sockets and adaptors have been approved by the **Department of Mines and Energy (South Australia)** and carry the Approval Mark **S/1**.



WE HAVE ALL POINTS COVERED



Insulated Pins

As of April 3rd 2005*, specified products sold to end-users are required to have insulated pins. Clipsal endorsed this safety measure by changing the way we manufacture our electric plugs. Clipsal have created a means of applying a layer of insulation directly to the electrical pins without adding to the overall width. This also provides a layer of protection between you and an active circuit.

Just look for the addition of the letter 'S' to Catalogue Numbers to identify an insulated pin product.

* Check with your local State regulator for the latest updates on this Standard.

HOW TO ORDER PLUGS

Clipsal offers a range of Appliance Plugs, Flexible Two, Three & Four Pin Plugs, Quick Connect Three & Four Pin Plugs, Rigid Two & Three Pin Plugs & Side Entry Plugs. Please see below for a list of each type of plug

and a brief description. All products are rated at 250V unless specified. Highlighted section of catalogue numbers are generally an abbreviation of the plugs feature (eg. 439SHD is a **Heavy Duty** plug).

Flexible Three-Pin Plugs

Flexible three-pin plugs, as a rule, have the prefix "439". Versions with insulated, active and neutral pins have the prefix "439S" ("S" stands for safety).

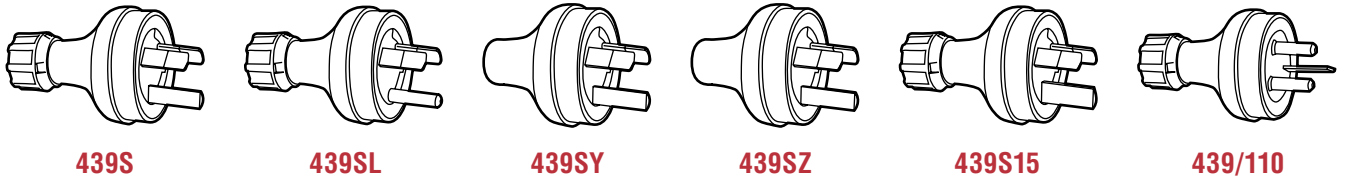

439	S						Flexible Plug with insulated active and neutral pins, 10A rating
439	S	U	A				439S (Unassembled), 10A rating
439	S	H	D				Heavy Duty, 10A rating
439	S	H	D	U	A		439SHD (Unassembled), 10A rating
439	S	L					Round earth for Lighting, 10A rating
439	S	L	U	A			439SL (Unassembled), 10A rating
439	S	L	H	D			Round earth for Lighting, Heavy Duty, 10A rating
439	S	N					Neon indicator, 10A rating
439	S	X	H	D			Extra Heavy Duty, 10A rating

439	S	Y					Plug for Figure 8 flex, 10A rating	
439	S	Y	U	A			439SY (Unassembled), 10A rating	
439	S	Z					Plug for Light Duty flex, 10A rating	
439	S	Z	U	A			439SZ (Unassembled), 10A rating	
439	S	1	5				15A rating	
439	S	1	5	U	A		15A rating (Unassembled)	
439	S	1	5	H	D		15A rating, Heavy Duty	
439	S	1	5	H	D	U	A	439S15HD (Unassembled)
439	/	1	1	0			Flexible Plug with two round pins, 110V, 10A rating	

Rigid Three-Pin Plug

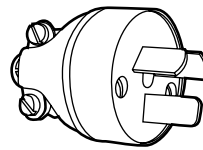

425HD

425HD	Rigid Plastic Plug with three pins, Heavy Duty, 20A rating
-------	--

Side Entry Plugs

Side entry plugs refer to the fact that the cable enters the plug from the side. These plugs are all prefixed with "418S", indicating they all have insulated pins ("S" stands for safety). Other Catalogue Number variations are due to assembly of product, pin configuration or amperage.

418S							Side Entry Plug with insulated active and neutral pins, 10A rating
418S	U	A					418S (Unassembled)
418S	L						Round earth for Lighting, 10A rating
418S	L	U	A				418SL (Unassembled)
418S	1	5					Side Entry Plug with insulated active and neutral pins, 15A rating

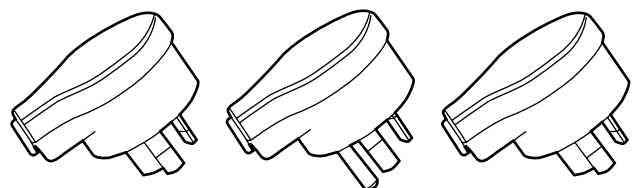

418S

418SL

418S15

Quick Connect Three and Four-Pin Plugs

The Quick Connect three and four-pin plugs, as a rule, have the prefix “1439”. Versions with insulated, active and neutral pins have the prefix “1439S” (“S” stands for safety). Other Catalogue Number variations are due to differences in recommended cable, plug amperage or pin quantity.

1439	S		Quick Connect Plug with insulated active and neutral pins, 10A rating
1439	S	H D	Heavy Duty, 10A rating
1439	S	1 5	15A rating
1439	/	2 0	Quick Connect Plug with three pins and 20A rating
1439	/	4 P	Quick Connect Plug with four pins, 10A rating

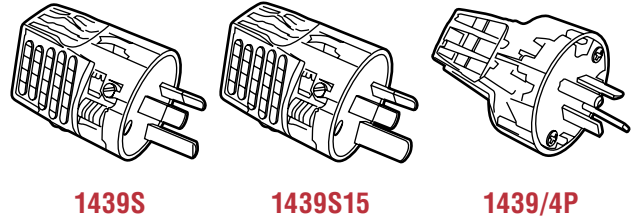

Flexible Two-Pin Plugs

Flexible two-pin plugs are prefixed with the number “492”. Two-pin parallel plugs do not require insulated pins to comply with Australian/New Zealand Standards.

492			Flexible Plug with two parallel pins, 10A
492	Y		Flexible Plug with two parallel pins, figure 8 cable entry size, 10A
492	/	3 2	Flexible Plug with two polarised pins, 32V, 15A

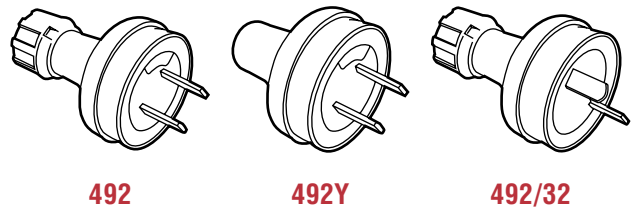

Flexible Four-Pin Plugs

Flexible four-pin plugs are prefixed with the number “439/4”. Four-pin plugs do not require insulated pins to comply with Australian/New Zealand Standards.

439/4			Flexible Plug with four pins, 10A
439/4	U A		439/4 (Unassembled), 10A

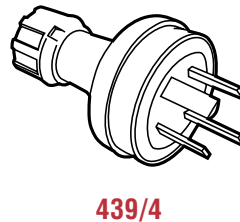

Appliance Plugs

Appliance plugs are all prefixed with the numbers “464” or “465”. Other Catalogue Number variations are due to differences in keyways or pin arrangements.

464			Domestic Appliance Plug, two pin, 7.5A
465			International Appliance Plug with keyway, three pin, 10A
465	C		International Appliance Plug, three pin, 10A
465	C	2	International Appliance Plug, two pin, 10A

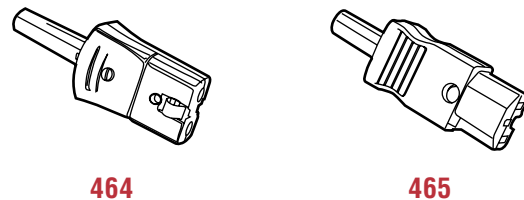

HOW TO ORDER CORD EXTENSION SOCKETS

Cord Extension Sockets are available in two pin, three pin and quick connect models. Please see below for Catalogue Numbers and their descriptions. All products are rated at 250V unless otherwise specified. All extension sockets have the prefix “438” or have “438” within the Catalogue Number.

Highlighted section of catalogue numbers are generally an abbreviation of the extension socket’s main features, cable suitability or current rating (eg. 438L is a **Lighting** socket).

Flexible Three-Pin Cord Extension Sockets

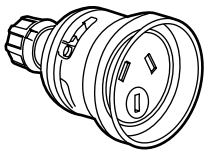

438

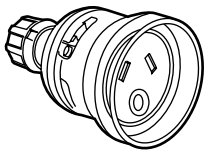

438L

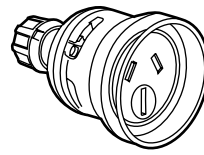

438S15

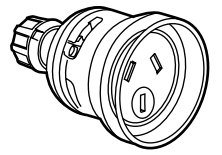

438XHD

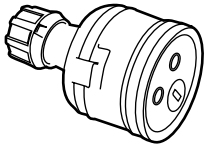

438/110

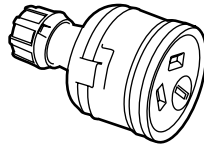

438/15

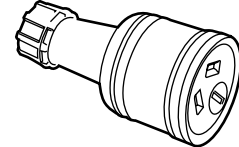

438/20

438						Flexible Cord Extension Socket with three pins, 10A rating
438	U	A				438 (Unassembled)
438	L					Round earth for Lighting, 10A rating
438	L	U	A			438L (Unassembled)
438	L	H	D			Round earth for Lighting, heavy duty, 10A rating
438	H	D				Heavy duty, 10A rating
438	H	D	U	A		438HD (Unassembled)
438	N					Neon, 10A rating

438	S	1	5			Shrouded, 15A rating		
438	X	H	D			Extra heavy duty, 10A rating		
438	X	H	D	U	A	438XHD (Unassembled)		
438	/	1	1	0		110V, 10A rating		
438	/	1	5			15A rating		
438	/	1	5	H	D	15A rating, heavy duty		
438	/	1	5	H	D	U	A	438/15HD (Unassembled)
438	/	2	0			20A rating		
438	/	2	0	H	D	20A rating, heavy duty		

Flexible Two-Pin Cord Extension Sockets

438/	2	Flexible Cord Extension Socket with two parallel pins, 250V, 10A rating
438/	3 2	Flexible Cord Extension Socket with two polarised pins, 32V, 15A rating

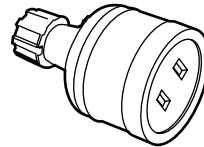

438/2

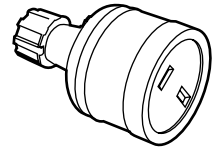

438/32

Quick Connect Extension Sockets

1438						Quick Connect Extension Socket with three pins, 10A rating
1438	H	D				Heavy Duty, 10A rating
1438	/	1	5			15A rating

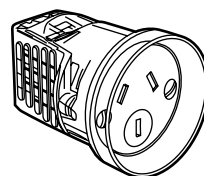

1438

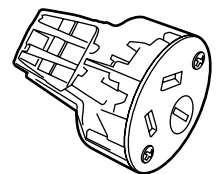

1438/15

HOW TO ORDER SURFACE SOCKETS

Clipsal also offers a range of Surface Sockets, including Front Connecting Surface Sockets, Standard Base Surface Socket & Rear Connecting Three Pin, Twin Three Pin & Four Pin Surface Sockets.

Front Connecting Surface Sockets

Front connecting surface sockets are prefixed with either “402” (2-Pin) or “412” (3-Pin). Other Catalogue Number variations are due to differences in product voltage, amperage or pin shape.

402				Front Connecting Surface Socket with two parallel flat pins, 250V, 10 rating
402	/	3	2	Front Connecting Surface Socket with two polarised pins, 32V, 15A
412				Front Connecting Surface Socket with three pins, 250V, 10A rating
412	L			Front Connecting Surface Socket with three pins, round earth for Lighting, 250V, 10A rating
412	/	1	5	Front Connecting Surface Socket with three pins, 250V, 15A rating
412	/	1	0	Front Connecting Surface Socket with three pins, 110V, 10A rating

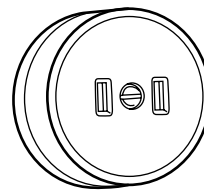

402

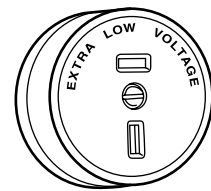

402/32

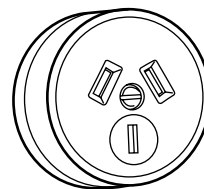

412

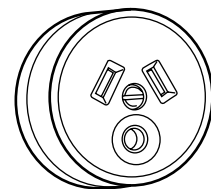

412L

Standard Base Surface Socket

412A110	Standard Base Surface Socket with three pins, 110V, 10A
---------	---

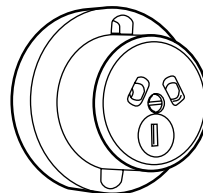

412A110

Rear Connecting Single Three-Pin Surface Sockets

Rear connecting single three-pin surface sockets are all prefixed with “413”. Other Catalogue Number variations are due to differences in terminal/pin arrangements, amperage or connection method. All products are rated at 250V unless specified. Highlighted section of catalogue numbers generally refer to the product’s main features (eg. 413QC is a **Quick Connect** surface socket).

413				Rear Connecting Surface Socket with three pins, 10A rating, one looping terminal
413	/	5		Two looping terminals, 10A rating
413	/	1	5	15A rating, one looping terminal
413	F			Complete with fast fixing screws, 10A rating
413	L			Round earth for lighting, 10A rating
413	QC			Quick connect, 10A rating

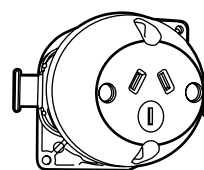

413

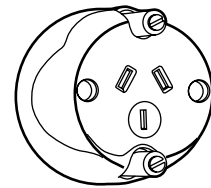

413F

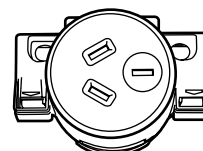

413QC

HOW TO ORDER SURFACE SOCKETS

Rear Connecting Twin Three-Pin Surface Sockets

414 Series are supplied with twin sockets arrangements.

414		Rear Connecting Surface Socket, twin, three pins, 250V, 10A rating
414	L	Rear Connecting Surface Socket, twin, three pins, round earth for lighting, 250V, 10A rating

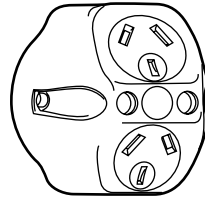

414

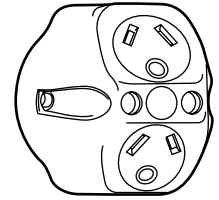

414L

Rear Connecting Four-Pin Surface Sockets

Rear connecting surface sockets are all prefixed with either “410”, “413” or “414”. 410, 413 and 414/4P Series have specific socket configurations that adapt to four-pin plugs.

410		Rear Connecting Surface Socket with four pins, single, 500V, 10A rating
413	/4P	Rear Connecting Surface Socket with four pins, single, 250/440V, 10A rating
414	/4P	Rear Connecting Surface Socket with four pins, twin, 250/440V, 10A rating

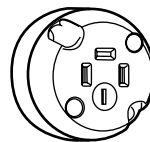

410

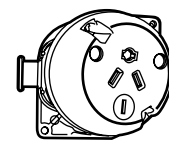

413/4P

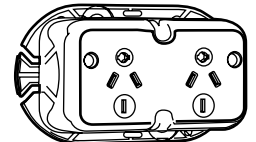

414/4P

HOW TO ORDER MISCELLANEOUS PRODUCTS

Rear Connecting Flush Sockets

Rear connecting flush sockets are all prefixed with “426”. Other Catalogue Number variations are due to pin shape (round earth) or for current rating.

426		Rear Connecting Flush Socket with three pins, 10A rating
426	L	Rear Connecting Flush Socket with three pins, round earth for lighting, 10A rating
426	/15	Rear Connecting Flush Socket with three pins, 15A

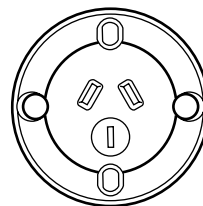

426

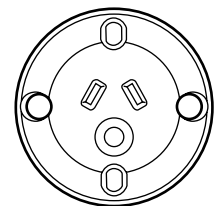

426L

Clock Point Plugs

Clock point plugs are all prefixed with “409/”. Other Catalogue Number variations are due to pin quantity or pin configuration.

409/	3	Clock Point Plug, three pin, 5A rating
409/	3 A	Clock Point Plug, three pin, alternative configuration, 5A rating
409/	4	Clock Point Plug, four pins, 5A rating

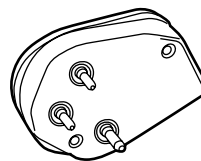

409/3

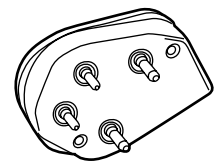

409/4

Safety Shield

417	All insulated safety plug
-----	---------------------------

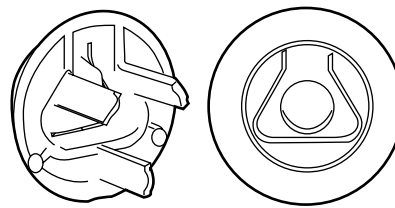

417

Plug and Socket Set Couplings

Highlighted section of catalogue numbers generally refer to the product's main features (eg. 437SS is a Cord Extension Socket & Plug with **insulated active and neutral pins**). The complete plug and socket set coupling series is prefixed with "437".

437	S	S			Cord Extension Socket and Plug with three insulated pins (includes rubber locking device)
437	P	S	A	S	Cord Extension Socket & Plug with three insulated pins, weatherprotected threaded coupling
437	P	S			Threaded Coupling Set, weatherprotected
437	P	R			Plug Top Coupling Ring, 62mmØ, 33mm deep, weatherprotected
437	S	R			Cord Extension Socket Coupling Ring, 66mmØ, 56mm deep, weatherprotected
437	P				Plug Coupling Ring, 53mmØ, 38mm deep, weatherprotected
437	S				Cord Extension Socket Coupling Ring, 64mmØ, 40mm deep, weatherprotected

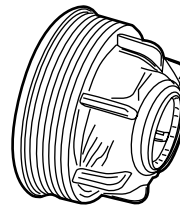

437S

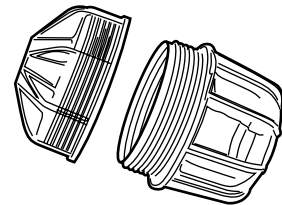

437PS

Adaptors

Clipsal Adaptors are generally known as the 460 Series. The 463SF has the suffix "SF" to indicate that it has integrated Surge Filter components.

460S	Dual Adaptor with 3 Pins, 10A rating
463SF	Overvoltage Surge Filter Plug Adaptor with three pins, 10A rating

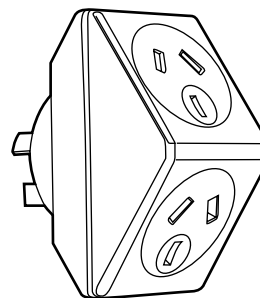

460S

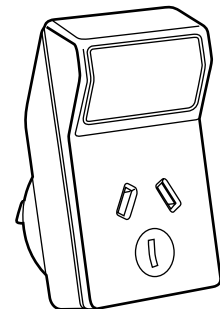

463SF

HOW TO ORDER MISCELLANEOUS PRODUCTS

Fixing Plates for Loom Wiring

411			Loom Wiring Fixing Plate, screw fixed		
413	F	P	Loom Wiring Fixing Plate, clipped on		
413	N	P	Loom Wiring Fixing Plate, for the use of cable ties for cable clamping		
413	N	P	Q	C	As above, suits 413QC Series

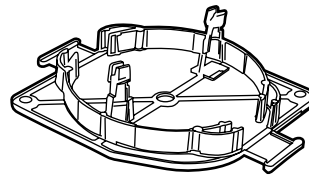

413NP

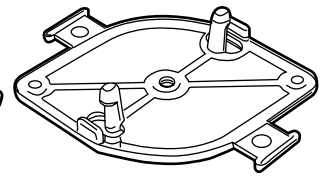

413NPQC

Clock Point Sockets

Clock point sockets are all prefixed with “408/”. Other Catalogue Number variations are due to differences in pin configuration or pin quantity.

408/	3	Clock Point Socket with three pins, 250V, 5A rating	
408/	3	A	Clock Point Socket with three pins, alternative configuration, 250V, 5A rating
408/	4	Clock Point Socket with four pins, 250V, 5A rating	

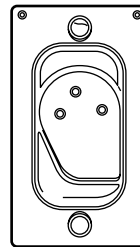

408/3

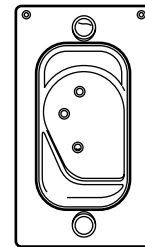

408/3A

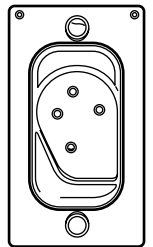

408/4



INSULATED PINS

Recently the electrical standards of Australia and New Zealand were updated to reflect a safety requirement. As of 3rd April 2005 all products sold to end users are required to have insulated pins. Please refer to your local regulatory authority for the latest information on the implementation date. Some states/regions have extended the sale of non-insulated pin plugs beyond this date.

Clipsal endorsed this safety measure by changing the way they manufacture their electrical plugs, anticipating the move by integrating the insulated pins into their product lines since 1998.

What are insulated pins?

Clipsal has created a means of applying a layer of insulation directly to the electrical pins without adding to the overall width. Providing a layer of protection between you and an active circuit.

Why do we need insulation?

Research has shown that with the insulated protection applied to the pins the safety of a workplace or home can be greatly enhanced. Previously an electrocution could occur from contact with a live electrical pin

exposed from an incorrectly or partially inserted electrical plug; the shock occurring when the pins come into contact with a thin conductive material like that of a metal knife or Venetian blind.

Having the insulation covering the majority of the active and neutral pins will allow for an added layer of safety. Answering the recent change to the Australian standard requesting that all active and neutral pins on low voltage plugs shall be of the insulated pin type by 3rd April 2005.

What to look for?

Clipsal has created two packaging symbols so that you can easily recognise a product with the new safety insulated pins. A circular version of the Safety plug symbol will appear on most packaging whereas a rectangular version will appear on header cards and wholesale point of sale material and other promotional pieces. Keep an eye out for the introduction of the new symbols on all Clipsal packaging.

In some cases, catalogue numbers will be slightly altered to allow for the new safety pins, appearing with the addition of the letter S (for safety).

Products with Changes to Catalogue Number

Old	New
418	418S
418/15	418S15
418L	418SL
418LUA	418SLUA
418UA	418SUA
437	437SS
437PSA	437PSAS
439	439S
439L	439SL
439LHD	439SLHD
439LUA	439SLUA
439N	439SN
439HD	439SHD
439HDUA	439SHDUA
439XHD	439SXHD
439UA	439SUA

Old	New
439/15	439S15
439/15UA	439S15UA
439/15HD	439S15HD
439/15HDUA	439S15HDUA
439Y	439SY
439YUA	439SYUA
439Z	439SZ
439ZUA	439SZUA
463AS	463SAS
463UA	463SUA
1439	1439S
1439/15	1439S15
1439HD	1439SHD
460,WE	460S,WE
461UA	461SUA







































Products with No Changes to Catalogue Number

800/2	800/20	800XHD10RC	800A2
800/3	800HD3	800XHD20	800E.5
800/4	800HD5	800PA2	800E1
800/5	800HD7	801/30	800E2
800/6	800HD9	801/20HD	
800/7	800HD10	801/20R	
800/8	800HD20	801/30HD	
800/10	800HD30	800A.5	
800/15	800XHD10	800A1	













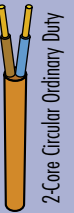

More information is available in our **Insulated Pins brochure** (Brochure O/N 7633)

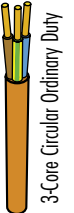

PLUG SELECTION CHART

RECOMMENDED PLUGS		DIMENSIONS (AS3191)	FLEXIBLE CORDS
0.5mm ²	 464		3-Core Circular Ordinary Duty
	 439SY	6.6mm x 4.3mm	2-Core Flat Ordinary Duty
	 439SUA		
	 492Y		
	 492	5.8mm Ø	2-Core Circular Light Duty
	 492	6.6mm Ø	2-Core Circular Ordinary Duty
	 418S	6.1mm Ø	3-Core Circular Light Duty
	 418SL		
	 418SUA	7mm Ø	3-Core Circular Ordinary Duty
	 418SL		
	 439SUA		
	 439S		
 439SHD	9mm Ø	3-Core Circular Heavy Duty	
 439SHDUA			
 439SL			
 439SZ			
 439SUA			
 439SN			
 439/110			
 439/4			
 439/4P			
1mm ² (32/0.2) 10A	 492	7mm Ø	2-Core Circular Ordinary Duty
	 465C2		
	 418S	7.4mm Ø	3-Core Circular Ordinary Duty
	 418SL		
	 439S		
	 439SL		
	 439SUA		
	 439SN		
	 439/110		
	 439/4		
	 465		
	 439SHD	9.5mm Ø	3-Core Circular Heavy Duty
 439SHDUA			
 439SLHD			
 1439SHD			
 439/4	7.8mm Ø	4-Core Circular Ordinary Duty	
 1439/4P			

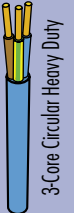
PLUG SELECTION CHART

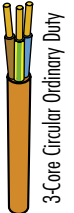
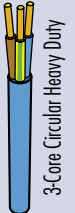
RECOMMENDED PLUGS		DIMENSIONS (AS3191)	FLEXIBLE CORDS
 492  492/32		7.9mm Ø	 2-Core Circular Ordinary Duty
 418S15  439S15  439S15UA  439S15HDUA  1439S15		8.6mm Ø	 3-Core Circular Ordinary Duty
 439S15HD  439SXHD  425HD  1439/20		10.5mm Ø	 3-Core Circular Heavy Duty
 439SXHD  425HD		10.6mm Ø	 3-Core Circular Ordinary Duty  3-Core Circular Heavy Duty
			2.5mm ² (50/0.25) 20A
			1.5mm ² (30/0.25) 15A



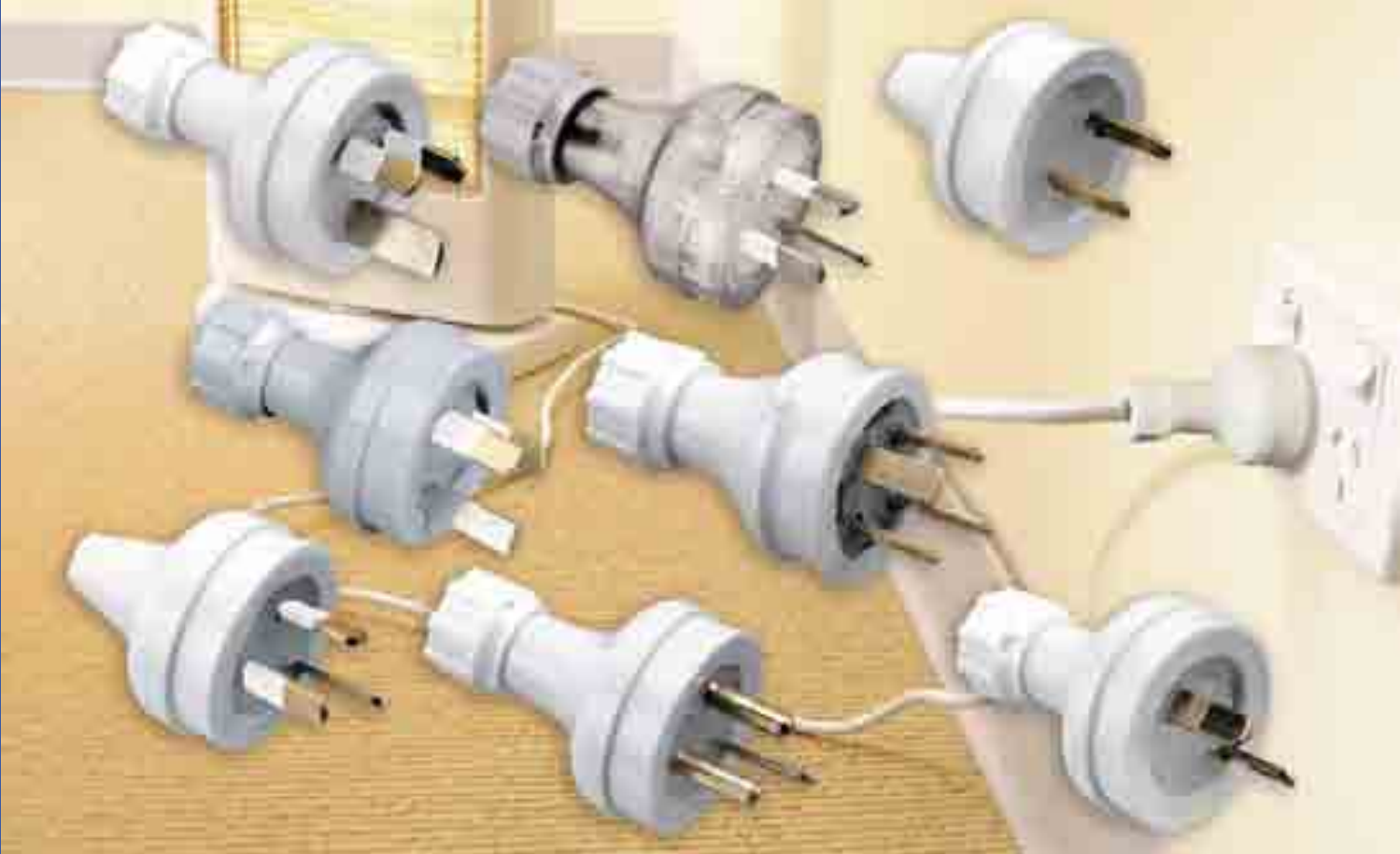

Flexible Plugs

Flexible yet unbreakable, these plugs feature an internal cord anchor and external cord grip to keep cords firmly in place. Terminal pin clamp screws are riveted and backed off ready for fast flexible cord connection.

Flexible plugs are available in 10A, 15A and 20A configurations with covers and cord grips to suit various cable sizes. Also available are two pin, three pin and four pin configuration models. An instant external visual check for correct connections is provided in the base of plug.

The standard colour for all models is Grey, but they are also available in Transparent, White Electric, Black and Electric Orange, unless otherwise indicated.

Flexible Three-Pin Plugs

Clipsal offers a wide range of flexible 3 pin plugs in standard 10A and 15A configurations, as well as round earth pin models for lighting and similar applications. In addition, 110V configuration models and a number of variations to accommodate different sizes and types of cables are available.

439S STEPS OF ASSEMBLY				
	1. Attach Cord Grip and Cover	2. Cut Cord (refer to directions below)	3. Remove Cord Sheath	4. Insert Stripped Cable Ends Into Terminals
	5. Tighten Terminal Screws	6. Push Cover Over Plug Assembly	7. Tighten Cord Grip	8. Fully Assembled 439S

Stripping Dimensions (mm)

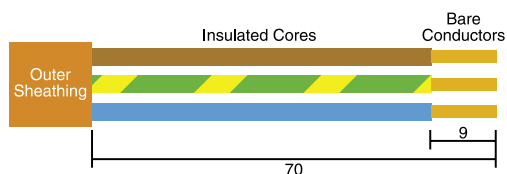

FLEXIBLE THREE-PIN PLUGS

Cat. No.	Diameter	Depth
All Products	41mm Ø	74mm
439S	Flexible Plug, 250V, 10A a.c., 8.7mm Ø cord entry size , insulated active and neutral pins, with external cord grip, suitable for 0.75mm ² and 1mm ² ordinary duty three core flexible cords.	
439SUA	Flexible Plug, 250V, 10A a.c., 8.7mm Ø cord entry size , insulated active and neutral pins, with external cord grip, suitable for 0.75mm ² and 1mm ² ordinary duty three core flexible cords (unassembled).	
439SL	Flexible Plug, 250V, 10A a.c., with round earth pin, 8.7mm Ø cord entry size , insulated active and neutral pins, suitable for 0.75mm ² and 1mm ² ordinary duty three core flexible cords.	
439SLUA	Flexible Plug, 250V, 10A a.c., with round earth pin, 8.7mm Ø cord entry size , insulated active and neutral pins, suitable for 0.75mm ² and 1mm ² ordinary duty three core flexible cords (unassembled).	
439SLHD	Flexible Plug, 250V, 10A a.c., with round earth pin, heavy duty, 10.4mm Ø cord entry size , insulated active and neutral pins, suitable for 0.75mm ² and 1mm ² heavy duty three core flexible cords.	
439SN	Flexible Plug, 250V, 10A a.c., with neon, 8.7mm Ø cord entry size , insulated active and neutral pins, suitable for 0.75mm ² and 1mm ² ordinary duty three core flexible cords.	
439SY	Flexible Plug, 250V, 10A a.c., plug for 0.75mm² two core figure 8 flexible cords , insulated active and neutral pins.	
439SYUA	Flexible Plug, 250V, 10A a.c., plug for figure 8 flex , insulated active and neutral pins, suitable for 0.75mm ² flat sheathed two core flexible cords (unassembled).	
439SZ	Flexible Plug, 250V, 10A a.c., plug for light duty flex, 6.6mm Ø cord entry size , insulated active and neutral pins, suitable for up to 0.75mm ² ordinary duty three core flexible cords.	
439SHD	Flexible Plug, 250V, 10A a.c., heavy duty, 10.4mm Ø cord entry size , insulated active and neutral pins, suitable for 1mm ² heavy duty three core flexible cords.	
439SHDUA	Flexible Plug, 250V, 10A a.c., heavy duty, 10.4mm Ø cord entry size , insulated active and neutral pins, suitable for 0.75mm ² and 1mm ² heavy duty three core flexible cords (unassembled).	
439SXHD	Flexible Plug, 250V, 10A a.c., extra heavy duty, 12mm Ø cord entry size , insulated active and neutral pins, suitable for 1.5mm ² heavy duty three core flexible cords (transparent only).	
439S15	Flexible Plug, 250V, 15A a.c., 8.7mm Ø cord entry size , insulated active and neutral pins, suitable for 1.5mm ² ordinary duty three core flexible cords.	
439S15UA	Flexible Plug, 250V, 15A a.c., 8.7mm Ø cord entry size , insulated active and neutral pins, suitable for 1.5mm ² ordinary duty three core flexible cords (unassembled).	
439S15HD	Flexible Plug, 250V, 15A a.c. , insulated active and neutral pins, heavy duty, 12mm Ø cord entry size, suitable for 1.5mm ² heavy duty three core flexible cords.	
439S15HDUA	Flexible Plug, 250V, 15A a.c., heavy duty, 12mm Ø cord entry size , insulated active and neutral pins, suitable for 1.5mm ² heavy duty three core flexible cords (unassembled).	
439/110	Flexible Plug, 110V, 10A a.c., three pins (two round active pins) , 8.7mm Ø cord entry size, suitable for up to 1mm ² ordinary duty three core flexible cords.	

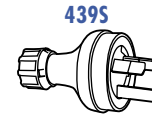

439S

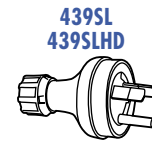

439SL
439SLHD



439SN

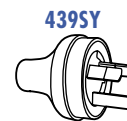

439SY

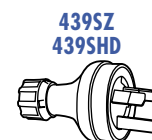

439SZ
439SHD

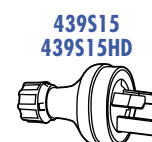

439S15
439S15HD

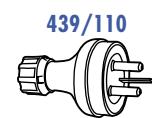

439/110

439S



439SL



439SY



439S15





439/110



FLEXIBLE PLUGS

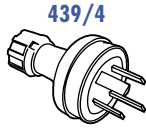

Flexible Four-Pin Plug

FLEXIBLE FOUR-PIN PLUG				
Cat. No.	Diameter	Depth		
439/4	40mm Ø	67mm		
439/4	Flexible Plug, 500V, 10A a.c., four pins, plug top to suit Cat. No. 410 surface socket. Dual live pins provide for dual switching of lighting, for energy management and for an unswitched active for emergency lighting. 8.7mm Ø cord entry size, suitable for 0.75mm ² and 1mm ² ordinary duty four core flexible cords.			

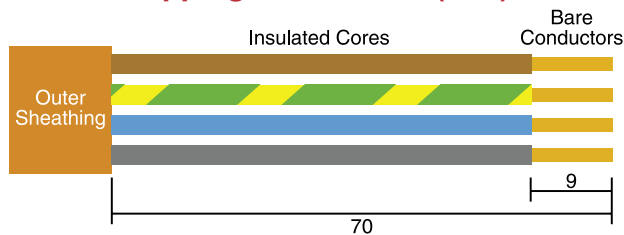
Stripping Dimensions (mm)

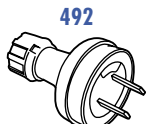

Flexible Two-Pin Plugs

FLEXIBLE TWO-PIN PLUGS				
Cat. No.	Diameter	Depth		
All Products	39mm Ø	70mm		
492	Flexible Plug, 250V, 10A a.c., two parallel pins, 8.7mm Ø cord entry size, suitable for 0.75mm ² and 1mm ² ordinary duty two core flexible cords (Note: plug generally used for 110 - 125V applications).			
492Y	Flexible Plug, 250V, 10A a.c., two parallel pins, figure 8 cord entry size, suitable for 0.75mm ² two core parallel figure 8 flexible cord (Note: plug generally used for 110 - 125V applications).			
492/32	Flexible Plug, extra low voltage (32V) 15A configuration, two polarised pins, 8.7mm Ø cord entry size, suitable for 0.75mm ² and 1mm ² ordinary duty three core flexible cords.			

Stripping Dimensions (mm)

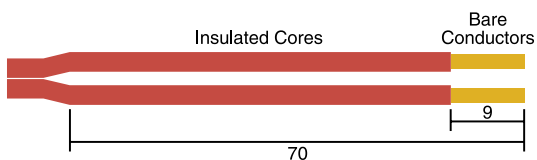

Wiring Instructions

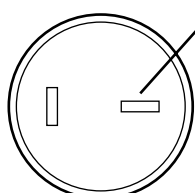
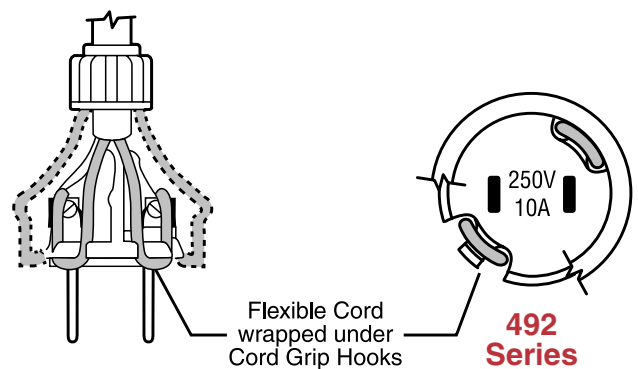

492/32

Note: Where the ELV supply is referenced to Earth, the radial pin should be the Earth pin. Outside of these situations it is recommended to consider the radial pin as Neutral and the remaining pin as Active, although these connections can be reversed.

QUICK CONNECT PLUGS

An innovative range of quick connect plug tops in 10A, 15A and 20A in three pin and 10A in four pin configurations are available. All are made from transparent impact resistant polycarbonate. The 1439 Series utilises a two piece design which assembles quickly and easily with two screws. The cable is automatically clamped as the two pieces are assembled. For added safety the 10A + 15A versions of this range have insulated live pins.

Three-Pin Models

QUICK CONNECT PLUGS (THREE PIN MODELS)				
Cat. No.	Diameter	Depth	1439S	1439S
1439S,1439SHD	41mm Ø	74mm		
1439S15	41mm Ø	74mm	1439S15	
1439/20	41mm Ø	74mm	1439/20	
1439S	Quick Connect Plug, 250V, 10A a.c., insulated active and neutral pins, 8mm Ø cord entry size, suitable for up to 1mm² ordinary duty three core flexible cords.			
1439SHD	Quick Connect Plug, 250V, 10A a.c., insulated active and neutral pins, 11mm Ø cord entry size, suitable for up to 1mm² heavy duty three core flexible cords.			
1439S15	Quick Connect Plug, 250V, 15A a.c., insulated active and neutral pins, 11mm Ø cord entry size, suitable for 1.5mm² ordinary and heavy duty three core flexible cords.			
1439/20	Quick Connect Plug, 250V, 20A a.c., three pins, 11mm Ø cord entry size, suitable for 2.5mm² ordinary duty three core flexible cords.			

1439S

STEPS OF ASSEMBLY



1. Thread Cord Through Housing



2. Cut Cable (refer to directions)



3. Remove Cable Sheath



4. Strip Cable Ends and Terminate



5. Slip Cover On and Tighten Screws



6. Fully Assembled 1439S

Stripping Dimensions (mm)

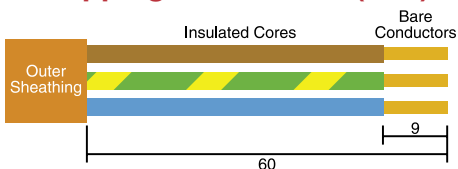

Wiring Instructions

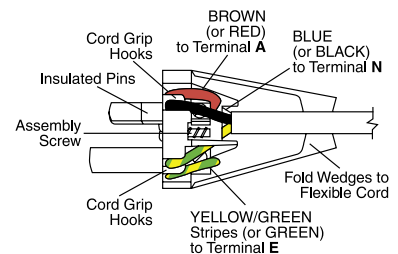

Four-Pin Model

QUICK CONNECT PLUG (FOUR PIN MODELS)				
Cat. No.	Diameter	Depth	1439/4P	1439/4P
1439/4P	47mm Ø	71mm		
1439/4P	Quick Connect Plug, 500V, 10A a.c., plug top to suit Cat. No. 413/4P and 414/4P surface sockets. Dual live pins provide for dual switching of lighting, for energy management and for an unswitched active for emergency lighting. 10.5mm Ø cord entry size, suitable for up to 1mm² heavy duty or 1.5mm² ordinary duty four core flexible cords.			

RIGID PLASTIC PLUGS & APPLIANCE PLUGS

Rigid Three-Pin Model

RIGID PLASTIC PLUG (THREE PIN MODEL)			
Cat. No.	Diameter	Depth	
425HD	44mm Ø	70mm	
425HD	Rigid Plastic Plug, 250V, 20A a.c., three pins, 14.3mm ø cord entry size, suitable for 2.5mm ² ordinary and heavy duty three core flexible cords.		

Appliance Plugs

The Clipsal Range includes a number of domestic appliance plugs, as well as international plugs and couplers. Some products are suitable for applications up to 120°C, such as jugs, kettles and similar appliances. Others are only suitable for applications up to 65°C, such as computers and similar electronic equipment.

APPLIANCE PLUGS			
Cat. No.	Length	Width	Depth
464	100mm	38mm	22mm
465, 465C, 465C2	85mm	26.5mm	18mm
464	Domestic Appliance Plug, 250V, 7.5A a.c. two pin with earth side contact, for conditions not exceeding 120°C (suitable for 0.5mm ² , 3 core, cotton covered ordinary duty flexible cord).		
465	International Three Pin Appliance Coupler (plug) with keyway, 250V, 7.5A a.c., for conditions not exceeding 120°C (suitable for 1mm ² , 3 core, ordinary duty flexible cord). Also tested to BS4491.		
465C	International Three Pin Appliance Coupler (plug), 250V, 10A a.c., for conditions not exceeding 65°C (suitable for 1mm ² , 3 core, ordinary duty flexible cord). Also tested to BS4491.		
465C2	International Two Pin Appliance Coupler (plug), 250V, 10A a.c., no earth contact, for conditions not exceeding 65°C (suitable for 1mm ² , 2 core, ordinary duty flexible cord). Also tested to BS4491.		

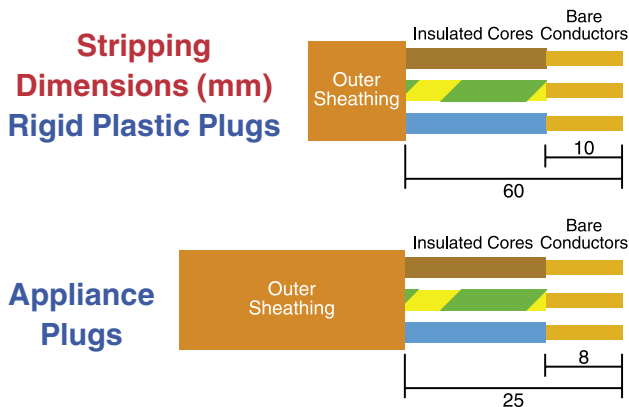







CLOCK POINT PLUGS & SIDE ENTRY PLUGS

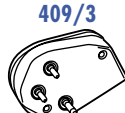

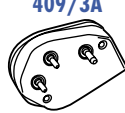

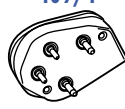

Clock Point Plugs

Clock Point Plugs are for use with recessed clock point sockets. The sockets on Page 34 were originally developed to provide semi permanent connection of electric clocks, but can also be used for other low drain appliances. The plugs fit down into the recessed sockets flush with the wall surface. Three and four pin configurations are available. All are rated at 250V, 5A.

CLOCK POINT PLUGS					
Cat. No.	Length	Width	Depth		
All Products	48mm	35mm	16.5mm (29mm incl.pins)		
409/3	Clock Point Plug, three pin, accommodates 0.75mm ² flexible cords (suits 408/3 socket).				
409/3A	Clock Point Plug, three pin, alternative configuration, accommodates 0.75mm ² flexible cords (suits 408/3A socket).				
409/4	Clock Point Plug, four pin, accommodates 0.75mm ² flexible cords (suits 408/4 socket).				

Side Entry Plugs

When socket outlets are awkwardly positioned behind fridges or other appliances, a side entry plug is the perfect solution. These three pin plugs take up very little space and are more unobtrusive than rear entry models. They come in a choice of 10A or 15A models and most are available in White Electric, Black, Grey and Transparent.

SIDE ENTRY PLUGS					
Cat. No.	Length	Width	Depth		
All Products	54mm	53mm	44mm		
418S	Side Entry Plug, 250V, 10A a.c., insulated active and neutral pins, suitable for 1mm ² ordinary duty or light duty three core flexible cords.				
418SL	Side Entry Plug, 250V, 10A a.c., insulated active and neutral pins, round earth, suitable for 1mm ² ordinary duty or light duty three core flexible cords.				
418S15	Side Entry Plug, 250V, 15A a.c., insulated active and neutral pins, suitable for 1.5mm ² ordinary duty three core flexible cords.				

418S

STEPS OF ASSEMBLY



1. Insert Grommet and Cut Cable (refer to directions)



2. Insert Stripped Cable Ends Into Terminals. Tighten Screws.



3. Insert Grommet Into Plug Base



4. Snap Back Onto Assembly. Tighten Screws.



5. Fully Assembled 418S

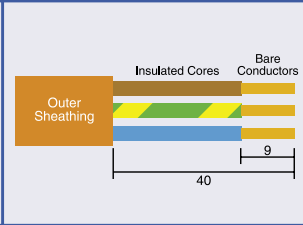

Stripping Dimensions (mm)

Outer Sheathing: 40mm
Insulated Cores: 9mm
Bare Conductors: 9mm

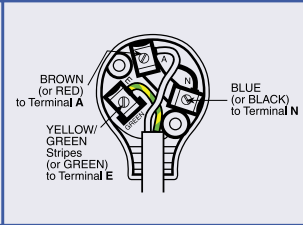





Wiring Instructions

BROWN (or RED) to Terminal A
BLUE (or BLACK) to Terminal N
YELLOW/GREEN Stripes (or GREEN) to Terminal E

SAFETY PLUG

Safety Plug

Socket outlets and sockets can present a real hazard around children, as their curiosity often leads them to insert objects into sockets. The following products provide peace of mind when children are left unattended.











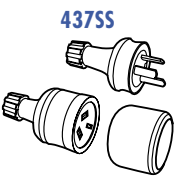

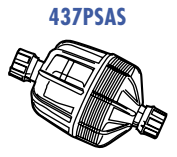
SAFETY PLUG			417	
Cat. No.	Diameter	Depth	417	
417	35mm Ø	25mm		
417	All insulated safety plug , blank plugs which insert into 10A, 15A and 20A sockets and prevent access to live parts.			

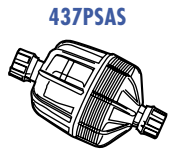

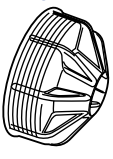
PLUG & SOCKET SET COUPLINGS

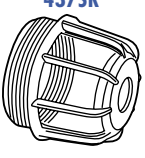
Extension cable disconnections can be annoying and hazardous. Clipsal threaded couplings prevent separation by locking the plug and socket firmly in place. They also keep Clipsal 439 and 438 Series plug and socket connections weatherprotected. These couplings suit most plug/socket connections.











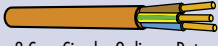





























They are moulded in bright orange impact resistant transparent polycarbonate.

PLUG & SOCKET SET COUPLINGS				
Cat. No.	Diameter	Depth		
437SS	49mm Ø	116mm		
437PSAS	66mm Ø	110mm		
437PS	64mm Ø	56mm		
437PR	62mm Ø	33mm		
437SR	66mm Ø	56mm		
437P	53mm Ø	38mm		
437S	64mm Ø	40mm		
437SS	Cord Extension Socket & Plug, 250V, 10A, three insulated pins, with rubber connector, unbreakable, recommended for 1mm² ordinary duty three core flexible cords.			
437PSAS	Cord Extension Socket & Plug, 250V, 10A, three insulated pins, with weatherprotected threaded coupling, unbreakable, recommended for 1mm² ordinary duty three core flexible cord.			
437PS	Plug & Socket Threaded Coupling Set, weatherprotected, male and female threads 2" B.S.P. (11 T.P.I.) (437PR & 437SR).			
437PR	Plug Top Coupling Ring, weatherprotected, female threads 2" B.S.P (11 T.P.I.), suits 439 Series, 437R Coupling Ring, Single Phase 56S0310 Series sockets, 56C310 Series combinations and SS15 Series suspension switch sockets.			
437SR	Cord Extension Socket Coupling Ring, weatherprotected, male thread 2" B.S.P. (11 T.P.I.), suits 438 Series & 437PR Coupling Ring.			
437P	Plug Coupling Ring, weatherprotected, suits 437S socket coupling.			
437S	Cord Extension Socket Coupling Ring, weatherprotected, suits 437P Plug Coupling only.			



Installation example using 437PS

CORD EXTENSION SOCKET SELECTION CHART

	FLEXIBLE CORDS	DIMENSIONS (AS3191)	RECOMMENDED CORD EXTENSION SOCKETS
0.75mm ² (24/0.2) 7.5A	 3-Core Circular Ordinary Duty	7mm Ø	 438  438UA  438L  438LUA  438/110  438N
	 3-Core Circular Heavy Duty	9mm Ø	 438HD  438HDUA
1mm ² (32/0.2) 10A	 2-Core Circular Ordinary Duty	7mm Ø	 438/2
	 3-Core Circular Ordinary Duty	7.4mm Ø	 438  438UA  438L  438LUA  438/110  1438
	 3-Core Circular Heavy Duty	9.5mm Ø	 438HD  438HDUA  1438HD
1.5mm ² (30/0.25) 15A	 2-Core Circular Ordinary Duty	7.9mm Ø	 438/32
	 3-Core Circular Ordinary Duty	8.6mm Ø	 438/15  438/15UA  438S15
	 3-Core Circular Heavy Duty	10.5mm Ø	 438XHD  438XHDUA  438/15HD  438/15HDUA  438/15  438/15UA  438S15  1438/15
2.5mm ² (50/0.25) 20A	 3-Core Circular Ordinary Duty	10.6mm Ø	 438/20  438/20HD



FLEXIBLE CORD EXTENSION SOCKETS

Flexible yet unbreakable, these extension sockets feature an internal cord anchor and external cord grip to keep cords firmly in place. They are available in 10A, 15A and 20A configurations with covers and cord grips to suit various cable sizes. An instant external visual check for correct connections is provided. Models are available in 2 and 3 pin configurations. Although the standard colour for all models is Grey, they are also available in Transparent, White Electric, Black and Electric Orange, unless otherwise indicated.

FLEXIBLE CORD EXTENSION SOCKETS (TWO PIN MODELS)		
Cat. No.	Diameter	Depth
All Products	43mm Ø	71mm
438/2	Flexible Cord Extension Socket, 250V, 10A a.c. , two parallel pins, 8.5mm Ø nominal cord entry, suitable for 1mm ² ordinary duty flexible cord	
438/32	Flexible Cord Extension Socket, extra low voltage, 15A , two polarised pins, 8.5mm Ø nominal cord entry, suitable for 1.5mm ² ordinary duty two core flexible cord	

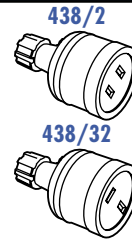

FLEXIBLE CORD EXTENSION SOCKETS (THREE PIN MODELS)		
Cat. No.	Diameter	Depth
All Products	43mm Ø	71mm
438	Flexible Cord Extension Socket, 250V, 10A a.c. , three pins, 8.5mm Ø nominal cord entry, suitable for 0.75mm ² and 1mm ² ordinary duty flexible cord	
438L	Flexible Cord Extension Socket, 250V, 10A a.c. , three pins, round earth pin version , 8.5mm Ø nominal cord entry, suitable for 1mm ² ordinary duty flexible cord	
438HD	Flexible Cord Extension Socket, 250V, 10A a.c. , three pins, heavy duty version , 10mm Ø nominal cord entry, suitable for 0.75mm ² and 1mm ² heavy duty flexible cord	
438XHD	Flexible Cord Extension Socket, 250V, 10A a.c. , three pins, extra heavy duty version , 12mm Ø nominal cord entry, suitable for 1.5mm ² heavy duty flexible cord	
438/110	Flexible Cord Extension Socket, 110V, 10A a.c. , three pins, two round active pins and a flat earth pin , 8.5mm Ø nominal cord entry, suitable for 1mm ² ordinary duty flexible cord	
438/15	Flexible Cord Extension Socket, 250V, 15A a.c. , three pins, 10mm Ø nominal cord entry, suitable for 1.5mm ² ordinary duty flexible cord	
438S15	Flexible Cord Extension Socket, 250V, 15A a.c. , three pins, 10mm Ø nominal cord entry, suitable for 1.5mm ² ordinary duty flexible cord, with 8mm shroud	
438/15HD	Flexible Cord Extension Socket, 250V, 15A a.c. , three pins, 12mm Ø nominal cord entry, suitable for 1.5mm² heavy duty flexible cord	
438/20	Flexible Cord Extension Socket, 250V, 20A a.c. , three pins, 12mm Ø nominal cord entry, suitable for 2.5mm ² ordinary duty flexible cord	

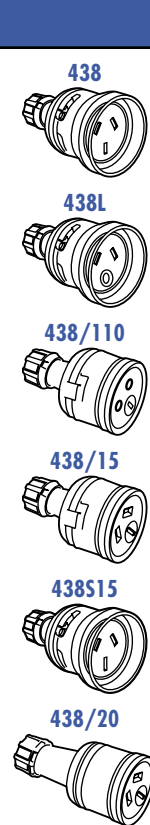

438

STEPS OF ASSEMBLY

1. Thread Cord Through Cord Grip and Housing Cover

2. Stripe Wires, Insert Into Terminals

3. Tuck Cords Into Housing

4. Insert Assembly Into Cover

5. Attach Cord Grip to Cover

6. Fully Assembled 438

Outer Sheathing

Insulated Cores

Bare Conductors





50

9

Stripping Dimensions (mm)

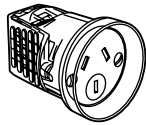
QUICK CONNECT EXTENSION SOCKETS

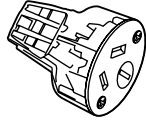
An innovative range of quick connect extension sockets in 10A and 15A configurations is also available, all made from transparent impact resistant polycarbonate. The 1438 Series utilises a two piece design which assembles quickly and easily with two screws. The cable is automatically clamped as the two pieces are assembled.

QUICK CONNECT EXTENSION SOCKETS				
Cat. No.	Diameter	Depth		
All Products	41mm Ø	62mm		
1438	Quick Connect Extension Socket, 250V, 10A a.c., 8mm Ø nominal cord entry, suitable for 1mm² ordinary duty flexible cord.			
1438HD	Quick Connect Extension Socket, 250V, 10A a.c., heavy duty version, 10.3mm Ø nominal cord entry, suitable for 1mm² heavy duty flexible cord.			
1438/15	Quick Connect Extension Socket, 250V, 15A a.c., 11mm Ø nominal cord entry, suitable for 1.5mm² heavy duty flexible cord.			

Wiring Instructions

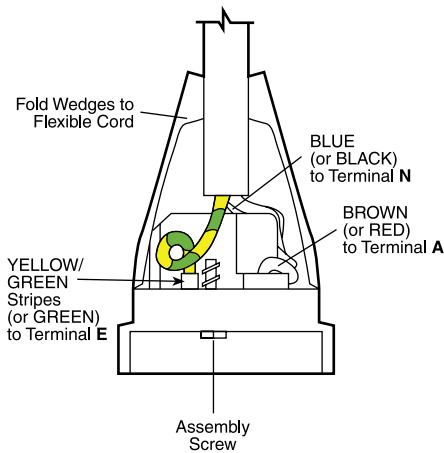

Stripping Dimensions (mm)

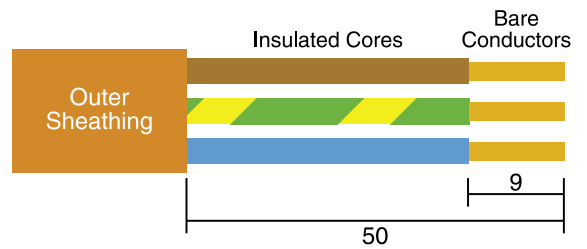

1438 STEPS OF ASSEMBLY



1. Thread Cord Through Cover



2. Strip Wires, Insert Into Terminals and Tighten Screws



3. Slip Cover Over Assembly, Tighten Screws



4. Fully Assembled 1438

Dual Adaptors

Dual adaptors are the easiest and most convenient way of turning a single socket into a double one. They are manufactured from impact resistant materials in the traditional 'tent shape' design.

DUAL ADAPTOR				460S	
Cat. No.	Length	Width	Depth	460S	
460S	72mm	41mm	40mm		
460S	Dual Adaptor, 250V, 10A a.c., three pins (White Electric only). Note: Active and Neutral pins are insulated.				



Surge Protected Plug Adaptors

Voltage surges may result from various sources, including the switching on and off of electrical loads, operating of high current equipment such as arc welders or from electrical storms. With each surge, the delicate and expensive electronic circuitry used in a wide range of appliances may degrade and in time be completely destroyed. The 463SF is a compact module designed to absorb such surges in order to keep your equipment safe.

SURGE PROTECTED PLUG ADAPTOR				463SF	
Cat. No.	Length	Width	Depth	463SF	
463SF	74mm	43mm	56mm		
463SF	Surge Protected Plug Adaptor, 250V, 10A				

SURFACE SOCKETS











Surface sockets offer a convenient way of providing power to fixed appliances, loom wiring, or for providing socket facilities on equipment for connection of ancillary items. The Clipsal Range includes surface sockets in both front and rear connection, and in two, three and four pin configurations. All comply with the requirements of relevant Australian and New Zealand Standards.

Front Connecting Surface Sockets

Older style rear cable entry front connecting sockets are still widely used in replacement or specific applications. Terminals are accessed by the removal of the front cover.

Small Base Surface Sockets

Small base sockets are available in two and three pin configurations, in White Electric and Brown.

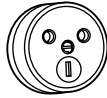

FRONT CONNECTING SURFACE SOCKETS					
Cat. No.	Diameter	Depth	Mounting Centres		
402	45mm Ø	28mm	28mm apart		
402/32, 412, 412L, 412/15, 412/110	47mm Ø	28mm	35 to 38mm apart		
402	Front Connecting Surface Socket, 250V, 10A, two parallel flat pins, 4mm live contact terminal bore to accommodate 3 x 2.5mm ² cables, suits 492 Series and 430 plugs.				
402/32	Front Connecting Surface Socket, 32V, 15A, two polarised flat pins, 4.8mm live contact terminal bore to accommodate 4 x 2.5mm ² cables, suits 492/32 plugs.				
412	Front Connecting Surface Socket, 250V, 10A, three pins, 4mm live contact terminal bore to accommodate 3 x 2.5mm ² cables & 4.8mm earth contact terminal bore to accommodate 4 x 2.5mm ² cables.				
412L	Front Connecting Surface Socket, 250V, 10A, three pins, round earth pin for lighting and other dedicated applications, 4mm live contact terminal bore to accommodate 3 x 2.5mm ² cables & 4.8mm earth contact terminal bore to accommodate 4 x 2.5mm ² cables.				
412/15	Front Connecting Surface Socket, 250V, 15A, three pins, 4mm live contact terminal bore to accommodate 3 x 2.5mm ² cables & 4.8mm earth contact terminal bore to accommodate 4 x 2.5mm ² cables.				
412/110*	Front Connecting Surface Socket, 110V, 10A, two round live pins & flat earth pin, 4mm live contact terminal bore to accommodate 3 x 2.5mm ² cables & 4.8mm earth contact terminal bore to accommodate 4 x 2.5mm ² cables.				

* A socket in this configuration is also available in the standard base format to mount on 50mm mounting accessories in White Electric and Black.

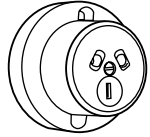

Airflow 6600R installation example using 413 Surface Socket

Standard Base Surface Socket

STANDARD BASE SURFACE SOCKET				412A110	
Cat. No.	Diameter	Depth	Mounting Centres		
412A110	65mm Ø	35mm	50mm		
412A110	Standard Base Surface Socket, 110V, 10A, two round live pins with flat earth, 4.8mm terminal bore to accommodate 4 x 2.5mm ² cables.				











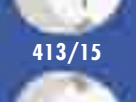
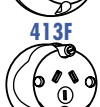

SURFACE SOCKETS

Rear Connecting Surface Sockets

The Clipsal rear connecting sockets are robust and easy to wire. All terminals are clearly marked and colour coded, have ample cable entry tear outs, and are suitable for mounting to loom wiring fixing plates, 240 Series Junction Boxes and other 50mm accessories, or direct mounting. Standard colour is White Electric.

Single Three Pin Sockets

Suitable for direct mounting, mounting onto 240 Series Junction Boxes or other 50mm accessories, or onto 411, 413FP and 413NP loom wiring plates.

REAR CONNECTING SURFACE SOCKETS (SINGLE THREE PIN)						
Cat. No.	Length	Width	Depth	Mounting Centres		
413,413/5,413/15,413F,413L,413FL	66mm Ø		46mm	50mm apart		
413QC	70mm	47mm	46mm	50mm apart		
413	Rear Connecting Surface Socket, 250V, 10A , single, three pins, terminal bores accommodate 4 x 4mm ² cables, one looping terminal (supplied complete with 413NP).					
413/5	Rear Connecting Surface Socket, 250V, 10A , single, three pins, terminal bores accommodate 4 x 4mm ² cables, two looping terminals .					
413/15	Rear Connecting Surface Socket, 250V, 15A , single, three pins, terminal bores accommodate 4 x 4mm ² cables, one looping terminal.					
413F	Rear Connecting Surface Socket, 250V, 10A , single, three pins, terminal bores accommodate 4 x 4mm ² cables, one looping terminal (complete with fast fixing nails).					
413L	Rear Connecting Surface Socket, 250V, 10A , single, three pins, round earth pin , terminal bores accommodate 4 x 4mm ² cables, one looping terminal.					
413FL	Rear Connecting Surface Socket, 250V, 10A , single, three pins, round earth pin , terminal bores accommodate 4 x 4mm ² cables, one looping terminal (complete with fast fixing nails).					
413QC	Quick Connect In Line Surface Socket, 250V, 10A , single, three pins, 1mm ² to 2.5mm ² solid/stranded to AS/NZS5000 conductor range. Can terminate up to 2 sets of Active, Neutral & Earth conductors.					

413QC STEPS OF ASSEMBLY



1. Remove Outer Sheathing of TPS Cable (46mm - Mid Connection or 70mm - End Connection)



2. Lay Cable Into Terminal Paths (Mid Cable) or Place Tails Into Cavities (End Cable)



3. Close Lid and Squeeze With Pliers



4. Fully Assembled 413QC. Use a Screwdriver to Reopen if Needed.



Wiring Instructions

1. Insulation clamping ribs hold the wire securely and isolate the contact area from vibration and mechanical stress.
2. Contact tags at 45° across the axis of the wire ensure a solid, gas-tight connection.
3. Unique axial and torsional restoring forces maintain a durable connection and isolates the contact area from vibration and mechanical stress.

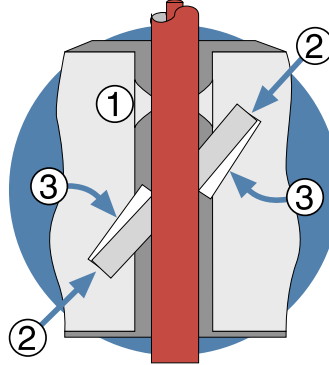

More information is available in our **Quick Connect brochure** (Brochure O/N 3649)

Twin Three Pin Sockets

Suitable for direct mounting onto 240 Series Junction Boxes, other 50mm accessories, or onto 411, 413FP and 413NP loom wiring plates.

REAR CONNECTING SURFACE SOCKETS (TWIN THREE PIN)				
Cat. No.	Length	Width	Depth	Mounting Centres
All Products	72mm	65mm	63mm	50mm apart
414	Rear Connecting Surface Socket, 250V, 10A, twin, three pins, terminal bores accommodate 4 x 4mm ² cables, one looping terminal (supplied complete with 413NP).			
414L	Rear Connecting Surface Socket, 250V, 10A, twin, three pins, round earth pin, terminal bores accommodate 4 x 4mm ² cables, one looping terminal.			

414

414L

414

414L

SURFACE SOCKETS

Four Pin Sockets

Four pin (dual active) sockets are ideal for loom wiring applications where an additional active is required for energy management or emergency lighting applications. Suitable for direct mounting onto 240 Series Junction Boxes or other 50mm accessories, or onto 411, 413FP and 413NP loom wiring plates (except 414/4P).

REAR CONNECTING SURFACE SOCKETS (FOUR PIN)				
Cat. No.	Length	Width	Depth	Mounting Centres
410	65mm Ø		38mm	50mm apart
413/4P	66mm Ø		46mm	50mm apart
414/4P	112mm	65mm	46mm	50mm apart
410	Rear Connecting Surface Socket, 500V, 10A a.c., single, four pins, terminal bores accommodate 4 x 4mm ² cables, one looping terminal.			
413/4P	Rear Connecting Surface Socket, 250/440V, 10A a.c., single, four pins, terminal bores accommodate 4 x 4mm ² cables, one looping terminal.			
414/4P	Rear Connecting Surface Socket, 250/440V, 10A a.c., twin, four pins, terminal bores accommodate 4 x 4mm ² cables, one looping terminal (supplied with 413FP fixing plate).			



410

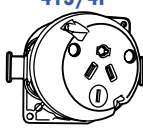

413/4P



414/4P



410



413/4P



414/4P

Fixing Plates for Loom Wiring

Three options are available for use with loom wiring systems. All are suitable for product with 50mm mounting centres.

FIXING PLATES FOR LOOM WIRING				
Cat. No.	Length	Width	Depth	Mounting Centres
411	155mm	70mm	34mm	50mm apart
413FP	139mm	80mm	17mm	50mm, 55mm & 84mm
413NP, 413NPQC	73mm (incl. tabs - 95mm)	73mm	12mm	50mm (clips) 90mm (holes)
411	Loom Wiring Fixing Plate, accessories are screw fixed to fixing plate providing the clamping of the cables, six cable entry cut outs (not suitable for 414/4P).			
413FP	Loom Wiring Fixing Plate, accessories clip on to fixing plate, 25mm cut out in rear of plate, facility for the use of cable ties for cable clamping.			
413NP	Loom Wiring Fixing Plate, for 410, 413 and 414 products, for the use of cable ties for cable clamping (not suitable for 414/4P).			
413NPQC	Loom Wiring Fixing Plate, for 413QC Series, for the use of cable ties for cable clamping (not suitable for 414/4P).			



411

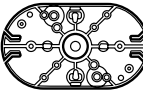

413FP

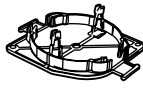

413NP

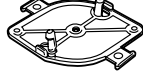

413NPQC



411



413FP



413NP



413NPQC

We've nailed it!



The new and improved **413 Nail plate** is finally here. Compared to its predecessor the new **413NP** has many improved features and functions. It's easier, clearer and roomier. It has also been quality tested in heat stressed conditions and redesigned to fit more than just the 413 Socket outlet.

After years of wrenching the tops off of the 413 nail plates, the new design allows an easy method to release the socket outlet.

The raised walls (8mm) of the new nail plate provide a greater space to wire within.

The moulded plastic nail plate is made with a clear polycarbonate to improve the visibility of the cable connections within the socket outlet.



STEP 1: Insert a flat screwdriver into the clips holding socket outlet.

STEP 2: Twist the screwdriver anti-clockwise and push.



STEP 3: Insert screwdriver in the other clip and repeat Steps 1 & 2.



FLUSH SOCKETS

Clock Points

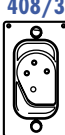
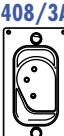
These recessed sockets were originally developed to provide semi permanent connection of electric clocks, but are also used for other low drain appliances. The sockets sit flush with the wall surface, out of sight even with the plug in place. Three and four pin configurations are available, all of which are rated at 250V, 5A.

CLOCK POINTS				
Cat. No.	Length	Width	Depth	Mounting Centres
All Products	106mm	59mm	30mm	84mm apart
408/3	Clock Point Socket, three pins , terminal bores accommodate 4 x 2.5mm ² cables, suits 409/3 plug.			
408/3A	Clock Point Socket, three pins, alternative configuration , terminal bores accommodate 4 x 2.5mm ² cables, suits 409/3A plug.			
408/4	Clock Point Socket, four pins , terminal bores accommodate 4 x 2.5mm ² cables, suits 409/4 plug.			

















Escutcheon Plate Sockets (American Standard Pattern)

These older style flush sockets are still used widely in the replacement market, as well as in various types of equipment. They are available in two pin and three pin configurations and in 10A and 15A versions in White Electric and Brown.

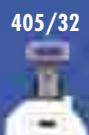
ESCUTCHEON PLATE SOCKETS (AMERICAN STANDARD PATTERN)				
Cat. No.	Length	Width	Depth	Mounting Centres
405	94mm	42mm	23mm	84mm apart
405/32	94mm	42mm	23mm	84mm apart
415, 415L, 415/15, 415/110	94mm	42mm	27mm	84mm apart
405	Escutcheon Plate Socket, 250V, 10A a.c., two parallel flat pins , live contact terminals accommodate 3 x 2.5mm ² cables.			
405/32	Escutcheon Plate Socket, 32V, 15A a.c., two polarised flat pins , live contact terminals accommodate 3 x 2.5mm ² cables.			
415	Escutcheon Plate Socket, 250V, 10A, a.c., three pins , live contact terminals accommodate 3 x 2.5mm ² cables & earth contact terminal accommodates 4 x 4mm ² cables.			
415L	Escutcheon Plate Socket, 250V, 10A, a.c., three pins, round earth pin , live contact terminals accommodate 3 x 2.5mm ² cables & earth contact terminal accommodates 4 x 4mm ² cables.			
415/15	Escutcheon Plate Socket, 250V, 15A, a.c., three pins , live contact terminals accommodate 3 x 2.5mm ² cables & earth contact terminal accommodates 4 x 4mm ² cables.			
415/110	Escutcheon Plate Socket, 110V, 10A a.c., two round live pins & flat earth pin , live contact terminals accommodate 3 x 2.5mm ² cables & earth contact terminal accommodates 4 x 4mm ² cables.			

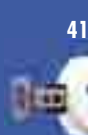
* To suit 36mm aperture.



415 Escutcheon Socket mounted into 321R Escutcheon Plate

Flush Socket Moulded Escutcheon Plates

A range of moulded escutcheon plates are still available to suit 405 and 415 Series mechanisms as well as 320 Series switches. They are available in White Electric only.

FLUSH SOCKET MOULDED ESCUTCHEON PLATES				
Cat. No.	Length	Width	Depth	Mounting Centres
321,321R	115mm	70mm	7mm	60mm
322/1R	115mm	115mm	7mm	60mm x 46mm
321	Flush Socket Moulded Escutcheon Plate, suits 320 Series flush switch mechanism.			
321R	Flush Socket Moulded Escutcheon Plate, suits 415 Series single socket mechanism.			
322/1R	Flush Socket Moulded Escutcheon Plate, suits one 320 Series switch and one flush socket.			

321
321R
322/1R

321
321R
322/1R

Cooker Socket Outlet and Plug

The cooker socket outlet and plug are used so that the stove in a new home can be plugged in by the end user at the last stages of development rather than hard wired by the electrician. This provides additional security for your appliance, preventing theft during your home's development. It also means that the stove can be unplugged and cleaned thoroughly.

COOKER SOCKET OUTLET & PLUG				
Cat. No.	Length	Width	Depth	Mounting Centres
800CL	1.8m	N/A	N/A	N/A
31VCS	115mm	73mm	11mm	84mm apart
800CL	Plug/Lead complete with 3-pin plug, 1.8m, 4mm ² conductors, 250V/32A.			
31VCS	3 Pin Cooker Socket on standard plate, 250V/32A (suits 800CL).			
2031VCS	3 Pin Cooker Socket on 2000 Series plate, 250V/32A (suits 800CL).			

800CL
31VCS
2031VCS

800CL
31VCS
2031VCS



More information is available in our **Cooker Switch brochure** (Brochure O/N 5714)



FLUSH SOCKETS

10 Series Flush Mechanisms - Automatically Switched

These are more modern versions of the 405/415 Series incorporating single or double pole automatic switching suitable for mounting into wall boxes and behind panels in various types of equipment. They are available in various three pin configurations.

10 SERIES FLUSH MECHANISMS - AUTOMATICALLY SWITCHED				
Cat. No.	Length	Width	Depth	Mounting Centres
All Products	94mm	42mm	Base projection 25mm	84mm apart (cover plate mounting centres - 60mm apart)
10M	Automatically Switched Flush Mechanism, 250V, 10A, terminal bores accommodate 4 x 2.5mm ² cables (available in Brown, Grey and White Electric).			
10MD	Automatically Switched Flush Mechanism, 250V, 10A, double pole, terminal bores accommodate 4 x 2.5mm ² cables (available in Brown, Grey and White Electric).			
10MDS	Automatically Switched Flush Mechanism, 250V, 10A, double pole, with safety shutter, terminal bores accommodate 4 x 2.5mm ² cables (Black, Brown and White Electric).			
10MD15S	Automatically Switched Flush Mechanism, 250V, 15A, double pole, with safety shutter, terminal bores accommodate 4 x 2.5mm ² cables (available in White Electric).			
10MDL	Automatically Switched Flush Mechanism, 250V, 10A, double pole, round earth pin, terminal bores accommodate 4 x 2.5mm ² cables (available in White Electric).			
10MDLS	Automatically Switched Flush Mechanism, 250V, 10A, double pole, round earth pin, with safety shutter, terminal bores accommodate 4 x 2.5mm ² cables (available in White Electric).			

10M
10MD15S
10MDL

10M
10MD15S
10MDL

415MP SERIES FLUSH MECHANISMS - UNSWITCHED				
Cat. No.	Length	Width	Depth	
All Products	45mm	42mm	Base projection 25mm	
415MP	A	Unswitched Panel Mounted Socket, 250V, 10A (available in Black and White Electric).		
415MP15	A	Unswitched Panel Mounted Socket, 250V, 15A (available in Black and White Electric).		
415MPL	B	Unswitched Panel Mounted Socket, 250V, 10A, with round earth for lighting (available in Black and White Electric).		

415MP
415MPL

415MP
415MPL

* Plate cutout for socket is 36mm

* Minimum clearance for base is 43mm x 30mm

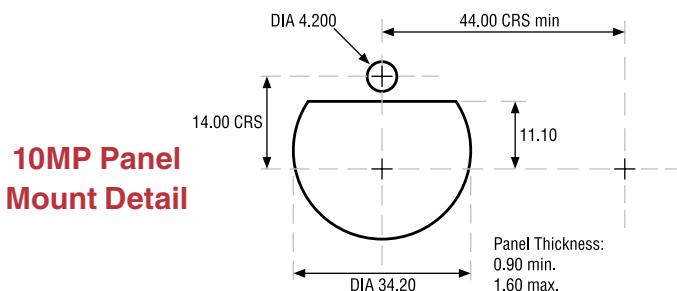

10 Series Special Purpose Mechanisms

Variations of the 10 Series are also available to fit various manufacturer's products, mainly in the protective enclosure field. Electrical, base detail and terminal detail are the same as 10 Series products.

10 Series Less Bracket

All the 10 Series Mechanisms are available less mounting brackets. The overall dimensions become 60mm x 42mm x 24mm. Add 'LB' to 10 Series Catalogue Number.

G10 Series

A limited range of 10 Series sockets with an alternative front moulding to suit GEC compact floor outlet and other similar products. All products have safety shutters.

G10 SERIES MECHANISMS			
Cat. No.	Length	Width	Depth
G10MDS	46mm	46mm	Base projection 26mm
G10MDS	Automatically Switched Mechanism, 250V, 10A, double pole, with safety shutter, suits GEC compact floor outlets.		

G10MDS

G10MDS

G10F Series

A limited range of 10 Series sockets with an alternative front moulding to suit GEC AF Series floor outlet and other similar products are available. All products have safety shutters.

G10F SERIES MECHANISMS			
Cat. No.	Diameter	Depth	Mounting Centres
All Products	74mm Ø	Base projection - 26mm	64mm apart
G10FMDS	Automatically Switched Mechanism, 250V, 10A, double pole, with safety shutter, suits GEC AF Series floor outlets.		
G10FMDLS	Automatically Switched Mechanism, 250V, 10A, double pole, round earth, with safety shutter, suits GEC AF Series floor outlets.		
G10FMD15S	Automatically Switched Mechanism, 250V, 15A, double pole, with safety shutter, suits GEC AF Series floor outlets.		

G10FMDS

G10FMDLS

G10FMD15S

G10FMDS

G10FMDLS

G10FMD15S

* Cut out 50mm Ø to clear base

Rear Connecting Flush Sockets

The 426 Series flush sockets provide an ideal way of mounting a socket onto a 240 Series conduit box and other similar accessories. The standard colour is White Electric.

REAR CONNECTING FLUSH SOCKETS			
Cat. No.	Diameter	Depth	Mounting Centres
All Products	66mm Ø	24mm	50mm apart
426	Rear connecting Flush Socket, 250V, 10A, three pins, terminal bores accommodate 4 x 2.5mm² cables.		
426L	Rear Connecting Flush Socket, 250V, 10A, three pins, round earth pin, terminal bores accommodate 4 x 2.5mm² cables.		
426/15	Rear connecting Flush Socket, 250V, 15A, three pins, terminal bores accommodate 4 x 2.5mm² cables.		

426

426L

426/15

426

426L





426/15

FLUSH SOCKETS

Skirting Duct.Sockets

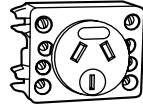
The 12M and 17M Series of skirting duct sockets were developed as a result of the extensive use of skirting duct in commercial fit outs. These sockets have easy loop in loop out terminals allowing connections to be made with the sockets fitted into the duct. If a suitable duct extrusion is used, an earth contact can be engaged with an extrusion rib to fulfil the wiring rules requirements for localised earthing of the duct.

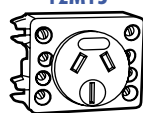
The terminal design also allows additional outlets to be cut in to an existing cable run without the need for additional cable. Skirting Duct Sockets are available in Black, White Electric and Red.

AUTOMATICALLY SWITCHED SKIRTING DUCT SOCKETS					
Cat. No.	Length	Width	Depth	12M	12M
All Products	63mm	43mm	29mm (depth behind panel - 24mm)		
12M	Automatically Switched Skirting Duct Socket, 250V, 10A , terminal bores accommodate 4 x 2.5mm ² cables.			12M15	12M15
12M15	Automatically Switched Skirting Duct Socket, 250V, 15A , terminal bores accommodate 4 x 2.5mm ² cables.				

* **Note:** mounting holes are second holes up from the bottom.

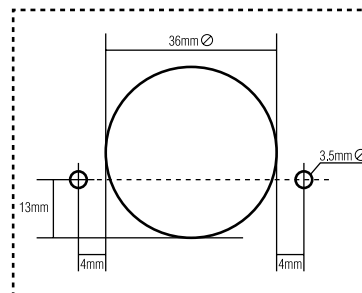

12M Cutout Template



Screws must be at least 15mm long with countersunk heads and fastened with nuts

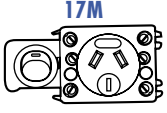

MANUALLY SWITCHED SKIRTING DUCT SOCKETS

Cat. No.	Length	Width	Depth		
17M	90mm	43mm	29mm (depth behind panel - 24mm)		
17M	Manually Switched Skirting Duct Socket, 250V, 10A , terminal bores accommodate 4 x 2.5mm ² cables.				

* **Note:** mounting holes are second holes up from the bottom.

17M Cutout Template

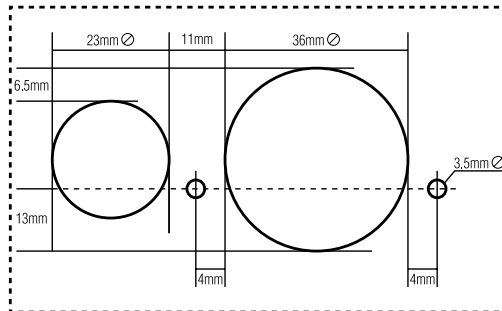









Screws must be at least 15mm long with countersunk heads and fastened with nuts

Inlet Sockets

Flush Inlet Sockets are an ideal way to supply power to cabinet type portable equipment. They are available in 10A and 15A, with or without a terminal cover. If a rear terminal cover is required, order 435A (10A) or 435A15 (15A).

The 10A versions will accept shrouded extension sockets (438). Available only in black.

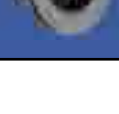
INLET SOCKETS					
Cat. No.	Diameter	Depth	Mounting Centres		
435, 435L, 435/110	85mm Ø	Base projection - 36mm	70mm apart		
435A, 435A15	85mm Ø	Base projection - 41mm	70mm apart		
435	Inlet Socket, 250V, 10A , terminal bores accommodate 3 x 2.5mm ² cables.				
435L	Inlet Socket, 250V, 10A, round earth , terminal bores accommodate 3 x 2.5mm ² cables.				
435A	Inlet Socket, 250V, 10A, with rear terminal cover , terminal bores accommodate 3 x 2.5mm ² cables.				
435A15	Inlet Socket, 250V, 15A , with terminal cover, terminal bores accommodate 3 x 2.5mm ² cables.				
435/110	Inlet Socket, 110V, 10A, two round live pins and a flat earth , terminal bores accommodate 3 x 2.5mm ² cables.				

WEATHERPROOF INLETS

Weatherproof Inlet

The 435VF15 has been the standard in the caravan and portable building industry for many years. It comes complete with a weatherprotected gasket in standard colours of White and Black.

Note: The 435VF15 Series will soon be superseded by the 435VFS15 Series. The 435VFS15 model has insulated safety pins to prevent accidental electrical contact and a recess placed in the inlet to allow the acceptance of a 15A shrouded female socket (Cat No. 438S15). Both the 435VFS15 and 415VF series have an improved cover flap that will now remain open whilst the user is plugging in plugs and sockets.

WEATHERPROOF INLET SOCKET & SPACER BLOCK				
Cat. No.	Length	Width	Depth	Mounting Centres
435VF15*	89mm	76mm	Base projection - 41mm	70mm x 54mm
435VFS15	101mm	80mm	37mm	76mm x 65mm
435VFS15FLAP	108mm	80mm	28mm	N/A
435VFM*	89mm	76mm	13mm	70mm x 54mm
435VFSM	101mm	80mm	12mm	76mm x 65mm
435VF15*	Weatherproof Inlet Socket, 250V, 15A, IP43 rating, terminal bores accommodate 3 x 2.5mm² cables.			
435VFS15	Weatherproof Inlet Socket, 250V, 15A, insulated active and neutral pins, IP34 rating, terminal bores accommodate 3 x 2.5mm² cables, includes terminal shroud.			
435VFS15FLAP	Replacement Flap for 435VFS15.			
435VFM*	Spacer block for mounting 435VF15 and 10DWP.			
435VFSM	Mounting Flange for 415VF & 435VF15 Series (available in White Electric only).			

* To be phased out and replaced with 435VFS Series



Stripping Dimensions (mm)

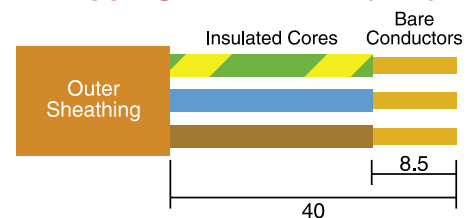

Wiring Instructions

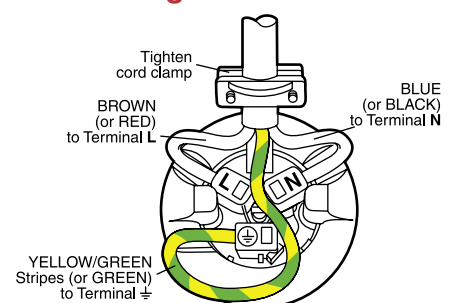

Weatherproof Flush Outlets

The companion to the 435VF15 Series is the 10DWP Flush Weatherproof outlet, which is widely used in the caravan industry and in similar applications. Available in White Electric & Black.

Note: The 10DWP Series will soon be superseded by the 415VF Series.

WEATHERPROOF FLUSH OUTLET				
Cat. No.	Length	Width	Depth	Mounting Centres
10DWP, 10DWP15	93mm	82mm	Base projection - 26mm	70mm x 54mm
415VF, 415VF15	101mm	80mm	38mm	76mm x 65mm
415VFFLAP	108mm	80mm	28mm	N/A
435VFSM	101mm	80mm	12mm	76mm x 65mm
10DWP	Weatherproof Flush Outlet, 250V, 10A, double pole, IP44 rating, terminal bores accommodate 4 x 2.5mm ² cables.			
10DWP15	Weatherproof Flush Outlet, 250V, 15A, double pole, IP44 rating, terminal bores accommodate 4 x 2.5mm ² cables.			
*415VF	Weatherproof Caravan Outlet, 250V, 10A, IP34 rating, terminal bores accommodate 0.75mm ² to 1.5mm ² PVC insulated ordinary duty 3 core flexible cable & 1 x 2.5mm ² TPS building cable.			
*415VF15	Weatherproof Caravan Outlet, 250V, 15A, IP34 rating, terminal bores accommodate 0.75mm ² to 1.5mm ² PVC insulated ordinary duty 3 core flexible cable & 1 x 2.5mm ² TPS building cable.			
415VFFLAP	Replacement Flap for 415VF Series.			
435VFSM	Mounting Flange for 415VF Series & 435VFS15 Series.			

* 415VF Series to supersede 10DWP Series.



Stripping Dimensions (mm)

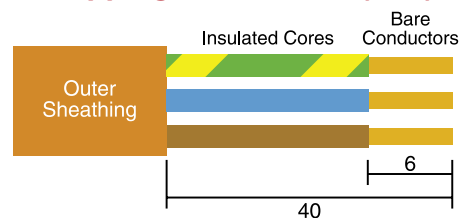

Wiring Instructions

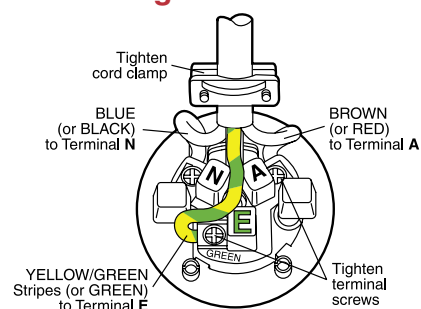

ASSOCIATED PRODUCTS

A large selection of appliance and extension leads are available. Please refer to our brochures for the latest information. **Please refer to our specialist 56 & 66 Series, Wilco Metalclad and Wilco Hi-Impact Brochures for further details.**

Industrial Plugs & Sockets

Clipsal Industrial features a comprehensive range of plugs and sockets.

Wilco Metalclad Range

All products in the Wilco 'A' Series Metalclad Range have a die cast aluminium body for greater impact resistance, light weight and corrosion resistance, for use in the harshest environments.

The modular design of the range allows components to be installed in a choice of configurations.

Clipsal 56 & 66 Series Industrial Switchgear

Available for a wide variety of pin configurations and with a minimum rating of IP56, 56 & 66 Series Plugs and sockets are suitable for the vast majority of industrial applications.

Chemical Resistant Orange, Resistant White and Chemical Grey versions are available.

Wilco Hi-Impact Switchgear

The Wilco brand has set the standard in the design and manufacture of plugs, sockets, switches, switched socket outlets, junction boxes and accessories for Australia's electrical industry.

The high impact resistant UV stabilised polycarbonate mouldings provide strength while being lightweight and resistant to most chemicals.



PLUGS, SOCKETS & ADAPTORS PRODUCT LISTING

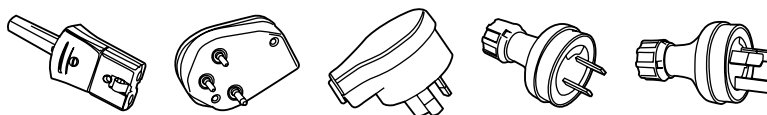

APPLIANCE PLUGS						
Cat No	Description	Length	Width	Depth	Mounting Ctrs	PAGES
464	Domestic Appliance Plug, 250V, 7.5A a.c. two pin with earth side contact.	100mm	38mm	22mm	N/A	20
465	International Three Pin Appliance Coupler (plug) with keyway, 250V, 7.5A a.c.	85mm	26.5mm	18mm	N/A	20
465C	International Three Pin Appliance Coupler (plug), 250V, 10A a.c.	85mm	26.5mm	18mm	N/A	20
465C2	International Two Pin Appliance Coupler (plug), 250V, 10A a.c.	85mm	26.5mm	18mm	N/A	20
CLOCK POINT PLUGS						
409/3	Clock Point Plug, three pin (suits 408/3 socket).	48mm	35mm	16.5mm (29mm incl.pins)	N/A	21
409/3A	Clock Point Plug, three pin, alternative configuration (suits 408/3A socket).	48mm	35mm	16.5mm (29mm incl.pins)	N/A	21
409/4	Clock Point Plug, four pin (suits 408/4 socket).	48mm	35mm	16.5mm (29mm incl.pins)	N/A	21
SIDE ENTRY PLUGS						
418S	Side Entry Plug, 250V, 10A a.c., insulated active and neutral pins.	54mm	53mm	44mm	N/A	21
418SL	Side Entry Plug, 250V, 10A a.c., insulated active and neutral pins.	54mm	53mm	44mm	N/A	21
418S15	Side Entry Plug, 250V, 15A a.c., insulated active and neutral pins.	54mm	53mm	44mm	N/A	21
FLEXIBLE TWO PIN PLUGS						
492	Flexible Plug, 250V, 10A a.c., two parallel pins, 8.7mm ø cord entry size.	39mm ø		70mm	N/A	18
492Y	Flexible Plug, 250V, 10A a.c., two parallel pins, figure 8 cord entry size.	39mm ø		70mm	N/A	18
492/32	Flexible Plug, 32V, 15A, two polarised pins, 8.7mm ø cord entry size.	39mm ø		70mm	N/A	18
FLEXIBLE THREE PIN PLUGS						
439S	Flexible Plug, 250V, 10A a.c. , insulated active and neutral pins, with external cord grip, 8.7mm ø cord entry size.	41mm ø	N/A	74mm	N/A	17
439SHD	Flexible Plug, 250V, 10A a.c., heavy duty , insulated active and neutral pins, 10.4mm ø cord entry size.	41mm ø	N/A	74mm	N/A	17
439SXHD	Flexible Plug, 250V, 10A a.c., extra heavy duty , insulated active and neutral pins, 12mm ø cord entry size (transparent only).	41mm ø	N/A	74mm	N/A	17
439SHDUA	Flexible Plug, 250V, 10A a.c., heavy duty , insulated active and neutral pins, 8.7mm ø cord entry size (unassembled).	41mm ø	N/A	74mm	N/A	17
439SL	Flexible Plug, 250V, 10A a.c., with round earth pin , insulated active and neutral pins, 8.7mm ø cord entry size.	41mm ø	N/A	74mm	N/A	17
439SLHD	Flexible Plug, 250V, 10A a.c., with round earth pin, heavy duty , insulated active and neutral pins, 8.7mm ø cord entry size.	41mm ø	N/A	74mm	N/A	17
439SLUA	Flexible Plug, 250V, 10A a.c., with round earth pin , insulated active and neutral pins, 8.7mm ø cord entry size (unassembled).	41mm ø	N/A	74mm	N/A	17
439SN	Flexible Plug, 250V, 10A a.c., with neon , insulated active and neutral pins, 8.7mm ø cord entry size.	41mm ø	N/A	74mm	N/A	17
439SUA	Flexible Plug, 250V, 10A a.c. , insulated active and neutral pins, with external cord grip, 8.7mm ø cord entry size (unassembled).	41mm ø	N/A	74mm	N/A	17
439SY	Flexible Plug, 250V, 10A a.c., plug for figure 8 flex , insulated active and neutral pins.	41mm ø	N/A	74mm	N/A	17
439SYUA	Flexible Plug, 250V, 10A a.c., plug for figure 8 flex (unassembled) insulated active and neutral pins.	41mm ø	N/A	74mm	N/A	17
439SZ	Flexible Plug, 250V, 10A a.c., plug for light duty flex , insulated active and neutral pins, 6.6mm ø cord entry size.	41mm ø	N/A	74mm	N/A	17
439S15	Flexible Plug, 250V, 15A a.c. , insulated active and neutral pins, 8.7mm ø cord entry size.	41mm ø	N/A	74mm	N/A	17
439S15HD	Flexible Plug, 250V, 15A a.c., heavy duty , insulated active and neutral pins, 12mm ø cord entry size.	41mm ø	N/A	74mm	N/A	17

PLUGS, SOCKETS & ADAPTORS PRODUCT LISTING

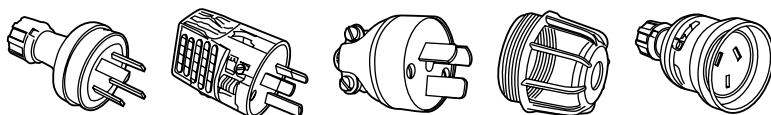

FLEXIBLE THREE PIN PLUGS (continued)

Cat No	Description	Length	Depth	Mounting Ctrs	PAGE
439S15HDDUA	Flexible Plug, 250V, 15A a.c., heavy duty , insulated active and neutral pins, 12mm \varnothing cord entry size (unassembled).	41mm \varnothing	74mm	N/A	17
439S15UA	Flexible Plug, 250V, 15A a.c. , insulated active and neutral pins, 12mm \varnothing cord entry size (unassembled).	41mm \varnothing	74mm	N/A	17
439/110	Flexible Plug, 110V, 10A a.c. , three pins (two round active pins), 8.7mm \varnothing cord entry size.	41mm \varnothing	74mm	N/A	17
FLEXIBLE FOUR PIN PLUG					
439/4	Flexible Plug, 500V, 10A a.c. , plug top to suit Cat. No. 410 surface socket.	40mm \varnothing	67mm	N/A	18
QUICK CONNECT PLUGS (THREE PIN MODELS)					
1439S	Quick Connect Plug, 250V, 10A a.c. , insulated active and neutral pins, 8mm \varnothing cord entry size.	41mm \varnothing	74mm	N/A	19
1439SHD	Quick Connect Plug, 250V, 10A a.c., heavy duty , insulated active and neutral pins, 11mm \varnothing cord entry size.	41mm \varnothing	74mm	N/A	19
1439S15	Quick Connect Plug, 250V, 15A a.c. , insulated active and neutral pins, 11mm \varnothing cord entry size.	41mm \varnothing	74mm	N/A	19
1439/20	Quick Connect Plug, 250V, 20A a.c. , three pins, 11mm \varnothing cord entry size.	41mm \varnothing	74mm	N/A	19
QUICK CONNECT PLUG (FOUR PIN MODELS)					
1439/4P	Quick Connect Plug, 500V, 10A a.c., four pin , plug top to suit Cat. No. 413/4P and 414/4P surface sockets.	47mm \varnothing	71mm	N/A	19
RIGID PLASTIC PLUG (THREE PIN MODEL)					
425HD	Rigid Plastic Plug, 250V, 20A a.c., three pins, 14.3mm \varnothing cord entry size.	44mm \varnothing	70mm	N/A	20
SAFETY SHIELD					
417	All insulated safety plug, blank plugs which insert into 10A, 15A and 20A sockets and prevent access to live parts.	35mm \varnothing	25mm	N/A	22
PLUG & SOCKET SET COUPLINGS					
437SS	Cord Extension Socket & Plug, 250V, 10A, with rubber connector , insulated active and neutral pins, unbreakable.	49mm \varnothing	116mm	N/A	23
437PSAS	Cord Extension Socket & Plug, 250V, 10A, with weatherprotected threaded coupling , insulated active and neutral pins, unbreakable.	66mm \varnothing	110mm	N/A	23
437PS	Plug & Socket Threaded Coupling, male and female threads 2" B.S.P. (11 T.P.I.) (437PR & 437SR), weatherprotected.	64mm \varnothing	56mm	N/A	23
437PR	Plug Coupling Ring, female threads 2" B.S.P. (11 T.P.I.), weatherprotected.	62mm \varnothing	33mm	N/A	23
437SR	Socket Coupling Ring, male thread 2" B.S.P. (11 T.P.I.), suits 438 Series & 437PR Coupling Ring, weatherprotected.	66mm \varnothing	56mm	N/A	23
437P	Plug Coupling Ring, suits 437S socket coupling, weatherprotected.	53mm \varnothing	38mm	N/A	23
437S	Socket Coupling Ring, suits 437P Plug Coupling only, weatherprotected.	64mm \varnothing	40mm	N/A	23
FLEXIBLE CORD EXTENSION SOCKETS (TWO PIN)					
438/2	Flexible Cord Extension Socket, 250V, 10A a.c. , two pins, 8.5mm \varnothing nominal cord entry.	43mm \varnothing	71mm	N/A	25
438/32	Flexible Cord Extension Socket, 250V, 10A a.c. , two polarised pins, 8.5mm \varnothing nominal cord entry.	43mm \varnothing	71mm	N/A	25
FLEXIBLE CORD EXTENSION SOCKETS (THREE PIN)					
438	Flexible Cord Extension Socket, 250V, 10A a.c. , three pins, 8.5mm \varnothing nominal cord entry.	43mm \varnothing	71mm	N/A	25
438L	Flexible Cord Extension Socket, 250V, 10A a.c., round earth pin version, three pins, 8.5mm \varnothing nominal cord entry.	43mm \varnothing	71mm	N/A	25
438HD	Flexible Cord Extension Socket, 250V, 10A a.c., heavy duty version, three pins, 10mm \varnothing nominal cord entry.	43mm \varnothing	71mm	N/A	25
438XHD	Flexible Cord Extension Socket, 250V, 10A a.c., extra heavy duty version, three pins, 12mm \varnothing nominal cord entry.	43mm \varnothing	71mm	N/A	25
438/110	Flexible Cord Extension Socket, 110V, 10A a.c., two round active pins and a flat earth pin , three pins, 10mm \varnothing nominal cord entry.	43mm \varnothing	71mm	N/A	25

PLUGS, SOCKETS & ADAPTORS PRODUCT LISTING

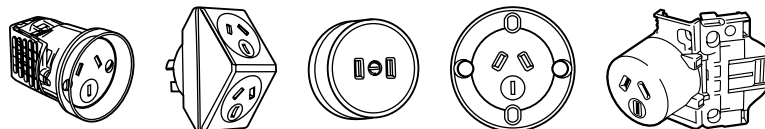

FLEXIBLE CORD EXTENSION SOCKETS (THREE PIN) (continued)						
Cat No	Description	Length	Width	Depth	Mounting Ctrs	PAGE
438/15	Flexible Cord Extension Socket, 250V, 15A a.c., three pins, 10mm ø nominal cord entry.	43mm ø		71mm	N/A	25
438S15	Flexible Cord Extension Socket, 250V, 15A a.c., three pins, 10mm ø nominal cord entry, with 8mm shroud.	43mm ø		71mm	N/A	25
438/15HD	Flexible Cord Extension Socket, 250V, 15A a.c., heavy duty, three pins, 12.8mm ø nominal cord entry.	43mm ø		71mm	N/A	25
438/20	Flexible Cord Extension Socket, 250V, 20A a.c., three pins, 12mm ø nominal cord entry.	43mm ø		71mm	N/A	25
QUICK CONNECT EXTENSION SOCKETS						
1438	Quick Connect Extension Socket, 250V, 10A a.c., 8mm ø nominal cord entry.	41mm ø		62mm	N/A	26
1438HD	Quick Connect Extension Socket, 250V, 10A a.c., heavy duty version, 10.3mm ø nominal cord entry	41mm ø		62mm	N/A	26
1438/15	Quick Connect Extension Socket, 250V, 15A a.c., 11mm ø nominal cord entry.	41mm ø		62mm	N/A	26
DUAL ADAPTOR						
460S	Dual Adaptor, 250V, 10A a.c., three pins.	72mm	41mm	40mm	N/A	27
SURGE PROTECTED PLUG ADAPTORS						
463SF	Surge Protected Plug Adaptor, 250V, 10A.	74mm	43mm	56mm	N/A	27
FRONT CONNECTING SURFACE SOCKETS						
402	Front Connecting Surface Socket, 250V, 10A, two parallel flat pins, suits 492 Series plugs.	45mm ø		28mm	28mm apart	28
402/32	Front Connecting Surface Socket, 32V, 15A, two polarised flat pins, suits 492/32 plugs.	47mm ø		28mm	35 - 38mm apart	28
412	Front Connecting Surface Socket, 250V, 10A, three pins.	47mm ø		28mm	35 - 38mm apart	28
412L	Front Connecting Surface Socket, 250V, 10A, three pins, round earth pin for lighting and other dedicated applications.	47mm ø		28mm	35 - 38mm apart	28
412/15	Front Connecting Surface Socket, 250V, 15A, three pins.	47mm ø		28mm	35 - 38mm apart	28
412/110	Front Connecting Surface Socket, 110V, 10A, two round live pins & flat earth pin.	47mm ø		28mm	35 - 38mm apart	28
STANDARD BASE SURFACE SOCKET						
412A110	Standard Base Surface Socket, 110V, 10A, two round live pins with flat earth.	65mm ø		35mm	50mm apart	29
REAR CONNECTING SURFACE SOCKETS (SINGLE THREE PIN)						
413	Rear Connecting Surface Socket, 250V, 10A, one looping terminal, single, three pins, (supplied complete with 413NP).	66mm ø		46mm	50mm apart	30
413/5	Rear Connecting Surface Socket, 250V, 10A, two looping terminals, single, three pins.	66mm ø		46mm	50mm apart	30
413/15	Rear Connecting Surface Socket, 250V, 15A, one looping terminal, single, three pins.	66mm ø		46mm	50mm apart	30
413F	Rear Connecting Surface Socket, 250V, 10A, one looping terminal, single, three pins, (complete with fast fixing nails).	66mm ø		46mm	50mm apart	30
413L	Rear Connecting Surface Socket, 250V, 10A, one looping terminal, single, three pins, round earth pin.	66mm ø		46mm	50mm apart	30
413QC	Quick Connect In Line Connecting Surface Socket, 250V, 10A, single, three pins. Can terminate up to 2 sets of Active, Neutral & Earth conductors.	70mm	47mm	46mm	50mm apart	30
REAR CONNECTING SURFACE SOCKETS (TWIN THREE PIN)						
414	Rear Connecting Surface Socket, 250V, 10A, twin, three pins.	72mm	65mm	63mm	50mm apart	31
414L	Rear Connecting Surface Socket, 250V, 10A, round earth pin, twin, three pins.	72mm	65mm	63mm	50mm apart	31

PLUGS, SOCKETS & ADAPTORS PRODUCT LISTING

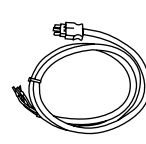
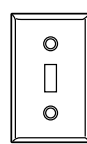
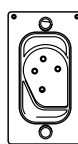

REAR CONNECTING SURFACE SOCKETS (FOUR PIN)

Cat No	Description	Length	Width	Depth	Mounting Ctrs	PAGE
410	Rear Connecting Surface Socket, 500V, 10A a.c., single, four pins.	65mm ø		38mm	50mm apart	32
413/4P	Rear Connecting Surface Socket, 250/440V, 10A a.c., single, four pins.	66mm ø		46mm	50mm apart	32
414/4P	Rear Connecting Surface Socket, 250/440V, 10A a.c., twin, four pins (supplied with 413FP fixing plate).	112mm	65mm	46mm	50mm apart	32

FIXING PLATES FOR LOOM WIRING

411	Loom Wiring Fixing Plate, accessories are screw fixed to fixing plate providing the clamping of the cords, six cord entry cut outs (not suitable for 414/4P).	155mm	70mm	34mm	50mm apart	32
413FP	Loom Wiring Fixing Plate, accessories clip on to fixing plate, 25mm cut out in rear of plate, facility for the use of cord ties for cord clamping.	139mm	80mm	17mm	50mm, 55mm & 84mm	32
413NP	Loom Wiring Fixing Plate, for 410, 413 and 414 products, for the use of cord ties for cord clamping (not suitable for 414/4P).	73mm (incl. tabs - 95mm)	73mm	12mm	50mm (clips) 90mm (holes)	32
413NPQC	Loom Wiring Fixing Plate, for 413QC Series, for the use of cord ties for cord clamping (not suitable for 414/4P).	73mm (incl. tabs - 95mm)	73mm	12mm	50mm (clips) 90mm (holes)	32

CLOCK POINTS

408/3	Clock Point Socket, three pins, suits 409/3 plug.	106mm	59mm	30mm	84mm apart	34
408/3A	Clock Point Socket, three pins, alternative configuration, suits 409/3A plug.	106mm	59mm	30mm	84mm apart	34
408/4	Clock Point Socket, four pins, suits 409/4 plug.	106mm	59mm	30mm	84mm apart	34

ESCUTCHEON PLATE SOCKETS (AMERICAN STANDARD PATTERN)

405	Escutcheon Plate Socket, 250V, 10A a.c., two parallel flat pins.	94mm	42mm	23mm	84mm apart	34
405/32	Escutcheon Plate Socket, 32V, 15A a.c., two polarised flat pins.	94mm	42mm	23mm	84mm apart	34
415	Escutcheon Plate Socket, 250V, 10A, a.c., three pins.	94mm	42mm	27mm	84mm apart	34
415L	Escutcheon Plate Socket, 250V, 10A, a.c., three pins, round earth pin.	94mm	42mm	27mm	84mm apart	34
415/15	Escutcheon Plate Socket, 250V, 15A, a.c., three pins.	94mm	42mm	27mm	84mm apart	34
415/110	Escutcheon Plate Socket, 110V, 10A a.c., two round live pins & flat earth pin.	94mm	42mm	27mm	84mm apart	34

FLUSH SOCKET MOULDED ESCUTCHEON PLATES

321	Flush Socket Moulded Escutcheon Plate, suits 320 Series flush switch mechanism.	115mm	70mm	7mm	60mm	35
321R	Flush Socket Moulded Escutcheon Plate, suits single socket mechanism.	115mm	70mm	7mm	60mm	35
322/1R	Flush Socket Moulded Escutcheon Plate, suits one 320 Series switch and one flush socket.	115mm	115mm	7mm	60mm x 46mm	35

COOKER SOCKET OUTLET & PLUG

800CL	Plug/Lead with 3-pin plug, 1.8m, 4mm ² conductors, 250V/32A.	1.8m	N/A	N/A	N/A	35
31VCS	3 Pin Cooker Socket on standard plate, 250V/32A (suits 800CL).	115mm	73mm	11mm	84mm apart	35
2031VCS	3 Pin Cooker Socket on 2000 Series plate, 250V/32A (suits 800CL).	115mm	73mm	11mm	84mm apart	35

10 SERIES FLUSH MECHANISMS - AUTOMATICALLY SWITCHED

10M	Automatically Switched Flush Mechanism, 250V, 10A.	94mm	42mm	25mm	84mm apart	36
10MD	Automatically Switched Flush Mechanism, 250V, 10A, double pole.	94mm	42mm	25mm	84mm apart	36
10MDS	Automatically Switched Flush Mechanism, 250V, 10A, double pole, with safety shutters.	94mm	42mm	25mm	84mm apart	36
10MD15S	Automatically Switched Flush Mechanism, 250V, 15A, double pole, with safety shutters.	94mm	42mm	25mm	84mm apart	36
10MDL	Automatically Switched Flush Mechanism, 250V, 10A, double pole, round earth pin.	94mm	42mm	25mm	84mm apart	36
10MDLS	Automatically Switched Flush Mechanism, 250V, 10A, double pole, round earth pin, with safety shutters.	94mm	42mm	25mm	84mm apart	36
415MP	Unswitched Panel Mounted Socket, 250V, 10A.	45mm	42mm	25mm	N/A	36
415MP15	Unswitched Panel Mounted Socket, 250V, 15A.	45mm	42mm	25mm	N/A	36
415MPL	Unswitched Panel Mounted Socket, 250V, 10A, with round earth for lighting.	45mm	42mm	25mm	N/A	36

PLUGS, SOCKETS & ADAPTORS PRODUCT LISTING

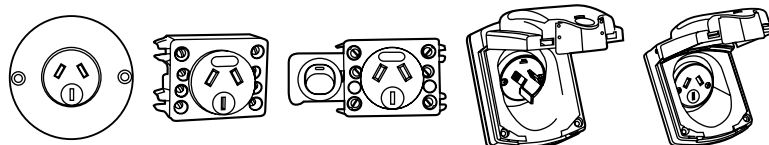

G10 SERIES MECHANISMS						
Cat No	Description	Length	Width	Depth	Mounting Ctrs	PAGE
G10MDS	Automatically Switched Mechanism, 250V, 10A, double pole, with safety shutters, suits GEC compact floor outlets.	46mm	46mm	26mm	N/A	37
G10F SERIES MECHANISMS						
G10FMDS	Automatically Switched Mechanism, 250V, 10A, double pole, with safety shutters, suits GEC AF Series floor outlets.	74mm \varnothing		26mm	64mm apart	37
G10FMDLS	Automatically Switched Mechanism, 250V, 10A, double pole, round earth, with safety shutters, suits GEC AF Series floor outlets.	74mm \varnothing		26mm	64mm apart	37
G10FMD15S	Automatically Switched Mechanism, 250V, 15A, double pole, with safety shutters, suits GEC AF Series floor outlets.	74mm \varnothing		26mm	64mm apart	37
REAR CONNECTING FLUSH SOCKETS						
426	Rear connecting Flush Socket, 250V, 10A, three pins.	66mm \varnothing		24mm	50mm apart	37
426L	Rear Connecting Flush Socket, 250V, 10A, three pins, round earth pin.	66mm \varnothing		24mm	50mm apart	37
426/15	Rear connecting Flush Socket, 250V, 15A, three pins.	66mm \varnothing		24mm	50mm apart	37
AUTOMATICALLY SWITCHED SKIRTING DUCT SOCKETS						
12M	Automatically Switched Skirting Duct Socket, 250V, 10A.	63mm	43mm	29mm	N/A	38
12M15	Automatically Switched Skirting Duct Socket, 250V, 15A.	63mm	43mm	29mm	N/A	38
12MD15	Automatically Switched Skirting Duct Socket, 250V, 15A, double pole.	63mm	43mm	29mm	N/A	38
MANUALLY SWITCHED SKIRTING DUCT SOCKETS						
17M	Manually Switched Skirting Duct Socket, 250V, 10A.	90mm	43mm	29mm	N/A	39
17M15	Manually Switched Skirting Duct Socket, 250V, 15A.	90mm	43mm	29mm	N/A	39
INLET SOCKETS						
435	Inlet Socket, 250V, 10A.	85mm \varnothing		36mm	70mm apart	39
435L	Inlet Socket, 250V, 10A, round earth.	85mm \varnothing		36mm	70mm apart	39
435A	Inlet Socket, 250V, 10A, with terminal cover.	85mm \varnothing		41mm	70mm apart	39
435A15	Inlet Socket, 250V, 15A, with terminal cover.	85mm \varnothing		41mm	70mm apart	39
435/110	Inlet Socket, 110V, 10A, two round live pins and a flat earth.	85mm \varnothing		36mm	70mm apart	39
WEATHERPROOF INLET SOCKET & SPACER BLOCK						
435VF15*	Weatherproof Inlet Socket, 250V, 15A, IP43 rating.	89mm	76mm	41mm	70mm x 54mm	40
435VFS15	Weatherproof Inlet Socket, 250V, 15A, insulated active and neutral pins, IP34 rating, terminal bores accommodate 3 x 2.5mm ² cords.	101mm	80mm	37mm	76mm x 65mm	40
435VFS15FLAP	Replacement Flap for 435VFS15.	108mm	80mm	28mm	N/A	40
435VFM	Spacer block for mounting 435VF15 and 10DWP.	89mm	76mm	13mm	70mm x 54mm	40
435VFSM	Mounting Flange for 415VF & 435VF15 Series (available in White Electric only).	101mm	80mm	12mm	76mm x 65mm	40
WEATHERPROOF FLUSH OUTLET						
10DWP†	Weatherproof Flush Outlet, 250V, 10A, double pole, IP53 rating.	93mm	82mm	26mm	70mm x 54mm	41
10DWP15†	Weatherproof Flush Outlet, 250V, 15A, double pole, IP44 rating, terminal bores accommodate 4 x 2.5mm ² cords.	93mm	82mm	26mm	70mm x 54mm	41
415VF	Weatherproof Caravan Outlet, 250V, 10A, IP34 rating.	101mm	80mm	38mm	76mm x 65mm	41
415VF15	Weatherproof Caravan Outlet, 250V, 15A, IP34 rating.	101mm	80mm	38mm	76mm x 65mm	41
415VFFLAP	Replacement Flap for 415VF Series.	108mm	80mm	38mm	N/A	41
435VFSM	Mounting Flange for 415VF Series & 435VFS15 Series.	101mm	80mm	12mm	76mm x 65mm	41

* To be superseded by 435VFS Series.

† To be superseded by 415VF Series.



Our plug for safety

Don't be left out in the dark.

Clipsal's new and improved Caravan Inlet & Outlet range - helping to supply caravan and mobile home holiday makers with power.

Caravan and mobile home holidays are now becoming increasingly popular, with Australians now having access to almost 3,000 caravan parks and camp grounds to choose from around the country.

Safety First

The 435VFS15 model now has insulated safety pins to prevent accidental electrical contact.

The 435VFS15 now has a recess placed in the inlet to allow the acceptance of a 15A shrouded female socket (Cat No. 438S15).

Stay Open Flap

Both the 435VFS15 and 415VF series have an improved cover flap that will now remain open whilst the user is plugging in plugs and sockets.

Handy New Features

The new improved flap has been designed with a rubber curtain attached to it which prevents water ingress and also secures the flexible cable and plug in its place to prevent it from falling out.



435VFS15

415VF

For more information, see Pages 40 to 41 or ask for a copy of the brochure

clipsal.com



1. Remove outer sheathing only to required length.



2. Lay cable into terminal paths.



3. Close lid and squeeze with pliers till both "clips" latch.

Also available in the QC Range:

413QC Bulk packs of 100 - Cat No. 413QCB100,WE **Quick Connect Pliers** - Cat No. 852QCP & 852QCPH (Quick Connect Pliers are 1000V rated)

GPOs - (2000 Series) - Cat No. 2025QC, **(C2000 Series)** - Cat No. C2025QC, **(C2000 bulk pack of 100)** - Cat No. C2025QCBULK,WE



Install a surface socket at world record speed

You can now install a surface socket faster than you ever have before.

In fact 50% faster. Clipsal's Quick Connect 413QC Surface Socket requires no stripping or twisting of cables, no screwing down of conductors and you don't even need to use a nail plate. Simply remove the outer sheathing to the required length, lay the insulated cables into the terminal paths, close the lid squeeze shut with your pliers and you're done!

Put some thrust into your surface socket installations and make the change to Clipsal Quick Connect 413QC.

**For more information,
see Page 30 or ask
for a copy of the
Quick Connect
brochure.**



**QUICK
CONNECT**

Product of Clipsal Australia Pty Ltd

ABN 27 007 873 529

Head Office

12 Park Terrace, Bowden
South Australia 5007
Telephone (08) 8269 0511
Facsimile (08) 8340 1724
Internet clipsal.com
E-Mail plugin@clipsal.com.au

Offices in all States

NSW	Sydney	(02) 9794 9200
	Albury	(02) 6041 2377
VIC	Melbourne	(03) 9207 3200
	Country Areas	1800 653 893
QLD	Brisbane	(07) 3244 7444
	Townsville	(07) 4729 3333
SA	Adelaide	(08) 8268 0400
WA	Perth	(08) 9442 4444
TAS	Launceston	(03) 6343 5900
NT	Darwin	(08) 8947 0278

Area Representatives

NSW	Albury	(02) 6041 2377
	Mid North Coast	0418 430 361
	Coffs Harbour	0418 653 183
	Dubbo	0418 822 564
	Newcastle	0407 298 792
		0418 434 169
		0418 686 040
	South West Sydney	0419 868 353
	Tamworth	0417 714 339
	Wagga Wagga	0418 578 903
Wollongong	0418 423 581	
ACT	Canberra	0419 238 824
		0418 164 070
VIC	Bendigo	0418 570 213
	Geelong	0418 527 233
	Gippsland	0418 512 680
	Western Victoria	0419 380 444
QLD	Cairns	0418 773 254
	Mackay	0418 752 134
	Maryborough	0418 664 338
	Northern Rivers	0418 768 902
	Rockhampton	0419 869 752
	Sunshine Coast	0418 711 786
	Toowoomba	0418 726 394
Townsville	0418 180 372	
WA	Bunbury	0418 931 684
	Kalgoorlie & Eastern Gold Fields	0417 928 981
	Karratha	0418 937 249
SA	Riverland/Mildura/ Broken Hill	0418 596 145

International Enquiries

International Sales and Marketing

Telephone + 61 8 8269 0587
Facsimile + 61 8 8340 7350
E-Mail export@clipsal.com.au

New Zealand

Clipsal Industries (NZ) Ltd

Telephone (09) 576 3403
Facsimile (09) 576 1015
E-Mail headoffice@clipsal.co.nz

Customer Service

Free Fax (0508) 250 305
Auckland/Mobile Phone (09) 572 0014
Free Phone (0508) CLIPSAL
2547725

You can find this brochure and many others online in PDF format at:
clipsal.com

Follow the links off the home page or access the following page directly:
clipsal.com/wat_lib_pdf.cfm

clipsal.com



The shape of the switch dolly is a trade mark of Clipsal Australia Pty Ltd

Clipsal Australia Pty Ltd reserves the right to change specifications, modify designs and discontinue items without incurring obligation and whilst every effort is made to ensure that descriptions, specifications and other information in this catalogue are correct, no warranty is given in respect thereof and the company shall not be liable for any error therein.

©Copyright Clipsal Australia Pty Ltd 2005.
All rights reserved.

This material is copyright under Australian and international laws. Except as permitted under the relevant law, no part of this work may be reproduced by any process without prior written permission of and acknowledgement to Clipsal Australia Pty Ltd.

X-ON Electronics

Largest Supplier of Electrical and Electronic Components

Click to view similar products for [Lutze manufacturer](#):

Other Similar products are found below :

[492076](#) [750340](#) [750540](#) [750809.0000](#) [750819.0000](#) [716425](#) [750517](#) [716400](#) [716428](#) [490113.0030](#) [750539](#) [716438](#) [716401](#) [716409](#)