



Q60AFV Series Sensors with Visible Red Emitter

Self-Contained Adjustable-Field Sensors

Q60AFV Adjustable-Field Features



- Adjustable-field background suppression sensor detects objects within a defined sensing field, while ignoring objects located beyond the sensing field cutoff
- Two-turn, logarithmic adjustment of sensing field cutoff point from 0.2 to 1 m; allows easy setting of cutoff point at long range
- Rotating pointer indicates relative cutoff point setting
- Easy push-button or remote programming of light/dark operate and output timing; continuous status indicators verify all settings at a glance
- Output ON and/or OFF delays adjustable from 8 milliseconds to 16 seconds
- Powerful, highly collimated visible red sensing beam
- Tough ABS/polycarbonate blend housing is rated IEC IP67; NEMA 6

10-30V dc Models (Q60BB6AFV):

- Powered by 10 to 30V dc; bipolar (one NPN and one PNP) outputs
- Available with integral cable or rotating Euro-style quick-disconnect fitting

Universal Voltage Models (Q60VR3AFV):

- 12-250V dc or 24-250V ac, 50/60 Hz
- Available with integral cable or rotating Micro-style quick-disconnect fitting

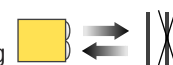

Visible Red, 665 nm

Q60 Adjustable-Field Models

Models	Minimum Range	Cutoff Point	Cable*	Supply Voltage	Output Type	Excess Gain at 200 mm Cutoff	Excess Gain at 1000 mm Cutoff
Q60BB6AFV1000	65 mm to 130 mm (2.5" to 5") depending on cutoff point setting	Adjustable: 200 mm to 1000 mm (8" to 40")	5-wire 2 m (6.5')	10-30V dc	Bipolar NPN/PNP		
Q60BB6AFV1000Q			5-pin Euro-style QD				
Q60VR3AFV1000			5-wire 2 m (6.5')	Universal Voltage 12-250V dc or 24-250V ac	E/M Relay (SPDT), normally closed and normally open contacts		
Q60VR3AFV1000Q1			4-pin Micro-style QD		E/M Relay (SPST), normally open contact		

* 9 meter cables are available by adding suffix "W/30" to the model number of any cabled sensor (e.g., Q60BB6AFV1000 W/30). A model with a QD connector requires a mating cable; see page 8.



WARNING . . . Not To Be Used for Personnel Protection

Never use these products as sensing devices for personnel protection. Doing so could lead to serious injury or death.

These sensors do NOT include the self-checking redundant circuitry necessary to allow their use in personnel safety applications. A sensor failure or malfunction can cause either an energized or de-energized sensor output condition. Consult your current Banner Safety Products catalog for safety products which meet OSHA, ANSI and IEC standards for personnel protection.

Q60V Series Adjustable-Field Sensors – Visible Red Emitter

Q60AFV Overview

The Q60AFV sensor is a full-featured adjustable-field sensor. These adjustable-field sensors are able to detect objects of relatively low reflectivity, while ignoring other objects in the background (beyond the cutoff point). The cutoff distance is mechanically adjustable, using the 2-turn adjustment screw on the sensor top (Figure 1). A rotating pointer indicates the relative cutoff position. (The indicator moves clockwise to show increasing distance.)

Two push buttons (ON Delay and OFF Delay) are used to set the output delay options, to toggle between light and dark operate modes and to lock out the push buttons for security purposes. These functions also may be accomplished using the remote wire.

Seven LED indicators show, during RUN mode, the sensor configuration and operating status. During Delay Configuration, 5 of the LEDs combine to form a single light bar that indicates relative ON or OFF delay time.

Adjustable-Field Sensing — Theory of Operation

In operation, the Q60AFV compares the reflections of its emitted light beam (E) from an object back to the sensor's two differently-aimed detectors R1 and R2 (see Figure 2). If the near detector (R1) light signal is stronger than the far detector (R2) light signal (see object A, closer than the cutoff distance), the sensor responds to the object. If the far detector (R2) light signal is stronger than the near detector (R1) light signal (see object B, object beyond the cutoff distance), the sensor ignores the object.

The cutoff distance for Q60AFV sensors is adjustable from 200 to 1000 millimeters (8" to 40"). Objects lying beyond the cutoff distance are ignored, even if they are highly reflective. However, it is possible to falsely detect a background object, under certain conditions (see Background Reflectivity and Placement, page 3).

In the drawings and discussion on this page and page 3, the letters E, R1, and R2 identify how the sensor's three optical elements (Emitter "E", Near Detector "R1", and Far Detector "R2") line up across the face of the sensor. The location of these elements defines the sensing axis (see Figure 3). The sensing axis becomes important in certain situations, such as those illustrated in Figures 8 and 9.

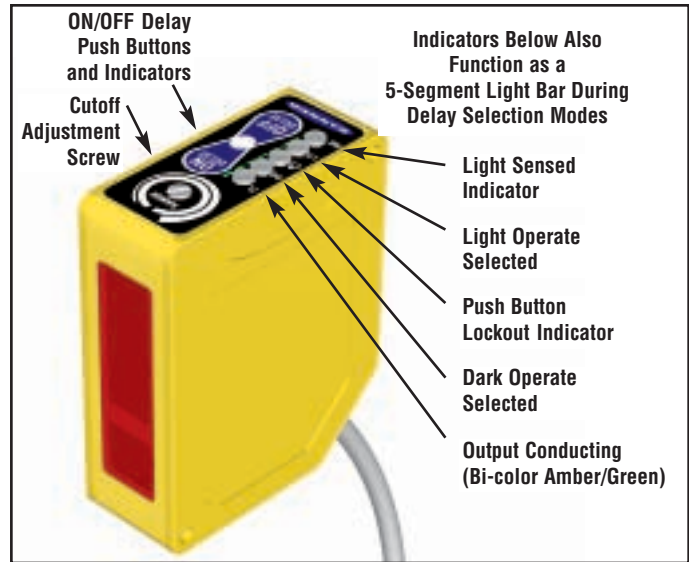

Figure 1. Q60V features

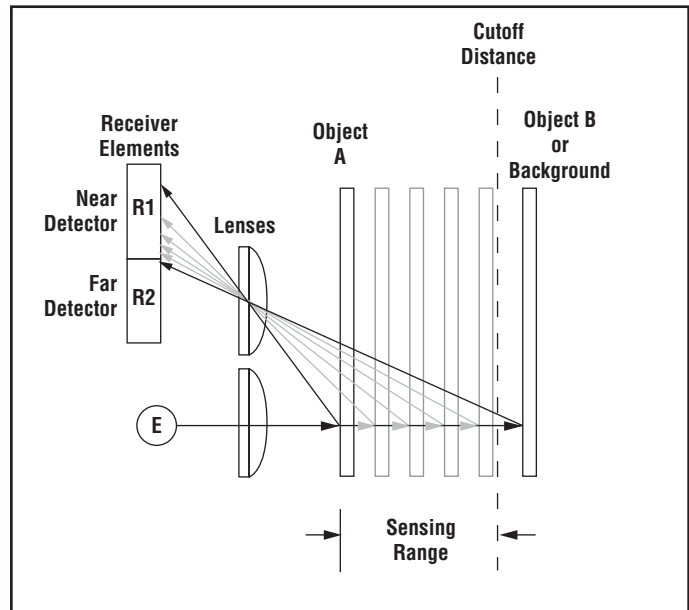

Figure 2. Adjustable field sensing concept

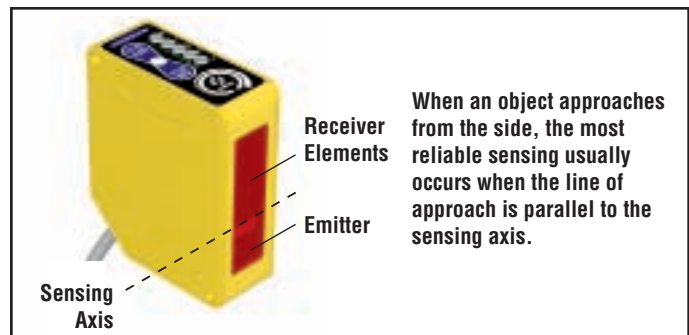

Figure 3. Q60V sensing axis

Q60V Series Adjustable-Field Sensors – Visible Red Emitter

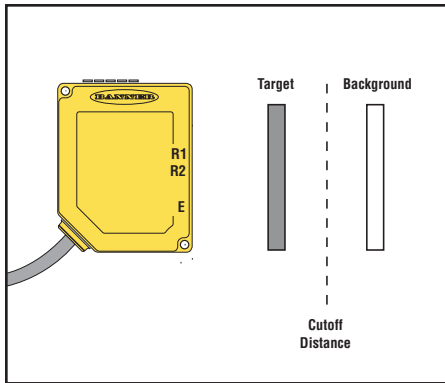

Figure 4. Set cutoff distance approximately midway between the farthest target and the closest background

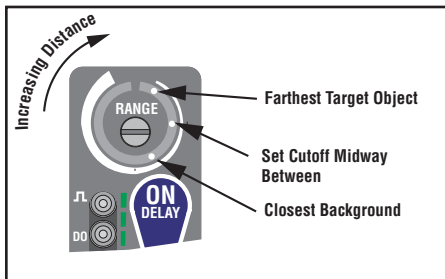

Figure 5. Setting the cutoff distance

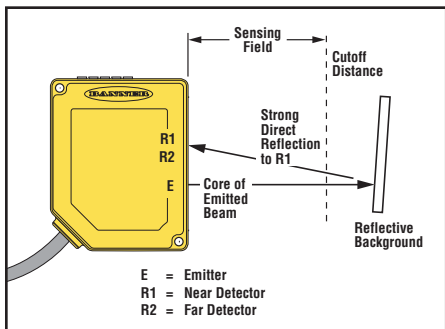

Figure 6. Reflective background – problem

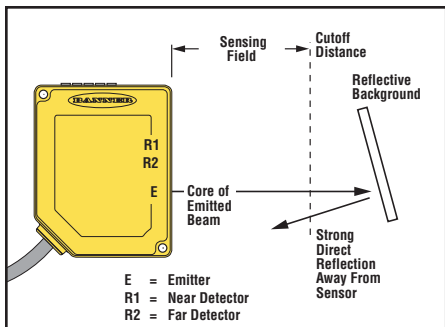

Figure 7. Reflective background – solution

Sensor Setup

Setting the Cutoff Distance

The cutoff distance for Q60AFV sensors may be adjusted between 200 mm and 1000 mm (8" to 40").

To maximize contrast, position the lightest possible background to be used, at the closest position it will come to the sensor during use (Figure 4). Using a small screwdriver in the adjustment screw, adjust the cutoff distance until the threshold is reached and the green Light Sensed indicator changes state. (If the indicator never comes ON, the background is beyond the maximum sensing cutoff and will be ignored.) Note the position of the rotating cutoff position indicator at this position. Then repeat the procedure, using the darkest target, placed in its most distant position for sensing. Adjust the cutoff so that the indicator is midway between the two positions (Figure 5).

NOTE: Setting the cutoff distance adjustment screw to its maximum clockwise position places the receiver lens directly in front of the receiver elements and results in the Q60 performing as a long-range diffuse sensor.

Sensing Reliability

For highest sensitivity, the sensor-to-object distance should be such that the object will be sensed at or near the point of maximum excess gain. The excess gain curves on page 1 show excess gain vs. sensing distance for 200 mm and 1 m cutoffs. Maximum excess gain for a 200 mm cutoff occurs at a lens-to-object distance of about 150 mm, and for a 1 m cutoff, at about 400 mm. The background must be placed beyond the cutoff distance. Following these two guidelines makes it possible to detect objects of low reflectivity, even against close-in reflective backgrounds.

Background Reflectivity and Placement

Avoid mirror-like backgrounds that produce specular reflections. False sensor response will occur if a background surface reflects the sensor's light more strongly to the near detector (R1) than to the far detector (R2). The result is a false ON condition (Figure 6). Use of a diffusely-reflective (matte) background will cure this problem. Other possible solutions are to angle either the sensor or the background (in any plane) so that the background does not reflect back to the sensor (see Figure 7).

An object beyond the cutoff distance, either moving or stationary (and when positioned as shown in Figure 8), can cause unwanted triggering of the sensor because it reflects more light to the near detector than to the far detector. The problem is easily remedied by rotating the sensor 90° (Figure 9) to align the sensing axis horizontally. The object then reflects the R1 and R2 fields equally, resulting in no false triggering.

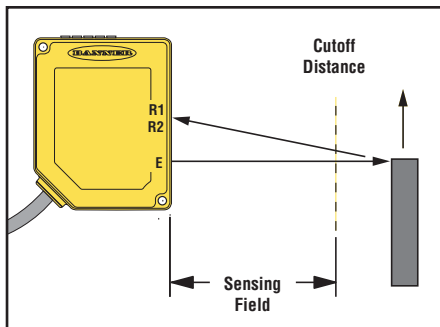

Figure 8. Object beyond cutoff distance – problem

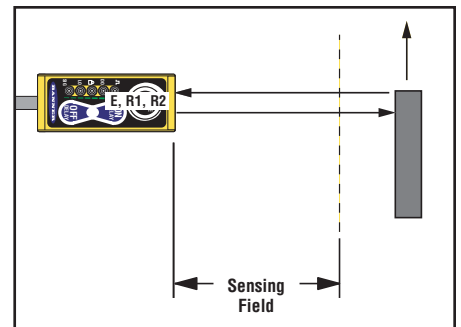

Figure 9. Object beyond cutoff distance – solution

Q60V Series Adjustable-Field Sensors – Visible Red Emitter

Color Sensitivity

The effects of object reflectivity on cutoff distance, though small, may be important for some applications.

The excess gain curves on page 1 were generated using a white test card of 90% reflectance. Objects with reflectivity of less than 90% reflect less light back to the sensor, and thus require proportionately more excess gain in order to be sensed with the same reliability as more reflective objects. When sensing an object of very low reflectivity, it may be especially important to sense it at or near the distance of maximum excess gain.

It is expected that at any given cutoff setting, the actual cutoff distance for lower reflectance targets will be slightly shorter than for higher reflectance targets (see Figure 10). This behavior is known as color sensitivity.

The percentage of deviation indicates a change in the cutoff point for either 18% gray or 6% black targets, relative to the cutoff point set for a 90% reflective white test card.

For example, the cutoff point decreases 4% for a 6% reflectance black target when the cutoff point is adjusted for 1000 mm (40") using a 90% reflectance white test card. In other words, the cutoff point for the black target is 960 mm (38") for this setting.

Setting the Output Delay

The output of the Q60AFV sensor may be delayed between 0.008 and 16 seconds, in any of 72 increments. Delay is indicated on the 5-segment light bar using single LED segments or combinations of them, in varying stages of intensity. Major increments, displayed by a single full-intensity LED, are shown in Figure 13.

Step #	Delay Time	LED Status
0	No Delay	
8	0.062 second	
24	0.250 second	
40	1.00 second	
56	4.0 seconds	
72	16 seconds	

Figure 13. ON/OFF Delay options

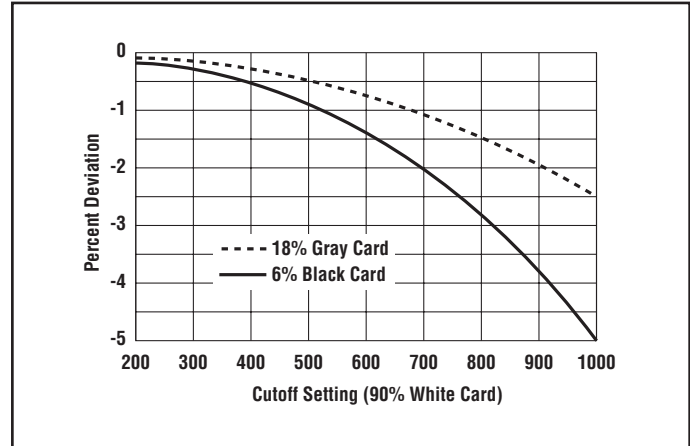

Figure 10. Q60V Cutoff point deviation

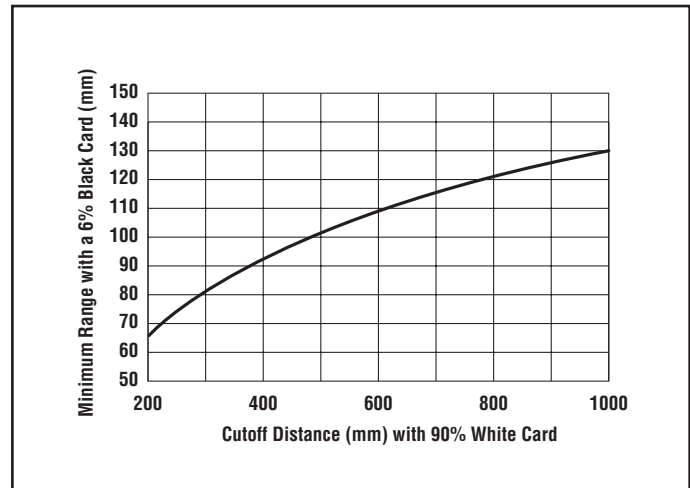

Figure 11. Q60V minimum range vs. cutoff setting

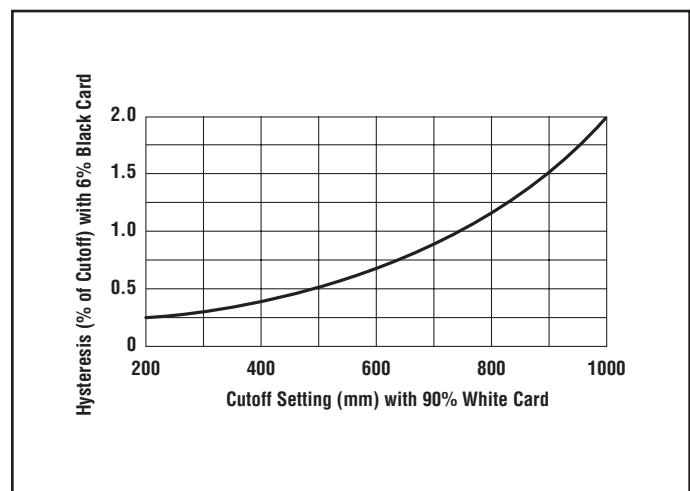

Figure 12. Q60V hysteresis

Q60V Series Adjustable-Field Sensors – Visible Red Emitter

To set a delay, single-click the appropriate button or pulse the remote wire as shown in Figure 14 to enable the process. Then use the + or – button or the appropriate remote wire pulse procedure to increase or decrease the delay (single-click adjusts the delay by one step at a time, and holding the button in provides a rapid increase/decrease).

NOTE: Remote wire available on models Q60BB6AFV(Q1) only.

T = 40 – 800 ms

Press and Hold > 800 ms unless otherwise noted











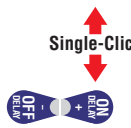
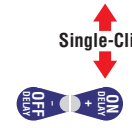

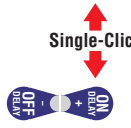

Increase ON Delay – 4-second time-out				
Push Button	 Enter ON Delay Setup	 Step Increment	 Rapid Increment	
Remote	 Enter ON Delay Setup	 Enable Delay Increment	 Step Increment	 Rapid Increment
Decrease ON Delay – 4-second time-out				
Push Button	 Enter ON Delay Setup	 Step Decrement	 Rapid Decrement	
Remote	 Enter ON Delay Setup	 Enable Delay Decrement	 Step Decrement	 Rapid Decrement
Increase OFF Delay – 4-second time-out				
Push Button	 Enter OFF Delay Setup	 Step Increment	 Rapid Increment	
Remote	 Enter OFF Delay Setup	 Enable Delay Increment	 Step Increment	 Rapid Increment
Decrease OFF Delay – 4-second time-out				
Push Button	 Enter OFF Delay Setup	 Step Decrement	 Rapid Decrement	
Remote	 Enter OFF Delay Setup	 Enable Delay Decrement	 Step Decrement	 Rapid Decrement

Figure 14. ON/OFF Delay configuration procedure

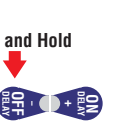
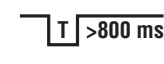
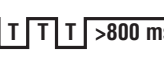
Q60V Series Adjustable-Field Sensors – Visible Red Emitter

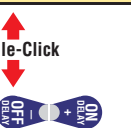
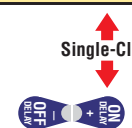
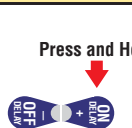
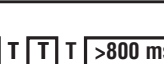
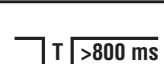
Light/Dark Operate Select

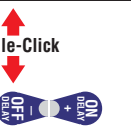
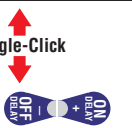
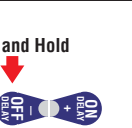
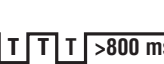
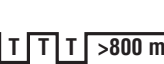
Light Operate or Dark Operate mode may be selected using the two push buttons or a 4-second pulse of the remote line to toggle between the selections. See Figure 15.

Push Button Lockout

For security, the push buttons may be locked out using either the remote line or the push buttons themselves. See Figure 16.

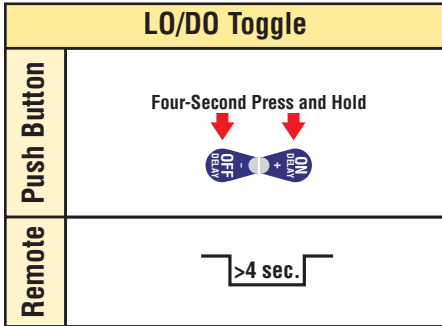

Figure 15. Light/Dark operate toggle options

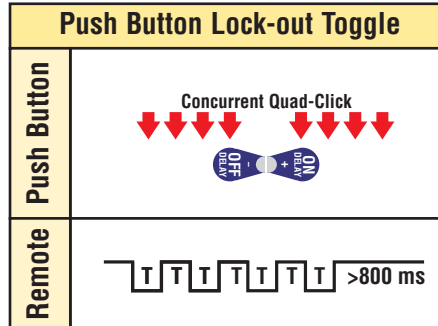
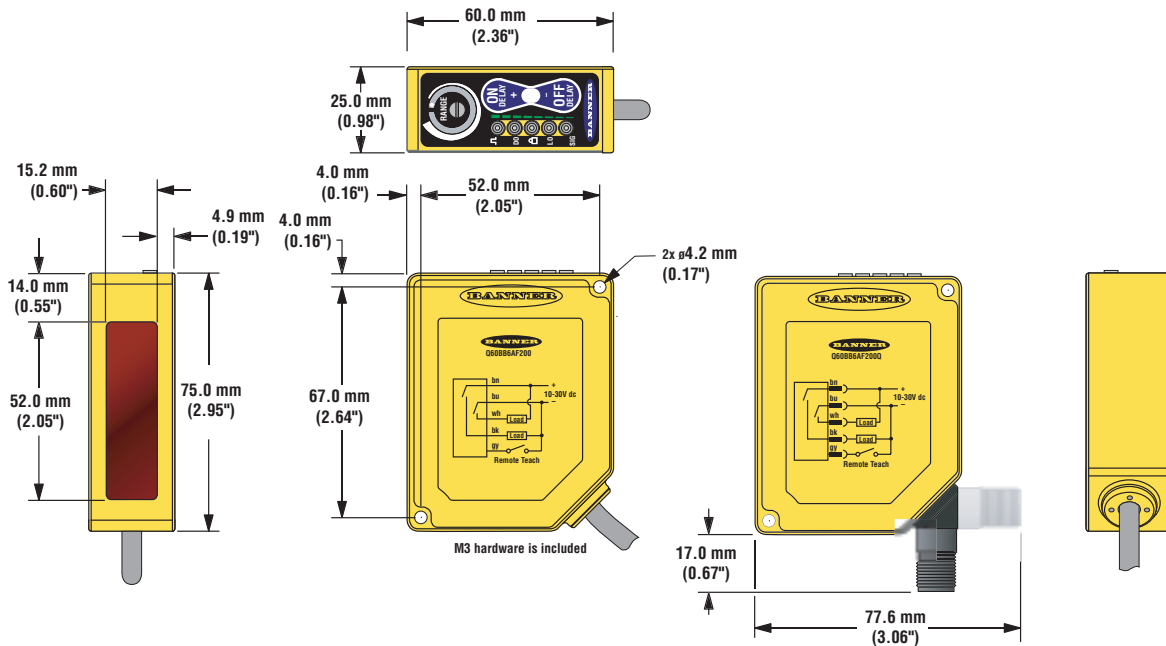

Figure 16. Lockout toggle

Q60V Adjustable-Field Sensor Dimensions



Q60V Specifications

Supply Voltage and Current	Q60BB6AFV models: 10 to 30V dc (10% maximum ripple) at less than 50 mA exclusive of load Q60VR3AFV Universal models: 12 to 250V dc or 24 to 250V ac, 50/60 Hz
Supply Protection Circuitry	Protected against reverse polarity and transient voltages (Q60VR3 models' dc hookup is without regard to polarity)
Output Configuration	Q60BB6AFV models: Bipolar; one NPN (current sinking) and one PNP (current sourcing) open-collector transistor Q60VR3AFV cabled model: E/M Relay (SPDT), normally closed and normally open contacts Q60VR3AFVQ1 (QD) model: E/M Relay (SPST), normally open contact

Q60V Series Adjustable-Field Sensors – Visible Red Emitter

Q60V Specifications

Output Rating	<p>Q60BB6AFV models 150 mA maximum each output @ 25° C Off-state leakage current: < 5µA @ 30V dc Output saturation NPN: < 200 mV @ 10 mA and < 1V @150mA Output saturation PNP: < 1V at 10 mA; < 1.5V at 150 mA</p> <p>Q60VR3AFV Universal models Min. voltage and current: 5V dc, 10 mA Mechanical life of relay: 50,000,000 operations Electrical life of relay at full resistive load: 100,000 operations Max. switching power (resistive load): Cabled models: 1250VA, 150 W QD models: 750VA, 90W Max. switching voltage (resistive load): Cabled models: 250V ac, 125V dc QD models: 250V ac, 125V dc Max. switching current (resistive load): Cabled models: 5 A @ 250V ac, 5 A @ 30V dc derated to 200 mA @ 125V dc QD models: 3 A @ 250V ac, 3 A @ 30V dc derated to 200 mA @ 125V dc</p>
Output Protection Circuitry	<p>Q60BB6AFV models: Protected against continuous overload or short circuit of outputs All models: Protected against false pulse on power-up</p>
Output Response Time	<p>Q60BB6AFV models: 2 milliseconds ON and OFF NOTE: 150 millisecond delay on power-up; outputs do not conduct during this time. Q60VR3AFV Universal models: 15 milliseconds ON and OFF NOTE: 150 millisecond delay on power-up; relay is de-energized during this time.</p>
Repeatability	500 microseconds
Sensing Hysteresis	See Figure 12.
Indicators NOTE: Outputs are active during on/off timing selection mode.	<p>ON Delay Steady Green: Run mode, ON delay is active Flashing Green: ON Delay Selection mode is active</p> <p>OFF Delay Steady Green: Run mode, OFF delay is active Flashing Green: OFF Delay Selection mode is active</p> <p>5-Segment Light Bar*: Indicates relative delay time during ON or OFF Delay Selection modes</p> <p>Output Steady Amber: Outputs are conducting Steady Green: During ON/OFF Delay Selection modes</p> <p>Dark Operate Steady Green: Dark Operate is selected</p> <p>Lockout Steady Green: Buttons are locked out</p> <p>Light Operate Steady Green: Light Operate is selected</p> <p>Signal Steady Green: Sensor is receiving signal Flashing Green: Marginal signal (1.0 to 2.25 excess gain)</p> <p>*Output, Dark Operate, Lockout, Light Operate and Signal indicators function as 5-Segment Light Bar during ON or OFF Delay Selection modes</p>
Adjustments	<p>2 momentary push buttons: ON Delay (+) and OFF Delay (-) (DC models also have remote program wire) ON Delay select: 8 ms to 16 seconds OFF Delay select: 8 ms to 16 seconds LO/DO select Push button lockout for security</p> <p>Slotted, geared, 2-turn, cutoff range adjustment screw (mechanical stops on both ends of travel)</p>
Construction	Housing: ABS polycarbonate blend Lens: Acrylic Cover: Clear ABS
Environmental Rating	IEC IP67; NEMA 6
Connections	2 m (6.5') or 9 m (30') attached cable, 5-pin Euro-style fitting, or 5-pin Mini-style 150 mm (6") QD pigtail, depending on model. QD cables are ordered separately; see page 8.
Operating Conditions	<p>Temperature: -20° to +55°C (-7° to +131°F) Maximum Relative Humidity: 90% at 50°C (non-condensing)</p>
Certifications	

Q60V Series Adjustable-Field Sensors – Visible Red Emitter

Q60V Adjustable-Field Hookups

Q60BB6AFV1000(Q)
(Cabled and QD Models)
10 to 30V dc

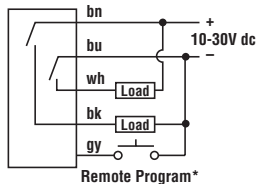

5-Pin Euro-Style Pin-out
(Cable Connector Shown)

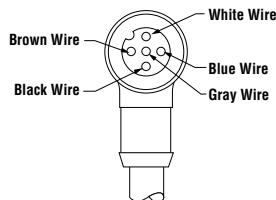

Q60VR3AFV1000
(Cabled Model)
24 to 250V ac (50/60Hz)
or 12 to 250V dc

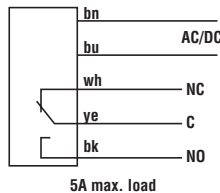

Q60VR3AFV1000Q1
(QD Model)
24 to 250V ac (50/60Hz)
or 12 to 250V dc

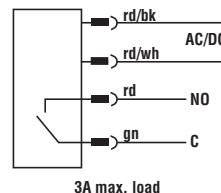

4-Pin Micro-Style Pin-out
(Cable Connector Shown)

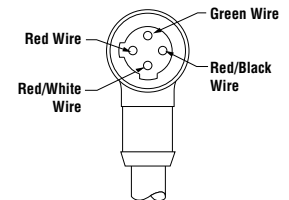

*DC models only; LO/DO and output delay select

Quick-Disconnect (QD) Cables

Style	Model	Length	Connector	Style	Model	Length	Connector
5-Pin Euro	MQDC1-506	2 m (6.5')	Straight	4-Pin Micro	MQAC-406	2 m (6.5')	Straight
	MQDC1-515	5 m (15')	Straight		MQAC-415	5 m (15')	Straight
	MQDC1-530	9 m (30')	Straight		MQAC-430	9 m (30')	Straight
	MQDC1-506RA	2 m (6.5')	Right-angle		MQAC-406RA	2 m (6.5')	Right-angle
	MQDC1-515RA	5 m (15')	Right-angle		MQAC-415RA	5 m (15')	Right-angle
	MQDC1-530RA	9 m (30')	Right-angle		MQAC-430RA	9 m (30')	Right-angle

SMBQ60

- Right-angle bracket
- 14-ga., 304 Stainless Steel

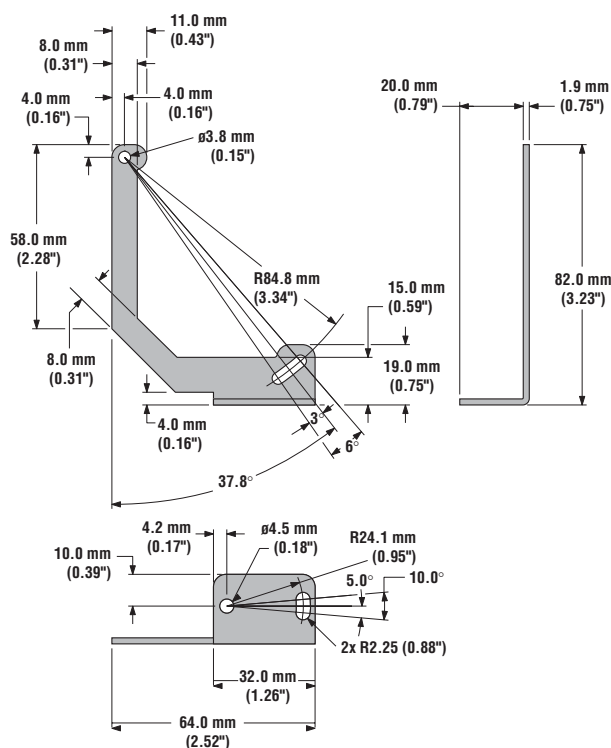

Banner Engineering Corp Limited Warranty

Banner Engineering Corp. warrants its products to be free from defects in material and workmanship for one year following the date of shipment. Banner Engineering Corp. will repair or replace, free of charge, any product of its manufacture which, at the time it is returned to the factory, is found to have been defective during the warranty period. This warranty does not cover damage or liability for misuse, abuse, or the improper application or installation of the Banner product.

THIS LIMITED WARRANTY IS EXCLUSIVE AND IN LIEU OF ALL OTHER WARRANTIES WHETHER EXPRESS OR IMPLIED (INCLUDING, WITHOUT LIMITATION, ANY WARRANTY OF MERCHANTABILITY OR FITNESS FOR A PARTICULAR PURPOSE), AND WHETHER ARISING UNDER COURSE OF PERFORMANCE, COURSE OF DEALING OR TRADE USAGE.

This Warranty is exclusive and limited to repair or, at the discretion of Banner Engineering Corp., replacement. **IN NO EVENT SHALL BANNER ENGINEERING CORP. BE LIABLE TO BUYER OR ANY OTHER PERSON OR ENTITY FOR ANY EXTRA COSTS, EXPENSES, LOSSES, LOSS OF PROFITS, OR ANY INCIDENTAL, CONSEQUENTIAL OR SPECIAL DAMAGES RESULTING FROM ANY PRODUCT DEFECT OR FROM THE USE OR INABILITY TO USE THE PRODUCT, WHETHER ARISING IN CONTRACT OR WARRANTY, STATUTE, TORT, STRICT LIABILITY, NEGLIGENCE, OR OTHERWISE.**

Banner Engineering Corp. reserves the right to change, modify or improve the design of the product without assuming any obligations or liabilities relating to any product previously manufactured by Banner Engineering Corp.



the photoelectric specialist

X-ON Electronics

Largest Supplier of Electrical and Electronic Components

Click to view similar products for [Banner manufacturer](#):

Other Similar products are found below :

[Q45VR2FPQ](#) [BTA23S](#) [L16F](#) [2LM3](#) [2PBA](#) [LM8-1](#) [LMT](#) [SM312CV](#) [SM31RQD](#) [LS4ELQ](#) [FX1](#) [Q45BB6LLQ](#) [D12SP6FP](#) [MBCC-412](#)
[BA23S](#) [BT21S](#) [BTA13S](#) [LM4-2](#) [T183E](#) [TL50GYR](#) [SM312DQDP-68020](#) [SLSP30-600Q88](#) [SLSP30-1200Q88](#) [OTC-1-YW](#) [OPBA5](#) [PBAT](#)
[SBLV1](#) [SMA91EQD](#) [SMA91E](#) [SMA912LVQD](#) [SMA912DQD](#) [SM2A312CVQD](#) [SM2A912LVQD](#) [SM312F](#) [SM31RL](#) [Q60BB6AFV1000Q](#)
[TL70GYRAQ](#) [TL70RQ](#) [SM312FMHSQD](#) [SM312W](#) [MMD-TA-11B](#) [LED70X70-78587](#) [T18-2VNDL-Q8](#) [T18-2VPFF200-Q8](#) [T18-](#)
[2VPLP-Q8](#) [SLC4P14-160P44](#) [SLC4P24-160P44](#) [SLLP14-1190P88](#) [SM312CUQD](#) [BR-2](#)