

Features :

- High performance thermal insulation materials
- Good thermal fatigue performance
- International standard package

Typical Applications

- Various rectifiers
- DC supply for PWM inverter

V_{RSM}	V_{RRM}	Type & Outline
900V	800V	MDx100-08
1100V	1000V	MDx100-10
1300V	1200V	MDx100-12
1500V	1400V	MDx100-14
1700V	1600V	MDx100-16
1900V	1800V	MDx100-18

SYMBOL	CHARACTERISTIC	TEST CONDITIONS	$T_j(^{\circ}C)$	VALUE			UNIT
				Min	Type	Max	
$I_{F(AV)}$	Mean forward current	180° half sine wave 50Hz Single side cooled, $T_C=100^{\circ}C$	150			100	A
$I_{F(RMS)}$	RMS forward current		150			157	A
I_{RRM}	Repetitive peak current	at V_{RRM}	150			10	mA
I_{FSM}	Surge forward current	10ms half sine wave	150			2.60	KA
I^2t	I^2T for fusing coordination	$V_R=0.6V_{RRM}$				34	A^2s*10^3
V_{FO}	Threshold voltage		150			0.80	V
r_F	Forward slop resistance					1.74	mΩ
V_{FM}	Peak forward voltage	$I_{FM}=300A$	25			1.45	V
$R_{th(j-c)}$	Thermal resistance Junction to case	At 180° sine: Single side cooled per chip				0.350	$^{\circ}C/W$
$R_{th(c-h)}$	Thermal resistance case to heatsink	At 180° sine: Single side cooled per chip				0.2	$^{\circ}C/W$
V_{iso}	Isolation voltage	50Hz, R.M.S, t=1min, $I_{iso}:1mA(max)$		2500			V
F_m	Terminal connection torque(M5)				4		N·m
	Mounting torque(M6)				6		N·m
T_{stg}	Stored temperature			-40		125	$^{\circ}C$
W_t	Weight				105		g
Outline	M01H						

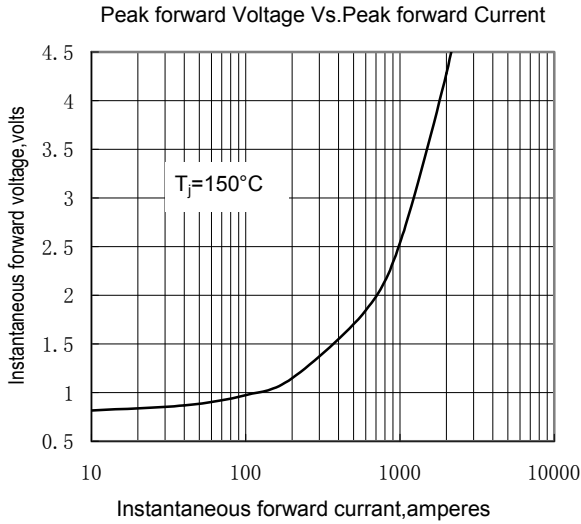
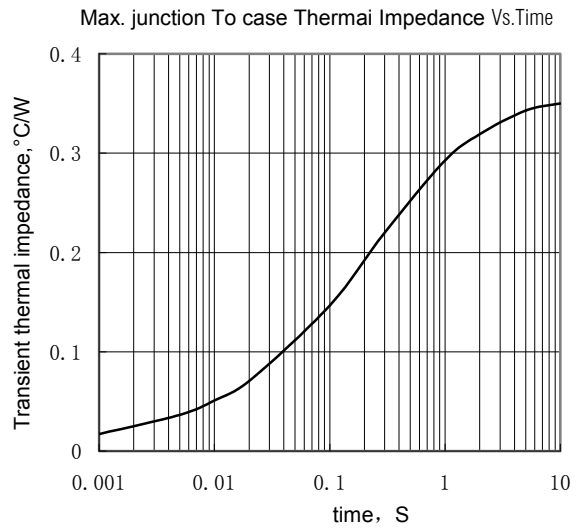
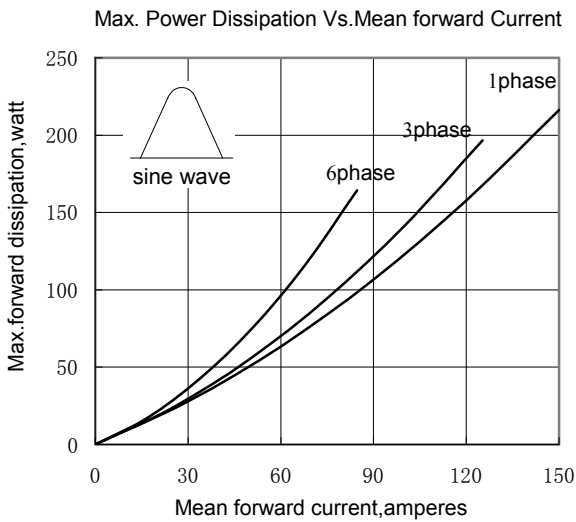
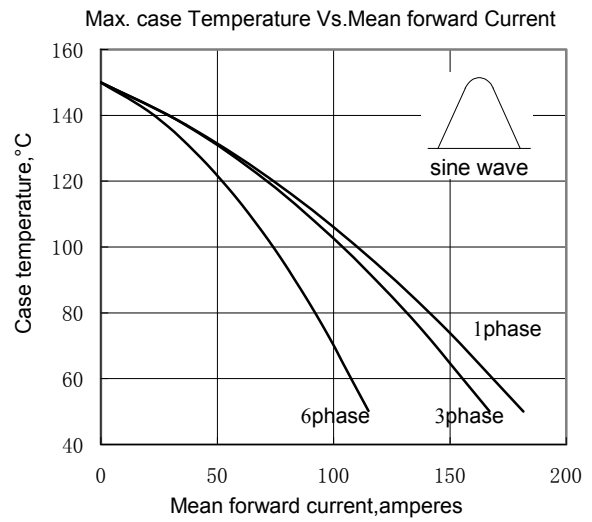
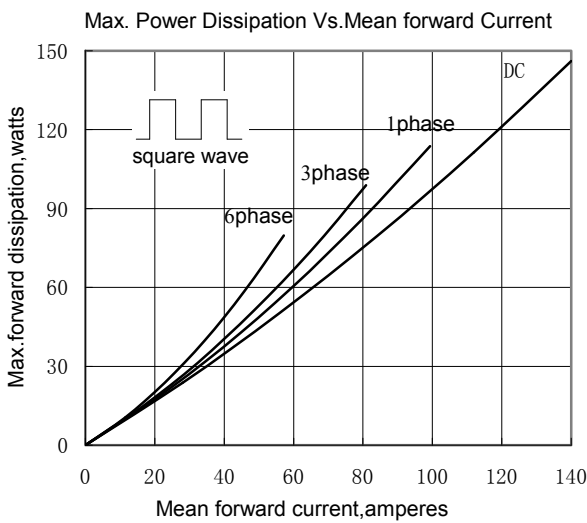
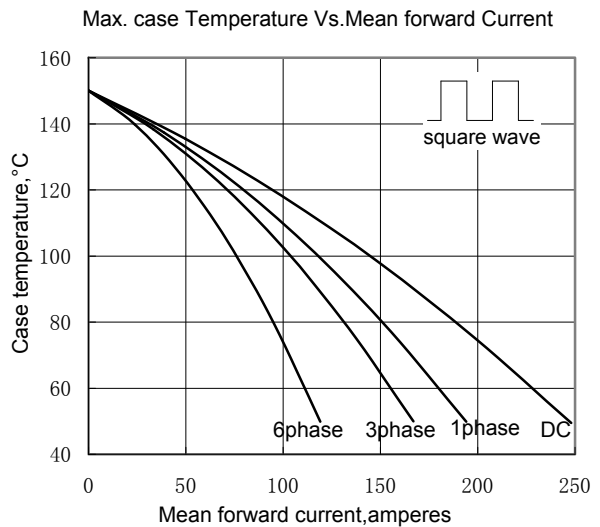
Fig.1

Fig.2

Fig.3

Fig.4

Fig.5

Fig.6

Surge Current Vs.Cycles

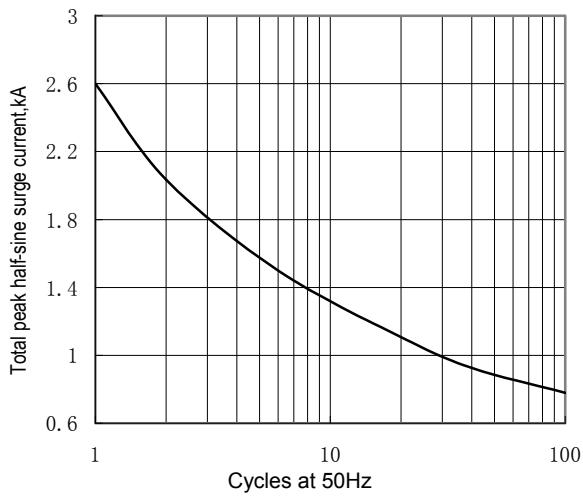

Fig.7

 I^2t Vs.Time

Fig.8

Outline:

M01H

X-ON Electronics

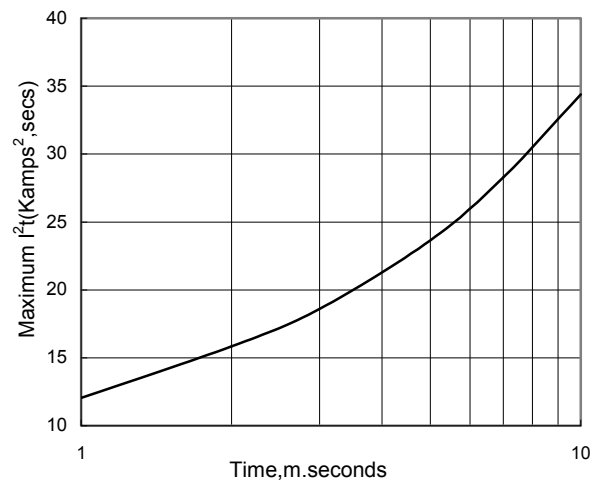
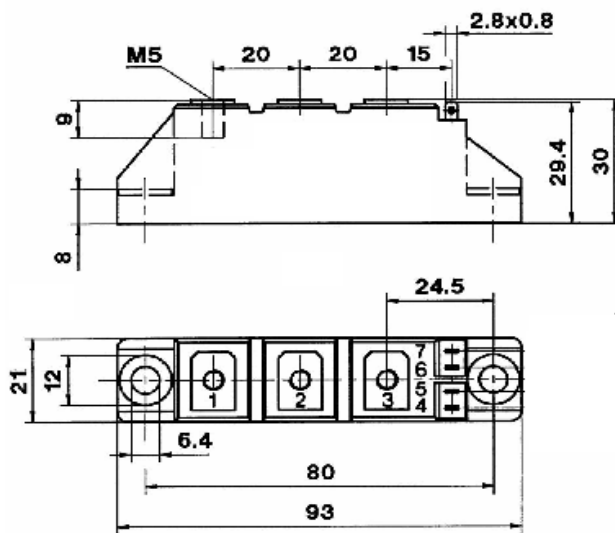
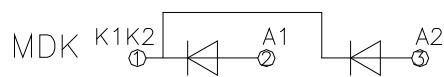
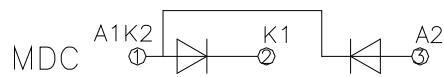
Largest Supplier of Electrical and Electronic Components

Click to view similar products for [Schottky Diodes & Rectifiers](#) category:

Click to view products by [Luguang](#) manufacturer:

Other Similar products are found below :

[CUS06\(Te85L,Q,M\)](#) [MA4E2508M-1112](#) [D1FH3-5063](#) [MBR0530L-TP](#) [MBR10100CT-BP](#) [MBR30H100MFST1G](#) [MMBD301M3T5G](#)
[PMAD1103-LF](#) [PMAD1108-LF](#) [RB160M-50TR](#) [RB520S-30](#) [RB551V-30](#) [D83C](#) [DD350N18K](#) [DZ435N40K](#) [DZ600N16K](#)
[BAS16E6433HTMA1](#) [BAS 3010S-02LRH E6327](#) [BAT 15-099R E6327](#) [BAT 54-02LRH E6327](#) [NRVBAF360T3G](#) [NRVTS10100MFST1G](#)
[NRVTS12100EMFST1G](#) [NSR05F40QNXT5G](#) [NSVR05F40NXT5G](#) [JANS1N6640](#) [SB07-03C-TB-H](#) [SB1003M3-TL-W](#) [SBAT54CWT1G](#)
[SK32A-LTP](#) [SK33A-TP](#) [SK34A-TP](#) [SK34B-TP](#) [SMD1200PL-TP](#) [ACDBN160-HF](#) [SS3003CH-TL-E](#) [STPS3045CPIRG](#) [STPS30S45CW](#)
[PDS3100Q-7](#) [GA01SHT18](#) [CRS10I30A\(Te85L,QM\)](#) [CRS10I30B\(Te85L,QM\)](#) [MBR1240MFST1G](#) [MBR20100CT-BP](#) [MBRB30H30CT-1G](#)
[BAS28E6433HTMA1](#) [BAS 70-02L E6327](#) [BYS11-90-E3TR3](#) [JANTX1N5712-1](#) [VS-STPS40L45CW-N3](#)