

GT4-OSL lenses for Osram's Oslon SSL series of LEDs



- Specially designed for Osram's Oslon SSL series of LEDs.
- Special care taken to make a uniform white or warm white illumination. Lenses work well with other colors, too.
- Lens material optical grade PMMA. Allows use of high current and temperature conditions
- Best available optical efficiency, up to 90%.

LENS TYPES

NAME	ORDERING CODE	FWHM
GT4-OSL Smooth Spot	C10921_GT4-OSL-S	±10°
GT4-OSL Medium	C10922_GT4-OSL-M	±14°
GT4-OSL Wide	C10923_GT4-OSL-W	±16°
GT4-OSL WW	C10975_GT4-OSL-WW	±22°

© Ledil Oy – PRELIMINARY - Subject to change without prior notice

MEASUREMENT DATA

Relative Intensity of C10921_GT4-OSL-S

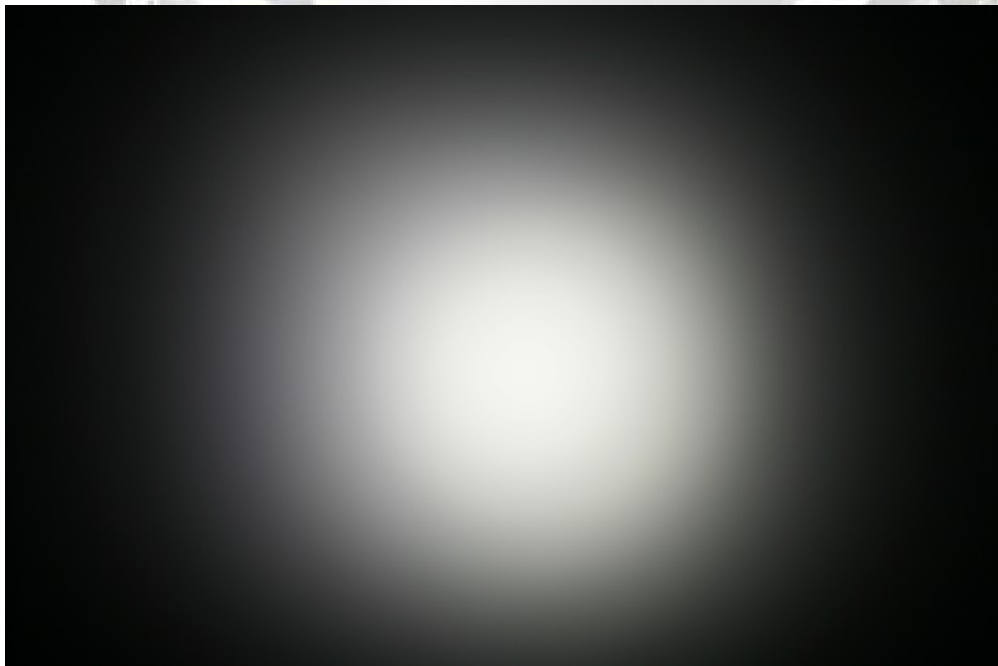
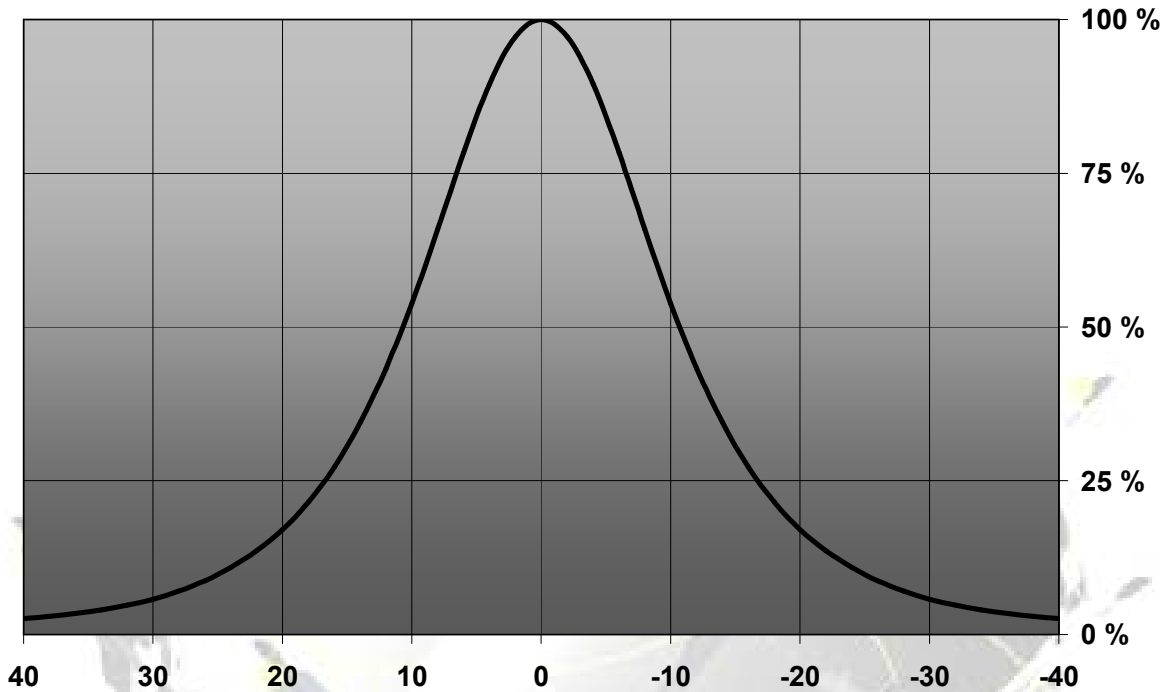

© Ledil Oy – PRELIMINARY - Subject to change without prior notice

Relative Intensity of C10922_GT4-OSL-M

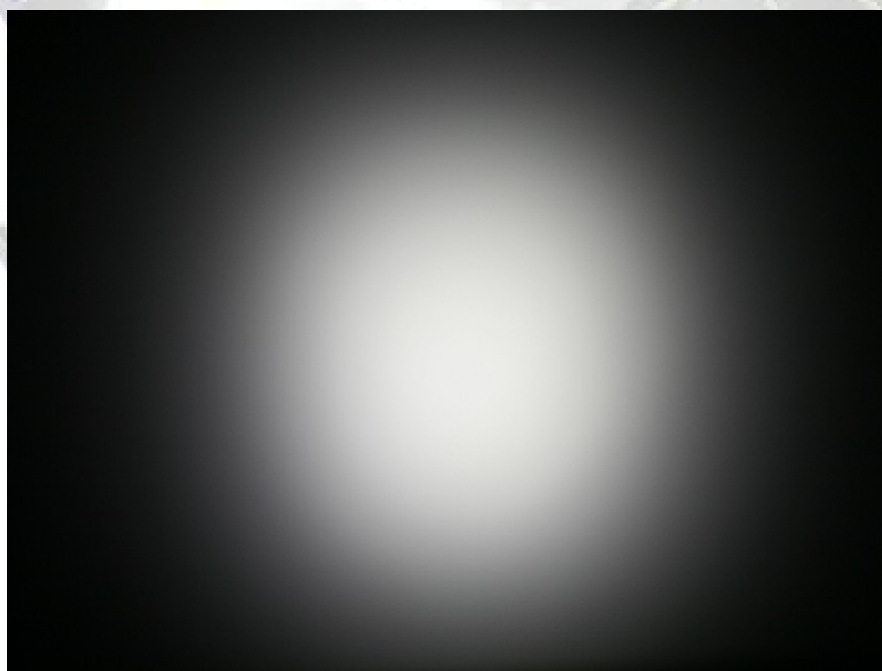
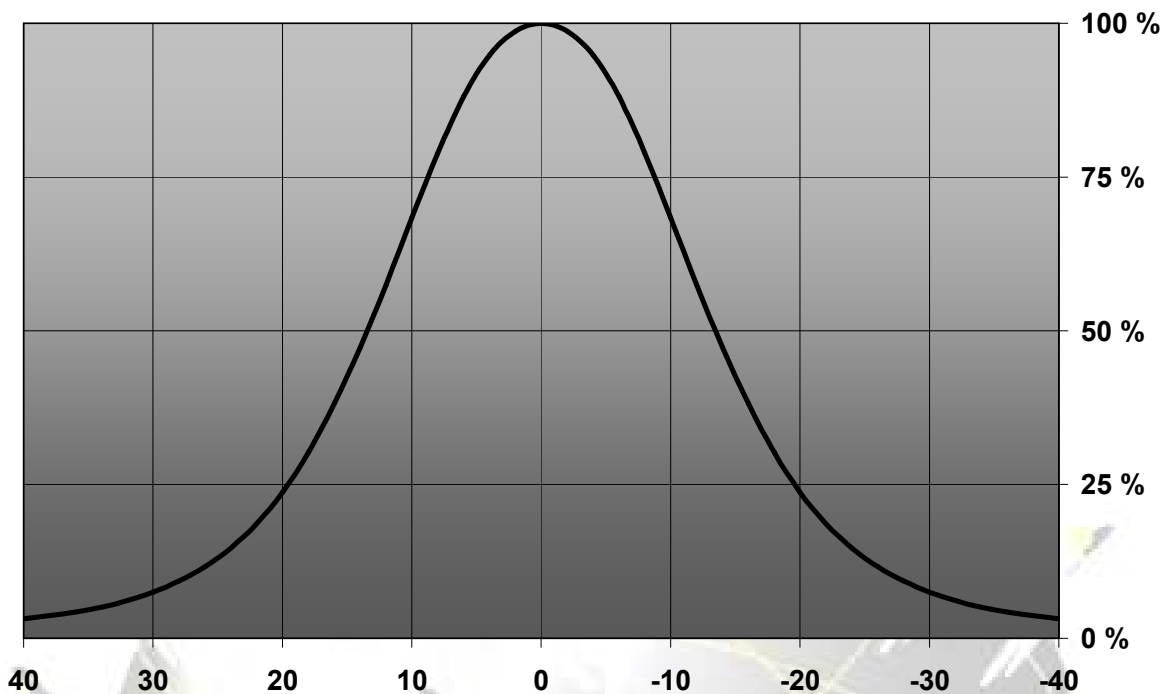

© Ledil Oy – PRELIMINARY - Subject to change without prior notice

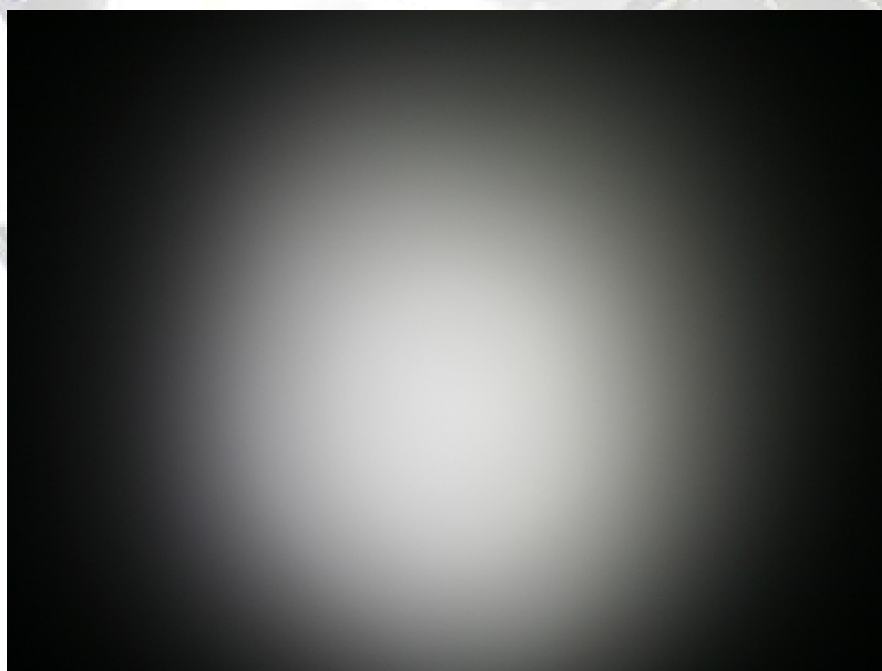
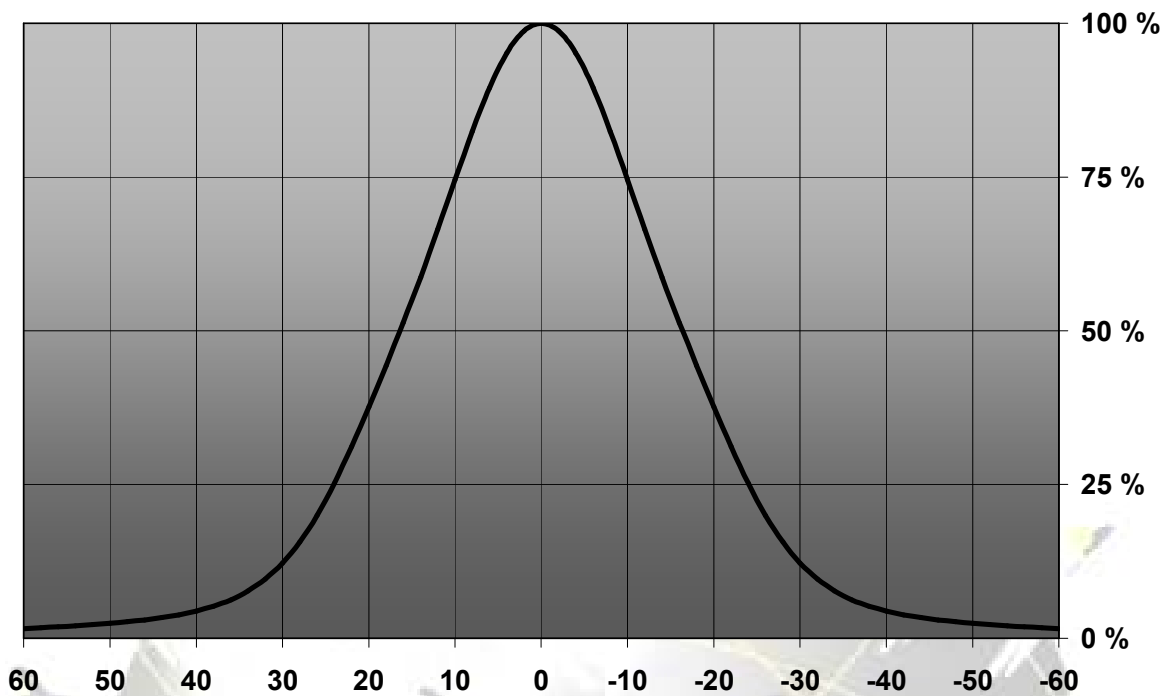
Relative Intensity of C10923_GT4-OSL-W

© Ledil Oy – PRELIMINARY - Subject to change without prior notice

Relative Intensity of C10975_GT4-OSL-WW

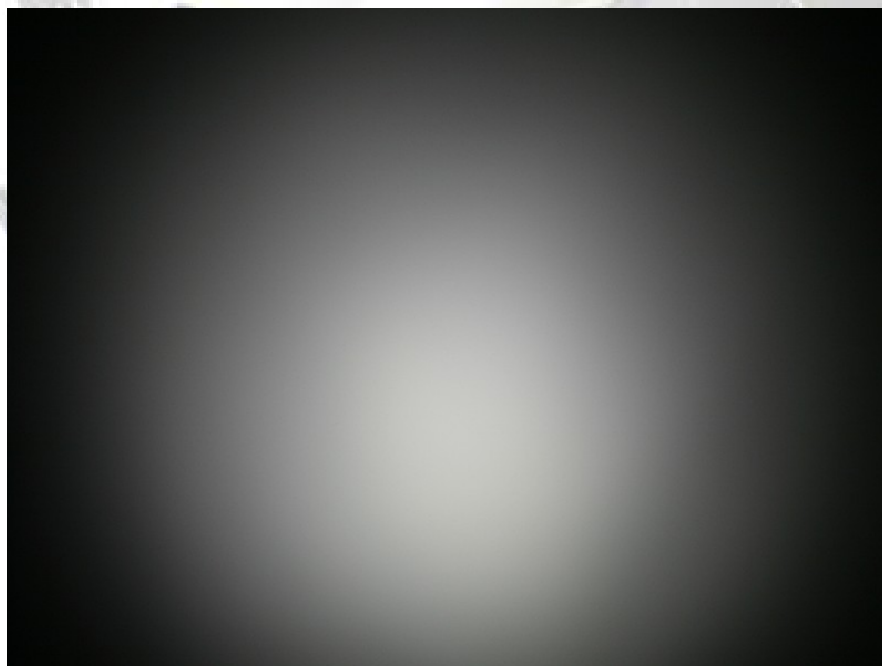
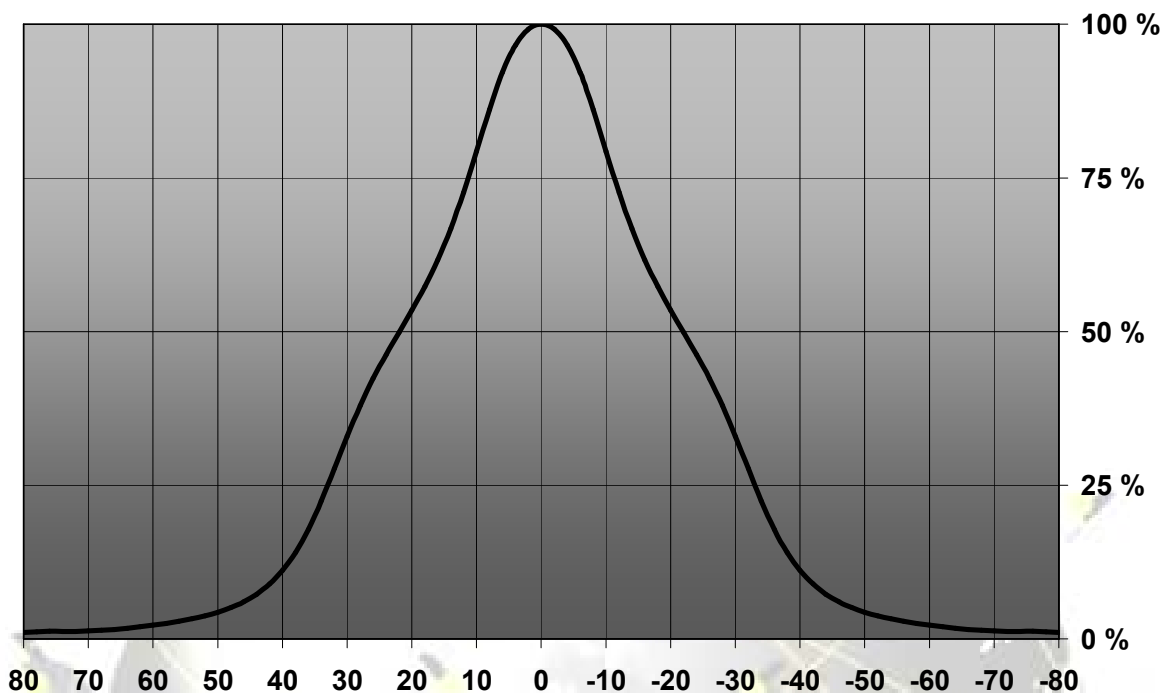

© Ledil Oy – PRELIMINARY - Subject to change without prior notice

DRAWINGS

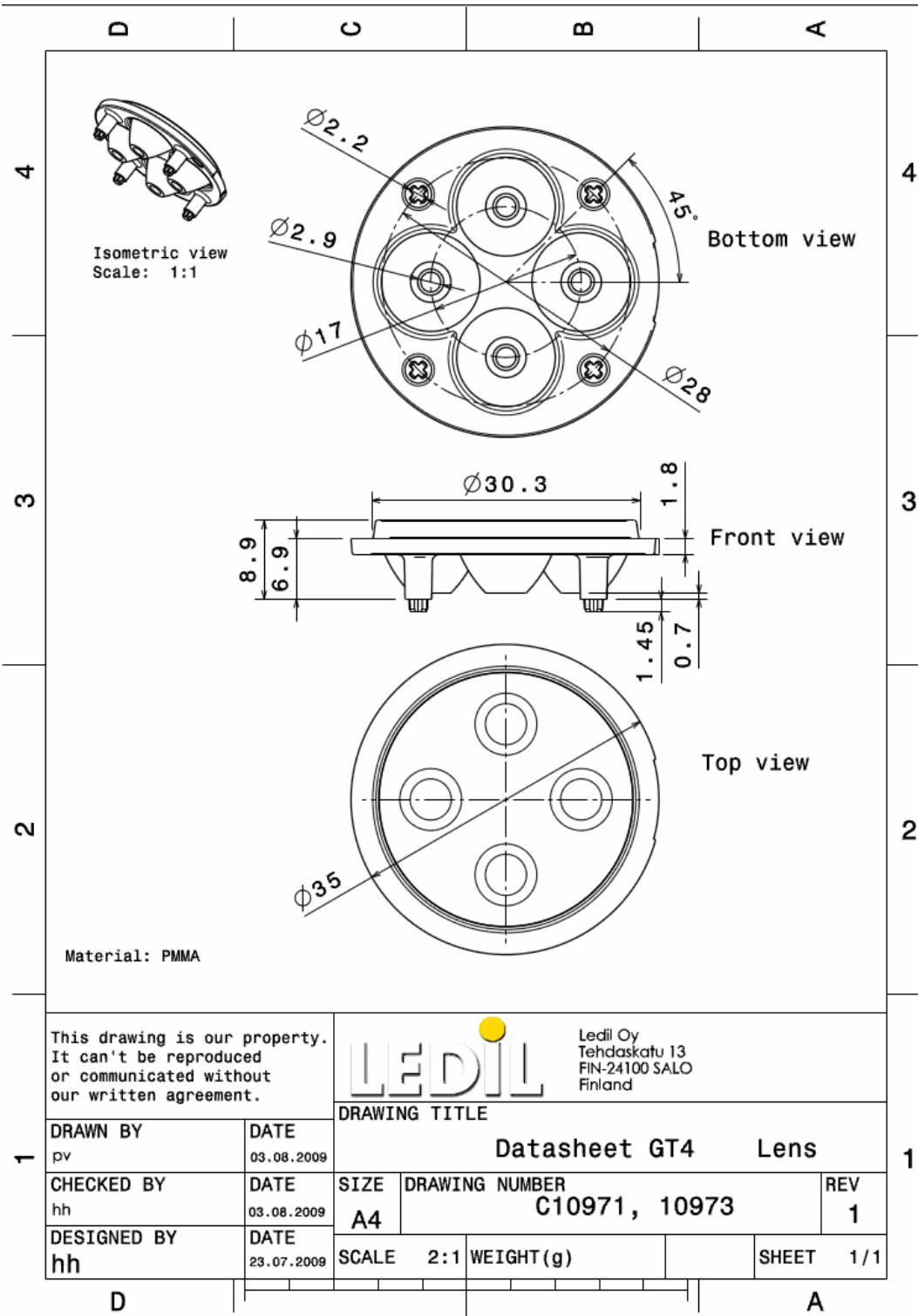

© Ledil Oy – PRELIMINARY - Subject to change without prior notice

X-ON Electronics

Largest Supplier of Electrical and Electronic Components

Click to view similar products for [Ledil](#) manufacturer:

Other Similar products are found below :

[F10390_PENTA-5-M](#) [C10472_RER-5-M](#) [FCN10804_LR1-RS](#) [FCN11454_LE1-M2](#) [C10365_PLATINUMROCKET-3-W](#)
[C12084_BROOKE-SCR-W](#) [FA10643_TINA-M](#) [C12449_STRADA-T-6X1-DWC](#) [C10686_EVA-W](#) [C11552_BARBARA-S](#)
[CA11264_HEIDI-D](#) [CN12644_LENINA-S](#) [CS14840_HB-2X2MX-M](#) [F14533_ANGELETTE-M](#) [F15244_FLORENCE-ZT25-S](#)
[CN17052_DAISSY-7X1-WW-MATT](#) [C17171_DAISSY-8X1-SHD-MATT](#) [FA11207_TINA-W](#) [FCP13895_SEANNA-A](#) [CN14236_WINNIE-S](#)
[C11795_ANNA-40-4-W](#) [C12358_TYRA3-W](#) [C13508_STRADA-SQ-T2](#) [CP10961_RGBX-SS](#) [CN12646_LENINA-W](#) [CP15304_LARISA-](#)
[RS-PIN](#) [FN13888_BILLIE-A](#) [CP16939_CARMEN-W-C-WHT](#) [C17341_DAISSY-4X1-WW-US-D](#) [C14275_SHELLY-T-6X1-N](#)
[C14346_ANGELETTE-WAS](#) [CA11998_EMILY-SS-WAS](#) [CA12000_EMILY-O-WAS](#) [C13032_BARBARA-WW](#) [C15800_MOLLY-S](#)
[FCN12592_LE1-D-COP](#) [CA12242_HEIDI-SS](#) [CP13682_RGBX2-S](#) [CA11476"TYRA2-M](#) [FS15626_FLORENCE-3R-IP-Z90](#)
[F12916_CRYSTAL-RS](#) [C17172_DAISSY-8X1-SHD-MATT-WHT](#) [C17174_DAISSY-4X1-W-US](#) [CA11267_HEIDI-O-90](#) [CA12878_MIRA-M](#)
[CP12413_LOS-D](#) [CP10944_RGBX-M](#) [FA10661"LXP-RS](#) [FCP15347_FLORENTINA-4X1-O](#) [CN12721_LENA-S-DL](#)