



## FRED Modules

**V<sub>RRM</sub>** 600V

**I<sub>FAV</sub>** 100 A

### Applications

- Inversion Welder
- Uninterruptible Power Supply (UPS)
- Plating Power Supply
- Ultrasonic Cleaner and Welder
- Power Factor Correction (PFC) Circuit
- Converter & Chopper

### Features

- Soft Reverse Recovery Characteristics
- Ultrafast Reverse Recovery Time
- Low Reverse Recovery Loss
- Low Forward Voltage
- High Surge Current Capability
- Low Inductance Package

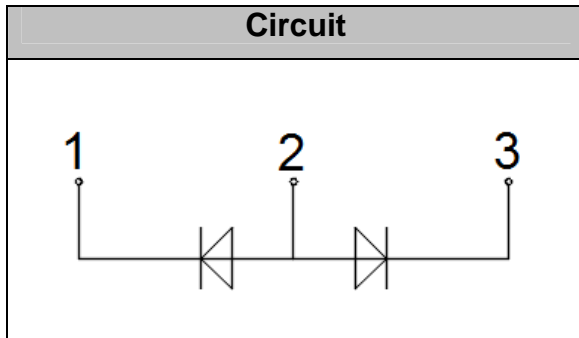

### Module Type

TYPE	V <sub>RRM</sub>	V <sub>RSM</sub>
MF100A06F2N	600V	660V

### Maximum Ratings

Symbol	Conditions	Values	Units
V <sub>R</sub>		600	V
V <sub>RRM</sub>		600	V
I <sub>F(AV)</sub>	T <sub>C</sub> =95°C, Per Diode	100	A
I <sub>F(RMS)</sub>	T <sub>C</sub> =95°C, Per Diode	150	A
I <sub>FSM</sub>	1/2 Cycle, 50Hz, Sine	1300	A
	1/2 Cycle, 60Hz, Sine	1425	A
I <sup>2</sup> t	T <sub>J</sub> =45°C, t=10ms, 50Hz, Sine	8450	A <sup>2</sup> s
P <sub>D</sub>		280	W
Visol	AC, Ton=1min	3000	V
T <sub>J</sub>		-40 to +150	°C
T <sub>STG</sub>		-40 to +125	°C
Torque	Recommended (M6)	4.5 ± 15%	N·m
Torque	Recommended (M6)	4.5 ± 15%	N·m
Weight		160	g

### Thermal Characteristics

Symbol	Conditions	Values	Units
R <sub>th(j-c)</sub>	Per diode	0.22	°C/W



**Electrical Characteristics**

Symbol	Conditions	Values			Units
		Min.	Typ.	Max.	
$I_{RM}$	$V_R=600V$	--	--	50	$\mu A$
	$V_R=600V, T_J=125^\circ C$	--	--	1	mA
$V_F$	$I_F=100A$	--	1.25	1.4	V
	$I_F=100A, T_J=125^\circ C$	--	1.1	1.3	V
trr	$I_F=1A, V_R=30V, di_F/dt=-200A/\mu s$	--	45	50	ns
trr	$V_R=300V, I_F=100A, di_F/dt=-200A/\mu s, T_J=25^\circ C$	--	105	--	ns
$I_{RRM}$		--	10	--	A
trr	$V_R=300V, I_F=100A, di_F/dt=-200A/\mu s, T_J=125^\circ C$	--	200	--	ns
$I_{RRM}$		--	18	--	A

**Performance Curves**

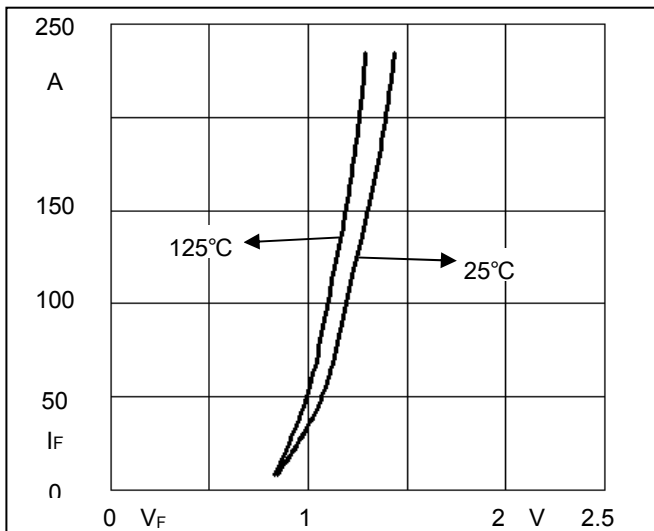

**Fig1. Forward Voltage Drop vs Forward Current**

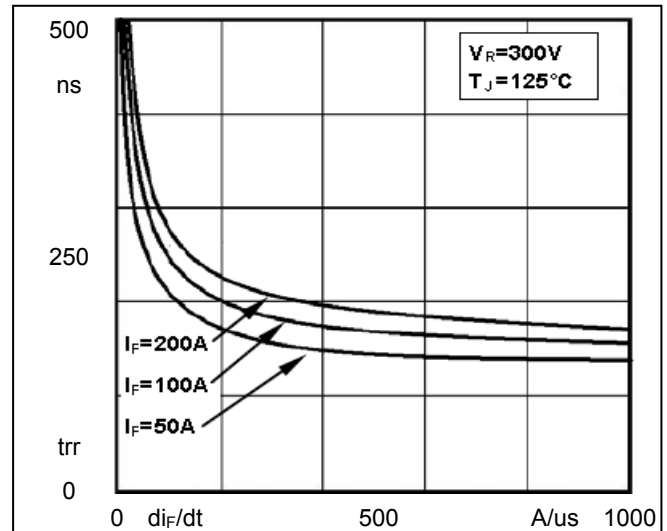

**Fig2. Reverse Recovery Time vs  $di_F/dt$**

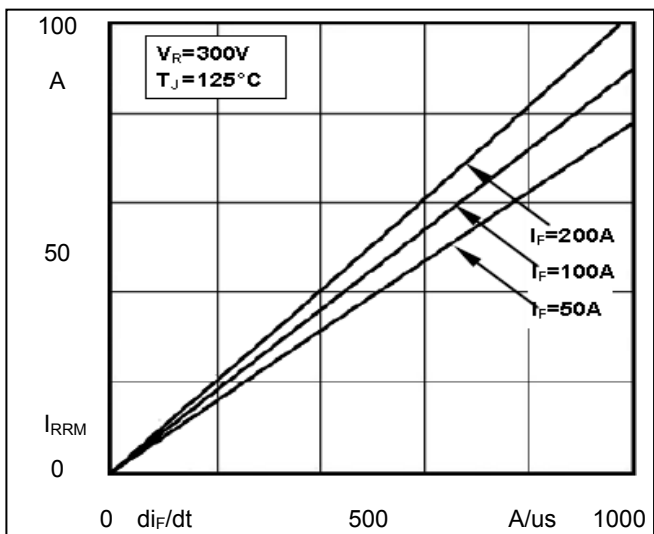

**Fig3. Reverse Recovery Current vs  $di_F/dt$**

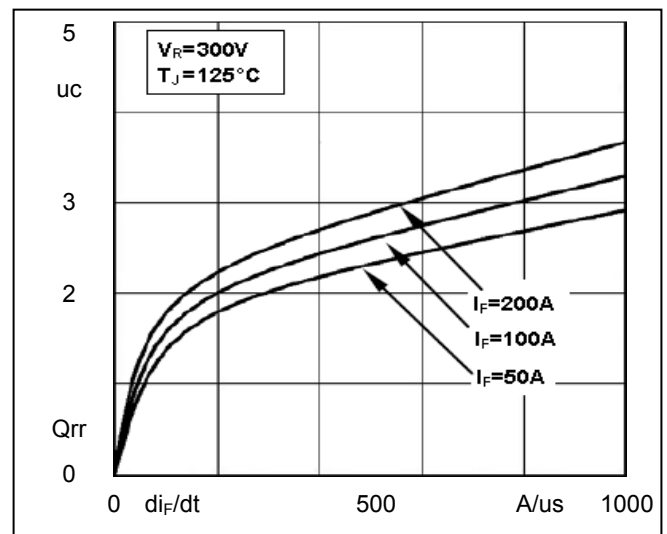
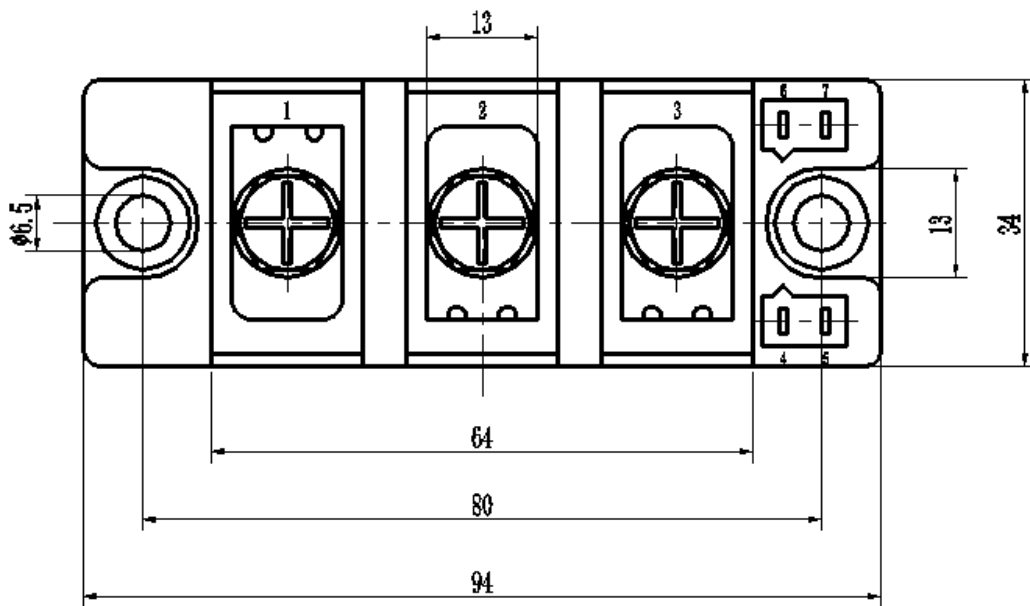
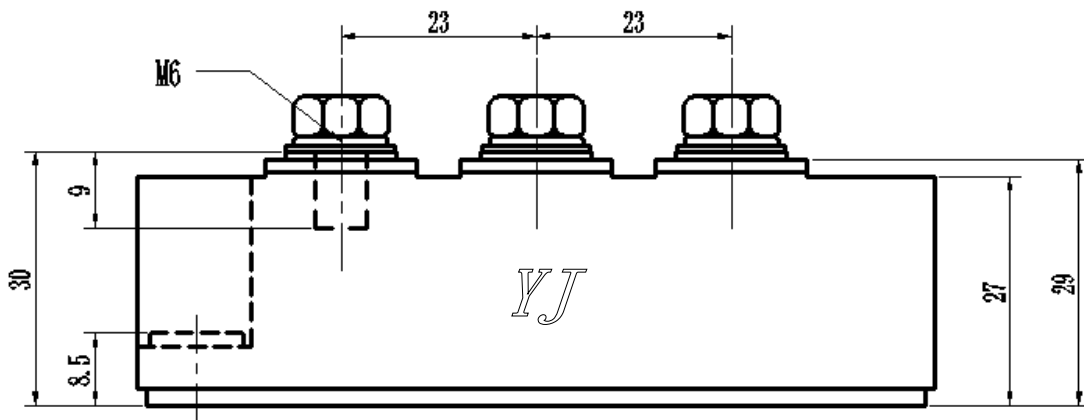

**Fig4. Reverse Recovery Charge vs  $di_F/dt$**



Package Outline Information

CASE: F2N



Dimensions in mm

## X-ON Electronics

Largest Supplier of Electrical and Electronic Components

*Click to view similar products for [Schottky Diodes & Rectifiers](#) category:*

*Click to view products by [Yangjie](#) manufacturer:*

Other Similar products are found below :

[CUS06\(TE85L,Q,M\)](#) [MA4E2508M-1112](#) [D1FH3-5063](#) [MBR0530L-TP](#) [MBR10100CT-BP](#) [MBR30H100MFST1G](#) [MMBD301M3T5G](#)  
[PMAD1103-LF](#) [PMAD1108-LF](#) [RB160M-50TR](#) [RB520S-30](#) [RB551V-30](#) [D83C](#) [DD350N18K](#) [DZ435N40K](#) [DZ600N16K](#)  
[BAS16E6433HTMA1](#) [BAS 3010S-02LRH E6327](#) [BAT 15-099R E6327](#) [BAT 54-02LRH E6327](#) [NRVBAF360T3G](#) [NRVTS10100MFST1G](#)  
[NRVTS12100EMFST1G](#) [NSR05F40QNXT5G](#) [NSVR05F40NXT5G](#) [JANS1N6640](#) [SB07-03C-TB-H](#) [SB1003M3-TL-W](#) [SBAT54CWT1G](#)  
[SK32A-LTP](#) [SK33A-TP](#) [SK34A-TP](#) [SK34B-TP](#) [SMD1200PL-TP](#) [ACDBN160-HF](#) [SS3003CH-TL-E](#) [STPS3045CPIRG](#) [STPS30S45CW](#)  
[PDS3100Q-7](#) [GA01SHT18](#) [CRS10I30A\(TE85L,QM\)](#) [CRS10I30B\(TE85L,QM\)](#) [MBR1240MFST1G](#) [MBR20100CT-BP](#) [MBRB30H30CT-1G](#)  
[BAS28E6433HTMA1](#) [BAS 70-02L E6327](#) [BYS11-90-E3TR3](#) [JANTX1N5712-1](#) [VS-STPS40L45CW-N3](#)