



FRED Modules

V_{RRM} 1200V
I_{FAV} 2×60A

Applications

- Inversion Welder
- Uninterruptible Power Supply (UPS)
- Plating Power Supply
- Ultrasonic Cleaner and Welder
- Power Factor Correction (PFC) Circuit
- Converter & Chopper

Features

- Soft Reverse Recovery Characteristics
- Ultrafast Reverse Recovery Time
- Low Reverse Recovery Loss
- Low Forward Voltage
- High Surge Current Capability
- Popular SOT-227 Package

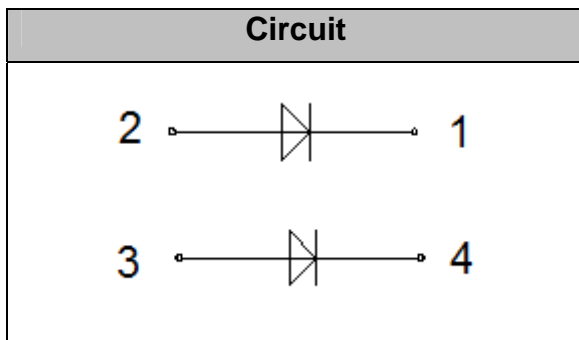

Maximum Ratings

Symbol	Conditions	Values	Units
V _R		1200	V
V _{RRM}		1200	V
I _{F(AV)}	T _C =90°C, Per Leg	60	A
	T _C =90°C, Per Module	120	A
I _{F(RMS)}	T _C =90°C, Per Leg	84	A
I _{FSM}	1/2 Cycle, 50Hz, Sine	500	A
	1/2 Cycle, 60Hz, Sine	550	A
I ² t	T _J =45°C, t=10ms, 50Hz, Sine	1250	A ² s
	T _J =45°C, t=8.3ms, 60Hz, Sine	1512	A ² s
P _D	T _C =25°C	208	W
T _J		-40 to +150	°C
T _{STG}		-40 to +125	°C
Visol	3600V AC 1s	1	mA
Torque	To Sink Recommended (M4)	0.7~1.1	N·m
Torque	To Terminal Recommended (M4)	0.7~1.1	N·m
Weight		26.5	g

Thermal Characteristics

Symbol	Conditions	Values	Units
R _{th(j-c)}	Per diode	0.6	°C/W



Electrical Characteristics

Symbol	Conditions	Values			Units
		Min.	Typ.	Max.	
I_{RM}	$V_R=1200V$	--	--	0.5	mA
	$V_R=1200V, T_J=125^\circ C$	--	--	5	mA
V_F	$I_F=60A$	--	2.10		V
	$I_F=60A, T_J=125^\circ C$	--	1.75		V
t_{rr}	$I_F=1A, V_R=30V, di_F/dt=-200A/\mu s$	--	40	50	ns
t_{rr}	$V_R=600V, I_F=60A, di_F/dt=-200A/\mu s, T_J=25^\circ C$	--	90	--	ns
I_{RRM}		--	7.5	--	A
t_{rr}	$V_R=600V, I_F=60A, di_F/dt=-200A/\mu s, T_J=125^\circ C$	--	320	--	ns
I_{RRM}		--	14	--	A

Performance Curves

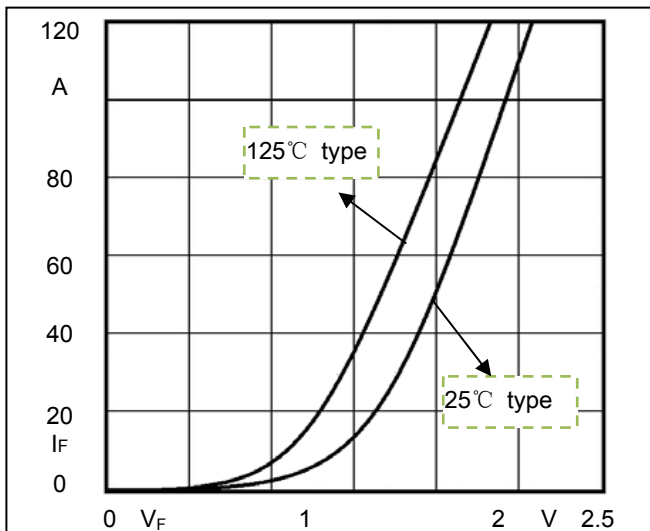

Fig1. Forward Voltage Drop vs Forward Current

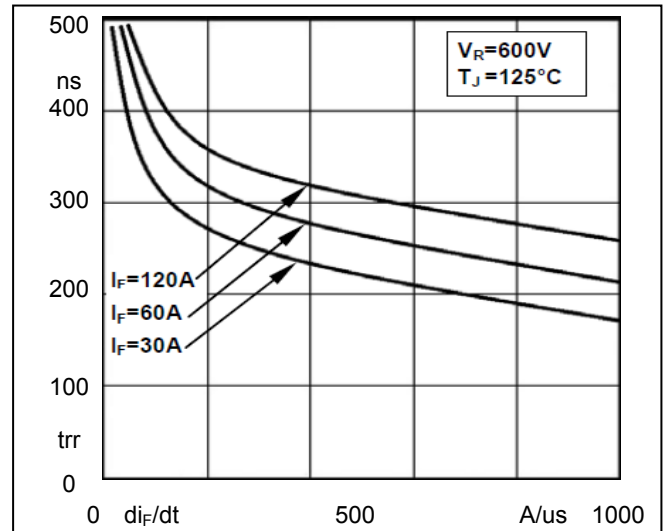

Fig2. Reverse Recovery Time vs di_F/dt

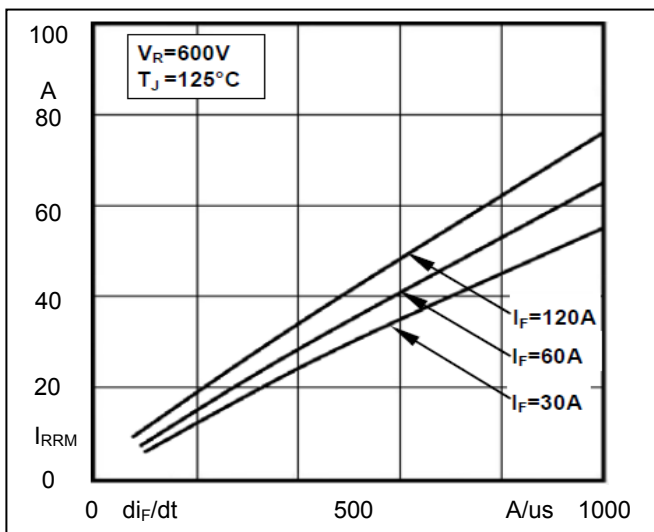

Fig3. Reverse Recovery Current vs di_F/dt

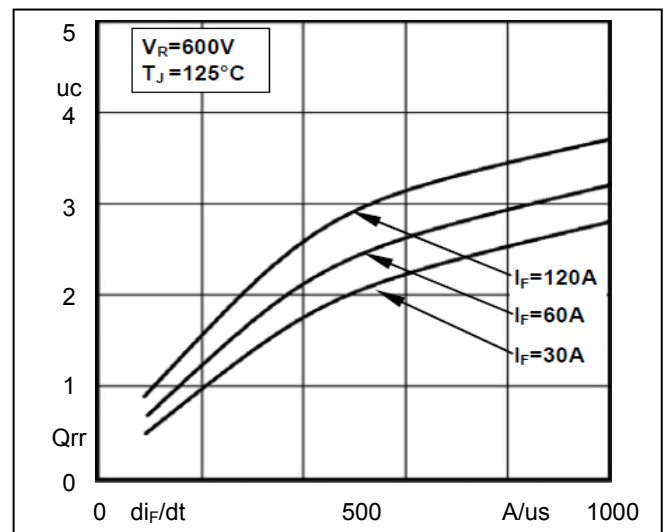

Fig4. Reverse Recovery Charge vs di_F/dt

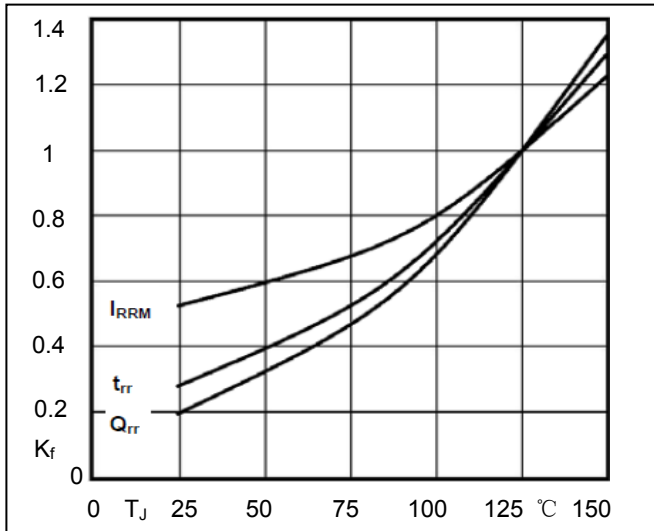

Fig5. Dynamic Parameters vs Junction Temperature

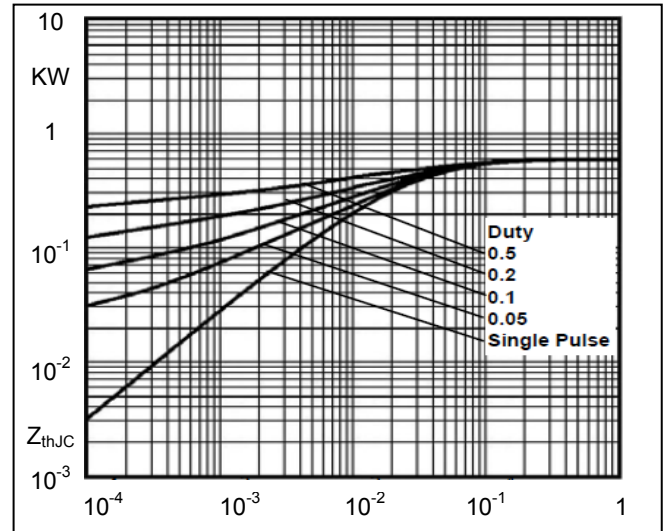
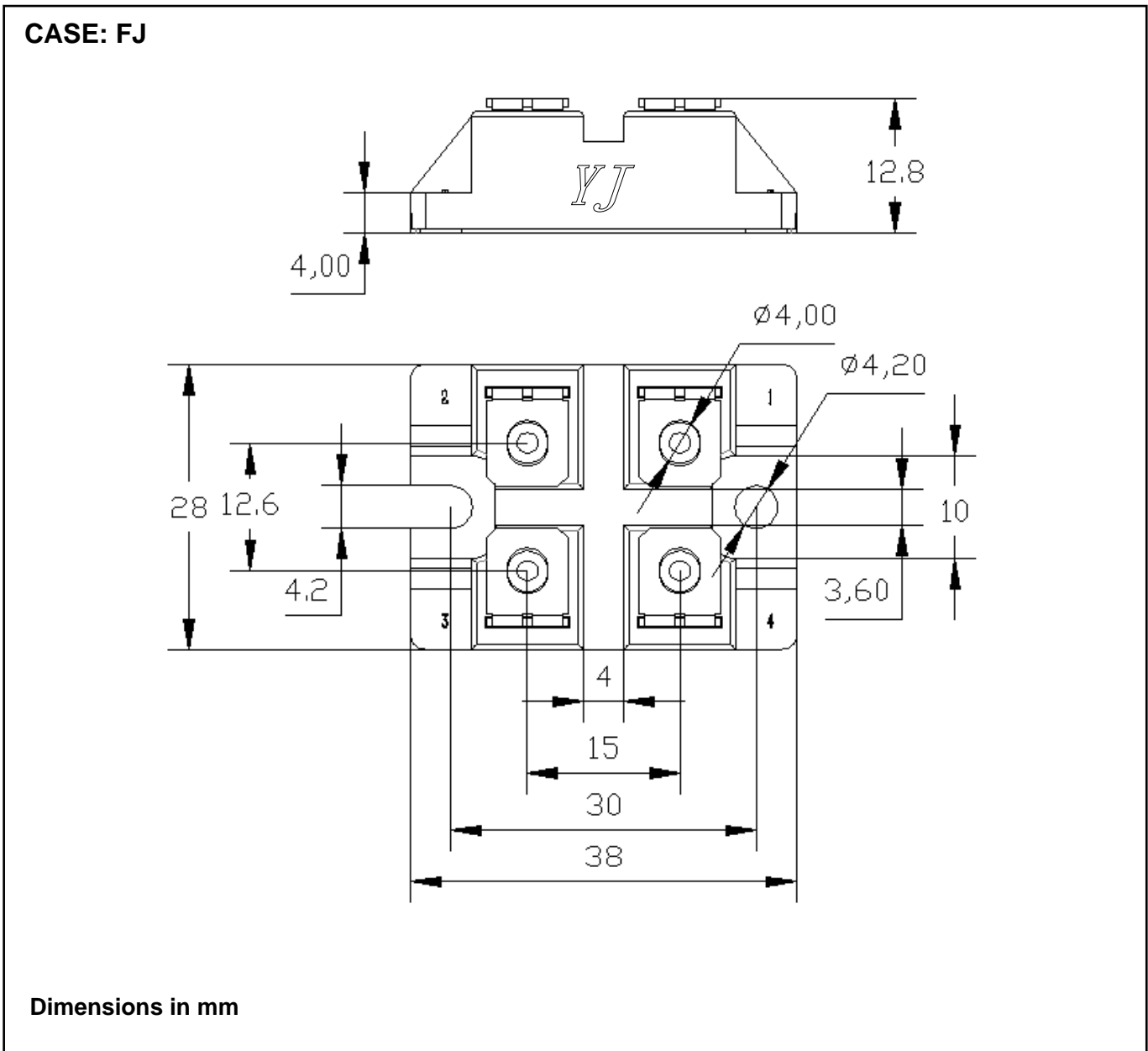

Fig6. Transient Thermal Impedance

Package Outline Information



X-ON Electronics

Largest Supplier of Electrical and Electronic Components

Click to view similar products for [Schottky Diodes & Rectifiers](#) category:

Click to view products by [Yangjie](#) manufacturer:

Other Similar products are found below :

[CUS06\(Te85L,Q,M\)](#) [MA4E2508M-1112](#) [D1FH3-5063](#) [MBR0530L-TP](#) [MBR10100CT-BP](#) [MBR30H100MFST1G](#) [MMBD301M3T5G](#)
[PMAD1103-LF](#) [PMAD1108-LF](#) [RB160M-50TR](#) [RB520S-30](#) [RB551V-30](#) [D83C](#) [DD350N18K](#) [DZ435N40K](#) [DZ600N16K](#)
[BAS16E6433HTMA1](#) [BAS 3010S-02LRH E6327](#) [BAT 15-099R E6327](#) [BAT 54-02LRH E6327](#) [NRVBAF360T3G](#) [NRVTS10100MFST1G](#)
[NRVTS12100EMFST1G](#) [NSR05F40QNXT5G](#) [NSVR05F40NXT5G](#) [JANS1N6640](#) [SB07-03C-TB-H](#) [SB1003M3-TL-W](#) [SBAT54CWT1G](#)
[SK32A-LTP](#) [SK33A-TP](#) [SK34A-TP](#) [SK34B-TP](#) [SMD1200PL-TP](#) [ACDBN160-HF](#) [SS3003CH-TL-E](#) [STPS3045CPIRG](#) [STPS30S45CW](#)
[PDS3100Q-7](#) [GA01SHT18](#) [CRS10I30A\(Te85L,QM\)](#) [CRS10I30B\(Te85L,QM\)](#) [MBR1240MFST1G](#) [MBR20100CT-BP](#) [MBRB30H30CT-1G](#)
[BAS28E6433HTMA1](#) [BAS 70-02L E6327](#) [BYS11-90-E3TR3](#) [JANTX1N5712-1](#) [VS-STPS40L45CW-N3](#)