

FRED Modules

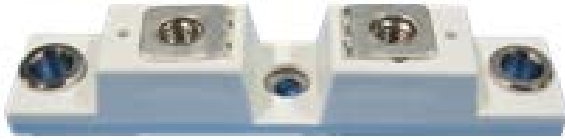

V_{RRM} 400V

I_{FAV} 200 A

Features

- Soft Reverse Recovery Characteristics
- Ultrafast Reverse Recovery Time
- Low Reverse Recovery Loss
- Low Forward Voltage
- High Surge Current Capability
- Low Inductance Package

Applications

- Inversion Welder
- Uninterruptible Power Supply (UPS)
- Plating Power Supply
- Ultrasonic Cleaner and Welder
- Power Factor Correction (PFC) Circuit
- Converter & Chopper

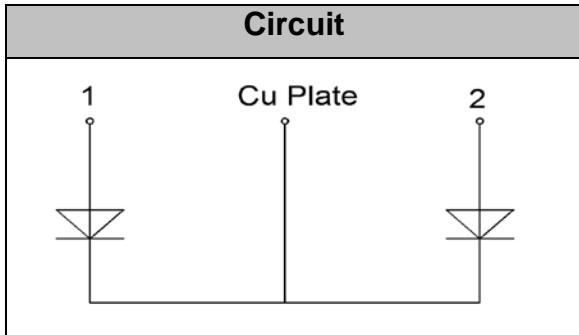

Maximum Ratings

Symbol	Conditions	Values	Units
V_R		400	V
V_{RRM}		400	V
$I_{F(AV)}$	$T_C=125^\circ\text{C}$, Per Diode	100	A
	$T_C=125^\circ\text{C}$, Per Module	200	A
$I_{F(RMS)}$	$T_C=125^\circ\text{C}$, Per Diode	150	A
I_{FSM}	1/2 Cycle, 50Hz, Sine	1500	A
	1/2 Cycle, 60Hz, Sine	1800	A
I^2t	$T_J=45^\circ\text{C}$, $t=10\text{ms}$, 50Hz, Sine	11250	A^2s
	$T_J=45^\circ\text{C}$, $t=8.3\text{ms}$, 60Hz, Sine	16200	A^2s
P_D		833	W
T_J		-40 to +150	$^\circ\text{C}$
T_{STG}		-40 to +125	$^\circ\text{C}$
Torque	Recommended (M6)	3~4.7	N·m
Torque	Recommended (M6)	3~4.7	N·m
Weight		68	g

Thermal Characteristics

Symbol	Conditions	Values	Units
$R_{th(j-c)}$	Per diode	0.15	$^\circ\text{C}/\text{W}$



Electrical Characteristics

Symbol	Conditions	Values			Units
		Min.	Typ.	Max.	
I_{RM}	$V_R=400V$	--	--	0.5	mA
	$V_R=400V, T_J=125^\circ C$	--	--	1	mA
V_F	$I_F=100A$	--	1.1	1.35	V
	$I_F=100A, T_J=125^\circ C$	--	1.0	1.25	V
trr	$I_F=1A, V_R=30V, di_F/dt=-200A/\mu s$	--	38	--	ns
trr	$V_R=200V, I_F=100A, di_F/dt=-200A/\mu s, T_J=25^\circ C$	--	95	--	ns
I_{RRM}		--	8.5	--	A
trr	$V_R=200V, I_F=100A, di_F/dt=-200A/\mu s, T_J=125^\circ C$	--	150	--	ns
I_{RRM}		--	14	--	A

Performance Curves

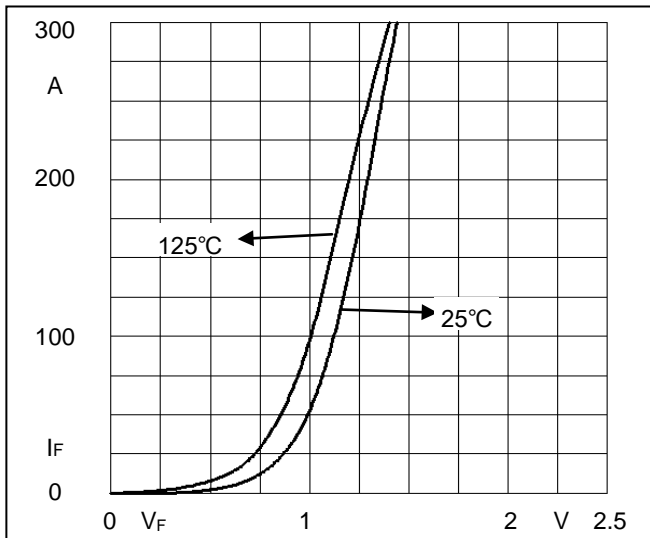

Fig1. Forward Voltage Drop vs Forward Current

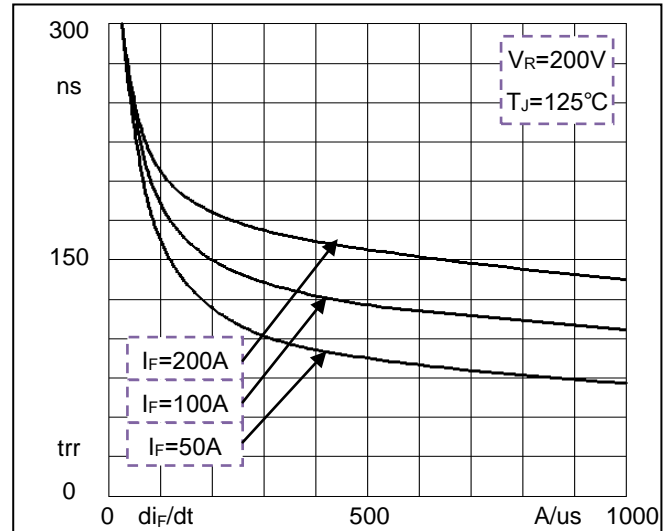

Fig2. Reverse Recovery Time vs di_F/dt

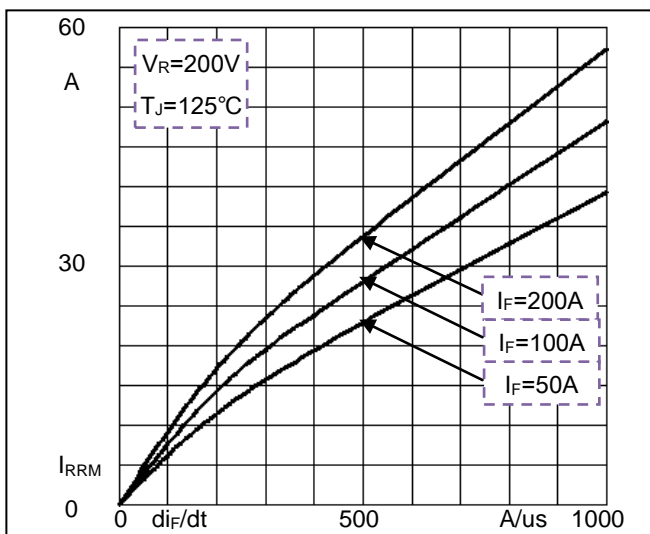

Fig3. Reverse Recovery Current vs di_F/dt

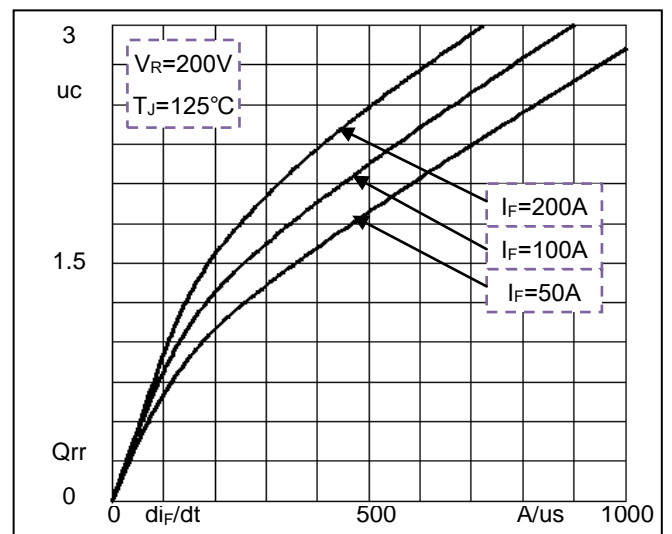
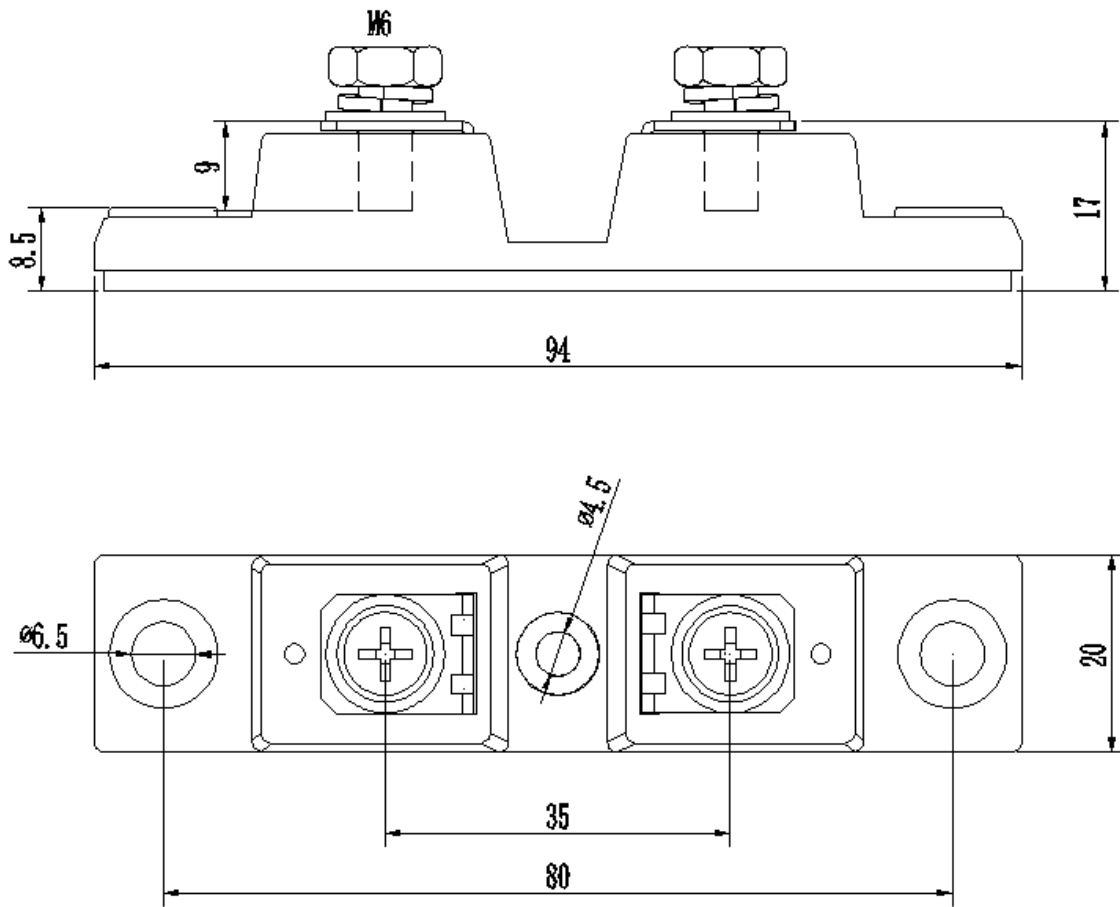

Fig4. Reverse Recovery Charge vs di_F/dt

Package Outline Information

CASE: F4N



Dimensions in mm

X-ON Electronics

Largest Supplier of Electrical and Electronic Components

Click to view similar products for [Schottky Diodes & Rectifiers](#) category:

Click to view products by [Yangjie](#) manufacturer:

Other Similar products are found below :

[CUS06\(Te85L,Q,M\)](#) [MA4E2508M-1112](#) [D1FH3-5063](#) [MBR0530L-TP](#) [MBR10100CT-BP](#) [MBR30H100MFST1G](#) [MMBD301M3T5G](#)
[PMAD1103-LF](#) [PMAD1108-LF](#) [RB160M-50TR](#) [RB520S-30](#) [RB551V-30](#) [D83C](#) [DD350N18K](#) [DZ435N40K](#) [DZ600N16K](#)
[BAS16E6433HTMA1](#) [BAS 3010S-02LRH E6327](#) [BAT 15-099R E6327](#) [BAT 54-02LRH E6327](#) [NRVBAF360T3G](#) [NRVTS10100MFST1G](#)
[NRVTS12100EMFST1G](#) [NSR05F40QNXT5G](#) [NSVR05F40NXT5G](#) [JANS1N6640](#) [SB07-03C-TB-H](#) [SB1003M3-TL-W](#) [SBAT54CWT1G](#)
[SK32A-LTP](#) [SK33A-TP](#) [SK34A-TP](#) [SK34B-TP](#) [SMD1200PL-TP](#) [ACDBN160-HF](#) [SS3003CH-TL-E](#) [STPS3045CPIRG](#) [STPS30S45CW](#)
[PDS3100Q-7](#) [GA01SHT18](#) [CRS10I30A\(Te85L,QM\)](#) [CRS10I30B\(Te85L,QM\)](#) [MBR1240MFST1G](#) [MBR20100CT-BP](#) [MBRB30H30CT-1G](#)
[BAS28E6433HTMA1](#) [BAS 70-02L E6327](#) [BYS11-90-E3TR3](#) [JANTX1N5712-1](#) [VS-STPS40L45CW-N3](#)