

MT4Y/MT4W Series

DIN W72×H36mm, W96×48mm, digital multi panel meter

Features

- Various output options (Default : Indicator)
RS485 Communication output, Low speed serial output, Current (4–20mA), BCD output, NPN/PNP open collector output, Relay output
- Max. measuring input specification :
500VDC, 500VAC, DC5A, AC5A
- Max. display range : -1999 ~ 9999
- High/Low scale function
- **AC frequency measurement function : 0.1~9999Hz**
- Various functions : Monitoring function for max. and min. display value function, Display cycle delay function, **Zero function**, High display correction function, **Current output scale function**
- Wide range of power supply : 12–24VDC, 100–240VAC



 Please read "Caution for your safety" in operation manual before using.



Ordering information

MT 4 W - DV - 4 N

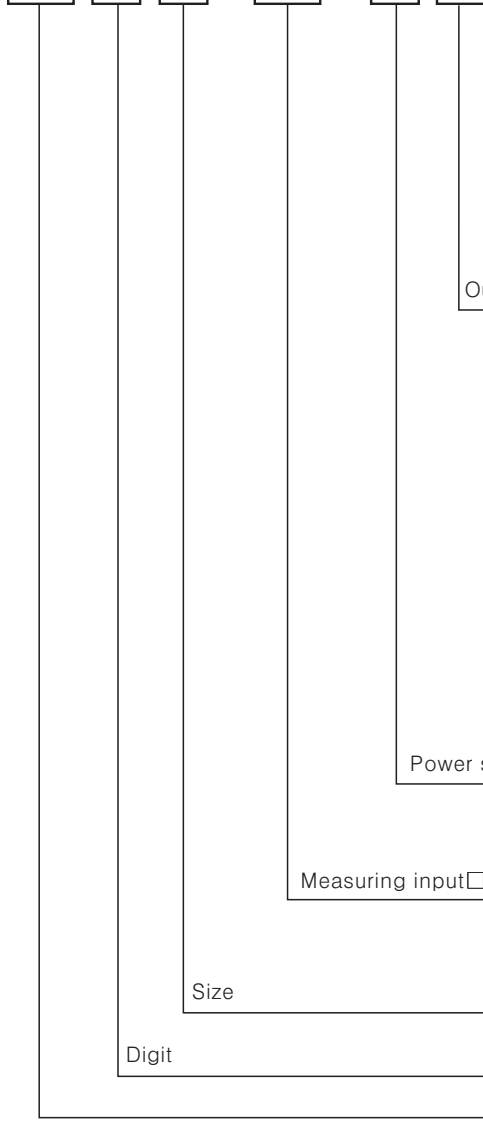

N	Indicator (No output function)
0	Relay contact output
1	NPN open collector output
2	PNP open collector output
3	Relay contact output + Transmission output (DC4–20mA)
4	Relay contact output + RS485 communication output
5	BCD Dynamic output
6	Low speed serial output
*Output (0~6) : Option	
N	Indication type (No output function)
0	Relay contact output + Transmission output (DC4–20mA)
1	Relay contact output
2	NPN open collector output + BCD Dynamic output
3	PNP open collector output + BCD Dynamic output
4	NPN open collector output + Transmission output (DC4–20mA)
5	PNP open collector output + Transmission output (DC4–20mA)
6	NPN open collector output + Low speed serial output
7	PNP open collector output + Low speed serial output
8	NPN open collector output + RS485 output
9	PNP open collector output + RS485 output
*Output (0~9) : Option	
1	12–24VDC
4	100–240VAC
DV	DC Volt
DA	DC Ampere
AV	AC Volt
AA	AC Ampere
Y	DIN W72×H36mm
W	DIN W96×H48mm
4	4digit
MT	Multi Meter

*To measure the current over 5ADC, please select DV type because the shunt should be used.

Multi Panel Meter

Specifications

Series	MT4Y-DV-4□ MT4Y-DA-4□	MT4Y-AV-4□ MT4Y-AA-4□	MT4W-DV-4□ MT4W-DA-4□	MT4W-AV-4□ MT4W-AA-4□	MT4W-DV-1□ MT4W-DA-1□	MT4W-AV-1□ MT4W-AA-1□
Measurement function	VDC, ADC	VAC, AAC, Frequency	VDC, ADC	VAC, AAC, Frequency	VDC, ADC	VAC, AAC, Frequency
Power supply	100-240VAC 50/60Hz (90 ~ 110% of rated voltage)				12-24VDC (90 ~ 110% of rated voltage)	
Power consumption	5VA				5W	
Display method	7Segment LED Display (Red) (Character height:14.2mm)					
Display accuracy	23°C ±5°C 35~85%RH	DC Type ⇨ Voltage/Current : ±0.1% F.S ±2Digit AC Type ⇨ Voltage/Current : ±0.3% F.S ±3Digit, Frequency : ±0.1% F.S ±2Digit When ±0.3% F.S ±3Digit only for 5A terminal of MT4Y-DA, AA Type		When ±1.0% F.S ±3Digit only for 5A terminal of MT4W-DA, AA Type		
	-10°C~50°C	DC/AC Type ⇨ Voltage/Current:±0.5% F.S ±3Digit Frequency:±0.1% F.S ±2Digit		DC/AC Type ⇨ Voltage/Current:±0.5% F.S ±3Digit Frequency:±0.1% F.S ±2Digit		
A/D conversion method	Practical Over sampling using successive approximation ADC					
Sampling cycle	DC type:50ms, AC type:16.6ms(Resolution 1/12000)					
Max. indication range	-1999 ~ 9999(4Digit)					
Max. input	110% for input specification					
Main output	Relay output	• Contact capacity : 250VAC 3A, 30VDC 3A • Contact composition: N.O(1a)				
	NPN open collector output	12-24VDC ±2V 50mA Max. (Resistive load)				
	PNP open collector output					
Sub output (Transmission output)	RS485 communication output	• Baud rate : 1200/2400/4800/9600bps • Protocol : RTU type		• Communication type : 2 wires half duplex • Tuning method : Sub-synchronization		
	Serial output	NPN open collector output, 12-24VDC Max. 50mA (Resistive load)				
	BCD output					
	DC4-20mA output	Resolution : 12000 division (Load resistance max. 600Ω)				
AC measuring function	Selectable RMS or AVG					
Hold function	Including(Outer hold function)					
Insulation resistance	Min. 100MΩ (at 500VDC mega) between external terminal and case					
Dielectric strength	2000VAC for 1minute between external terminal and case					
Noise strength	±2kV the square wave noise(pulse width:1μs) by the noise simulator					
Vibration	Mechanical	0.75mm amplitude at frequency of 10 ~ 55Hz in each of X, Y, Z directions for 2hours				
	Malfunction	0.5mm amplitude at frequency of 10 ~ 55Hz in each of X, Y, Z directions for 10minutes				
Shock	Mechanical	100m/s ² (10G) in X, Y, Z directions for 3 times				
	Malfunction	300m/s ² (30G) in X, Y, Z directions for 3 times				
Relay life cycle	Malfunction	Min. 20,000,000 times				
	Mechanical	Min. 100,000 times(250VAC 3A Load current)				
Ambient temperature	-10 ~ +50°C (at non-freezing status)					
Storage temperature	-20 ~ +60°C (at non-freezing status)					
Ambient humidity	35 ~ 85%RH					
Approval	CE C RU US					
Unit weight	Approx. 134g			Approx. 211g		

(A) Counter
(B) Timer
(C) Temp. controller
(D) Power controller
(E) Panel meter
(F) Tacho/Speed/Pulse meter
(G) Display unit
(H) Sensor controller
(I) Switching power supply
(J) Proximity sensor
(K) Photo electric sensor
(L) Pressure sensor
(M) Rotary encoder
(N) Stepping motor & Driver & Controller
(O) Graphic panel
(P) Field network device
(Q) Production stoppage models & replacement

Front panel identification

●MT4Y Series

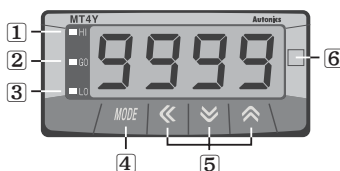

- ① HI : High output indication of preset
- ② GO : GO output indication of preset
- ③ LO : Low output indication of preset

●MT4W Series

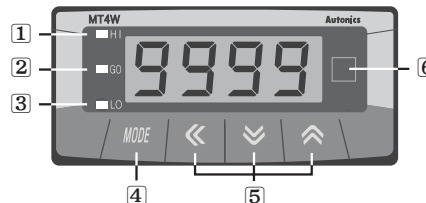

- ④ [MD] key : Enter to parameter group, Memorize the setting value, Move the parameter mode
- ⑤ [Left Arrow] key : Move the digit, Enter to parameter group
- [Down Arrow], [Up Arrow] key : Change the setting value.
- ⑥ Unit sticker

※ There is no ①, ②, ③ on a display panel of MT4Y-□□-4N, 45, 46 and MT4W-□□-4N.

※ In MT4Y-□□-43, 44, OUT is used for Go output display and there is no ①, ③ in display panel.

MT4Y/MT4W Series

■ Connections

◎ Measuring input connection of MT4Y series

● MT4Y-DV-4□

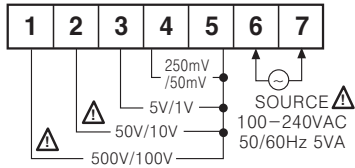

● MT4Y-AV-4□

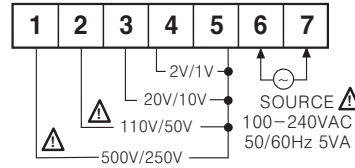

● MT4Y-DA-4□

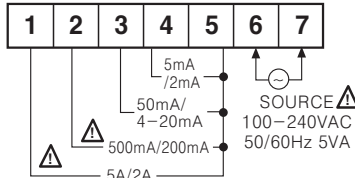

● MT4Y-AA-4□

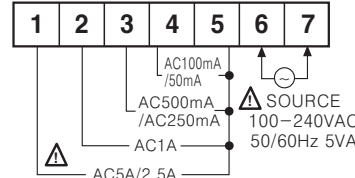

◎ Output terminal of connection of MT4Y Series

● MT4Y-□□-4N (Indicator)

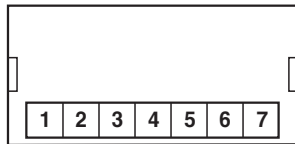

● MT4Y-□□-40

(Triple relay contact output)

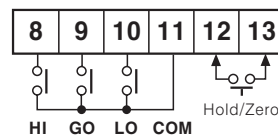

● MT4Y-□□-41

(Triple NPN O.C output)

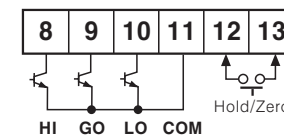

● MT4Y-□□-42

(Triple PNP O.C output)

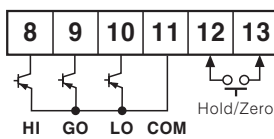

● MT4Y-□□-43

(Relay output+Current output)

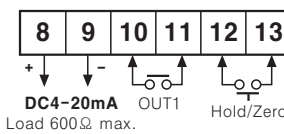

● MT4Y-□□-44

(Relay+RS485 communication output)

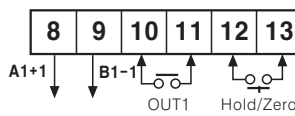

● MT4Y-□□-45

(BCD Dynamic output)

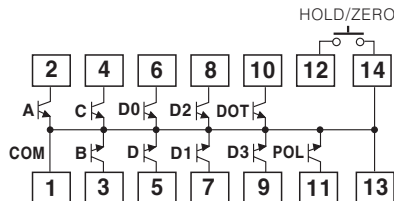

(Note) There is no signal output terminal about - sign.

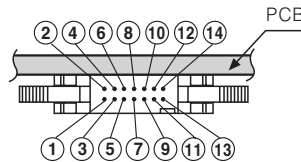

※ Hirose connector pin header model of the unit : HIF3BA-14PA-2.54DS
 ※ Contact Hirose Electric to purchase socket and wires of Hirose connector.
 [Socket : HIF3BA-14D-2.54R]

● MT4Y-□□-46 (Low speed serial output)

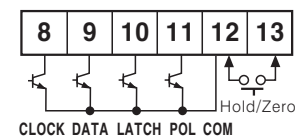

※ POL : When a display value is "-", the signal of "-" will be outputted.

◎ Measuring input connection of MT4W Series

● MT4W-DV-4□

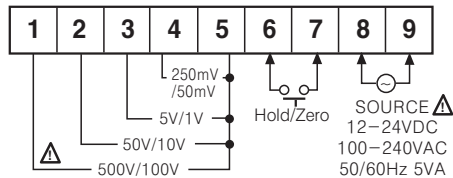

● MT4W-AV-4□

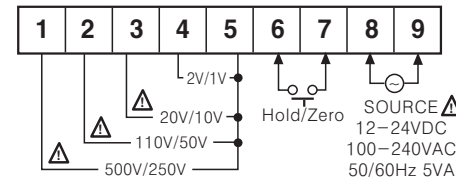

● MT4W-DA-4□

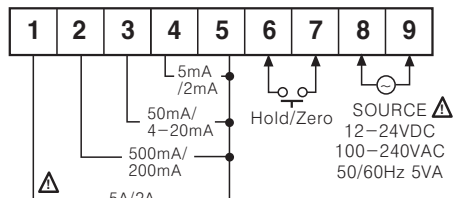

● MT4W-AA-4□

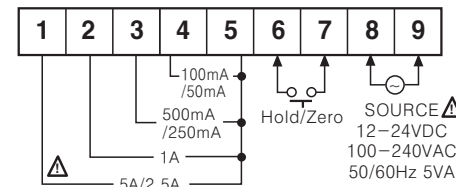

Multi Panel Meter

◎Output terminal connection of MT4W Series

●MT4W-□□-40 (Triple relay contact output + Current output)

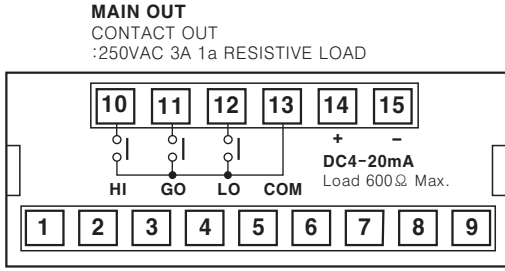

●MT4W-□□-41 (Triple relay contact output)

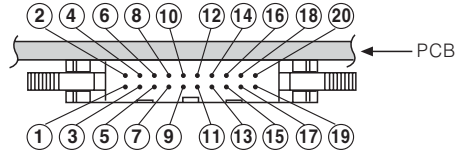
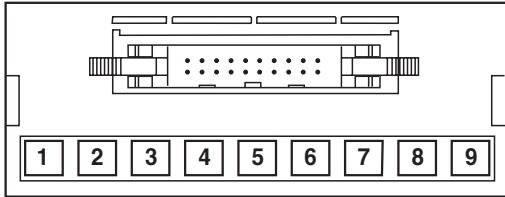
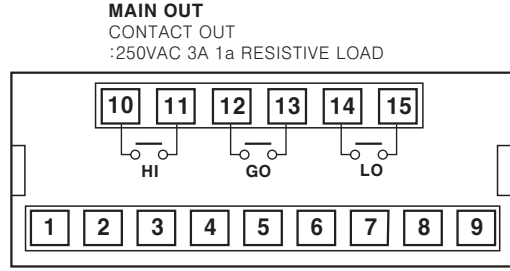

*Hirose connector pin header model of the unit : HIF3BA-20PA-2.54DS
*Contact Hirose Electric to purchase socket and wires of Hirose connector.
[Socket : HIF3BA-20D-2.54R]

●MT4W-□□-42 / MT4W-□□-43 (Triple NPN/PNP open collector output+BCD output)

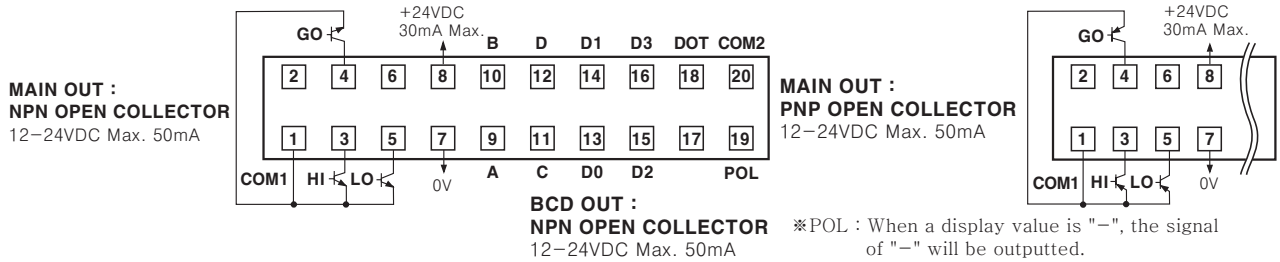

●MT4W-□□-44/ MT4W-□□-45 (Triple NPN/PNP open collector output+Current output)

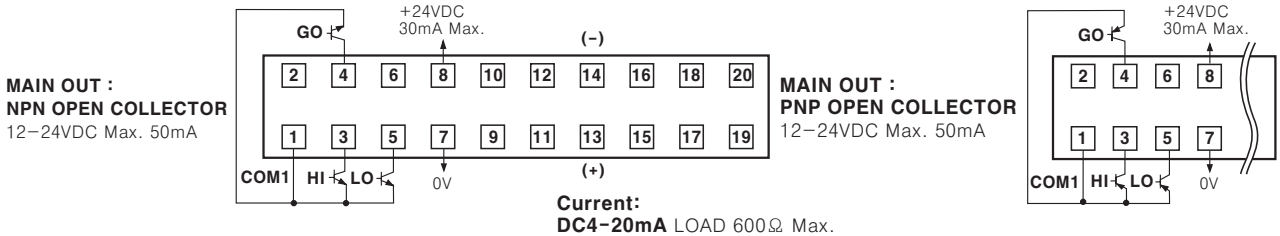

●MT4W-□□-46/ MT4W-□□-47 (Triple NPN/PNP open collector output+Low speed serial output)

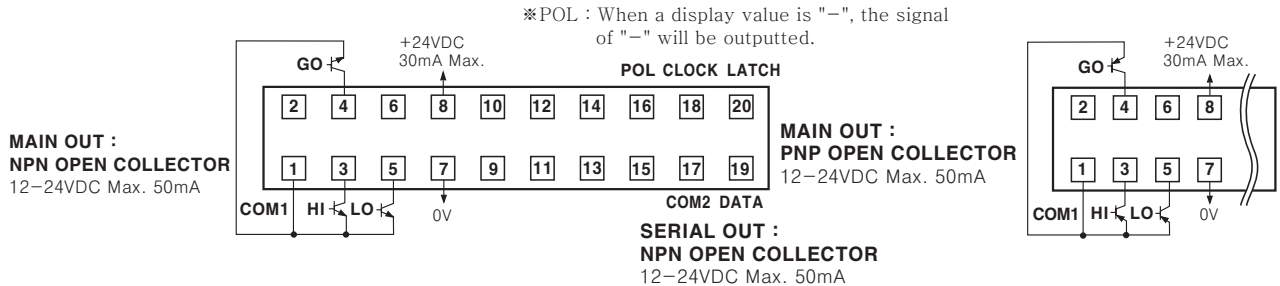

●MT4W-□□-48/ MT4W-□□-49 (Triple NPN/PNP open collector output+RS485 output)

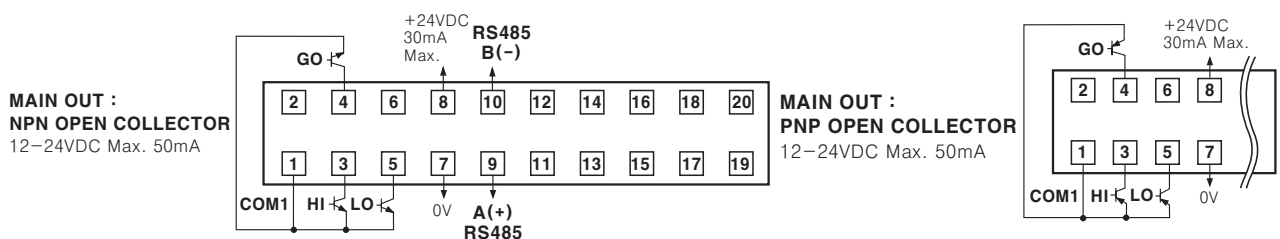

(A)
Counter

(B)
Timer

(C)
Temp.
controller

(D)
Power
controller

(E)
Panel
meter

(F)
Tacho/
Speed/
Pulse
meter

(G)
Display
unit

(H)
Sensor
controller

(I)
Switching
power
supply

(J)
Proximity
sensor

(K)
Photo
electric
sensor

(L)
Pressure
sensor

(M)
Rotary
encoder

(N)
Stepping
motor &
Driver &
Controller

(O)
Graphic
panel

(P)
Field
network
device

(Q)
Production
stoppage
models &
replacement

MT4Y/MT4W Series

Dimensions

(Unit:mm)

- MT4Y-□□-4N, 45, 46

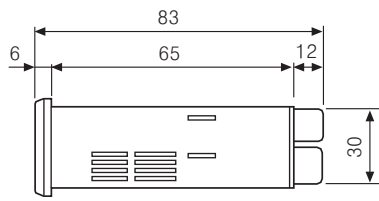
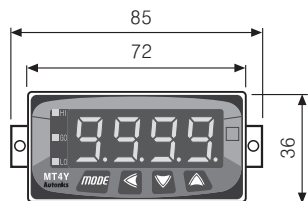

< MT4Y-□□-4N, 40~44, 46 >

- Panel cut-out

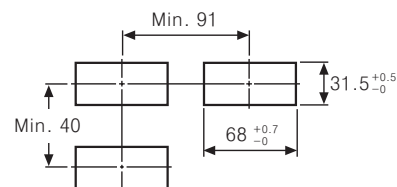

- MT4Y-□□-43, 44

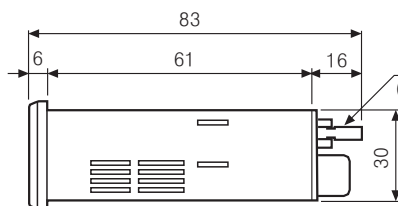

< MT4Y-□□-45 >

- MT4Y-□□-40, 41, 42



- MT4W-□□-4N (Indicator)

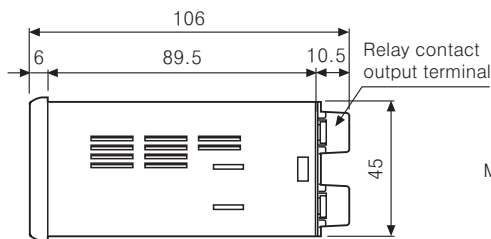
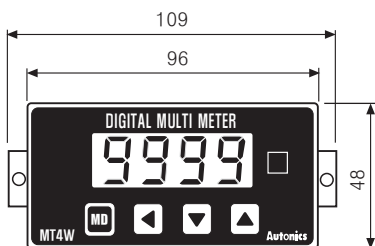

※ There is no Relay contact output terminal block in indication type.

< MT4W-□□-4N, MT4W-□□-40, 41 >

- Panel cut-out

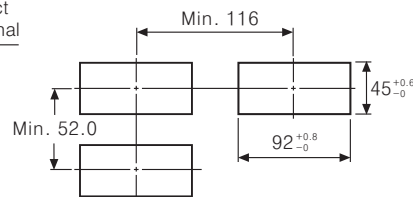

- MT4W-□□-40~49

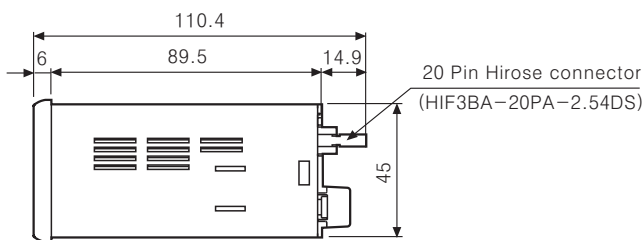
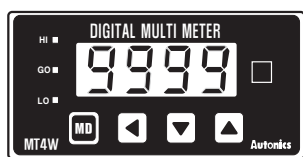

< MT4W-□□-42~49 >

Parameter setting

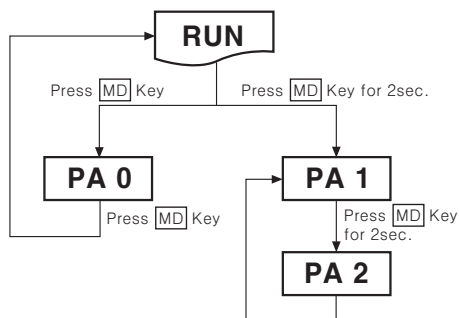

※ If [MD] key is pressed, it will advance to **PA-0** group.

It can be entered only when setting monitoring time of **Pek.t** mode in **PA-2** group or **Out.t** mode is not **OFF**.

※ If [MD] key is pressed for 2 sec, **PA-1** is displayed.

※ If [MD] key is pressed for 2 sec, **PA-2** is displayed after **PA-1**.

※ When releasing [MD] key at displaying **PA-1** or **PA-2**, then it will enter into Parameter.

※ If [MD] key is touched for 3 sec after advance to parameter, it will return to **RUN** mode.

Parameter group 1

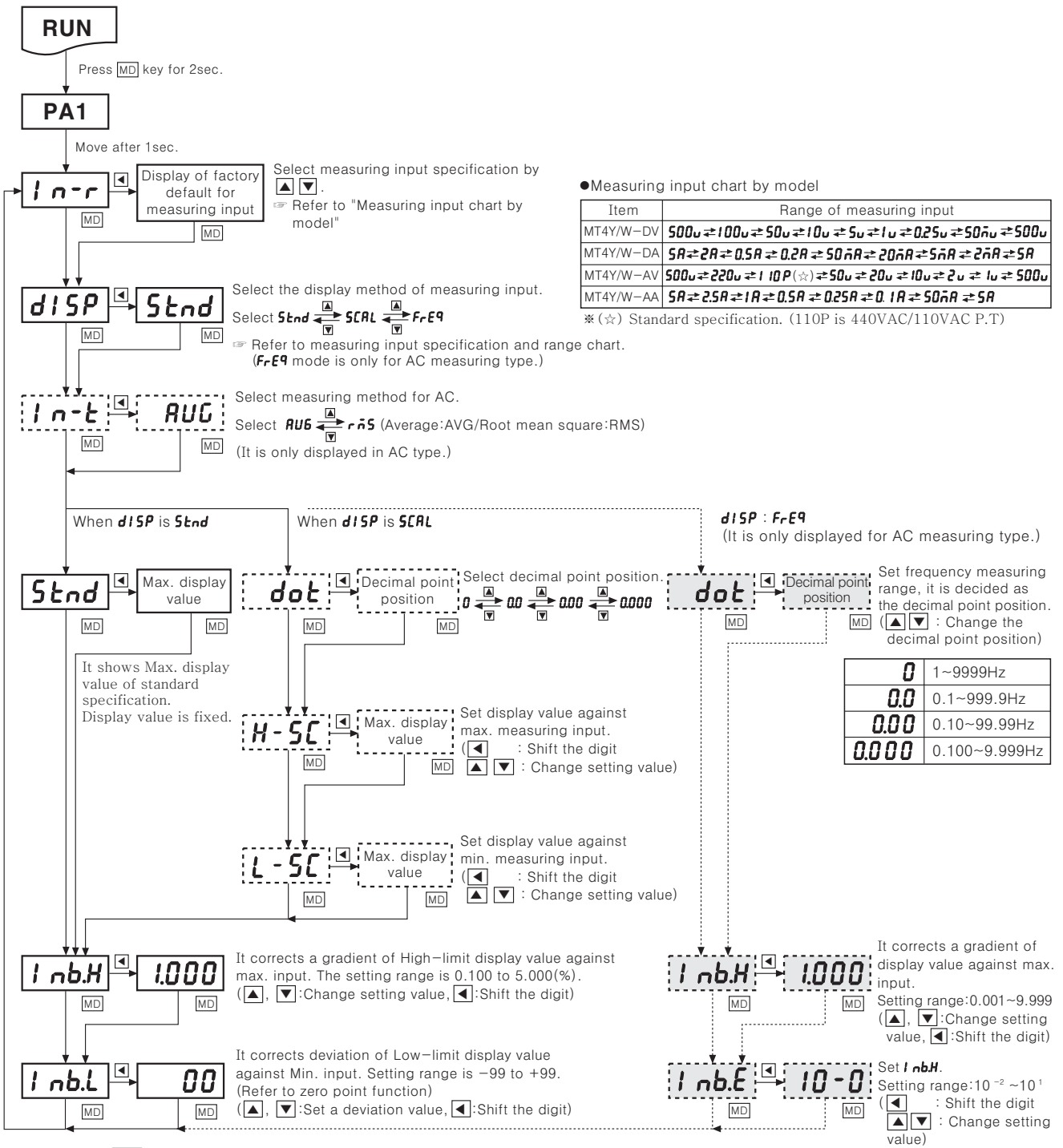

- ※ A blacked () display mode is added one.
- ※ After setting each mode, press MD Key for 2 sec. to return to RUN.
- ※ If any key is untouched for 60sec. after advance to Parameter, it will return to RUN.

Factory defaults

Mode	MT4Y/W-DV	MT4Y/W-DA	MT4Y/W-AV	MT4Y/W-AA	Mode	MT4Y/W-DV	MT4Y/W-DA	MT4Y/W-AV	MT4Y/W-AA
In-r	500u	5A	500u	5A	Inb.H	1.000	1.000	1.000	1.000
DISP	Stnd	Stnd	Stnd	Stnd	Inb.L	00	00	00	00
In-t	—	—	AUG	AUG	dot	—	—	00	00
Stnd	500.0	5.000	500.0	5.000	Inb.E	—	—	10-0	10-0

- (A) Counter
- (B) Timer
- (C) Temp. controller
- (D) Power controller
- (E) Panel meter
- (F) Tacho/Speed/Pulse meter
- (G) Display unit
- (H) Sensor controller
- (I) Switching power supply
- (J) Proximity sensor
- (K) Photo electric sensor
- (L) Pressure sensor
- (M) Rotary encoder
- (N) Stepping motor & Driver & Controller
- (O) Graphic panel
- (P) Field network device
- (Q) Production stoppage models & replacement

MT4Y/MT4W Series

Parameter group 2

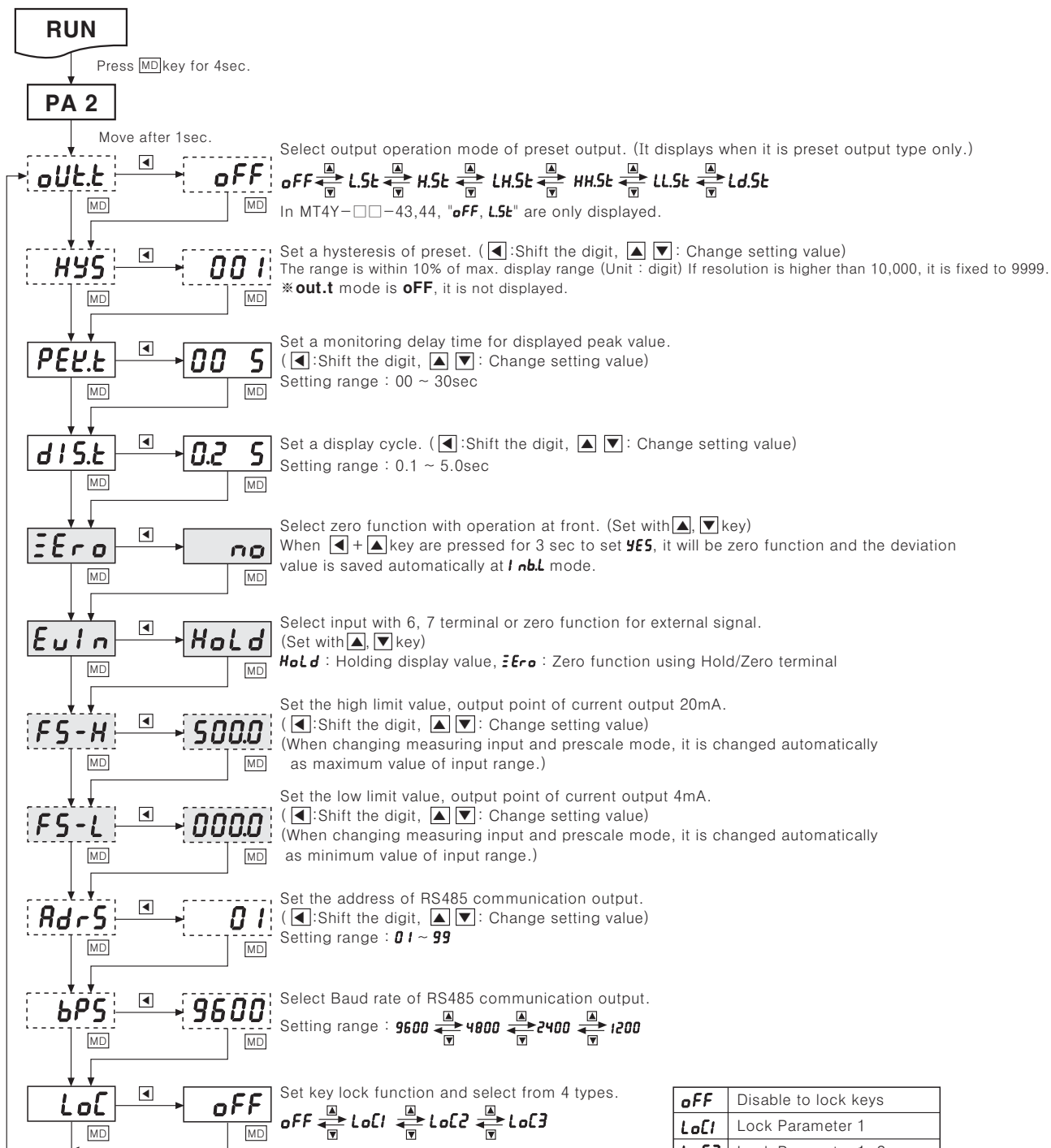

oFF	Disable to lock keys
LoC1	Lock Parameter 1
LoC2	Lock Parameter 1, 2
LoC3	Lock Parameter 0, 1 and 2

- * A blacked () display mode is added one.
- * The dotted mode is only displayed for output type.
- * After setting each mode, press **MD** Key for 2 sec. to return to **RUN** mode.
- * If any key is untouched for 60sec. after advance to PARAMETER, it will return to **RUN** mode.

Factory defaults

Mode	MT4Y/W-DV	MT4Y/W-DA	MT4Y/W-AV	MT4Y/W-AA	Mode	MT4Y/W-DV	MT4Y/W-DA	MT4Y/W-AV	MT4Y/W-AA
oUt.t	oFF	oFF	oFF	oFF	FS-H	500.0	500.0	500.0	500.0
HYS	00 1	00 1	00 1	00 1	FS-L	000.0	000.0	000.0	000.0
PEEL	00 5	00 5	00 5	00 5	AdRS	0 1	0 1	0 1	0 1
diSt	0.2 5	0.2 5	0.2 5	0.2 5	bPS	9600	9600	9600	9600
EErO	no	no	no	no	LoC	oFF	oFF	oFF	oFF
EvIn	Hold	Hold	Hold	Hold					

Parameter group 0

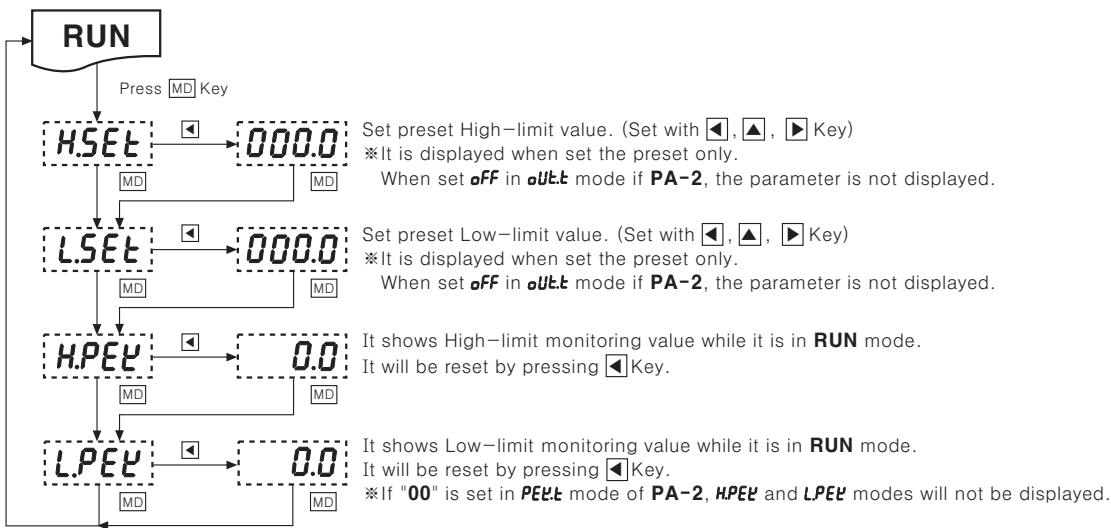

※ If any key is untouched for 60sec after advance to Parameter, it will return to **RUN** mode.

Factory default

Mode	MT4Y/W-DV	MT4Y/W-DA	MT4Y/W-AV	MT4Y/W-AA	Mode	MT4Y/W-DV	MT4Y/W-DA	MT4Y/W-AV	MT4Y/W-AA
HSEL	000.0	000.0	000.0	000.0	HPEL	0.0	0.000	0.0	0.000
LSEL	000.0	000.0	000.0	000.0	LPEL	0.0	0.000	0.0	0.000

Measuring input and range

※ A blacked (■) items are added input specifications.

Type	Measuring input and range	Input impedance	Standard specification[Stnd]	Prescale specification[SCAL]
			Display range[Fixed]	Display range[Variable]
DC Volt	0-500V [500V]	4.33MΩ	0.0-500.0	-1999~9999 -199.9~999.9 -19.99~99.99 -1.999~9.999 (The display range is changed according to the decimal point position.) ※ Please connect proper terminal its max. input voltage is within 30~ 100% of input terminal. When it is higher than input voltage, it may cause a breakdown of terminal and over display range and the accuracy is decreased when it is connected to the terminal under 30%.
	0-100V [100V]	4.33MΩ	0.0-100.0	
	0-50V [50V]	433.15kΩ	0.00-50.00	
	0-10V [10V]	433.15kΩ	0.00-10.00	
	0-5V [5V]	43.15kΩ	0.000-5.000	
	0-1V [1V]	43.15kΩ	0.000-1.000	
	0-250mV [0.25V]	2.15kΩ	0.0-250.0	
DC Ampere	0-50mA [50mA]	2.15kΩ	0.00-50.00	
	0-5A [5A]	0.01Ω	0.000-5.000	
	0-2A [2A]	0.01Ω	0.000-2.000	
	0-500mA [0.5A]	0.1Ω	0.0-500.0	
	0-200mA [0.2A]	0.1Ω	0.0-200.0	
	0-50mA [50mA]	1.0Ω	0.00-50.00	
	4-20mA [20mA]	1.0Ω	4.00-20.00	
AC Volt	0-5mA [5mA]	10.0Ω	0.000-5.000	
	0-2mA [2mA]	10.0Ω	0.000-2.000	
	0-500V [500V]	4.98MΩ	0.0-500.0	
	0-250V [250V]	4.98MΩ	0.0-250.0	
	0-110V [110V]	1.08MΩ	0.0-440.0	
	0-50V [50V]	1.08MΩ	0.00-50.00	
	0-20V [20V]	200kΩ	0.00-20.00	
AC Ampere	0-10V [10V]	200kΩ	0.00-10.00	
	0-2V [2V]	20kΩ	0.000-2.000	
	0-1V [1V]	20kΩ	0.000-1.000	
	0-5A [5A]	0.01Ω	0.000-5.000	
	0-2.5A [2.5A]	0.01Ω	0.000-2.500	
	0-1A [1A]	0.05Ω	0.000-1.000	
	0-500mA [0.5A]	0.1Ω	0.0-500.0	
AC Ampere	0-250mA [0.25A]	0.1Ω	0.0-250.0	
	0-100mA [0.1A]	0.5Ω	0.0-100.0	
	0-50mA [50mA]	0.5Ω	0.00-50.00	

- (A) Counter
- (B) Timer
- (C) Temp. controller
- (D) Power controller
- (E) Panel meter
- (F) Tacho/Speed/Pulse meter
- (G) Display unit
- (H) Sensor controller
- (I) Switching power supply
- (J) Proximity sensor
- (K) Photo electric sensor
- (L) Pressure sensor
- (M) Rotary encoder
- (N) Stepping motor & Driver & Controller
- (O) Graphic panel
- (P) Field network device
- (Q) Production stoppage models & replacement

MT4Y/MT4W Series

Functions

Measuring AC frequency function (PA1 : d15P mode)

It measures the frequency of input signal when it is AC input. The measuring range is 0.1~9999Hz, it is changed according to the decimal point position.

Please refer to the below table.

Decimal point position	0.000	0.00	0.0	0
Measurement range	0.100~9.999Hz	0.10~99.99Hz	0.1~999.9Hz	1~9999Hz

It is also available to adjust the high limit of gradient at **lnbH** and **lnbE** mode of **PA 1**.

To measure correctly, the input signal is over F.S 10% of measuring range should be supplied.

Zero adjustment function(Deviation correction function of low limit display value)

It sets the display value as a zero when min. input is supplied at measuring input terminal. It can be corrected an error of zero with 3 types as below.

The deviation value is corrected normally with external Hold/Zero terminal can be saved automatically **lnbL** mode of **PA 1** group.

Type	Input the deviation value	Front key	Input the external signal
Description	Input the deviation value in lnbL mode of PA 1	Input the minimum value at the measuring input terminal, press [H] , [Z] key together for 3 sec.	Short-circuit external No.6, 7 Hold/Zero terminal over min.50ms.

*Please refer to Low display correction of error correction function for inputting the correction value.

Current output(DC4~20mA) scale function (PA2 : F5-H / F5-L mode)

It outputs DC4~20mA within the setting range of **F5-H** and **F5-L** mode to transmit the of display value to the other. When it is over the setting value of **F5-H** of **PA 2**, 20mA is outputted and 4mA for it is under the setting value of **F5-L** mode. (The resolution is divided as 12000 and it depends on full scale range.)

*The min. setting interval between **F5-H** and **F5-L** is 10% F · S, it is fixed as 10% of the setting value when it is small.

*In case, the display value is under **F5-L**, 4mA is outputted and 20mA for it is over the setting value of **F5-H** mode.

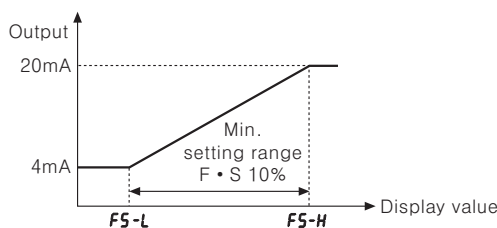

Initialization function

It initializes as the factory default status. If **[H]**, **[Z]**, **[A]** keys are pressed together for 2 sec in **RUN** mode, **lnbE** mode and the setting value(**no**) is displayed every 0.5 sec and it will be initialized as the factory default when press **[MD]** key after change **no** → **YES**.

Error display function

Display	Description
HHHH	Flashing when measuring input is exceeded the max. allowable input(110%)
LLLL	Flashing when measuring input is exceeded the minx. allowable input(-10%)
d-HH	Flashing when display input is exceeded H-SC setting value
d-LL	Flashing when display input is exceeded L-SC setting value
F-HH	Flashing when input frequency is exceeded the max. display value of measuring range
ouEr	Flashing when it exceeds zero range(±99).

*An error is cancelled automatically when it is in the measuring and display range.

*"LLLL" is displayed when the measuring input is 4~20mA.

*After flashing "ouEr" 2 times when it exceeds the zero range, it returns to RUN mode.

Prescale function(PA 1 : H-5C/L-5C mode)

This function is to display setting(-1999 to 9999) of particular High/Low-limit value in order to display High/Low-limit value of measuring input. If measuring inputs are a or b and particular values are A or B, it will display a=A, b=B as below graph.

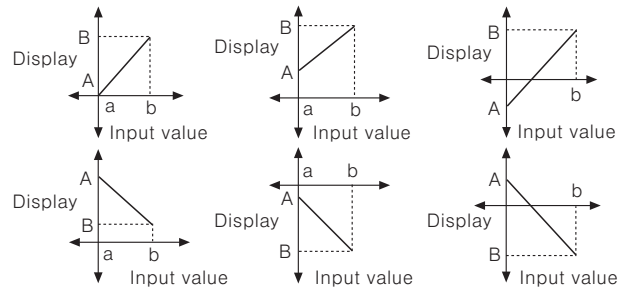

Gradient correction function(PA1:lnbH mode)

This function is to correct a gradient of prescale value and display value. (Fig.1) Display value Y can be used as α , β times against X input value by correction function [**lnbH**]. And also can be used as correction function of max. display value (**H-5C**). Adjustment range is 0.100 to 5.000 and multiply current gradient.

Ex) Input:DC200mV, Display:3.000 for MT4W-DV

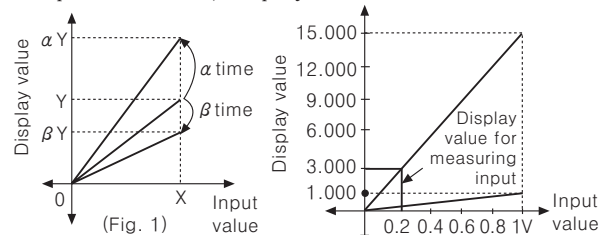

(Setting the gradient correction value)

- Select 0~1VDC for measuring input in Parameter1.
- Standard specification in input : 0~1VDC and 1.000 therefore it has to be 15.000 (**H-5C**) for 1VDC(input) in order to display 3.000 for DC200mV(input). But it is disable due to setting range is 9.999
- In this case, please check below chart.

Please set as **lnbH** × **H-5C** = 15.000

Setting	H-5C	L-5C	lnbH	Other
①	Disable	0.000	1.000	It will be the same display value.
②	7.500	0.000	2.000	
③	5.000	0.000	3.000	
④	3.750	0.000	4.000	
⑤	3.000	0.000	5.000	

◎Correction function(PA 1: *l nb.H / l nb.L* mode)

This function is for correcting display value error of measuring input.

l nb.H: 5.000 ~ 0.100 [Correct gradient(%) of High value]

l nb.L: -99 ~ +99 [Adjust deviation of Low value]

Ex)When measuring input range is 0~500VDC and a display value is 0.0~500.0.

●Correction of high display value

When the measuring input is 500V, the deviation correction value is $5000 \div 5005 = 0.999$ for high display value "500.5" and it is available to correct the gradient of high display value when set 0.999 at *l nb.H*. The reset part of the decimal point is not calculated.

●Correction of low display value

When the measuring input is 0V, the deviation of low display value can be cleared if "-12" is set at *l nb.L* when low display value is "001.2".

The reset part of the decimal point is not calculated.

◎Display cycle delay function(PA 2:*d i S.t* mode)

It is difficult to read as display value follows the measuring input value. Display when the measuring input value is fluctuating. In this case, it is able to make display value stable by delaying display cycle. Display cycle displaying time can be changed in *d i S.t* mode of Parameter 2 (Setting range:0.1~5.0sec). If *5.0* is selected, the display value is displayed every 5sec. averaging input value for 5sec.

◎Monitoring function for peak value of display (PA 0: *HPEL/LPEL* mode)

It is to observe Max./Min. value of display value by current display value and then display the data in *HPEL* mode and *LPEL* mode of parameter 0.

Set delay time(0~30sec.) in *PEL.t* mode of parameter 2 in order to prevent malfunction caused by initial over current or over voltage, when it monitor the peak value. Delay time is 0~30sec. and it will monitor the peak value after setting time. If \blacktriangleleft key is pressed at *HPEL* and *LPEL* mode of parameter 0, monitoring data will be initialized.

◎Preset output Mode(PA 2: *oUt.t* mode)

Mode	Output operation	Operation
		H: Hysteresis
<i>oFF</i>		No output
<i>LSt</i>		If it is equal or smaller than low setting value, LO output will be ON. If it is bigger than low setting value, GO output will be ON.
<i>HSt</i>		If it is equal or bigger than high setting value, HI output will be ON. If it is equal or smaller than high setting value, GO output will be ON.
<i>LHSt</i>		If it is equal or smaller than low setting value and equal or bigger than high setting value, the output will be ON. If it is bigger than Low setting value and smaller than high setting value, GO output will be ON.
<i>HHSt</i>		If it is equal or bigger than low set and equal or bigger than high set value, output will be ON. If it is smaller than low setting value and high setting value, GO output will be ON.
<i>LLSt</i>		If it is equal or smaller than low setting value, LO output will be ON. If it is equal or smaller than high setting value, HI output will be ON. If it is bigger than low setting value and High setting value, GO output will be ON.
<i>LdSt</i>		This operation is the same as L.St. But it doesn't operate at initial low set value, it will operate at next low set value. If this is higher than low set value, Go output will be ON.

*"H" means hysteresis and able to set 1 to 99 at "HYS" mode in parameter 2 among above comparison output chart.

*In MT4Y-□□-43, 44, *LSt*, *HSt*, *LdSt* modes are only available to use.

◎Sub output(Transmission function)

●RS485 communication output

It is able to set address(01~99)

It is able to transmit by selecting modulation speed (Transmitted number of signal per 1sec.) of serial transmission. (Selectable 1200, 2400, 4800, 9600bps)

●Low-speed serial output

It outputs current display value as Low-frequency (50Hz) type.

●Current output (DC4~20mA)

It outputs DC4~20mA against High/Low-limit scale. (Resolution:12000 division)

●BCD output

It outputs display value as BCD Code.

***Only one sub-output is selectable.**

(More than one sub-output is not allowed.)

◎Time chart of BCD output and Low speed serial output

●BCD output(Negative logic)

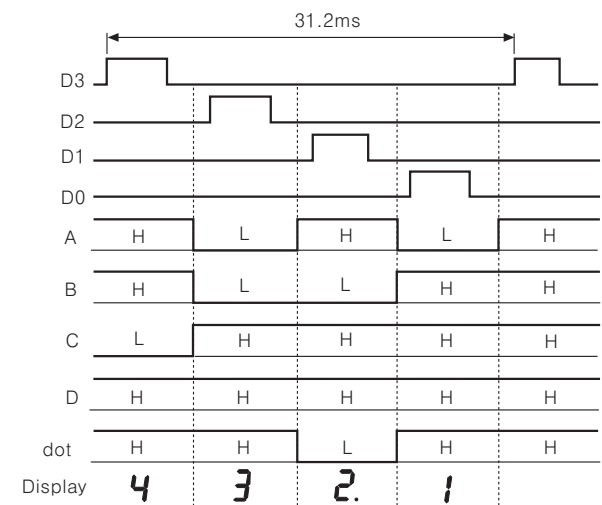
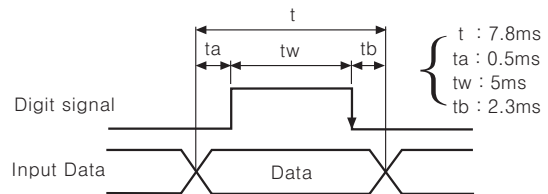

●Low speed serial output(Negative logic)

-Clock frequency:50Hz

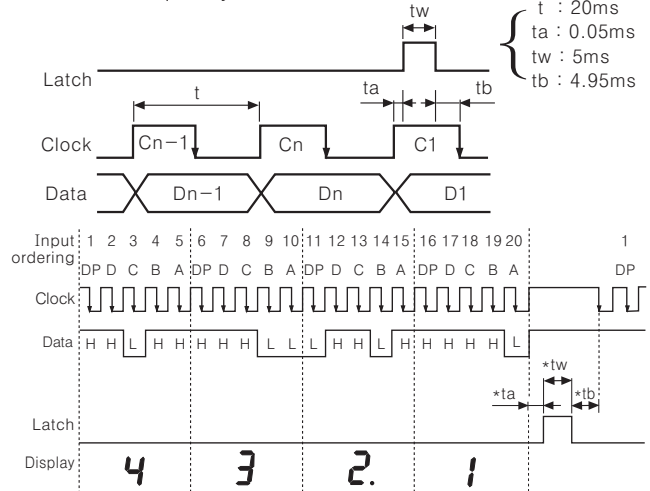

*When clock pulse changed from High to Low, Data will be read.

(A) Counter

(B) Timer

(C) Temp. controller

(D) Power controller

(E) Panel meter

(F) Tacho/ Speed/ Pulse meter

(G) Display unit

(H) Sensor controller

(I) Switching power supply

(J) Proximity sensor

(K) Photo electric sensor

(L) Pressure sensor

(M) Rotary encoder

(N) Stepping motor & Driver & Controller

(O) Graphic panel

(P) Field network device

(Q) Production stoppage models & replacement

MT4 Series

Communication output

The protocol is changed as MODBUS type.

Interface

Standard	EIA RS485
Number of connections	Max. 31 units.(It is available to set address 01~99.)
Communication method	2 wire half duplex
Synchronous method	Asynchronous type
Communication distance	Within max. 800m
Communication speed	1200, 2400, 4800, 9600bps
Start bit	1bit(Fixed)
Stop bit	1bit(Fixed)
Parity bit	none
Data bit	8bit(Fixed)
Protocol	MODBUS RTU

Application of system organization

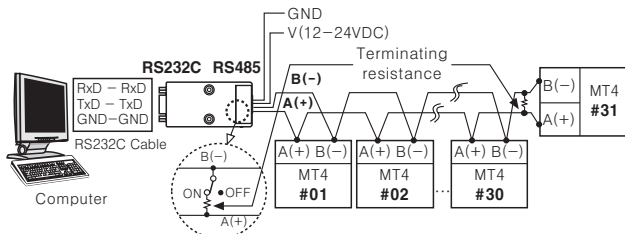

※Autonics SCM-38I is recommended to use for RS232C to RS485 converter.

※Please use proper twist pair line for RS485 communication cable.

Communication control ordering

1. The communication ordering of MT4 series is MODBUS RTU. (PI-MBUS-300-REV.J)
2. After 0.5sec being supplied the power into the high order system, it starts to communicate.
3. Initial communication will be started by the high order system. When a command comes out from the high order system, MT4 series will respond.

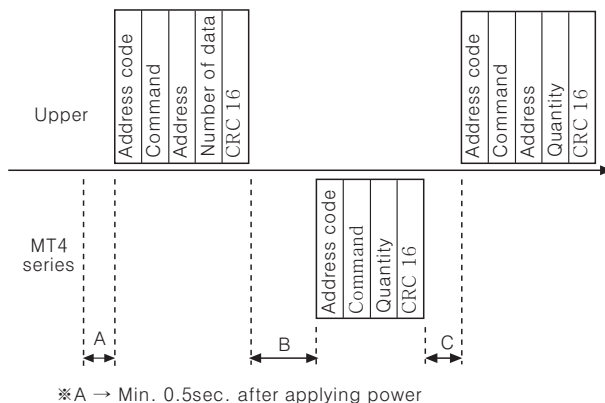

- B →
- 9600bps : Within 10.4ms
 - 4800bps : Within 20.8ms
 - 2400bps : Within 41.6ms
 - 1200bps : Within 83.3ms
- C →
- 9600bps : Within 4.2ms
 - 4800bps : Within 8.4ms
 - 2400bps : Within 16.7ms
 - 1200bps : Within 33.4ms

Communication command and block

The format of query and response

Query

Address code	Command	Start address	Number of data	CRC16
①	②	③	④	⑤
Calculation range of CRC16				

- ①Address code : This code is the high order system can discern MT4 series and able to set within range 01H-63H.
- ②Command : Read command for input register.
- ③Start address : The start address of input register to read (Start address), it is available to select 0000 to 0003 for start address.
- ④Number of data : The number of 16 bit data from start address(No. of Points)
- ⑤CRC16 : It is a Check Sum checking the whole frame and it is for more reliable transmit/receive to check the error between transmitter and receiver.

Response

Address code	Response Command	Number of data	PV	Decimal point position	Hi peak value	Low peak value	CRC16
①	②	③	④	⑤	⑥	⑦	⑧
Calculation range of CRC16							

- ①Unit number : Distinguish MT4 series and the number is available from 01H-63H.
- ②Response command : Response for a read command of input register. (Refer to Modbus Mapping Table)
- ③Amount of data : The number of 8 bit data on star code. (No. of Points)
- ④PV : It is 16 Bit data, measuring and display value of MT4 series. The decimal point data is not included in the transmitting PV.
- ⑤Decimal point position : It is the decimal point position is set in **dot** mode of Parameter 1.
- ⑥Hi Peak value : The max. display value of PV
- ⑦Lo Peak value : The min. display value of PV
- ⑧CRC16 : It is a Check Sum checking the whole block.

Application of communication command

In case, the display value of multi panel meter is 220.3V, the decimal point is 0.0, Hi Peak value is 220.4 and Lo Peak value is 0000.

Query

Address command	Command	Start address		Number of data		CRC16	
		High	Low	High	Low	Low	High
01	04	00	00	00	04	F1	C9

Response

Address command	Response command	Amount of data	Measured value		dot position		Hi Peak		Lo Peak		CRC16
			High	Low	High	Low	High	Low	High	Low	
01	04	08	08	9B	00	01	08	9C	00	00	CRC16

●Error processing(Slave → Master)

1. Non-supportable command

Unit number	Response command	Exception code	CRC16	
01	81	01	81	90

*Set a received highest bit and send it to response command and exception code 01.

2. A start code of queried data is inconsistent with the transmittable code

Unit number	Response command	Exception code	CRC16	
01	81	02	81	90

*Set a received highest bit and send it to response command and exception code 02.

3. The number of queried data is bigger than transmittable one

Unit number	Response command	Exception code	CRC16	
01	81	03	—	—

*Set a received highest bit and send it to response command and exception code 03.

◎Modbus Mapping Table

●Read Input Register

Start address	Com-mand	Transmission	Remark
30001 (0000)	04	Process value • Standard: Transmit up to -5%~110% of display range • Scale: Able to transmit from -1999 to 9999% of display range	Data transmittance for measuring error • Standard : Transmit "9999" if "HHHH" is displayed. Transmit "-1999" if "LLLL" is displayed. • Scale : Transmit the setting value of H-SC and L-SC . Transmit "9999" if "d-HH" is displayed. Transmit "-1999" if "d-LL" is displayed
30002 (0001)	04	Dot setting value	Transmit the position setting value of decimal point of PA-1 dot mode. • Standard: 0.00 0 → 0003H, 0.00 → 0002H, 0.0 → 0001H, 0 → 0000H, • Scale: 0.000 → 0103H, 0.00 → 0102H, 0.0 → 0101H, 0 → 0100H,
30003 (0002)	04	High Peak value	Transmit the max. display value of measuring display value
30004 (0003)	04	Low Peak value	Transmit the min. display value of measuring display value

●Read Coil Status

Start address	Com-mand	Transmission	Remark
00001 (0000)	01	Output status • 01h:Lo output • 02h:Go output • 04h:Hi output • 05h:Lo/Hi output	Transmit "1" if the output is ON and "0" for OFF.

◎Setting of communication speed

It is available to set the communication speed at **bps** mode of **PA 2**. The factory default is **9600**bps.

◎Setting of communication address (Setting range: 01~99)

It is enable to set the communication speed at **AdrS** mode of **PA 2**. The factory default is **01**.

It is enable to set the communication address up to 99 but only 31 units can be connected to higher system.

◎CRC16 Table

●High order byte Table

	0	1	2	3	4	5	6	7	8	9	A	B	C	D	E	F
0	0x00	0xC1	0x81	0x40	0x01	0xC0	0x80	0x41	0x01	0xC0	0x80	0x41	0x00	0xC1	0x81	0x40
1	0x01	0xC0	0x80	0x41	0x00	0xC1	0x81	0x40	0x00	0xC1	0x81	0x40	0x01	0xC0	0x80	0x41
2	0x01	0xC0	0x80	0x41	0x00	0xC1	0x81	0x40	0x00	0xC1	0x81	0x40	0x01	0xC0	0x80	0x41
3	0x00	0xC1	0x81	0x40	0x01	0xC0	0x80	0x41	0x01	0xC0	0x80	0x41	0x00	0xC1	0x81	0x40
4	0x01	0xC0	0x80	0x41	0x00	0xC1	0x81	0x40	0x00	0xC1	0x81	0x40	0x01	0xC0	0x80	0x41
5	0x00	0xC1	0x81	0x40	0x01	0xC0	0x80	0x41	0x01	0xC0	0x80	0x41	0x00	0xC1	0x81	0x40
6	0x00	0xC1	0x81	0x40	0x01	0xC0	0x80	0x41	0x01	0xC0	0x80	0x41	0x00	0xC1	0x81	0x40
7	0x01	0xC0	0x80	0x41	0x00	0xC1	0x81	0x40	0x00	0xC1	0x81	0x40	0x01	0xC0	0x80	0x41
8	0x01	0xC0	0x80	0x41	0x00	0xC1	0x81	0x40	0x00	0xC1	0x81	0x40	0x01	0xC0	0x80	0x41
9	0x00	0xC1	0x81	0x40	0x01	0xC0	0x80	0x41	0x01	0xC0	0x80	0x41	0x00	0xC1	0x81	0x40
A	0x00	0xC1	0x81	0x40	0x01	0xC0	0x80	0x41	0x01	0xC0	0x80	0x41	0x00	0xC1	0x81	0x40
B	0x01	0xC0	0x80	0x41	0x00	0xC1	0x81	0x40	0x00	0xC1	0x81	0x40	0x01	0xC0	0x80	0x41
C	0x00	0xC1	0x81	0x40	0x01	0xC0	0x80	0x41	0x01	0xC0	0x80	0x41	0x00	0xC1	0x81	0x40
D	0x01	0xC0	0x80	0x41	0x00	0xC1	0x81	0x40	0x00	0xC1	0x81	0x40	0x01	0xC0	0x80	0x41
E	0x01	0xC0	0x80	0x41	0x00	0xC1	0x81	0x40	0x00	0xC1	0x81	0x40	0x01	0xC0	0x80	0x41
F	0x00	0xC1	0x81	0x40	0x01	0xC0	0x80	0x41	0x01	0xC0	0x80	0x41	0x00	0xC1	0x81	0x40

●Low order byte Table

	0	1	2	3	4	5	6	7	8	9	A	B	C	D	E	F
0	0x00	0xC0	0xC1	0x01	0xC3	0x03	0x02	0xC2	0xC6	0x06	0x07	0xC7	0x05	0xC5	0xC4	0x04
1	0x0C	0x0C	0x0D	0xCD	0x0F	0xCF	0xCE	0x0E	0x0A	0xCA	0xCB	0x0B	0xC9	0x09	0x08	0xC8
2	0xD8	0x18	0x19	0xD9	0x1B	0xDB	0xDA	0x1A	0x1E	0xDE	0xDF	0x1F	0xDD	0x1D	0x1C	0xDC
3	0x14	0xD4	0xD5	0x15	0xD7	0x17	0x16	0xD6	0xD2	0x12	0x13	0xD3	0x11	0xD1	0xD0	0x10
4	0xF0	0x30	0x31	0xF1	0x33	0xF3	0xF2	0x32	0x36	0xF6	0xF7	0x37	0xF5	0x35	0x34	0xF4
5	0x3C	0xFC	0xFD	0x3D	0xFF	0x3F	0x3E	0xFE	0xFA	0x3A	0x3B	0xFB	0x39	0xF9	0xF8	0x38
6	0x28	0xE8	0xE9	0x29	0xEB	0x2B	0x2A	0xEA	0xEE	0x2E	0x2F	0xEF	0x2D	0xED	0xEC	0x2C
7	0xE4	0x24	0x25	0xE5	0x27	0xE7	0xE6	0x26	0x22	0xE2	0xE3	0x23	0xE1	0x21	0x20	0xE0
8	0xA0	0x60	0x61	0xA1	0x63	0xA3	0xA2	0x62	0x66	0xA6	0xA7	0x67	0xA5	0x65	0x64	0xA4
9	0x6C	0xAC	0xAD	0x6D	0xAF	0x6F	0x6E	0xAE	0xAA	0x6A	0x6B	0xAB	0x69	0xA9	0xA8	0x68
A	0x78	0xB8	0xB9	0x79	0xBB	0x7B	0x7A	0xBA	0xBE	0x7E	0x7F	0xBF	0x7D	0xBD	0xBC	0x7C
B	0xB4	0x74	0x75	0xB5	0x77	0xB7	0xB6	0x76	0x72	0xB2	0xB3	0x73	0xB1	0x71	0x70	0xB0
C	0x50	0x90	0x91	0x51	0x93	0x53	0x52	0x92	0x96	0x56	0x57	0x97	0x55	0x95	0x94	0x54
D	0x9C	0x5C	0x5D	0x9D	0x5F	0x9F	0x9E	0x5E	0x5A	0x9A	0x9B	0x5B	0x99	0x59	0x58	0x98
E	0x88	0x48	0x49	0x89	0x4B	0x8B	0x8A	0x4A	0x4E	0x8E	0x8F	0x4F	0x8D	0x4D	0x4C	0x8C
F	0x44	0x84	0x85	0x45	0x87	0x47	0x46	0x86	0x82	0x42	0x43	0x83	0x41	0x81	0x80	0x40

■Caution for using

- It is disable to modify Parameter(Baud rate, Address etc)related to communication of MT4 series on line with upper systems such as PC, PLC etc. (Error will occur)
- First make communication Parameter of MT4 series and upper system one.
- It is not allow to set overlapping communication number at the same communication line. (Error will occur)
- Please use Twist pair wire for RS485 communication.
- The total length of communication is 800m and max. 31 units can be connected.
- When connecting communication cable between MT4 series and upper systems, the vertical resistance(100 to 120Ω) must be installed at between both communication lines.
- The setting item of communication parameter is as below.
 - Start bit : 1bit(Fixed)
 - Stop bit : 1bit(Fixed)
 - Parity bit : None(Fixed)
 - Data bit : 8bit(Fixed)
 - Baud rate : 9600, 4800, 2400(Setting)
 - Address : 01~99(Setting)

(A) Counter

(B) Timer

(C) Temp. controller

(D) Power controller

(E) Panel meter

(F) Tacho/Speed/Pulse meter

(G) Display unit

(H) Sensor controller

(I) Switching power supply

(J) Proximity sensor

(K) Photo electric sensor

(L) Pressure sensor

(M) Rotary encoder

(N) Stepping motor & Driver & Controller

(O) Graphic panel

(P) Field network device

(Q) Production stoppage models & replacement

X-ON Electronics

Largest Supplier of Electrical and Electronic Components

Click to view similar products for [Autonics](#) manufacturer:

Other Similar products are found below :

[MT4W-DV-4N](#) [CR30-15AO](#) [E40S6-2500-6-L-5](#) [LP-S070-T9D6-C5T](#) [PRFT30-10DO-V](#) [PRFWT12-2DO-IV](#) [PRFWT30-10DO-IV](#) [TC4W-24R](#) [TK4H-14CC](#) [TX4S-B4C](#) [TX4S-B4S](#) [CR30-15AC](#) [PRD12-8DN](#) [TMHA-42AE](#) [TMHE-82RE](#) [CX6M-1P2](#) [PRFAT12-2DO-V](#) [PRFAWT12-2DO-IV](#) [PT4-S3DP5](#) [PT8-S3DP5](#) [SRH2-4440](#) [SRH3-4430](#) [SRHL1-4220](#) [TF33-31H-R](#) [E50S8-360-3-T-24](#) [BTF30-DDTL-P](#) [PR08-1.5DP2](#) [PRL30-10DP](#) [AT8PSN-6 100/120VAC](#) [CT6S-2P4](#) [BJ15M-TDT-P](#) [E40H12-1000-6-L-5](#) [PRCM12-2DN](#) [PRDCM12-4DN](#) [PRDCM18-14DN](#) [PRDCM18-7DN](#) [PRDCM30-25DN](#) [PRDCML12-8DN](#) [PRDCML18-7DP](#) [PRDCML30-25DN](#) [SR1-4425](#) [SR3-2450](#) [TK4H-14SC](#) [TK4H-14SR](#) [TK4M-14RN](#) [TK4N-14RC](#) [TX4S-A4S](#) [PR08-1.5DP](#) [PR18-5AO](#) [SR3-1440R](#)