

## Base strip - MSTBA 2,5/ 5-G-5,08 - 1757271

Please be informed that the data shown in this PDF Document is generated from our Online Catalog. Please find the complete data in the user's documentation. Our General Terms of Use for Downloads are valid (<http://phoenixcontact.com/download>)

Header, Nominal current: 12 A, Rated voltage (III/2): 320 V, Number of positions: 5, Pitch: 5.08 mm, Color: green, Contact surface: Tin, Mounting: Soldering



The figure shows a 10-position version of the product

### Why buy this product

- Other pin lengths available on request
- Plug-in direction parallel to the conductor axis
- W type with stand-off
- Standard pin strip for 320 V (III/2)



### Key Commercial Data

Packing unit	250 pc
GTIN	 4 017918 029807
Weight per Piece (excluding packing)	1.99 g
Custom tariff number	85366990
Country of origin	Germany

### Technical data

#### Dimensions

Length	12 mm
Pitch	5.08 mm
Dimension a	20.32 mm
Width	27.32 mm
Constructional height	8.6 mm
Height	12.1 mm
Length of the solder pin	3.5 mm
Pin dimensions	1 x 1 mm
Hole diameter	1.4 mm

#### General

# Base strip - MSTBA 2,5/ 5-G-5,08 - 1757271

## Technical data

### General

Range of articles	MSTBA 2,5/...-G
Insulating material group	I
Rated surge voltage (III/3)	4 kV
Rated surge voltage (III/2)	4 kV
Rated surge voltage (II/2)	4 kV
Rated voltage (III/3)	250 V
Rated voltage (III/2)	320 V
Rated voltage (II/2)	400 V
Connection in acc. with standard	EN-VDE
Nominal current $I_N$	12 A
Maximum load current	12 A
Insulating material	PA
Flammability rating according to UL 94	V0
Color	green
Number of positions	5

### Standards and Regulations

Connection in acc. with standard	EN-VDE
	CSA
Flammability rating according to UL 94	V0

## Classifications

### eCl@ss

eCl@ss 4.0	272607xx
eCl@ss 4.1	27260701
eCl@ss 5.0	27260701
eCl@ss 5.1	27260701
eCl@ss 6.0	27260704
eCl@ss 7.0	27440402
eCl@ss 8.0	27440402

### ETIM

ETIM 3.0	EC001121
ETIM 4.0	EC002637
ETIM 5.0	EC002637

### UNSPSC

UNSPSC 6.01	30211810
UNSPSC 7.0901	39121409
UNSPSC 11	39121409
UNSPSC 12.01	39121409

# Base strip - MSTBA 2,5/ 5-G-5,08 - 1757271

## Classifications

### UNSPSC

UNSPSC 13.2	39121409
-------------	----------

## Approvals

### Approvals

#### Approvals

CSA / VDE Gutachten mit Fertigungsüberwachung / IECCEB Scheme / CCA / EAC / cULus Recognized

#### Ex Approvals

#### Approvals submitted

## Approval details

CSA 		
	B	D
Nominal current IN	15 A	10 A
Nominal voltage UN	300 V	300 V

VDE Gutachten mit Fertigungsüberwachung 	
Nominal current IN	12 A
Nominal voltage UN	250 V

IECCEB Scheme 	
Nominal current IN	12 A
Nominal voltage UN	250 V

CCA
-----

EAC
-----

## Base strip - MSTBA 2,5/ 5-G-5,08 - 1757271

### Approvals

cULus Recognized		
	B	D
Nominal current I <sub>N</sub>	15 A	10 A
Nominal voltage U <sub>N</sub>	300 V	300 V

### Accessories

#### Accessories

#### Coding element

Coding star - CR-MSTB - 1734401



Coding section, inserted into the recess in the header or the inverted plug, red insulating material

#### Filler plug

Accessories - MSTB-BL - 1755477



Keying cap, for forming sections, plugs onto header pin, green insulating material

#### Labeled terminal marker

Marker card - SK 5,08/3,8:FORTL.ZAHLEN - 0804293



Marker card, Card, white, labeled, Horizontal: Consecutive numbers 1 - 10, 11 - 20, etc. up to 91 - (99)100, Mounting type: Adhesive, for terminal block width: 5.08 mm, Lettering field: 5.08 x 3.8 mm

#### Terminal marking

Marker card - SK 5,08/3,8:UNBEDRUCKT - 0805412



Marker card, Card, white, unlabeled, can be labeled with: Marker pen, Mounting type: Adhesive, for terminal block width: 5.08 mm, Lettering field: 5.08 x 3.8 mm

## Base strip - MSTBA 2,5/ 5-G-5,08 - 1757271

### Accessories

---

#### Additional products

Printed-circuit board connector - TVMSTB 2,5/ 5-ST-5,08 - 1719037



Plug component, Nominal current: 12 A, Rated voltage (III/2): 400 V, Number of positions: 5, Pitch: 5.08 mm, Connection method: Screw connection, Color: green, Contact surface: Tin

---

Printed-circuit board connector - FKCN 2,5/ 5-ST-5,08 - 1754597



Plug component, Nominal current: 12 A, Rated voltage (III/2): 320 V, Number of positions: 5, Pitch: 5.08 mm, Connection method: Push-in spring connection, Color: green, Contact surface: Tin

---

Printed-circuit board connector - MSTB 2,5/ 5-ST-5,08 - 1757048



Plug component, Nominal current: 12 A, Rated voltage (III/2): 320 V, Number of positions: 5, Pitch: 5.08 mm, Connection method: Screw connection, Color: green, Contact surface: Tin

---

Printed-circuit board connector - MSTBP 2,5/ 5-ST-5,08 - 1769049



Plug component, Nominal current: 12 A, Rated voltage (III/2): 320 V, Number of positions: 5, Pitch: 5.08 mm, Connection method: Screw connection, Color: green, Contact surface: Tin

---

Printed-circuit board connector - MSTB 2,5/ 5-STZ-5,08 - 1776142



Plug component, Nominal current: 12 A, Rated voltage (III/2): 320 V, Number of positions: 5, Pitch: 5.08 mm, Connection method: Screw connection, Color: green, Contact surface: Tin

---

## Base strip - MSTBA 2,5/ 5-G-5,08 - 1757271

### Accessories

Printed-circuit board connector - FRONT-MSTB 2,5/ 5-ST-5,08 - 1777316

Plug component, Nominal current: 12 A, Rated voltage (III/2): 320 V, Number of positions: 5, Pitch: 5.08 mm, Connection method: Screw connection, Color: green, Contact surface: Tin



Printed-circuit board connector - MSTBT 2,5/ 5-ST-5,08 - 1781014

Plug component, Nominal current: 12 A, Rated voltage (III/2): 320 V, Number of positions: 5, Pitch: 5.08 mm, Connection method: Screw connection, Color: green, Contact surface: Tin



Printed-circuit board connector - MVSTBR 2,5/ 5-ST-5,08 - 1792278

Plug component, Nominal current: 12 A, Rated voltage (III/2): 320 V, Number of positions: 5, Pitch: 5.08 mm, Connection method: Screw connection, Color: green, Contact surface: Tin



Printed-circuit board connector - MVSTBW 2,5/ 5-ST-5,08 - 1792786

Plug component, Nominal current: 12 A, Rated voltage (III/2): 320 V, Number of positions: 5, Pitch: 5.08 mm, Connection method: Screw connection, Color: green, Contact surface: Tin



Printed-circuit board connector - MSTBC 2,5/ 5-ST-5,08 - 1808845

Plug component, Nominal current: 12 A, Rated voltage (III/2): 320 V, Number of positions: 5, Pitch: 5.08 mm, Connection method: Crimp connection, Color: green, Corresponding female crimp contacts with current [A] and conductor cross section range [mm<sup>2</sup>] data: 10A/MSTBC-MT 0,5-1,0 (3190564); 10A/MSTBC-MT 0,5-1,0 BA (3190645); 12A/MSTBC-MT 1,5-2,5 (3190551); 12A/MSTBC-MT 1,5-2,5 BA (3190658). BA = Bandkontakte



## Base strip - MSTBA 2,5/ 5-G-5,08 - 1757271

### Accessories

#### Printed-circuit board connector - MSTBC 2,5/ 5-STZ-5,08 - 1809530



Plug component, Nominal current: 12 A, Rated voltage (III/2): 320 V, Number of positions: 5, Pitch: 5.08 mm, Connection method: Crimp connection, Color: green, Corresponding female crimp contacts with current [A] and conductor cross section range [mm<sup>2</sup>] data: 10A/MSTBC-MT 0,5-1,0 (3190564); 10A/MSTBC-MT 0,5-1,0 BA (3190645); 12A/MSTBC-MT 1,5-2,5 (3190551); 12A/MSTBC-MT 1,5-2,5 BA (3190658). BA = Bandkontakte

#### Printed-circuit board connector - MSTBU 2,5/ 5-STD-5,08 - 1824159



Plug component, Nominal current: 12 A, Rated voltage (III/2): 320 V, Number of positions: 5, Pitch: 5.08 mm, Connection method: Screw connection, Color: green, Contact surface: Tin, Mounting: Direct mounting

#### Printed-circuit board connector - MSTBU 2,5/ 5-ST-5,08-FL - 1824382



Plug component, Nominal current: 12 A, Rated voltage (III/2): 320 V, Number of positions: 5, Pitch: 5.08 mm, Connection method: Screw connection, Color: green, Contact surface: Tin, Mounting: Direct mounting

#### Printed-circuit board connector - SMSTB 2,5/ 5-ST-5,08 - 1826319



Plug component, Nominal current: 12 A, Rated voltage (III/2): 320 V, Number of positions: 5, Pitch: 5.08 mm, Connection method: Screw connection, Color: green, Contact surface: Tin

#### Printed-circuit board connector - MSTBVK 2,5/ 5-ST-5,08 - 1831346



Plug component, Nominal current: 12 A, Rated voltage (III/2): 320 V, Number of positions: 5, Pitch: 5.08 mm, Connection method: Screw connection, Color: green, Contact surface: Tin, Mounting: DIN rail

## Base strip - MSTBA 2,5/ 5-G-5,08 - 1757271

### Accessories

Printed-circuit board connector - UMSTBVK 2,5/ 5-ST-5,08 - 1833849



Plug component, Nominal current: 12 A, Rated voltage (III/2): 320 V, Number of positions: 5, Pitch: 5.08 mm, Connection method: Screw connection, Color: green, Contact surface: Tin, Mounting: DIN rail

Printed-circuit board connector - TMSTBP 2,5/ 5-ST-5,08 - 1853049



Plug component, Nominal current: 12 A, Rated voltage (III/2): 320 V, Number of positions: 5, Pitch: 5.08 mm, Connection method: Screw connection, Color: green, Contact surface: Tin, The plug allows conductors to be looped through from module to module.

Printed-circuit board connector - FKC 2,5/ 5-ST-5,08 - 1873087



Plug component, Nominal current: 12 A, Rated voltage (III/2): 320 V, Number of positions: 5, Pitch: 5.08 mm, Connection method: Push-in spring connection, Color: green, Contact surface: Tin

Printed-circuit board connector - FKCVW 2,5/ 5-ST-5,08 - 1873689



Plug component, Nominal current: 12 A, Rated voltage (III/2): 320 V, Number of positions: 5, Pitch: 5.08 mm, Connection method: Push-in spring connection, Color: green, Contact surface: Tin

Printed-circuit board connector - FKCVR 2,5/ 5-ST-5,08 - 1873980



Plug component, Nominal current: 12 A, Rated voltage (III/2): 320 V, Number of positions: 5, Pitch: 5.08 mm, Connection method: Push-in spring connection, Color: green, Contact surface: Tin



# Base strip - MSTBA 2,5/ 5-G-5,08 - 1757271

## Accessories

Printed-circuit board connector - QC 1/ 5-ST-5,08 - 1883284

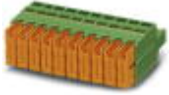

Plug component, Nominal current: 10 A, Rated voltage (III/2): 630 V, Number of positions: 5, Pitch: 5.08 mm, Connection method: Insulation displacement connection QUICKON, Color: green, Contact surface: Tin

Printed-circuit board connector - FKCT 2,5/ 5-ST-5,08 - 1902149



Plug component, Nominal current: 12 A, Rated voltage (III/2): 320 V, Number of positions: 5, Pitch: 5.08 mm, Connection method: Push-in spring connection, Color: green, Contact surface: Tin

Printed-circuit board connector - TFKC 2,5/ 5-ST-5,08 - 1962639



Plug component, Nominal current: 12 A, Rated voltage (III/2): 320 V, Number of positions: 5, Pitch: 5.08 mm, Connection method: Push-in spring connection, Color: green, Contact surface: Tin

Printed-circuit board connector - FKCS 2,5/ 5-ST-5,08 - 1975105



Plug component, Nominal current: 12 A, Rated voltage (III/2): 320 V, Number of positions: 5, Pitch: 5.08 mm, Connection method: Push-in spring connection, Color: green, Contact surface: Tin

## Drawings

Drilling diagram

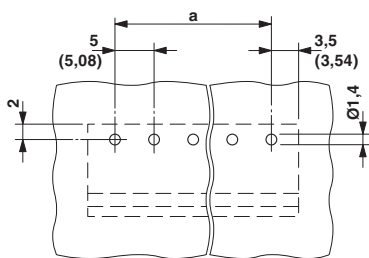

Diagram

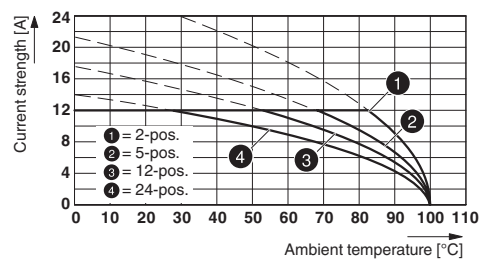

Type: ICV 2,5/..-G-5,08 with MSTBA 2,5/..-G-5,08

# Base strip - MSTBA 2,5/ 5-G-5,08 - 1757271

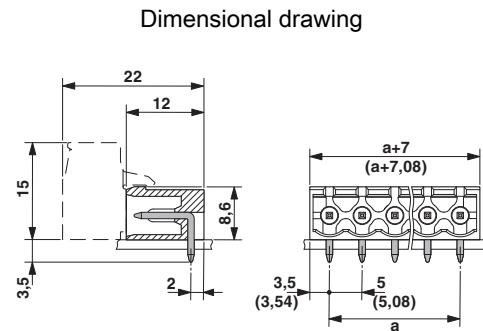
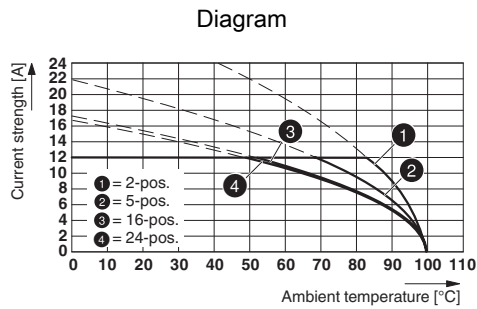

Type: IC 2,5/...-G-5,08 with MSTBA 2,5/...-G-5,08

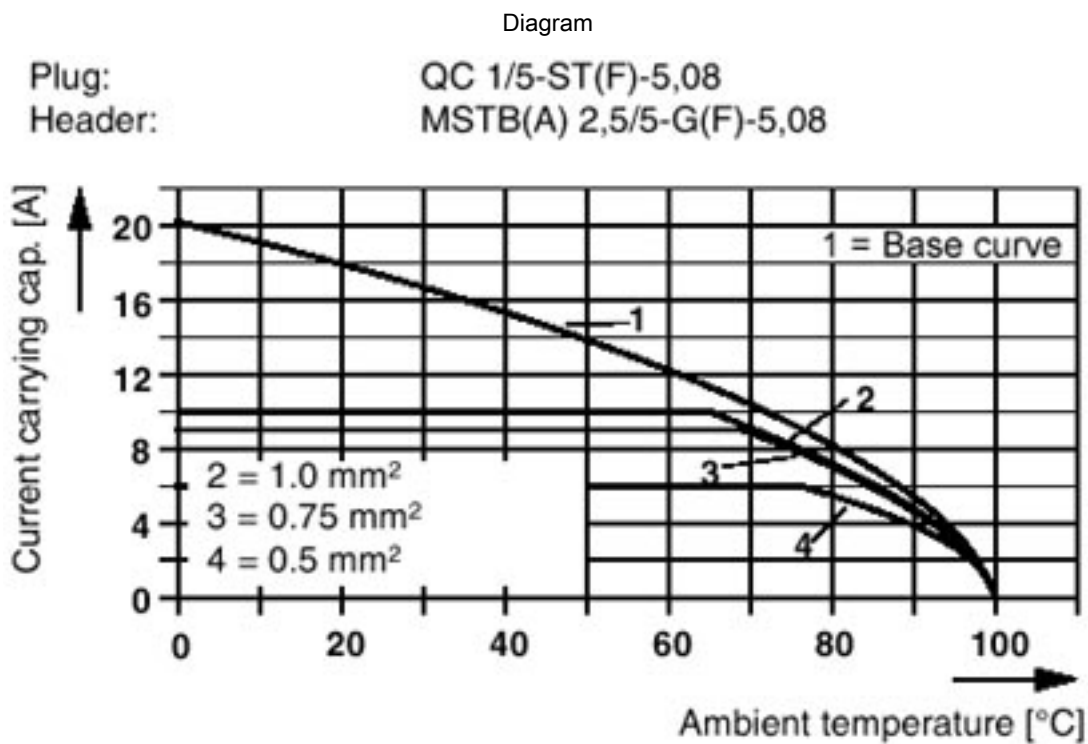

## Base strip - MSTBA 2,5/ 5-G-5,08 - 1757271

Diagram

Plug: MSTBT 2,5/5-ST(F)-(-5,08)  
 Header: MSTB(A) 2,5/5-G(F)-(-5,08)

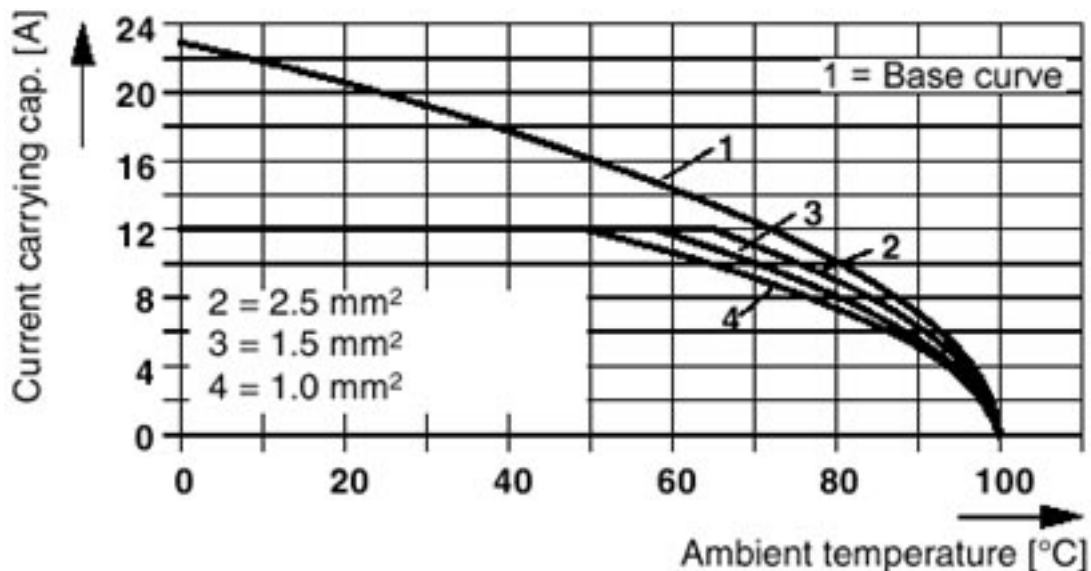

Diagram

Plug: SMSTB 2,5/5-ST(F)-(-5,08)  
 Header: MSTB(A) 2,5/5-G(F)-(-5,08)

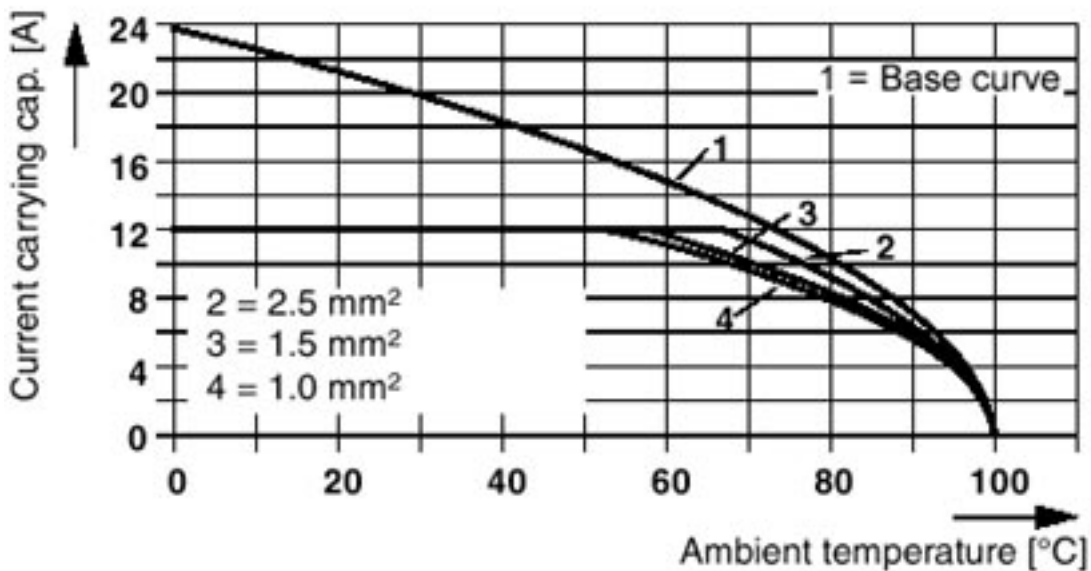

# Base strip - MSTBA 2,5/ 5-G-5,08 - 1757271

Diagram

Plug: MVSTBR(W) 2,5/5-ST(F)-(-5,08)  
Header: MSTB(A) 2,5/5-G(F)-(-5,08)

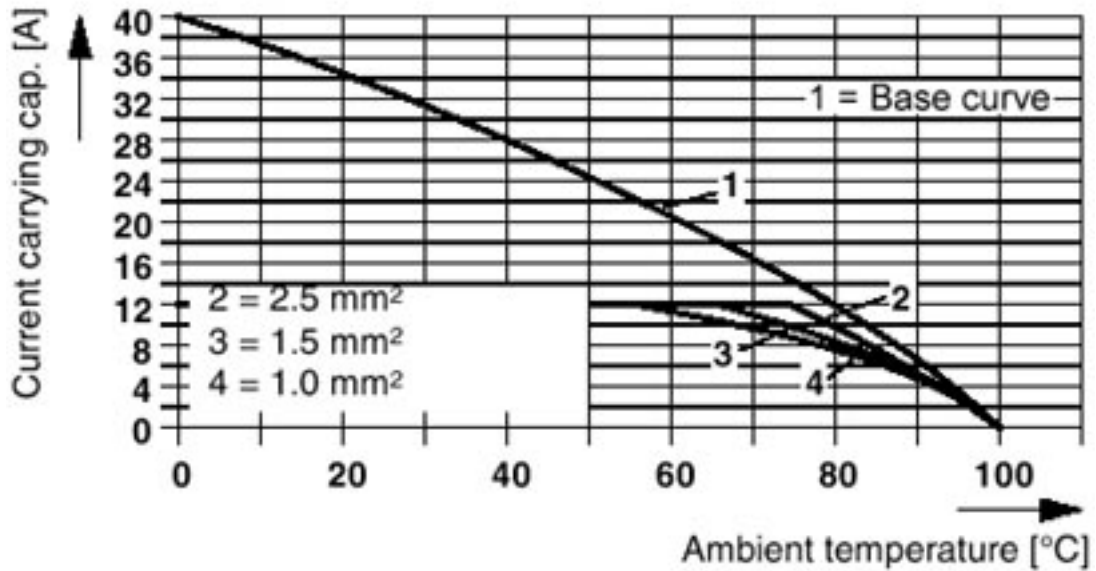

Diagram

Plug: FRONT-MSTB 2,5/5-ST(F)-(-5,08)  
Header: MSTB(A) 2,5/5-G(F)-(-5,08)

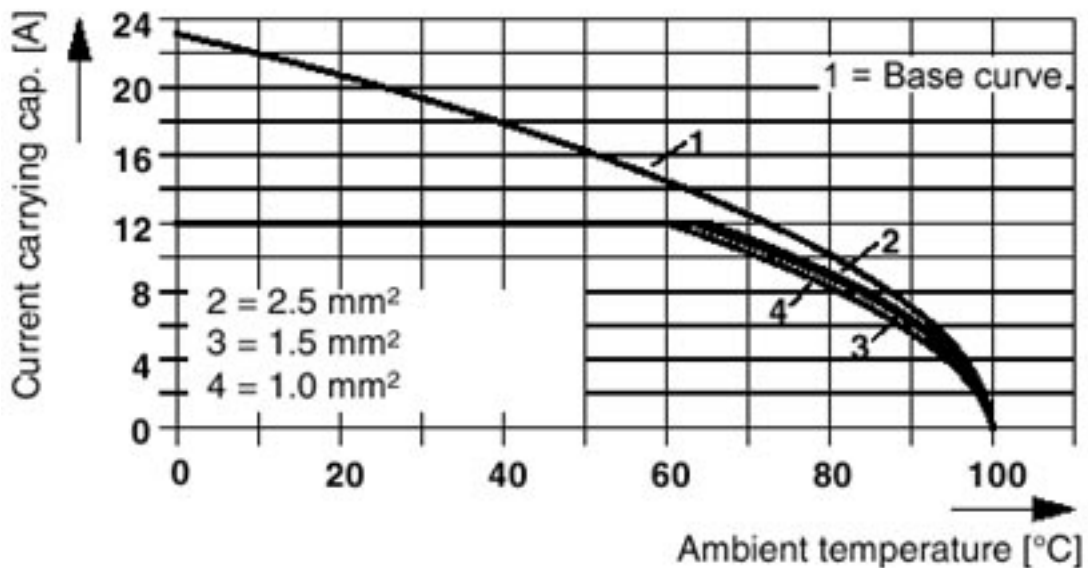

# Base strip - MSTBA 2,5/ 5-G-5,08 - 1757271

Diagram

Plug: TMSTBP 2,5/5-ST(F)-(-5,08)  
Header: MSTB(A) 2,5/5-G(F)-(-5,08)

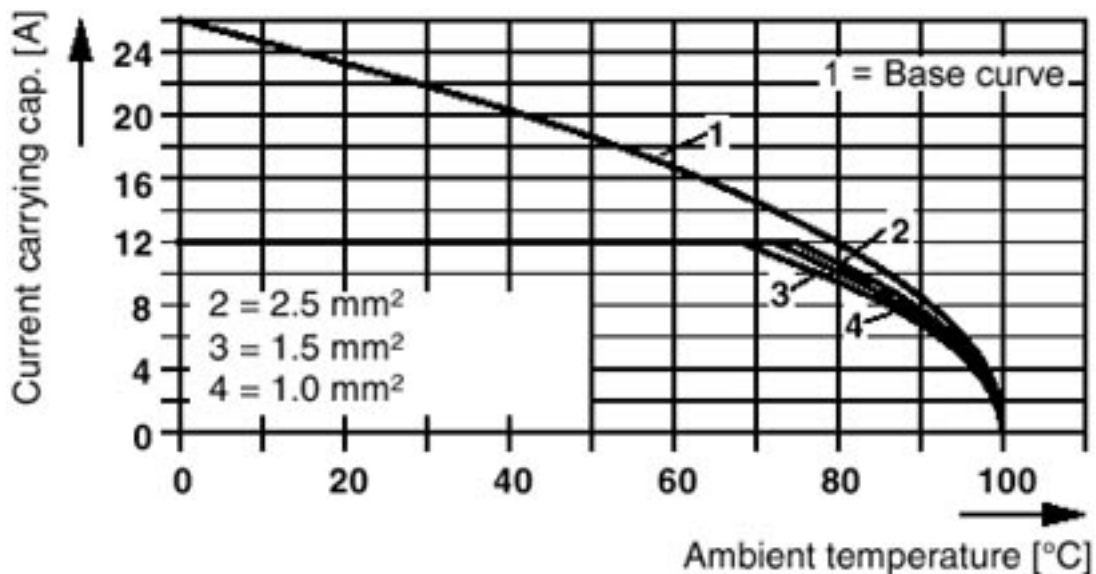

Diagram

Plug: FKC 2,5/5-ST(F)-5,08  
Header: MSTB(A) 2,5/5-G(F)-5,08

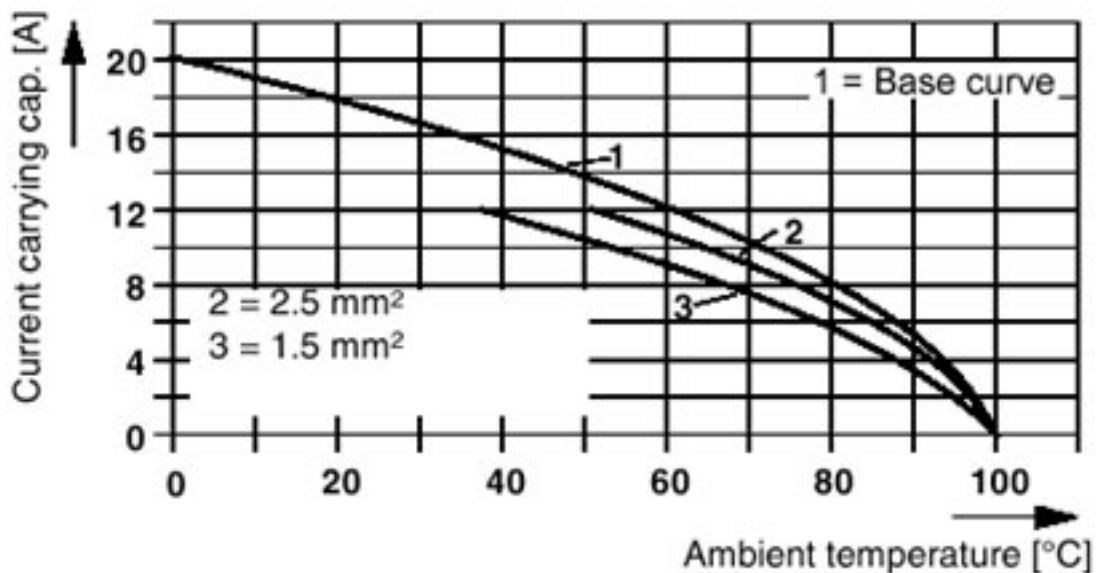

### Base strip - MSTBA 2,5/ 5-G-5,08 - 1757271

Diagram

Plug: FKCVR(W) 2,5/5-ST(F)-5,08  
Header: MSTB(A) 2,5/5-G(F)-5,08

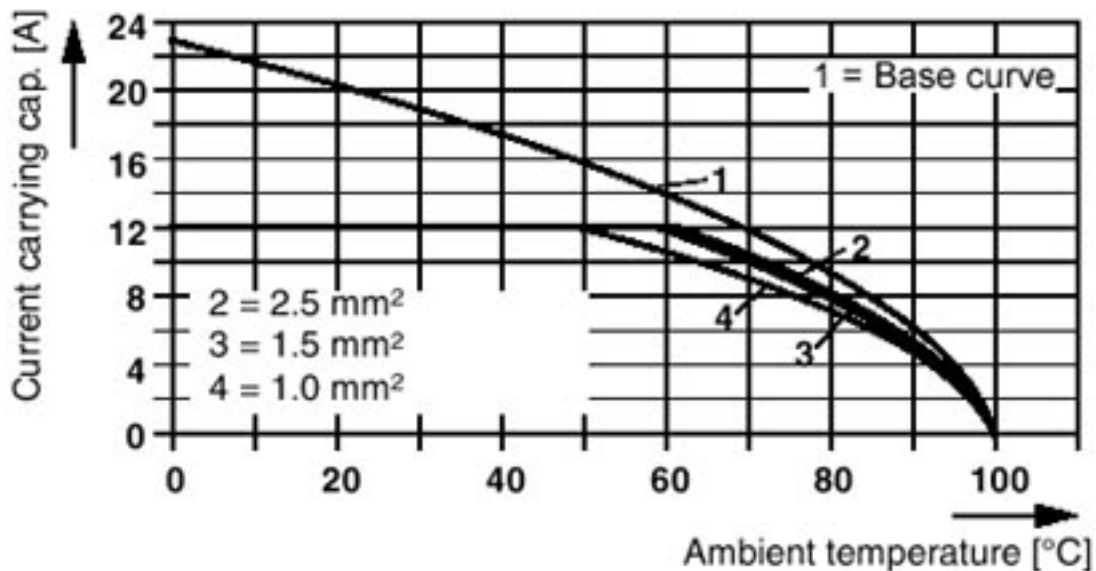

Diagram

Plug: MSTB 2,5/5-ST(F)(-5,08)  
Header: MSTBO 2,5/5-GR(L)(-5,08)

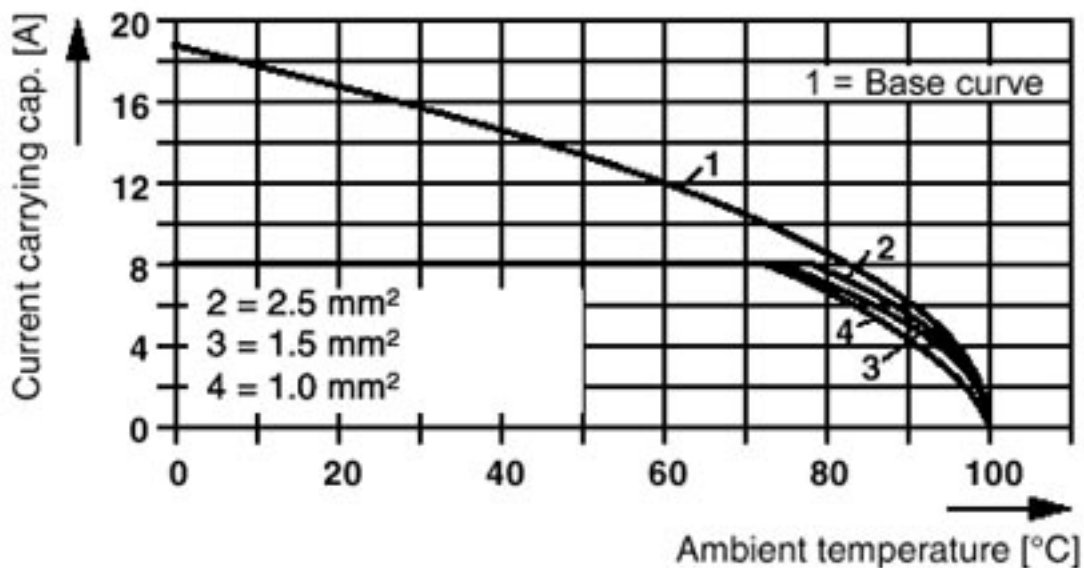

# Base strip - MSTBA 2,5/ 5-G-5,08 - 1757271

Diagram

Plug: MSTB 2,5/5-ST(F)-(-5,08)  
Header: MSTB(A) 2,5/5-G(F)-(-5,08)

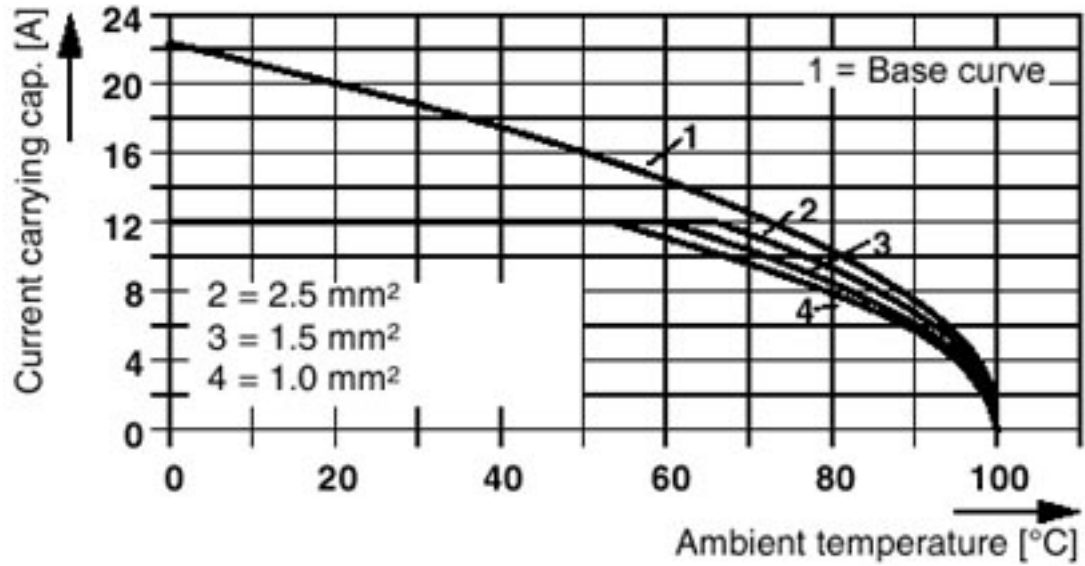

## X-ON Electronics

Largest Supplier of Electrical and Electronic Components

*Click to view similar products for [Pluggable Terminal Blocks](#) category:*

*Click to view products by [Phoenix Contact](#) manufacturer:*

Other Similar products are found below :

[57.404.7553](#) [57.504.0053.7](#) [57.510.0053](#) [57.910.6153](#) [01.112.1453](#) [CTB932VE/6](#) [MC 1.5/ 6-ST-3.5 GY AU](#) [ET02015000J0G](#) [734-104](#) [734-304](#) [8-141-P](#) [860505](#) [860516](#) [860810](#) [861908](#) [8726](#) [GBPACX-12](#) [93.731.4953.0](#) [PV05-5,08-K](#) [PVP02-5,00](#) [PVP04-3,50](#) [PVS02-5,00](#) [1-1986160-3](#) [H-10](#) [EC350V-05P](#) [ECH350V-06P](#) [EK381V4L-04P](#) [ELFH09150](#) [ELFH16150](#) [ELFP03110](#) [ELFP10210](#) [ELFT06250](#) [ELFT07250](#) [ELVF09400](#) [ELVP03100](#) [ELXH071G0E](#) [ELXP041G0](#) [ELXT046G0](#) [1700101](#) [1700410](#) [1700425](#) [1703176](#) [1703243](#) [1703634](#) [1705229](#) [1710175](#) [1714537](#) [1719600](#) [1729386](#) [1734692](#)