

MUIW analog coupler component IN: 0...10 V - OUT: 4...20 mA

INPUT: 0...10 V DC
 OUTPUT: 4...20 mA
 Screw terminals

Image

- Input and output galvanically separated

Technical Data

Operating voltage range	24 V DC \pm 20 %, smoothed
Operating current	50...70 mA
voltage/current input	approx. 250 Ohm
Input frequency	max. 500 Hz
Output load	RL \leq 500 Ohm at output
Output current	max. 20 mA
Tolerance	\leq 0.5 %
Temperature range	0...+60 °C
Mounting method	DIN-rail mountable (EN 60715)
Dimensions H x W x D	90 x 6.2 x 65 mm

Input

Input resistor	approx. 200 kOhm
----------------	------------------

General data

Test isolation voltage	1.5 kV
------------------------	--------

Description

The Murrelektronik analog converters convert standard signal formats (0...10 V, 0...20 mA, 4...20 mA) galvanically separated into one of these signal formats. Due to an integrated current limiter the output is short-circuit and overload protected.
 Module MUIW ? 0/4...20 mA to 0/4...20 mA ? without auxiliary supply, Art. No. 6644225 on request.

Commercial data

Gross weight	171
Net weight	171
Weight unit	gram
Basic unit	pc.
Customs tariff number	85437090
Unit (piece)	1
Limited value	1

Circuit diagram

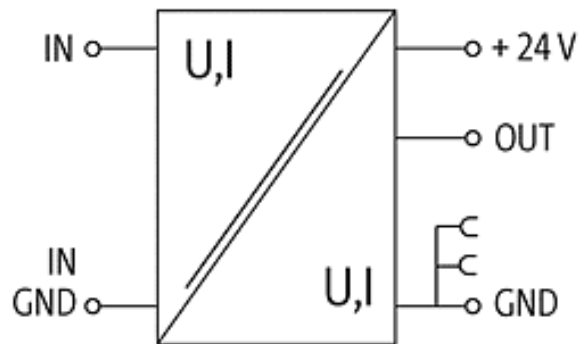

Dimension drawing

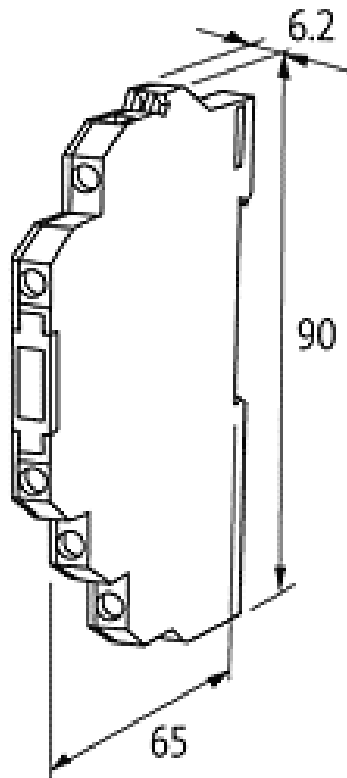

X-ON Electronics

Largest Supplier of Electrical and Electronic Components

Click to view similar products for [Measuring Tools](#) category:

Click to view products by [Murr Elektronik](#) manufacturer:

Other Similar products are found below :

[G336](#) [M225203-01](#) [G426](#) [G1333](#) [G1327](#) [G1154](#) [G1150](#) [G1152](#) [G1157](#) [G1153](#) [G1155](#) [G1009](#) [1051-03](#) [121010D](#) [121050D](#) [25541](#) [8255](#) [NF-221200130](#) [20323](#) [20363](#) [20365](#) [20368](#) [20516](#) [G800](#) [G1229](#) [1051-02](#) [1051-04](#) [1051-05](#) [1056-01](#) [1056-03](#) [LXA-112-012](#) [1100](#) [1125](#) [D1014D](#) [D1020D](#) [D1032Q](#) [D1033Q](#) [1150D](#) [1200](#) [121010GF](#) [121020D](#) [121030D](#) [121050GF](#) [31439 2](#) [33232](#) [UT107](#) [1500](#) [15922](#) [15923](#) [15924](#)