

PROGRAMMABLE CONTROL TIMER
 dual-channel

PCZ-522.3

WARRANTY. The F&F products are covered by a warranty of the 24 months from the date of purchase. Effective only with proof of purchase. Contact your dealer or directly with us. More information how to make a complaint can be found on the website: www.fif.com.pl/reklamacja



Do not dispose of this device to a garbage bin with other unsorted waste! In accordance with the Waste Electrical and Electronic Equipment Act any household electro-waste can be turned in free of charge and in any quantity to a collection point established for this purpose, as well as to the store in the event of purchasing new equipment (as per the old for new rule, regardless of brand). Electro-waste thrown in the garbage bin or abandoned in the bosom of nature pose a threat to the environment and human health.

PURPOSE

Programmable control timer is used to time control the devices in home or industrial automation systems according to an individual time program set by the user.

OPERATION

Timer activates and deactivates the device or electrical circuit on the programmed hours in cycles: daily, weekly, working days (Mon-Fri) or weekend (Sat, Sun). The timer has two independently programmable channels.

OPERATING MODES AND FUNCTIONS

CHANNEL – program line with individual entries for ON-OFF COMMANDS, which controls its own contact for enabling the receiver.

ON-OFF COMMAND – program entry for enabling or disabling the receiver.

500 MEMORY CELLS – memory for individual program entries that allows to program 250 pairs of ON-OFF COMMANDS.

AUTOMATIC MODE - operation by ON-OFF COMMANDS programmed by the user in the timer memory [highlighted icon on display]

MANUAL MODE - [ON] permanently closed contact (position 1-5) or [OFF] permanently open contact (position 1-6) when the AUTOMATIC MODE is off [no icon on display]

CYCLE - adjustable, weekly cycle (7 days from Monday to Sunday) of the receiver switching in accordance with the programmed ON-OFF COMMANDS:
 * single day of the week: Mo; Tu; We; Th; Fr; Sa or Su.
 * working days: Mo Tu We Th Fr (Monday to Friday).
 * weekend: Sa Su (Saturday and Sunday)
 * daily: Mo Tu We Th Fr Sa Su (Monday to Sunday).

AUTOMATIC TIME CHANGE - change from winter time to summer time with options to change automatically or not. User can set the time zone so that the switching time is consistent with the local time

DATE PREVIEW - the ability to preview the set date (OK).
CURRENT PROGRAM PREVIEW – pressing the +/- keys in the date preview mode displays information about the number and details of the current program.

NFC WIRELESS COMMUNICATION - wirelessly read and write timer configuration from an Android phone equipped with the NFC module.
PCZ Konfigurator APP - free application for Android mobile phones and tablets equipped with the NFC module for wireless communication.

Features: - timer configuration in Offline mode (without the connection with the PCZ-521 timer);
 - read and write the configuration of the controller;
 - quick programming of multiple controllers using a single configuration;
 - read and write the configuration from and to a file;
 - sharing the configuration via e-mail, Bluetooth, network drives...

- identification of the connected timer and the ability to name individual devices;
 - automatic backups of the configuration. Along with a unique identifier for each timer, user can easily restore previous configuration;
 - set the time and date according to the clock in mobile phone;
 The app is available on Google Play!

CLOCK TIME CORRECTION – set monthly adjustment of the seconds of the system clock.

BATTERY INDICATOR - the controller comes with built-in control system of the backup timer battery used in case of main power supply failure. If the battery is low, user will receive information that the battery needs to be replaced. Battery life depends on the ambient temperature and the degree of the battery wear.

LCD BRIGHTNESS ADJUSTMENT - change the contrast of the display to get a clear LCD read-out from different viewing angles.

RELAY STATE MEMORY - the relay state in manual mode will be remembered even after power supply failure.

DISPLAY AND CONTROL PANEL DESCRIPTION

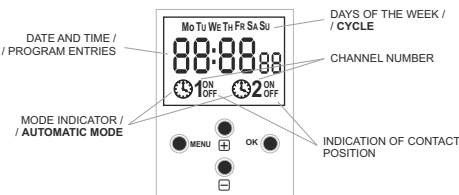

Mo – Monday; Tu – Tuesday; We – Wednesday; Th – Thursday; Fr – Friday; Sa – Saturday; Su – Sunday.

FUNCTION KEYS DESCRIPTION

MENU:

- enter the program menu
- return to the previous position (back).

OK:

- move to the next setting
- accept setting
- preview of the date

+ [Plus]:

- change the setting by one position up for the selected programming option (holding down the button continuously changes the setting by one position up in a loop)

- in MANUAL MODE: permanent ON and OFF contact switching

- [Minus]:

- change in the setting by one position down for the selected programming option (holding down the button continuously changes the setting by one position down in a loop)

- in MANUAL MODE: permanent ON and OFF contact switching

PROGRAMMING

1. START

- 1.1 Connect the power supply.
- 1.2 The timer will start at the root level and the display will show selected hour.



In the absence of any program entries, timer will automatically run in manual mode. If the previous entries are present, timer will execute the program. To erase all previous settings, see section 5.6.

1.3 Set individual timer program with internal configuration menu or by using the "PCZ Konfigurator" app for mobile devices.

2. DATE

Press MENU. The timer will enter program menu. Using the +/- buttons select the date setting mode [date]

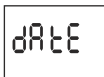

Confirm with OK.

Timer will show settings for the next parameters: year, month, and day. Use the +/- keys to set the parameters; move to the next parameter with the OK button. Go back to the previous item by pressing MENU.



Press OK to accept date setting. The timer will automatically exit from the date setting mode and go to the program menu.

The date setting is tantamount to time determination: winter or summer. In Poland, the time change from winter to summer is done automatically at night, on the last Sunday of March at 2.00 AM (by adding one hour to the current time). Time change from summer to winter is done automatically at night, on the last Sunday of October at 3.00 AM (by subtracting one hour from the current time).

PLEASE NOTE!

The automatic time change can be turned off (see section 5.1).

3. TIME

Press MENU. The timer will enter the program menu. Using the +/- buttons select the mode for time setting [hour]

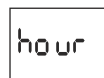

Timer will show settings for the next parameters: hour and minutes. Set the parameters with the +/- buttons. Move to the next parameter with the OK button. Go back to the previous item by pressing MENU.



Press OK to accept time entry. The timer will automatically exit from the date setting mode and go to the program menu.

4. CHANNEL – Selecting a channel number and setting its parameters

Press MENU. The clock will enter the program menu. Using +/- buttons select the mode for the date setting: "Chn 1" or "Chn 2".



Select channel 1 or 2, and accept with OK button.

Timer will show the submenu of the selected channel parameter settings: on-off commands, edit, delete and mode select. Select the desired entry with the +/- buttons. Open the desired item with OK button. OK. Press MENU button to return to the main MENU.

4.1 ON-OFF COMMAND - setting the parameters

Using the +/- buttons select the mode for the date setting [prog].

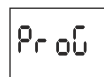

Press OK to accept. The clock will enter the memory cell number selecting mode. The display will automatically show the number of the first empty memory cell.

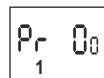

Press OK to accept (or select another number using the +/- keys). Clock will enter the single ON-OFF COMMAND parameters setting mode.

A. Operation cycle



Set OPERATION CYCLE using the +/- keys:

- * single day of the week: Mo; Tu; We; Th; Fr; Sa or Su.
 - * working days: Mo Tu We Th Fr (Monday to Friday).
 - * weekend: Sa Su (Saturday and Sunday)
 - * daily: Mo Tu We Th Fr Sa Su (Monday to Sunday)
- Press OK to accept.

B. Hour and minutes

Timer will show setting for the next parameters: hour and minutes. Set the values using +/- keys; move to the next parameter with the OK button. Go back to the previous item by pressing MENU.



C. ON / OFF

Timer will allow to choose [ON] or [OFF] option.



Set ON or OFF using +/- keys; confirm with OK. Timer will automatically enter the next ON-OFF COMMAND parameter input mode. Go back to the previous item by pressing MENU.

PLEASE NOTE!

* The registered ON-OFF commands do not constitute solid pairs of commands for a contact opening and closing. They are treated as individual commands and executed in accordance with the specified time chronology. Cases of overlapping contact closing times from two pairs of ON-OFF commands are illustrated in the following diagrams:

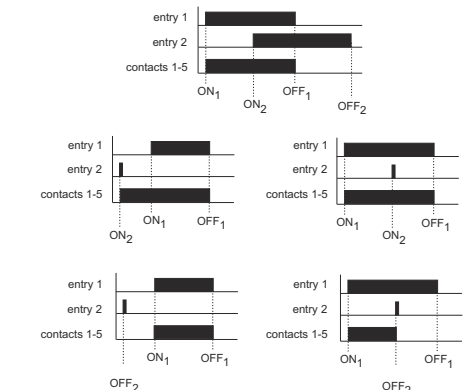

* Time of contact closing established by a pair of ON-OFF commands can be longer than 24 hours, which means that [ON] command can be set to any time and any day of the week (e.g. Tuesday, 1:45 PM) and [OFF] command to any hour of any other day of the week (e.g. Thursday, 5:05 PM).

4.2 EDITION OF ON / OFF COMMANDS PARAMETERS

Using the +/- keys select the parameter edit mode "edit"

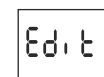

Press OK to accept. The timer will enter the memory cell number selecting mode. Select the cell to edit and accept by pressing OK.



Proceed as with ON-OFF COMMAND parameters setting (see section 5.1).

4.3 DELETION – removing entries

Using the +/- keys select ON-OFF COMMANDS reset mode "del".

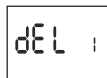

Press OK to accept. The timer will enter the memory cell number selecting mode. Select the cell to be deleted and accept by pressing OK. The timer will be waiting for confirmation. This is indicated by alternating flashing of the number of the selected cell and its set parameters.



Confirm by pressing OK. The cell will be deleted. The timer will display the next programmed cell number. Pressing MENU will take you to the root level.

PLEASE NOTE!

To erase all previous ON-OFF COMMANDS settings see section 5.6.

4.4 OPERATION MODE

Using the +/- keys select "mode".

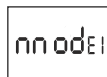

Accept by pressing OK. The timer will enter work mode menu (auto – hand). With +/- keys select desired operation mode:

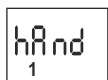
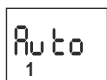

*MANUAL – "hand"
*AUTOMATIC – "auto"

Accept by pressing OK. The timer will automatically exit the operation mode selection and go to the program menu. Pressing Menu one more time will take the timer back to the root menu.

PLEASE NOTE!

To change the contact position in the MANUAL OPERATION mode use the +/- keys at the root level. In the absence of any program entries timer will automatically run in MANUAL MODE (there is no option to set AUTOMATIC OPERATION MODE).

5. SYSTEM SETTINGS

Press MENU. The timer will enter the program menu. Using the +/- keys select system settings "syst".

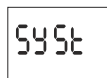

Confirm by pressing OK. The timer will enter the System Settings submenu (dst - utc - batt - cal - lcd - clear - info). Select the parameter with the +/- keys and confirm with OK. Pressing MENU will take you to the upper level.

5.1 Automatic time change – dst



DST – Daylight Saving Time – international name of summer time. Confirm by pressing OK. The timer will enter the menu with the option to disable automatic time change (auto-off). With +/- keys select desired mode:

* with AUTOMATIC TIME CHANGE – "auto"
* without AUTOMATIC TIME CHANGE – "off"



5.2 Time zone – utc



Confirm by pressing OK. The timer will display current parameter for time zone (12/-12). Pressing +/- keys set time zone for the clock. Confirm by pressing OK. Time zone for Poland is +1.



5.3 Battery charge indicator – batt



Confirm by pressing OK. The clock will display information about battery charge level.

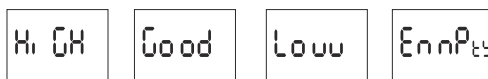

HIGH - fully charged, new battery.
GOOD - in good condition, provides long-term operation.
LOW - low battery level, recommended replacement.
EMPTY - discharged, it must be replaced immediately.

5.4 System clock time adjustment - cal

Time adjustment is the number of seconds by which the system clock is adjusted per month. Setting range: +/- 300 seconds.

For example:
If the clock is fast 4 seconds per month, set the parameter value -4.

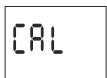

Confirm by pressing OK. The timer will display current parameter of time adjustment. Press +/- keys to set desired number of seconds. Confirm by pressing OK.



5.5 Display contrast - lcd

Setting the display contrast. Range: -3 (lowest) ... +3 (highest).

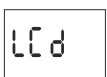

Confirm by pressing OK. The clock will display the current contrast parameter. Use the +/- keys to set the contrast parameter. Confirm by pressing OK.



5.6 Resetting the commands, parameter settings and errors - clear

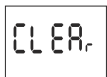

Confirm by pressing OK. The timer will enter the submenu (prog - sys - error). Use the +/- keys to select reset option.

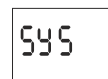
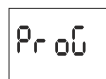

Confirm by pressing OK. The timer will enter the submenu (prog - sys - error). Use the +/- keys to select reset option:

* "prog" – deletion of ON/OFF entries
* "sys" – deletion of system settings

Confirm by pressing OK.

A. prog

Confirm selected option by pressing OK. The timer will enter standby mode awaiting for deletion confirmation. This is indicated by alternating flashing of "prog" and "clear" on display.



Confirm by pressing OK. The timer will start deleting entries. The display will count off consecutive numbers of deleted entries (from 1 to 500). Upon completion the display will show "prog".



B. sys

Confirm selected option by pressing OK. The timer will enter standby mode awaiting for deletion confirmation. This is indicated by alternating flashing of "sys" and "clear" on display.



Confirm by pressing OK. The timer will start deleting entries. Upon completion the display will show "sys".

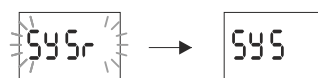

C. error

If the timer system detects an error, the display will show "error" message at the root level. At the same time in the "clear" section the extra "error" item will appear. Error reset is possible only through the menu (menu -> syst -> clear -> error).

Confirm the "error" option by pressing OK. The timer will enter standby mode awaiting for deletion confirmation. This is indicated by alternating flashing of "error" and "clear" on display.



Confirm by pressing OK. The timer will reset the error. The display will show "error". The clock will return to standard operation mode.

5.7 System information – info

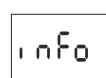

Confirm by pressing OK. The timer will enter the information menu. Browse the information by pressing +/- keys:

* clock type
* software version

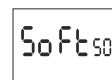
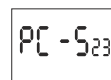

BATTERY REPLACEMENT

User can single-handedly replace the battery. Detailed instructions with pictures and videos can be found on the website www.fif.com.pl on the subpage of the timer. Battery type: 2032 (lithium).

SPECIFICATIONS

power input	24±264V AC/DC
current load	2x<16A
contact	2x separated 1NO/NC
up time of the clock (for T=20°C)	6 years
battery type	2032 (lithium)
up time of the display operation	no information
the accuracy of the clock	1s
time error	±1s/24h
precision of program time setting	1min.
program memory cell	500
	(2x 125 pairs of ON-OFF COMMANDS/CHANNEL)
power consumption	1.5W
operating temperature	-20÷50°C
terminal	2.5 mm ² screw terminals
tightening torque	0.4Nm
dimensions	2 modules (35mm)
mounting	on TH-35 rail
ingress protection	IP20

INSTALLATION

1. Turn off the power.
2. Mount the timer on the TH rail in the distribution box.
3. Connect wires according to the diagram.
4. Connect receivers according to the diagram.
5. Set the correct date (see section 2) and time (see section 3).
6. Set individual switch-on time programs for receivers.

IN/OUT DESCRIPTION

AC/DC	3-4	timer power supply
1	1	CHANNEL 1
5	1	COM contact input
6	5	NO contact output
6	6	- "standard open" position
6	6	NC contact output
6	6	- "standard closed" position
2	2	CHANNEL 2
7	2	COM contact input
7	7	NO contact output
7	7	- "standard open" position
7	7	NC contact output
7	7	- "standard closed" position

CONNECTION SCHEME

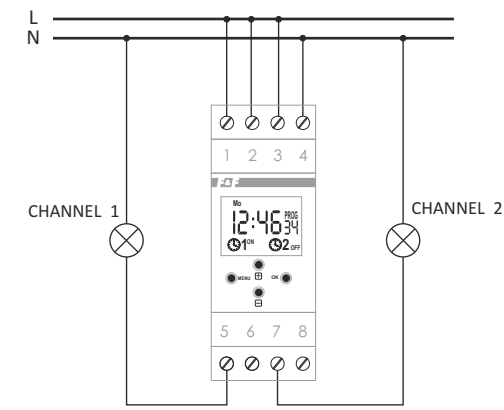

Programming scheme

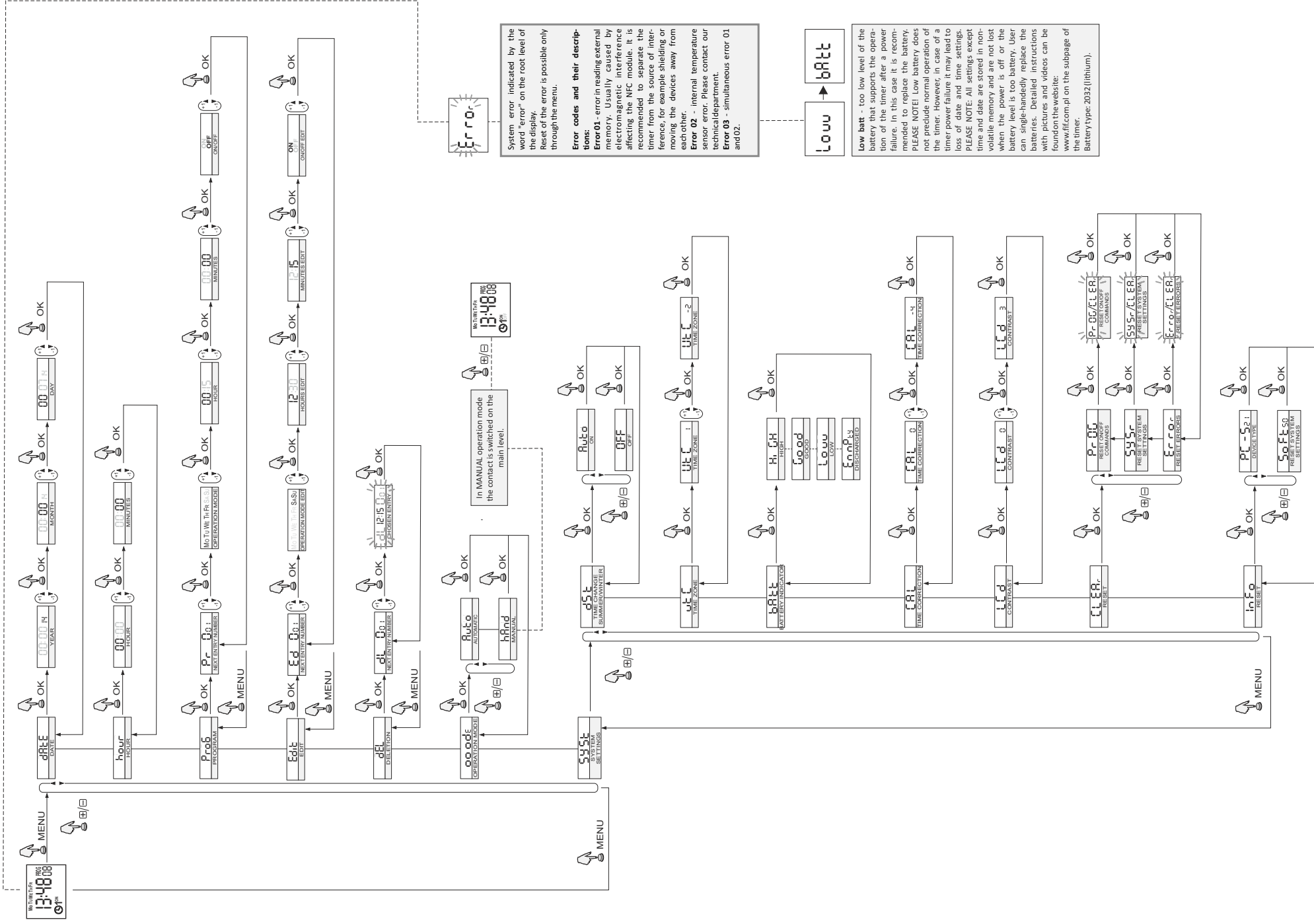

System error indicated by the word "error" on the root level of the display.
 Reset of the error is possible only through the menu.

Error codes and their descriptions:
Error 01 - error in reading external memory. Usually caused by electromagnetic interference affecting the NFC module. It is recommended to separate the timer from the source of interference, for example shielding or moving the devices away from each other.
Error 02 - internal temperature sensor error. Please contact our technical department.
Error 03 - simultaneous error 01 and 02.

LOW → bAtt

Low batt - too low level of the battery that supports the operation of the timer after a power failure. In this case it is recommended to replace the battery. PLEASE NOTE! Low battery does not preclude normal operation of the timer. However, in case of a timer power failure it may lead to loss of date and time settings. PLEASE NOTE: All settings except time and date are stored in non-volatile memory and are not lost when the power is off or the battery level is too battery. User can single-handedly replace the batteries. Detailed instructions with pictures and videos can be found on the website: www.fif.com.pl on the subpage of the timer.
 Battery type: 2032 (lithium).

Configurator PCZ App

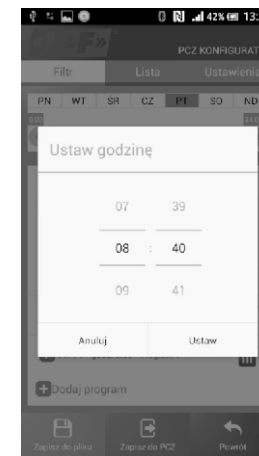
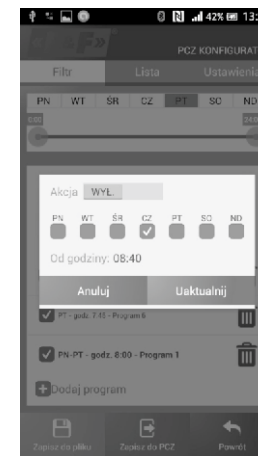
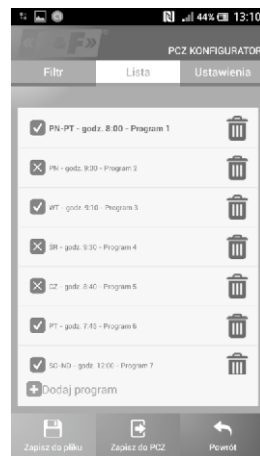
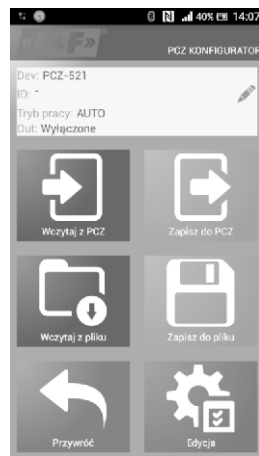

Main window

- 1) New configuration – opens window for creation of a new controller configuration.
- 2) Open configuration- opens window for loading the program configuration stored as a file in the phone memory.
- 3) My device - gives access and support for all backup copies of configurations assigned to specific devices.
- 4) Information – application user guide

New configuration

- 1) New – creates new, empty configuration file (without any programs).
- 2) Load from PC – new configuration is created based on a program saved in the PCZ controller. Select this option and bring the phone closer to the timer to load the program from the phone to the application.
- 3) Load from file - new configuration is created based on a files saved by the user. Opens a window with a list of files previously saved by the user.
- 4) Restore - a new configuration is created based on a backup copy of one of the previous configuration. Tapping this icon opens window with a list of backups split into controllers in which they were written. Select a new configuration option opens another window.

The function window allows to edit program as well as to load and save configuration to a PCZ controller. It appears automatically when we bring the phone closer to the controller, or when we create a new configuration. In the upper part of the screen the application displays a frame with following information:

Dev – supported controller type
 ID – unique identifier of connected controller (appears only when the application is connected with the controller. In the Offline mode that field remains empty). Icon of a pencil on the right-hand side allows you to enter your own name for the controller.
 Operating mode – displays the current operating mode for the controller (manual or automatic). Applies only to operating in Online Out mode – Output relay status (enabled or disabled). Applies only in Online mode.
 Keys:

- 1) Read the timer configuration.
- 2) Save the current configuration to the timer.
- 3) Load configuration from file.
- 4) Save the current configuration to file.
- 5) Restore configuration from backup copies.
- 6) Edit the current configuration.

Edit

Editing window allows you to edit current configuration (new, loaded from file or from PCZ)

- Editing window consists of three tabs:
- 1) List - a list of all programs (in the order in which they are stored in the memory).
 - 2) Filter - a list of programs that will be executed on the selected day (in chronological order by program execution).
 - 3) Settings – system settings configuration.

List

Main part of the screen is taken by the list of PCZ programs. Programs are displayed sorted by the time they are written in the controller memory.

Each program is symbolized by:
 · action icon - the green "v" means that the specific program will activate relay. Red "x" means deactivation of relay.
 · Date and time – show days of programs activation and their start time.

· Program number - program position in the controller memory. Bold font marking represents a program that is (or should be) executed. Pressing the trash bin icon next to the program entry deletes program. To add a new program select "Add Program". To edit an existing program tap into the edited program. The three icons at the bottom of the screen allow you to:

- Save to file - saves the current configuration to a file.
- Save to PCZ - saves the configuration to a timer.
- Back - returns to the function window. Upon returning to the function window, current configuration is stored in application memory.

Filter

Filter tab performs a similar function to List. In this case, at the top of the screen appears addition frame for choosing the day and time interval for which the application displays a list of programs active during that time. Programs are displayed in chronological order, sorted by the time of their actual execution.

Adding and editing programs

- Add or edit program displays a window with following options:
- Operation – selects whether the program will turn the relay on or off.
 - Day – selects the days of program execution. You can select a single day, Monday - Friday, Saturday - Sunday, all week.
 - Time – selects the time of program execution.

Application available on:



<https://play.google.com/store/apps/details?id=pl.com.fif.clockprogramer>

X-ON Electronics

Largest Supplier of Electrical and Electronic Components

Click to view similar products for [Timers](#) category:

Click to view products by [F&F](#) manufacturer:

Other Similar products are found below :

[79237785](#) [H3DS-GL AC24-230/DC24-48](#) [H5AN-4DM DC12-24](#) [H5CN-XDNM AC100-240](#) [H5CN-YAN AC100-240](#) [H5CX-L8S-N AC100-240](#) [H3AMNSCAC100240](#) [H3AM-NSR-B AC100-240](#) [H3CA-8 DC12](#) [H3CR-A8-302 DC24](#) [H3CR-F AC24-48/DC12-48](#) [H3CR-G8EL AC200-240](#) [H3Y4DC245S](#) [H5AN-4D DC12-24](#) [81506944](#) [88225029](#) [H5S-YB4-X](#) [H3CR-A-301 AC100-240/DC100-125](#) [H3CR-AS AC24-48/DC12-48](#) [H3DK-GE AC240-440](#) [H3RN-2 AC24](#) [H3RN-21 AC24](#) [H3CR-H8RL AC/DC24 M](#) [H3CR-H8RL AC100-120 S](#) [H3CR-G8EL-31 AC100-120](#) [H3CR-H8RL AC100-120 M](#) [H3CR-HRL AC100-120 M](#) [H3CR-A8-301 AC24-48/DC12-48](#) [H3AM-NSR-C AC100-240](#) [H3CR-H8RL AC/DC24 S](#) [H7AN-2D DC12-24](#) [H5CN-XANS DC12-48](#) [H3CA-8 DC110](#) [H7AN-W4DM DC12-24](#) [H7AN-4DM DC12-24](#) [H7AN-4D DC12-24](#) [H7AN-RT6M AC100-240](#) [H3CA-8H AC200/220/240](#) [MTR17-BA-U240-116](#) [PM4HSDM-S-AC240VS](#) [PM4HSDM-S-AC240VSW](#) [PO-405](#) [600DT-CU](#) [H3Y-2-B DC24 30S](#) [H3Y-2-B DC24 1S](#) [PM4HF8-M-DC24V](#) [PM4HS-H-DC12VSW](#) [H3Y-2-B AC100-120 10S](#) [H3Y-2-B AC100-120 30S](#) [H3C-R](#)