

# Amphenol®



## PT Series

Miniature Cylindrical Connectors

12-070-19

## Table of Contents Page

Introduction, Amphenol® Miniature Cylindrical	
General Information, Design Flexibility . . . . .	1, 2
Connector Selection Guide . . . . .	3
Insert availability . . . . .	4, 5
Alternate positioning . . . . .	6
Insert arrangement patterns . . . . .	7-10
PT, SP, MS/PT Proprietary/MIL-DTL-26482, Series 1	
<b>Bayonet Coupling, Solder Contacts</b>	
General Information, Specifications, Service Class . . . . .	11, 12
PT00 (MS3110), SP00 wall mounting receptacle . . . . .	13
PT01 (MS3111) cable connecting receptacle . . . . .	14
PT02 (MS3112) SP02 box mounting receptacle . . . . .	15
PT06 (MS3116) SP06 straight plug . . . . .	16
PT07 (MS3114) SP07 jam nut receptacle . . . . .	17
PT08E, SP08E 90 degree plug . . . . .	18
PT Connectors with Printed Circuit Board Contacts -	
box mount receptacle, jam nut receptacle . . . . .	19
PTB, SPB thru bulkhead receptacle . . . . .	20
General Information, Specifications - PT hermetic . . . . .	21
PTIH (MS3113H) hermetic solder mounting receptacle . . . . .	22
PT02H hermetic box mounting receptacle . . . . .	23
PT07H (MS3114H) hermetic jam nut receptacle . . . . .	24
PT, SP, MS/PT how to order . . . . .	25
PT-SE, SP-SE, MS/PT-SE Proprietary/MIL-DTL-26482, Series 1	
<b>Bayonet Coupling, Crimp Contacts</b>	
General Information, Specifications, Service Class . . . . .	26, 27
PT00SE (MS3120), SP00SE wall mounting receptacle . . . . .	28
MF00SE (MS3128) wall mounting receptacle . . . . .	29
PT01SE (MS3121) SP01SE cable connecting receptacle . . . . .	30
PT02SE (MS3122) SP02SE box mounting receptacle . . . . .	31
MF02SE (MS3127) box mounting receptacle . . . . .	32
PT06SE (MS3126), SP06SE straight plug . . . . .	33
PT07SE (MS3124) SP07SE jam nut receptacle . . . . .	34
PT08SE, SP08SE 90 degree plug . . . . .	35
PT-SE, SP-SE, MS/PT-SE how to order . . . . .	36
Accessories . . . . .	37-40
Glands . . . . .	41
Application tools . . . . .	42
Contacts, Power and Thermocouple Crimp . . . . .	43
Contacts, Shielded Coax . . . . .	44-48
Mounting Recommendations . . . . .	49
Other Amphenol Miniature Cylindrical Connectors . . . . .	50

If more information is needed concerning the connectors covered in this publication, or if there are special application needs, please contact:

### Amphenol Corporation Amphenol Industrial Operations

191 Delaware Avenue  
Sidney, New York 13838-1395  
Telephone: 888-364-9011  
Fax: 520-397-7169

Please go to the Amphenol websites to view, download and save this catalog and most all of Amphenol interconnection product literature.

[www.amphenol-industrial.com](http://www.amphenol-industrial.com)

Some miniature connector styles are available in RoHS Compliant versions. Please contact Amphenol Industrial Operations for more information.

Amphenol operates Quality Systems that are certified to ISO 9001:2015; ISO 14001:2015; ISO/TS 16949:2016 by third party registrars.

#### NOTE:

The connector products in this brochure were formerly known as Bendix® products. These products are now manufactured and sold under the Amphenol® brand name. The name "Amphenol" will replace the name "Bendix" on products and literature in the future.

#### NOTE:

The Miniature MIL-DTL-26482, Series 2 connectors PTS-DR and MS/PTS-DR (formerly in this catalog) are no longer supplied with these designations. Amphenol now supplies the Amphenol®/Matrix® MIL-DTL-26482, Series 2. (Military numbers include MS3470 - MS3472, MS3474, - MS3476).

**Proprietary/MIL-DTL-26482 Series 1 connectors covered in this catalog are widely used in general duty and environmental applications, both industrial and military. Markets that use this family of connectors include:**

- Instrumentation
- Monitoring Equipment
- Machine Tool, Factory Automation
- Communications
- Geophysical
- Industrial Controls and Robotics
- Oil and Petrochemical Industries
- Rail/Mass Transit
- Military/Aerospace

# Amphenol® Miniature Cylindrical Connectors

## Proprietary/MIL-DTL-26482, Series 1

Amphenol® Miniature Cylindrical connectors offer twice the number of contacts in just half the size of a Standard connector. These miniature connectors, are available in several series, each with varying design characteristics and customer options to meet cost considerations and provide maximum design flexibility. There are two styles within the family that are MS approved and qualified to MIL-DTL-26482, Series 1, and in addition there are several proprietary styles.

Common features of all styles:

- All are for general duty applications and environmental sealing is achieved with the grommet and clamp design.
- Operating temperature is from -55°C to +125°; Operating voltage to 1000 VAC (RMS) at sea level.
- Pin and socket contacts are machined from low loss copper alloy and gold plated to eliminate contact corrosion and provide an indefinite shelf life.
- All have resilient inserts which provide high dielectric strength and moisture barrier.
- A variety of shell finishes (including non-cadmium) and a variety of back-end accessories are available within the styles.



**PT Solder  
jam nut receptacle and  
mated straight plug**



**PT Solder  
wall mount receptacle**



**PT-SE Crimp  
wall mount receptacle  
and mated straight plug**

### Bayonet Coupling with Solder Contact Termination

#### PT, MS/PT (solder)

- MS and proprietary versions
- Factory installed solder contacts
- 3 point bayonet coupling and 5 key/key-way mating.
- Intermateable with all miniature series connectors.
- MS/PT meets MIL-DTL-26482 Series 1, service classes E, F and P.
- MS/PT is UL recognized.

#### Options

- 7 shell styles with 60 insert patterns
- Hermetic seal (glass fusion) receptacle styles available
- Pressurized thru bulkhead receptacle style available
- Per-installed coax solder contacts are available
- Printed circuit board contacts are available

#### SP (solder)

- SP Series is a modification of the PT with same features except a wider flange for back panel mounting

### Bayonet Coupling with Crimp Contact Termination

#### PT-SE, MS/PT-SE (crimp)

- MS and proprietary versions
- Crimp rear insertable/front release contact termination. (closed entry socket insert prevents probe damage).
- 3 point bayonet coupling and 5 key/key-way mating.
- Intermateable with all miniature series connectors.
- MS/PT-SE meets MIL-DTL-26482 Series 1, service classes E, F, P.

#### Options

- 6 shell styles with 47 insert patterns
- Coax and thermocouple contacts are available

#### SP-SE (crimp)

- Modification of the PT-SE with wider flange for back panel mounting

# Amphenol Miniature Cylindrical design flexibility

The large family of miniature proprietary and MS style connectors provides for many optional features and designs. In addition to the choices of bayonet or threaded shells, solder or crimp termination within the style variations, there are additional options that are shown here.

## Hermetics

Hermetically sealed receptacles have fused compression glass sealed inserts which provide environmental moisture sealing. There are three hermetic styles within the PT bayonet series.



PT Connector with Hermetic Seal Insert and Coax Contacts



PT Connector with PC Tail Contacts

## Coaxial Contacts

Amphenol Miniature connectors can incorporate shielded coax contacts. Size 8 and 12 crimp coax contacts are available in PT-SE, SP-SE, MS/PT-SE. Factory installed size 8 and 12 solder type coax contacts are available in PT, SP, MS/PT connectors. See coax contact information pages at the end of this catalog.

## Printed Circuit Board Tail Contacts

PT bayonet connectors in box mounting receptacle and jam nut receptacle styles are available with printed circuit board contacts. Standard PCB tails for MIL-DTL-26482 connectors have gold plating, .0050 inches over nickel. See page 20 and call Amphenol for further information.



PT Connector with Flex

## Flex Circuitry

Flex termination assemblies for attaching cylindrical connectors to printed circuit boards are available through the Amphenol division ACT, Advanced Circuit Technology. Flex can be used with miniature 26482 connectors and it can be designed to meet specific length, current carrying capacity and to fit the precise geometric shape of the connector to board package. Flex circuitry plugs into a printed circuit board and creates a self-locking terminal pad which eliminates the need for an additional interconnect to the PCB.

## Filter Protection

Amphenol offers the FPT Series which combines the miniature PT series with an EMI filter. Designed to provide EMI protection for sensitive circuits, each circuit is individually filtered within the connector, eliminating the need for costly and bulky exterior network filters. Filter contacts are available in MF, HF, VHF, and UHF ranges and are intermateable and intermountable with MIL-DTL-26482 connectors. For further information see catalog 12-120, Amphenol EMI Filter Transient Protection Connectors.



PT Connector with EMI Filter Protection

## Overmolded Cable

Overmold seals and cables can be designed for almost any industrial application. A variety of materials are available: neoprene, hypalon and others; and a variety of lengths can be designed to meet customer specifications. Overmold seals to the rear of the connector and to the cable jacket providing moisture sealing.



PT Connector with Overmolded Cable

# Amphenol Miniature Cylindrical connector selection guide

The accompanying chart is provided to assist the user in selecting the appropriate type of miniature connector to meet the application requirements. Further information can be found in specific sections of this catalog.

CHARACTERISTICS		Solder			Crimp	
		PT	MS/PT	SP	MS/ PT-SE	PT-SE
Intermateable†		O	O	O	O	O
Contacts	Solder	•	•	•		
	Crimp Ri/FR				•	•
Contact Retention System	Non-Removable	•	•	•		
	Removable				•	•
Coupling	Bayonet	•	•	•	•	•
Standard Finishes††	Olive Drab Cadmium (003)	•	•		•	•
	Anodic Coated (005)			•		
Temperature Range	Resilient Dielectric (-55°C to +125°C)	•	•	•	•	•
Wide Mounting Flange				•		
Hermetic Seal		•	•	•		
SHELL STYLE AVAILABILITY						
Wall Mounting Receptacle "00"		•	•	•	•	**•
Cable Connecting Receptacle "01"***		•	•		•	•
Box Mounting Receptacle "02"		*•	•	•	•	**•
Straight Plug "06"		•	•	•	•	•
Jam Nut receptacle "07"		*•	*•	•	•	•
thru-bulkhead Receptacle "TB"		•		•		
Solder Mount Receptacle "I"		*•	*•			
90° Plug "08"		•		•		•

RI/FR = Rear Insertion/Front Releasable

† o intermates with o

†† Optional finishes available. See "how to order" sections.

\* Available in hermetic version

\*\* Dual mounting holes

\*\*\* This connector style is sometimes referred to as a cable connecting "plug."

It does, however, mate with either a straight or 90 degree plug.



# Amphenol Miniature Cylindrical

## insert availability

Insert Arrangement	Solder Termination				Crimp Termination	Screw Termination	Total Contacts	Contact Size							
	MS/PT	PT	SP	Hermetic PT MS-PT	MS/PT-SE PT-SE SP-SE	PT		20	16	12	10	8	Coax		Service Rating
													12	8	
6-1		X	X	X*			1	1							I
8-2	X	X	X	X			2	2							I
8-3	X	X	X	X			3	3							I
8-4	X	X	X	X			4	4							I
8-33	X	X	X	X	X		3	3							I
8-98		X	X				3	3							I
10-2		X	X				2		2						I
10-5		X	X	X*			5	5							I
10-6	X	X	X	X	X		6	6							I
10-7		X	X	X			7	7							I
10-70		X	X				1						1	Coax	
10-98	X	X	X	X*			6	6							I
12-3*	X	X	X	X	X		3		3						II
12-4		X	X	X*			4		4						I
12-8	X	X	X	X*	X		8	8							I
12-10	X	X	X	X	X		10	10							I
12-14		X	X				14	14							I
12-98		X	X				10	10							I
14-2		X	X				2			2					II
14-4		S	S	X			4			4					I
14-5	X	X	X	X	X		5		5						II
14-8		X	X				8	6		2					I
14-12	X	X	X	X	X		12	8	4						I
14-15	X	X	X	X	X		15	14	1						I
14-18	X	X	X	X*	X		18	18							I
14-19	X	X	X	X	X		19	19							I
14-22					X*		5	1		4					I
14-71		P	X				4		3						I
14-91 HV		S	X		X*		3	3					1	**	
14-AA		X	X	X			4			4					I
16-8	X	X	X	X	X		8		8						II
16-23	X	X	X		X		23	22	1						I
16-26	X	X	X	X	X		26	26							I
16-70		X	X				15	14					1	N/A	
16-76†††					X*		14	8		1			5	***	
16-99	X	X	X		X		23	21	2						I
18-2		X	X	X			2				2				II
18-3		X	X	X			3				3				II
18-5		X	X		X*		5			5					II
18-8							8			8					I
18-11	X	X	X	X	X		11		11						II
18-30	X	X	X	X*	X		30	29	1						I

\*Not available in MS version  
 \*\*Flashover voltage 5,000 VAC (RMS)  
 \*\*\*1500 VAC (RMS)  
 S designates Socket insert only.

P designates Pin insert only.  
 †Size 12 contacts for #10 wire  
 ††Not presently tooled  
 †††Contacts must be ordered separately

# Amphenol Miniature Cylindrical

insert availability, cont.

Insert Arrangement	Solder Termination				Crimp Termination	Total Contacts	Contact Size					Service Rating
	MS/PT	PT	SP	Hermetic PT MS-PT	MS/PT-SE PT-SE SP-SE		20	16	12	Coax		
										12	8	
18-32	X	X	X	X	X	32	32					I
18-71					X*	9		8			1	Coax, II
18-72		X	X			14	10			4		N/A
18-75		X	X			4					4	Coax
18-76						4				3	1	II
18-80		X	X			8	6				2	Coax, I
18-91 HV					X*	6	6					**
20-16	X	X	X	X	X	16		16				II
20-24	X	X	X			24	24					I
20-25		X	X			25	25					I
20-26		X	X			26	26		6			I
20-27	X	X	X			27	27					I
20-39	X	X	X	X	X	39	39	2				I
20-41	X	X	X	X	X	41	41					I
20-70						14	10				4	Coax
20-90 HV		X	X			7	7					Hi-Voltage
22-7		X	X		X*	7					7	Coax
22-21	X	X	X	X	X	21		21				II
22-25					X*	25		25				I
22-32	X	X	X		X	32	32					I
22-34		X	X			34	34					I
22-36		X	X			36	36					I
22-41	X	X	X	X	X	41	27	14				I
22-55	X	X	X	X	X	55	55					I
22-70		X	X			19	13				6	I, Coax
22-71						9	2				7	I, Coax
22-72		X	X			19	12	4			3	N/A
22-78†††					X*	7					7	Coax
22-96					X*	7			7†			II
24-31		X	X			31		31				I
24-51†††					X*	51	47			4		I
24-61	X	X	X	X	X	61	61					I
24-71		X	X			49	45	2			2	N/A
24-79						1	1				5	Coax

\*Not available in MS version  
 \*\*Flashover voltage 5,000 VAC (RMS)  
 \*\*\*1500 VAC (RMS)

†Size 12 contacts for #10 wire  
 ††Not presently tooled  
 †††Contacts must be ordered separately

# Amphenol Miniature Cylindrical

## alternate positioning

### Alternate Positioning

To avoid cross-plugging problems in applications requiring the use of more than one miniature cylindrical connector of the same size and arrangement, alternate insert rotations are available as indicated in the accompanying chart.

As shown in the diagram at right, the front face of the pin insert is rotated within the shell in a clockwise direction from the normal shell key. The socket insert would be rotated counterclockwise the same number of degrees in respect to the normal shell key.

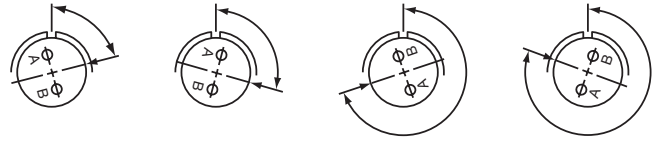

**Position W    Position X    Position Y    Position Z**

Views looking into front face of pin insert or rear of socket insert.

Insert Rotation					
Shell Size	Insert Arrangement	Degrees			
		W	X	Y	Z
6	6-1	-	-	-	-
8	8-2*	58	122	-	-
8	8-3	60	210	-	-
8	8-4*	45	97	184	-
8	8-33*	90	-	-	-
8	8-98	-	-	-	-
10	10-2	45	90	315	-
10	10-5*	45	151	180	270
10	10-6*	90	-	-	-
10	10-7	90	-	-	-
10	10-70	-	-	-	-
10	10-98*	90	180	240	270
12	12-3	-	-	180	-
12	12-4*	38	-	-	-
12	12-8	90	112	203	292
12	12-10*	60	155	270	295
12	12-14	-	-	-	-
12	12-98*	61	135	189	340
14	14-2	58	122	-	-
14	14-4*	45	-	-	-
14	14-5*	40	92	184	273
14	14-8	48	162	189	312
14	14-12*	43	90	-	-
14	14-15*	17	110	155	234
14	14-18*	15	90	180	270
14	14-19*	30	165	315	-
14	14-22	45	-	-	-
14	14-71	-	-	-	-
14	14-91HV	-	60	-	-
14	14-AA*	45	-	-	-
16	16-8*	54	152	180	331
16	16-23	158	270	-	-
16	16-26*	60	-	275	338
16	16-70	41	122	216	286
16	16-76	-	-	-	-
16	16-99*	66	156	223	340
18	18-2	58	122	-	-
18	18-3	-	-	180	-

Insert Rotation					
Shell Size	Insert Arrangement	Degrees			
		W	X	Y	Z
18	18-5	55	97	263	315
18	18-8	180	-	-	-
18	18-11*	62	119	241	340
18	18-30*	180	193	285	350
18	18-32*	85	138	222	265
18	18-71	18	108	127	215
18	18-72	53	102	213	293
18	18-75	45	-	-	-
18	18-76	-	-	-	-
18	18-80	45	90	135	160
18	18-91HV	90	180	240	270
20	20-16*	238	318	333	347
20	20-24	70	145	215	290
20	20-25	72	144	216	288
20	20-26	13	107	210	322
20	20-27	72	144	216	288
20	20-39*	63	144	252	333
20	20-41*	45	126	225	-
20	20-70	63	135	222	335
20	20-90	45	135	225	315
22	22-7	19	41	-	-
22	22-21*	16	135	175	349
22	22-25	60	125	211	336
22	22-32	72	145	215	288
22	22-34	62	142	218	298
22	22-36	72	144	216	288
22	22-41	39	135	264	-
22	22-55*	30	142	226	314
22	22-70	30	82	218	312
22	22-71	33	191	236	270
22	22-72	42	200	277	339
22	22-78	19	41	-	-
22	22-96*	19	41	-	-
24	24-31	90	225	255	-
24	24-51	22	171	313	-
24	24-61*	90	180	270	324
24	24-71	39	131	205	281
24	24-79	-	-	-	-

\* Available in Hermetic Class



# Amphenol Miniature Cylindrical

## insert arrangements

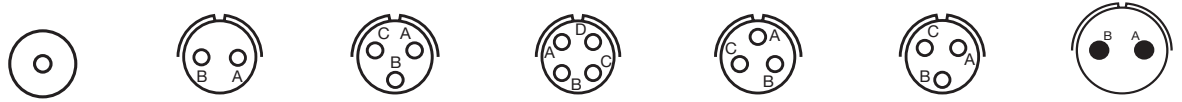

Insert Arrangement	6-1	8-2	8-3	8-4	8-33	8-98	10-2
Service Rating	I	I	I	I	I	I	I
Number of Contacts	1	2	3	4	3	3	2
Contact Size	20	20	20	20	20	20	16



Insert Arrangement	10-5	10-6	10-7	10-70	10-98	12-3	12-4
Service Rating	I	I	I	COAX	I	II	I
Number of Contacts	5	6	7	1	6	3	4
Contact Size	20	20	20	8 COAX	20	16	16

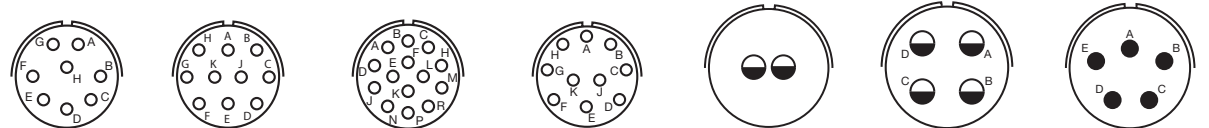

Insert Arrangement	12-8	12-10	12-14	12-98	14-2	14-4	14-5
Service Rating	I	I	I	I	II	I	II
Number of Contacts	8	10	14	10	2	4	5
Contact Size	20	20	20	20	12	12	16

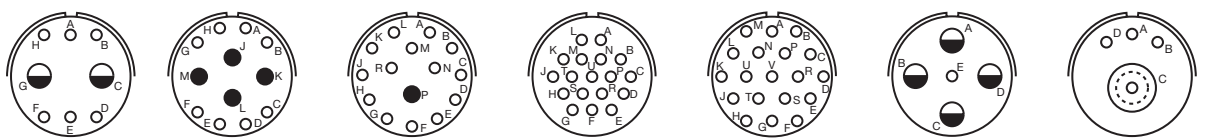

Insert Arrangement	14-8	14-12	14-15	14-18	14-19	14-22	14-71		
Service Rating	I	I	I	I	I	I	I		
Number of Contacts	6	2	8	4	14	1	3	1	
Contact Size	20	12	20	16	20	20	12	16	8 COAX

# Amphenol Miniature Cylindrical insert arrangements

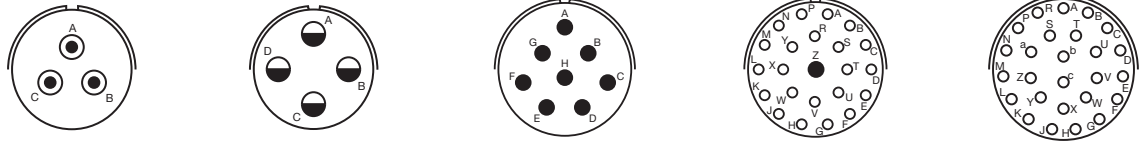

<b>Insert Arrangement</b>	14-91HV	14-AA	16-8	16-23	16-26	
<b>Service Rating</b>	Flashover 5,000 VAC (RMS)	I	II	I	I	
<b>Number of Contacts</b>	3	4	8	22	1	26
<b>Contact Size</b>	20	12	16	20	16	20

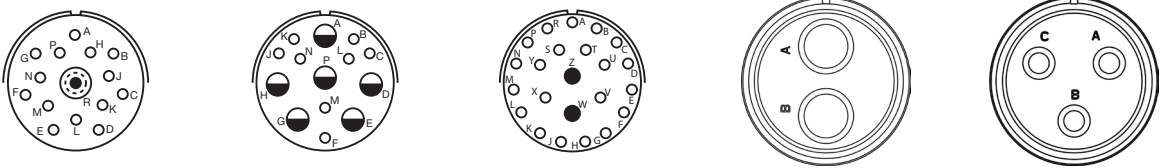

<b>Insert Arrangement</b>	16-70	16-76	16-99	18-2	18-3				
<b>Service Rating</b>	N/A	Flashover 1,500 VAC (RMS)	I	II	II				
<b>Number of Contacts</b>	14	1	8	1	5	21	2	2	3
<b>Contact Size</b>	20	12 COAX	20	12*	2 COAX	20	16	8	10

\*Contact Positions Optional

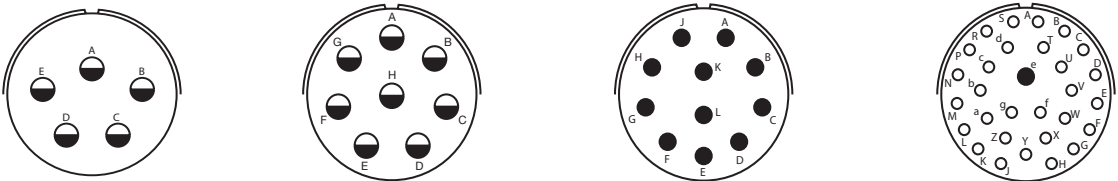

<b>Insert Arrangement</b>	18-5	18-8	18-11	18-30	
<b>Service Rating</b>	II	I	II	I	
<b>Number of Contacts</b>	5	8	11	29	1
<b>Contact Size</b>	12	12	16	20	16

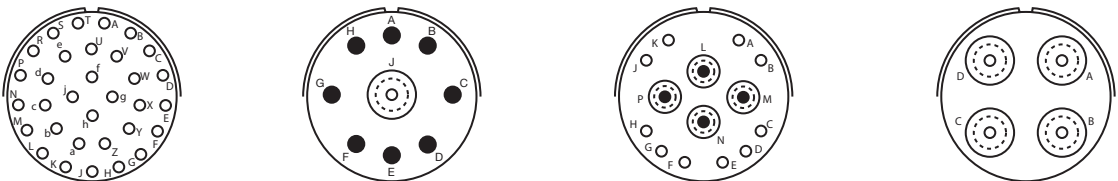

<b>Insert Arrangement</b>	18-32	18-71	18-72	18-75		
<b>Service Rating</b>	I	II, COAX	N/A	COAX		
<b>Number of Contacts</b>	32	8	1	10	4	4
<b>Contact Size</b>	20	16	8 COAX	20	12 COAX	8 COAX

# Amphenol Miniature Cylindrical insert arrangements

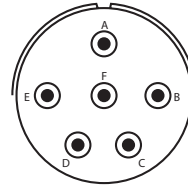
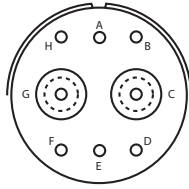
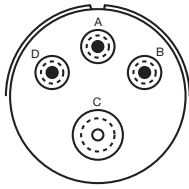

<b>Insert Arrangement</b>	18-76		18-80		18-91 HV		20-16
<b>Service Rating</b>	II		I, COAX		Flashover 5,000 VAC (RMS)		II
<b>Number of Contacts</b>	3	1	6	2	6		16
<b>Contact Size</b>	12 COAX	8 COAX	20	8 COAX	20		16

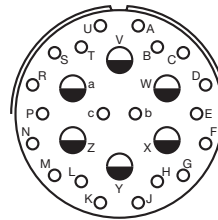
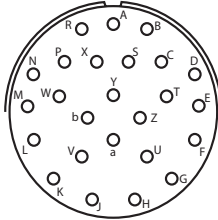

<b>Insert Arrangement</b>	20-24		20-25		20-26		20-27
<b>Service Rating</b>	I		I		I		I
<b>Number of Contacts</b>	24		25		20	6	27
<b>Contact Size</b>	20		20		20	12	20

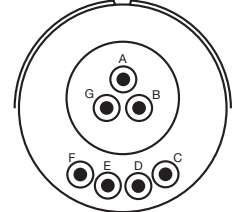
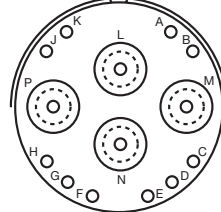
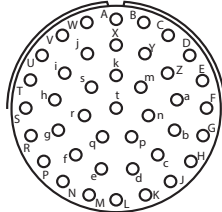
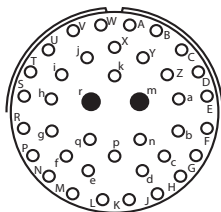

<b>Insert Arrangement</b>	20-39		20-41		20-70		20-90
<b>Service Rating</b>	I		I		COAX		HI-VOLTAGE
<b>Number of Contacts</b>	37	2	41		10	4	7
<b>Contact Size</b>	20	16	20		20	8 COAX	20

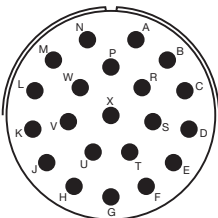
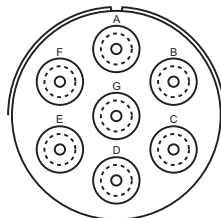

<b>Insert Arrangement</b>	22-7		22-21		22-25		22-32
<b>Service Rating</b>	COAX		II		I		I
<b>Number of Contacts</b>	7		21		25		32
<b>Contact Size</b>	8 COAX		16		16		20

# Amphenol Miniature Cylindrical insert arrangements

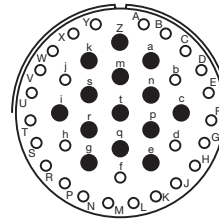

<b>Insert Arrangement</b>	22-34	22-36	22-41	22-55
<b>Service Rating</b>	I	I	I	I
<b>Number of Contacts</b>	34	36	27	55
<b>Contact Size</b>	20	20	20	20

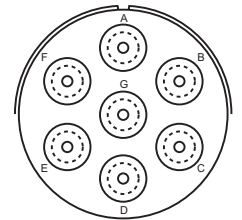
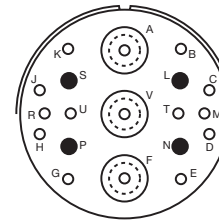
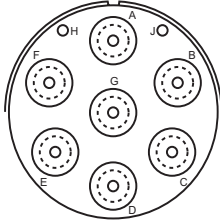
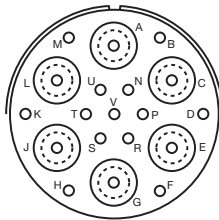

<b>Insert Arrangement</b>	22-70	22-71	22-72	22-78
<b>Service Rating</b>	i, COAX	I, COAX	N/A	COAX
<b>Number of Contacts</b>	12	2	12	7
<b>Contact Size</b>	20	20	20	20

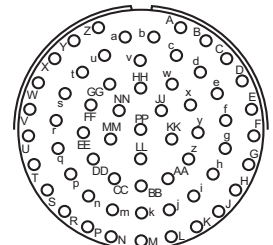
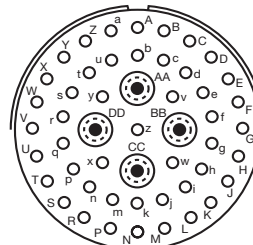
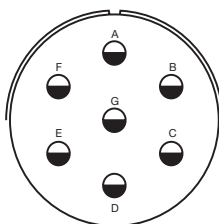

<b>Insert Arrangement</b>	22-96	24-31	24-51	24-61
<b>Service Rating</b>	II	I	I	I
<b>Number of Contacts</b>	7	31	47	61
<b>Contact Size</b>	12 for #10 WIRE	16	20	20

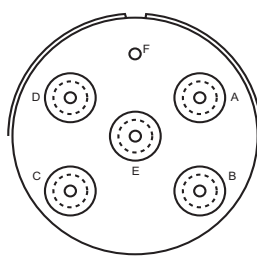

<b>Insert Arrangement</b>	24-71	24-79
<b>Service Rating</b>	N/A	COAX
<b>Number of Contacts</b>	45	5
<b>Contact Size</b>	20	20

Contact Legend	
Symbol	Contact Size
	20
	16
	12
	HV
	12 COAX
	8 COAX

# Amphenol PT, SP, MS/PT

## Proprietary/MIL-DTL-26482, Series 1 bayonet coupling and solder termination

**Amphenol® solder contact miniature cylindrical connectors meet the most critical application needs. Design versatility combined with high reliability performance makes these series of Miniature Cylindrical Connectors ideal for environmental sealing or pressurized applications.**

wall mounting receptacle



cable connecting receptacle\*



box mounting receptacle



straight plug



jam nut receptacle



thru bulkhead receptacle



The MS/PT Series is qualified to MIL-DTL-26482, Series 1 and has all the outstanding design characteristics and quality of the PT Series. The SP Series is a modification of the PT, providing special shells with a wide mounting flange for back panel mounting.

A corrosion resistant electrically conductive finish of cadmium plate with an olive drab chromate after-treatment is used on the PT and MS/PT. The SP is given a durable non-conductive hard anodic "Alumilite"® coating which provides abrasion protection and resistance to corrosion.

**\*\*NEW\*\*** 500 hour corrosion resistance, RoHS compliant harsh environment conductive plating. Gray Zinc over an Electroless Nickel (Gray ZnNi) base, with a Light Gun Metal Gray appearance.

Shell components for these series are aluminum. The dependable 5 key/keyway polarization with bayonet lock coupling assures positive mating with no chance of cross plugging. Spring tension provided by a wave washer in the coupling nut ensures maintenance of interfacial seal between mating halves.

Both the insert and main joint gasket are molded from resilient neoprene. This provides excellent moisture sealing at the gasket and superior electrical isolation of the contact in the insert.

Both pins and sockets are machined from a copper alloy and are gold plated. This gold plating eliminates contact corrosion and offers an indefinite shelf life. Socket contacts for these series are a closed entry design. A breakaway style plug is available in the PT solder series. Hermetics receptacles are available in PT and MS/PT solder series. Receptacles with printed circuit board contacts are also available.

PT Solder is UL recognized under file #E115497, Vol. 1, Sec. 5. The PT, SP and MS/PT Series are intermateable and intermountable with all existing Miniature Cylindrical Series connectors.

Refer to pages 4-10 for insert arrangement availability.

### PT, SP, MS/PT

**Table 1: CONTACT DATA/CONNECTOR RATINGS**

Contact Specifications					
Contact Size	Test Current	Maximum Millivolt Drop†	Solder Well Diameter		Solder Well Depth
20	7.5	55	.046	+0.004 -.000	.125 +.031 -.000
16	13.0	50	.078	+0.005 -.003	.188 +.031 -.000
12	23.0	42	.116	+0.004 -.002	.188 +.031 -.000
Service Rating					
Service Rating	Recommended Operating AC Voltage at Sea Level	Test Voltage AC (RMS), 60 cps			
		Sea Level	50,000 ft.	70,000 ft.	110,000 ft.
I	600	1,500	500	375	200
II	1,000	2,300	750	500	200

† Silver plated wire per MIL-DTL-26482

\* This connector style is sometimes referred to as a cable connecting "plug." It does, however, mate with a straight or 90 degree plug.

# Amphenol PT, SP, MS/PT

## Proprietary/MIL-DTL-26482, Series 1 bayonet coupling and solder termination, cont.

### PT, SP Service Classes

PT and SP connectors are available in the service classes listed below. Each class, with the exception of hermetic, offers one or more means of terminating or supporting a cable or wire bundle.

"A" General duty; back shell is threaded for conduit attachment of MS3057 cable clamp

"A" (SR) General duty, with strain relief clamp for cable or wire bundle support

"C" Pressurized receptacle; less than 1 cu. in. per hour leakage at 30 psi over a temperature range of -65°F to +257°F

"E" Environmental resistant connectors - supplied with a multi-holed grommet and clamping nut for moisture-proofing individual open wires

"E" (SR) Environmental resistant strain relief clamp and grommet for moisture proofing individual wires; provides added wire bundle support

"P" Translucent nylon boot for retaining customer-applied potting compounds; held in place by a threaded ring

"P" (SR) Strain relief clamp suitable for retaining customer applied potting compounds, with provision for wire support

"PG" Compressing gland for moisture proofing jacketed cables.

"H"\* Hermetically sealed with compression glass inserts (see pages 22-25)

Style with printed circuit board contacts- see page 20.

### MS/PT Service Classes

The MS/PT Miniature connector is available in the following certified service classes:

"E" Environmental resistant connectors - supplied with a multi-holed grommet and clamping nut for moisture-proofing individual open wires

"F" Grommet seal with strain relief clamp

"J" Compressing clamp and neoprene gland for moisture proofing multi-conductor jacketed cable and strain relief. Telescoping sleeves (MS 3420A) can be used to adapt to cables smaller than minimum close-down.

"P" Translucent nylon boot for retaining customer-applied potting compounds; held in place by a threaded ring

"A" general duty



"E" (SR), MS/"F" strain relief



"E", MS/"E" open wire seal



"P" MS/"P" potting boot



"PG" cable gland seal





# PT00 (MS3110)

## SP00

### wall mounting receptacle

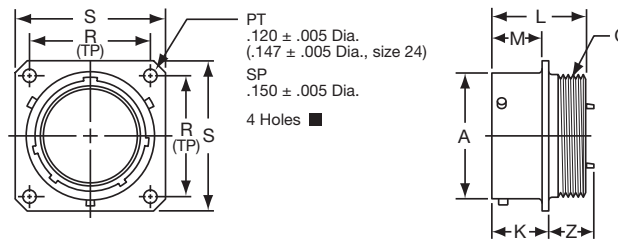

#### TERMINATION ASSEMBLIES

"A" General Duty/  
"C" Pressurized"

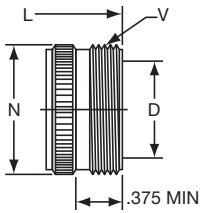

PT00A-XX-XXX  
SP00A-XX-XXX  
PT00C-XX-XXX

"A" (SR), "E" (SR), "P" (SR),  
MS / "F" Strain Relief

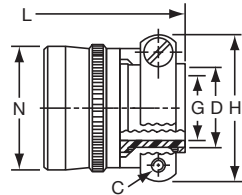

PT00A-XX-XXX (SR)  
SP00A-XX-XXX (SR)  
PT00E-XX-XXX (SR)  
SP00E-XX-XXX (SR)  
PT00P-XX-XXX (SR)  
SP00P-XX-XXX (SR)  
MS3110F-XX-XXX

"E" Open Wire Seal

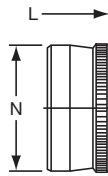

PT00E-XX-XXX  
SP00E-XX-XXX  
MS3110E-XX-XXX

"P" Potting Boot

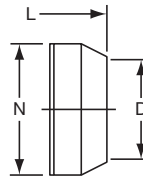

PT00P-XX-XXX  
SP00P-XX-XXX  
MS3110P-XX-XXX

"PG" Cable Gland Seal

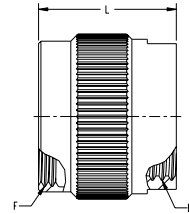

PT00PG-XX-XXX

"J" Cable Seal

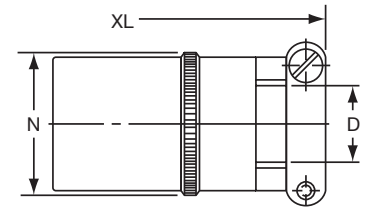

MS3110J-XX-XXX

To complete part number see how to order on page 25.

■ (MMC) located within .0025 of (TP)

Shell Size	Receptacle Front View				Receptacle Side View								Class "A", "C"				
	R (TP)		S Max.		A +.001 -.005	K +.020 -.010		L Max.	M +.010 -.000		Q Thread Class 2A	Z Max.		D Min.	L Max.	N Max.	V Thread Class A
	PT	SP	PT	SP		PT	SP		PT	SP		PT	SP				
6	.469	.641	.688	.953	.348	.493	.524	.906	.431	.462	.3125-32 NEF	.468	.438	.175	1.553	.462	.3750-32 NEF
8	.594	.734	.812	1.047	.473	.493	.524	.906	.431	.462	.4375-28 UNEF	.468	.438	.297	1.553	.590	.5000-28 UNEF
10	.719	.812	.938	1.125	.590	.493	.524	.906	.431	.462	.5625-24 NEF	.468	.438	.421	1.553	.717	.6250-24 NEF
12	.812	.938	1.031	1.250	.750	.493	.524	.906	.431	.462	.6875-24 NEF	.468	.438	.546	1.553	.834	.7500-20 UNEF
14	.906	1.031	1.125	1.344	.875	.493	.524	.906	.431	.462	.8125-20 UNEF	.468	.438	.663	1.553	.970	.8750-20 UNEF
16	.969	1.125	1.219	1.438	1.000	.493	.524	.906	.431	.462	.9375-20 UNEF	.468	.438	.787	1.553	1.088	1.0000-20 UNEF
18	1.062	1.203	1.312	1.516	1.125	.493	.524	.906	.431	.462	1.0625-18 NEF	.531	.438	.879	1.553	1.216	1.1875-18 NEF
20	1.156	1.297	1.438	1.672	1.250	.650	.650	1.125	.556	.556	1.1875-18 NEF	.531	.531	1.014	1.703	1.332	1.1875-18 NEF
22	1.250	1.375	1.562	1.750	1.375	.650	.650	1.125	.556	.556	1.3125-18 NEF	.531	.531	1.134	1.703	1.460	1.4375-18 NEF
24	1.375	1.500	1.688	1.875	1.500	.650	.650	1.125	.589	.556	1.4375-18 NEF	.498	.498	1.259	1.765	1.585	1.4375-18 NEF

Shell Size	Class "A" (SR), "E" (SR), "P" (SR), MS/"F"						Class "e", MS/"E"		Class "P", MS/"P"			Class "J"				Class "PG"	
	C Thread	D Min.	G Max.	H Max.	L Max.	N Max.	L Max.	N Max.	D Min.	L Max.	N Max.	D		N Max.	XL Max.	B Thread	L Max.
												Closed	Free				
6	-	-	-	-	-	-	1.266	.440	.192	1.438	.484	-	-	-	-	-	-
8	6-32	.240	.125	.812	1.922	.550	1.266	.560	.317	1.438	.608	.168	.230	.547	2.271	M12x1.5-6H	.936
10	6-32	.302	.188	.875	1.922	.675	1.266	.685	.434	1.438	.734	.205	.312	.675	2.271	M16x1.5-6H	.936
12	6-32	.428	.312	1.000	1.922	.803	1.266	.813	.548	1.438	.858	.338	.442	.812	2.411	M16x1.5-6H	.936
14	6-32	.552	.375	1.125	1.922	.920	1.266	.930	.673	1.438	.984	.416	.539	.940	2.599	M18x1.5-6H	.936
16	6-32	.615	.500	1.188	2.047	1.047	1.266	1.057	.798	1.438	1.110	.550	.616	1.067	2.943	M22x1.5-6H	.936
18	8-32	.740	.625	1.438	2.078	1.165	1.266	1.175	.899	1.438	1.234	.600	.672	1.194	3.172	M25x1.5-6H	.936
20	8-32	.740	.625	1.438	2.344	1.290	1.516	1.301	1.024	1.656	1.360	.635	.747	1.322	3.610	M25x1.5-6H	1.180
22	8-32	.928	.750	1.625	2.344	1.418	1.516	1.430	1.149	1.656	1.484	.670	.846	1.449	3.766	M32x1.5-6H	1.180
24	8-32	.990	.800	1.719	2.406	1.543	1.578	1.555	1.274	1.717	1.610	.740	.894	1.576	3.985	M32x1.5-6H	1.180

All dimensions for reference only.

# PT01 (MS3111)

## cable connecting receptacle

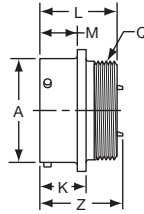
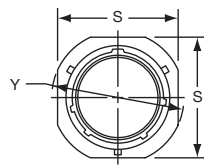

"PG" Cable Gland Seal

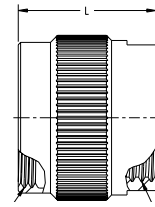

PT01PG-XX-XXX

"A" General Duty

"A" (SR), "E" (SR), "P" (SR), MS / "F" Strain Relief

### TERMINATION ASSEMBLIES

"E" Open Wire Seal

"P" Potting Boot

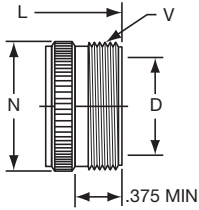

PT01A-XX-XXX

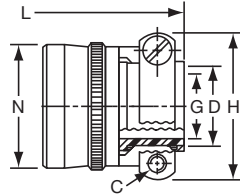

PT01A-XX-XXX (SR)  
PT01E-XX-XXX (SR)  
PT01P-XX-XXX (SR)  
MS3111F-XX-XXX

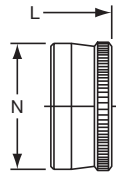

PT01E-XX-XXX  
MS3111E-XX-XXX

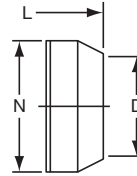

PT01P-XX-XXX  
MS3111P-XX-XXXX

"J" Cable Seal

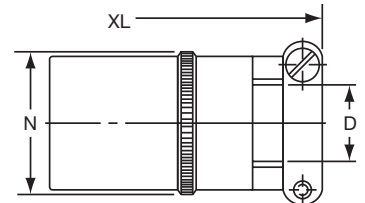

MS3116J-XX-XXX

Note: This connector style is sometimes referred to as a cable connecting "plug". It does, however, mate with either a straight or 90 degree plug. To complete part number see how to order on page 25.

Shell Size	Receptacle Front View		Receptacle Side View						Class "A", "C"				
	S ±.020	Y ±.020	A +.001 -.005	K +.020 -.010	L Max.	M +.016 -.000	Q Thread Class 2A	Z Max.	D Min.	L Max.	N Max.	V Thread Class A	
6	.688	.812	.348	.494	.906	.400	.3125-32 NEF	.948	.175	1.553	.462	.3750-32 NEF	
8	.812	.938	.473	.494	.906	.400	.4375-28 UNEF	.948	.297	1.553	.590	.5000-28 UNEF	
10	.938	1.062	.590	.494	.906	.400	.5625-24 NEF	.948	.421	1.553	.717	.6250-24 NEF	
12	1.031	1.156	.750	.494	.906	.400	.6875-24 NEF	.948	.546	1.553	.834	.6250-24 NEF	
14	1.125	1.250	.875	.494	.906	.400	.8125-20 UNEF	.948	.663	1.553	.970	.8750-20 UNEF	
16	1.219	1.344	1.000	.494	.906	.400	.9375-20 UNEF	.948	.787	1.553	1.088	1.0000-20 UNEF	
18	1.312	1.438	1.125	.494	.906	.400	1.0625-18 NEF	.948	.879	1.553	1.216	1.1875-18 NEF	
20	1.438	1.562	1.250	.650	1.125	.535	1.1875-18 NEF	1.166	1.041	1.703	1.332	1.1875-18 NEF	
22	1.562	1.688	1.375	.650	1.125	.535	1.3125-18 NEF	1.166	1.135	1.703	1.460	1.4375-18 NEF	
24	1.688	1.812	1.500	.683	1.188	.568	1.4375-18 NEF	1.166	1.259	1.703	1.585	1.4375-18 NEF	

Shell Size	Class "A" (SR), "E" (SR), "P" (SR), MS/"F"						Class "e", MS/"E"		Class "P", MS/"P"			Class "J"				Class "PG"	
	C Thread	D Min.	G Max.	H Max.	L Max.	N Max.	L Max.	N Max.	D Min.	L Max.	N Max.	D		N Max.	XL Max.	B Thread	L Max.
6	-	-	-	-	-	-	1.266	.440	.192	1.438	.484	-	-	-	-	-	-
8	6-32	.240	.125	.812	1.922	.550	1.266	.560	.317	1.438	.608	.168	.230	.547	2.271	M12x1.5-6H	.936
10	6-32	.302	.188	.875	1.922	.675	1.266	.685	.434	1.438	.734	.205	.312	.675	2.271	M16x1.5-6H	.936
12	6-32	.428	.312	1.000	1.922	.803	1.266	.813	.548	1.438	.548	.338	.442	.812	2.411	M16x1.5-6H	.936
14	6-32	.552	.375	1.125	1.922	.920	1.266	.930	.673	1.438	.673	.416	.539	.940	2.599	M18x1.5-6H	.936
16	6-32	.615	.500	1.188	2.047	1.047	1.266	1.057	.798	1.438	.798	.550	.616	1.067	2.943	M22x1.5-6H	.936
18	8-32	.740	.625	1.438	2.078	1.165	1.266	1.175	.899	1.438	.899	.600	.672	1.194	3.172	M25x1.5-6H	.936
20	8-32	.740	.625	1.438	2.344	1.290	1.516	1.301	1.024	1.656	1.024	.635	.747	1.322	3.610	M25x1.5-6H	1.180
22	8-32	.928	.750	1.625	2.344	1.418	1.516	1.430	1.149	1.656	1.149	.670	.846	1.449	3.766	M32x1.5-6H	1.180
24	8-32	.990	.800	1.719	2.406	1.543	1.516	1.555	1.274	1.717	1.274	.740	.894	1.576	3.985	M32x1.5-6H	1.180

All dimensions for reference only.

# PT02 (MS3112)

# SP02

## box mounting receptacle

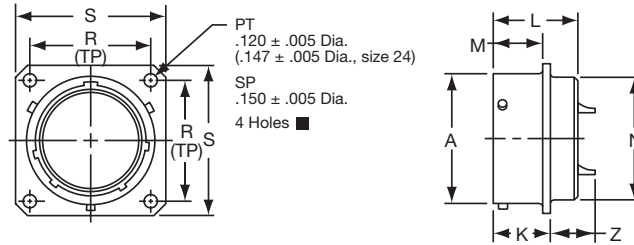

- PT02A-XX-XXX
- SP02A-XX-XXX
- \* PT02C-XX-XXX
- \* SP02C-XX-XXX
- \* PT02E-XX-XXX
- \* SP02E-XX-XXX
- MS3112E-XX-XXX
- \* PT02P-XX-XXX
- \* SP02P-XX-XXX
- MS3112P-XX-XXX

To complete part number see how to order on page 25.

■ (MMC) located within .0025 of (TP)

\* The PT02 and SP02 box mounting receptacles are made only to complete a series; no provision is made for accessories or potting on the rear skirt.

Shell Size	Receptacle Front View				Receptacle Side View								
	R (TP)		S		A +.001 -.005	K +.020 -.010		L Max.	M +.031 -.000		N Dia. Max.	Z Max.	
	PT	SP	PT	SP		PT	SP		PT	SP		PT	SP
6	.469	.641	.688	.953	.348	.493	.524	.825	.431	.462	.323	.465	.438
8	.594	.734	.812	1.047	.473	.493	.524	.825	.431	.462	.449	.465	.438
10	.719	.812	.938	1.125	.590	.493	.524	.825	.431	.462	.573	.465	.438
12	.812	.938	1.031	1.250	.750	.493	.524	.825	.431	.462	.699	.465	.438
14	.906	1.031	1.125	1.344	.875	.493	.524	.825	.431	.462	.823	.465	.438
16	.969	1.125	1.219	1.438	1.000	.493	.524	.825	.431	.462	.949	.465	.438
18	1.062	1.219	1.312	1.516	1.125	.493	.524	.825	.431	.462	1.073	.465	.438
20	1.156	1.312	1.438	1.672	1.250	.650	.650	1.076	.556	.556	1.199	.526	.531
22	1.250	1.438	1.562	1.750	1.375	.650	.650	1.076	.556	.556	1.323	.526	.531
24	1.375	1.562	1.688	1.875	1.500	.683	.683	1.109	.589	.589	1.449	.493	.497

All dimensions for reference only.

# PT06 (MS3116)

## SP06 straight plug

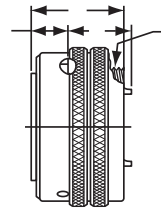
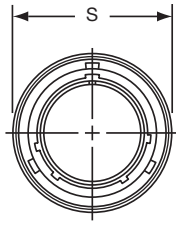

"PG" Cable Gland Seal

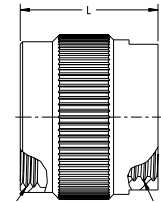

PT06PG-XX-XXX

"J" Cable Seal

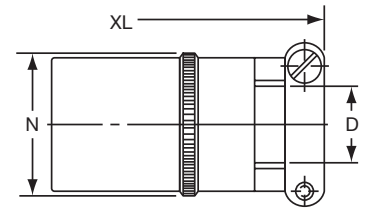

MS3116J-XX-XXX

### TERMINATION ASSEMBLIES

"A" General Duty

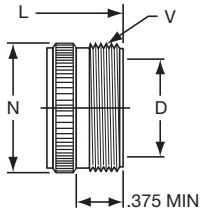

PT06A-XX-XXX  
SP06A-XX-XXX  
PTG06A-XX-XXX

"A" (SR), "E" (SR), "P" (SR),  
MS / "F" Strain Relief

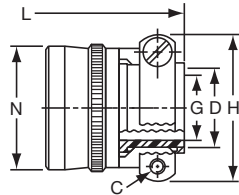

PT06A-XX-XXX (SR)  
SP06A-XX-XXX (SR)  
PTG06A-XX-XXX (SR)  
PT06E-XX-XXX (SR)  
SP06E-XX-XXX (SR)  
PTG06E-XX-XXX (SR)  
PT06P-XX-XXX (SR)  
SP06P-XX-XXX (SR)  
PTG06P-XX-XXX (SR)  
MS3116F-XX-XXX

"E" Open Wire Seal

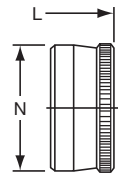

PT06E-XX-XXX  
SP06E-XX-XXX  
PTG06E-XX-XXX  
MS3116E-XX-XXX

"P" Potting Boot

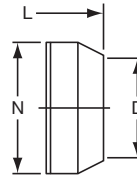

PT06P-XX-XXX  
SP06P-XX-XXX  
PTG06P-XX-XXX  
MS3116P-XX-XXX

To complete part number see how to order on page 25.

Shell Size	Plug Front View		Plug Side View				Class "A"			
	S Max.	J	L Max.	Q Thread Class 2A	Z Max.	D Min.	L Max.	N Max.	V Thread Class A	
6	.625	.353	.906	.3125-32 NEF	.594	.175	1.609	.462	1.4375-18 NEF	
8	.750	.353	.906	.4375-28 UNEF	.594	.297	1.609	.590	.5000-28 UNEF	
10	.859	.353	.906	.5625-24 NEF	.594	.421	1.609	.717	.6250-24 NEF	
12	1.013	.353	.906	.6875-24 NEF	.594	.546	1.609	.834	.7500-20 UNEF	
14	1.156	.353	.906	.8125-20 UNEF	.594	.663	1.609	.970	.8750-20 UNEF	
16	1.281	.353	.906	.9375-20 UNEF	.594	.787	1.609	1.088	1.0000-20 UNEF	
18	1.391	.353	.906	1.0625-18 NEF	.594	.879	1.609	1.216	1.1875-18 NEF	
20	1.531	.415	1.062	1.1875-18 NEF	.672	1.014	1.656	1.332	1.1875-18 NEF	
22	1.656	.415	1.062	1.3125-18 NEF	.672	1.135	1.656	1.460	1.4375-18 NEF	
24*	1.776	.415	1.125	1.4375-18 NEF	.672	1.259	1.750	1.587	1.4375-18 NEF	

Shell Size	Class "A" (SR), "E" (SR), "P" (SR), MS/"F"						Class "e", MS/"E"		Class "P", MS/"P"			Class "J"				Class "PG"	
	C Thread	D Min.	G Max.	H Max.	L Max.	N Max.	L Max.	N Max.	D Min.	L Max.	N Max.	D		N Max.	XL Max.	B Thread	L Max.
6	-	-	-	-	-	-	1.266	.440	.192	1.438	.484	-	-	-	-	-	-
8	6-32	.240	.125	.812	1.922	.550	1.266	.560	.317	1.438	.608	.168	.230	.547	2.271	M12x1.5-6H	.936
10	6-32	.302	.188	.875	1.922	.675	1.266	.685	.434	1.438	.734	.205	.312	.675	2.271	M16x1.5-6H	.936
12	6-32	.428	.312	1.000	1.922	.803	1.266	.813	.548	1.438	.858	.338	.442	.812	2.411	M16x1.5-6H	.936
14	6-32	.552	.375	1.125	1.922	.920	1.266	.930	.673	1.438	.984	.416	.539	.940	2.599	M18x1.5-6H	.936
16	6-32	.615	.500	1.188	2.047	1.047	1.266	1.057	.798	1.438	1.110	.550	.616	1.067	2.943	M22x1.5-6H	.936
18	8-32	.740	.625	1.438	2.078	1.165	1.266	1.175	.899	1.438	1.234	.600	.672	1.194	3.172	M25x1.5-6H	.936
20	8-32	.740	.625	1.438	2.344	1.290	1.516	1.301	1.024	1.656	1.360	.635	.747	1.322	3.610	M25x1.5-6H	1.180
22	8-32	.928	.750	1.625	2.344	1.418	1.516	1.430	1.149	1.656	1.484	.670	.846	1.449	3.766	M32x1.5-6H	1.180
24	8-32	.990	.800	1.719	2.406	1.543	1.578	1.555	1.274	1.717	1.610	.740	.894	1.576	3.985	M32x1.5-6H	1.180

All dimensions for reference only.

# PT07 (MS3114)

## SP07

### jam nut receptacle

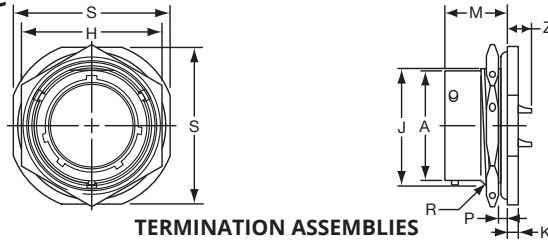

TERMINATION ASSEMBLIES

"A" General Duty/  
"C" Pressurized Receptacle  
**PT07A-XX-XXX**  
**PT07C-XX-XXX**

"E" Open Wire Seal

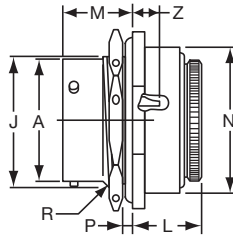

**PT07E-XX-XXX**  
**SP07E-XX-XXX**  
**MS3114E-XX-XXX**

"A" (SR), "E" (SR), "P" (SR),  
MS / "F" Strain Relief

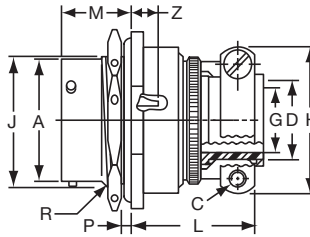

**PT07A-XX-XXX (SR)**  
**SP07A-XX-XXX (SR)**  
**PT07E-XX-XXX (SR)**  
**MS3114F-XX-XXX**

"P" Potting Boot

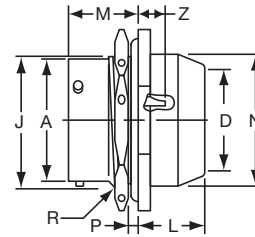

**PT07P-XX-XXX**  
**MS3114P-XX-XXX**

To complete part number see how to order on page 25.

Shell Size	Recept. Front View		Receptacle Side View							Class "E", MS/"E"				
	H ±.016	S	A Dia. +.001 -.005	J Flat +.000 -.010	K +.011 -.010	M	Panel Thickness		R Thread Class 2A UNEF	Z Max.	L Max.	M	N Max.	Z ±.040
							Min.	Max.						
6	.625	.812	.348	.405	.125	.696	.062	.125	.4375-28	.231	.568	.696	.604	.191
8	.750	.938	.473	.530	.125	.696	.062	.125	.5625-24	.231	.568	.696	.729	.191
10	.875	1.062	.590	.655	.125	.696	.062	.125	.6875-24	.231	.568	.696	.854	.191
12	1.062	1.250	.750	.818	.125	.696	.062	.125	.8750-20	.231	.568	.696	.979	.191
14	1.188	1.375	.875	.942	.125	.696	.062	.125	1.0000-20	.231	.568	.696	1.104	.191
16	1.312	1.500	1.000	1.066	.125	.696	.062	.125	1.1250-18	.231	.568	.696	1.229	.191
18	1.438	1.625	1.125	1.191	.125	.696	.062	.125	1.2500-18	.231	.568	.696	1.354	.191
20	1.562	1.812	1.250	1.316	.156	.884	.062	.250	1.3750-18	.261	.630	.884	1.510	.221
22	1.688	1.938	1.375	1.441	.156	.884	.062	.250	1.5000-18	.261	.630	.884	1.635	.221
24	1.816	2.062	1.500	1.566	.156	.917	.062	.250	1.6250-18	.228	.660	.917	1.760	.188

Shell Size	Class "A" (SR), "E" (SR), "P" (SR), MS/"F"						Class "E" (SR)						Class "P", MS/"P"				
	C Thread	D Max.	G	H	L	M	C Thread	D Max.	G	H	L	M	D Max.	L +.010 -.026	M	N	Z
6	-	-	-	-	-	-	-	-	-	-	-	-	.202	.593	.696	.484	.191
8	6-32	.250	.125	.781	1.062	.696	6-32	.250	.125	.775	1.029	.696	.327	.593	.696	.608	.191
10	6-32	.312	.188	.844	1.062	.696	6-32	.312	.188	.837	1.029	.696	.444	.593	.696	.734	.191
12	6-32	.438	.312	.969	1.062	.696	6-32	.438	.312	.963	1.029	.696	.558	.593	.696	.858	.191
14	6-32	.562	.375	1.094	1.062	.696	6-32	.562	.375	1.087	1.029	.696	.683	.593	.696	.984	.191
16	6-32	.625	.500	1.156	1.188	.696	6-32	.625	.500	1.150	1.161	.696	.808	.593	.696	1.110	.191
18	8-32	.750	.625	1.406	1.188	.696	8-32	.750	.625	1.400	1.161	.696	.909	.593	.696	1.234	.191
20	8-32	.750	.625	1.406	1.250	.884	8-32	.750	.625	1.400	1.224	.884	1.034	.718	.884	1.360	.221
22	8-32	.938	.750	1.594	1.250	.884	8-32	.938	.750	1.587	1.224	.884	1.159	.718	.884	1.484	.221
24	8-32	1.000	.800	1.594	1.250	.917	8-32	1.000	.800	1.681	1.320	.917	1.284	.718	.917	1.610	.188

\*Size 24 strain relief available in PT only

# PT08 E

# SP08 E

## 90 degree plug

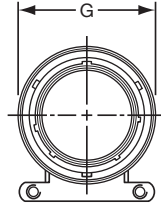

### TERMINATION ASSEMBLIES

"E" Open Wire Seal, "E" (SR)  
Strain Relief

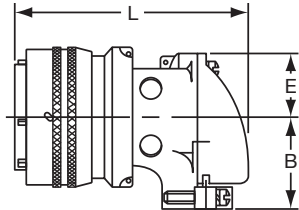

PT08E-XX-XXX  
SP08E-XX-XXX  
PT08E-XX-XXX (SR)  
SP08E-XX-XXX (SR)

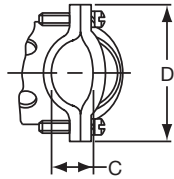

"P" Potting Boot 75 degrees

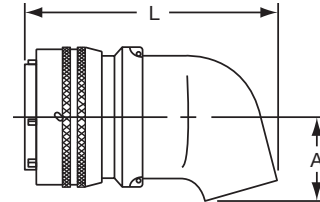

PT08P-XX-XXX  
SP08P-XX-XXX



To complete part number see how to order on page 25.  
All lockwire holes are .044 Dia. Min.

Shell Size	Plug Front View	Plug Side View								
	G Dia. Max	Class "E", "E" (SR)					Class "P"			
		B ±.031	C +.010 -.025	D ±.062	E +.047 -.025	L ±.057	A ±.025	H ±.015	K ±.015	L Max.
8	.796	.655	.169	.941	.339	1.786	.469	.312	.438	1.656
10	.921	.749	.170	1.191	.393	1.880	.547	.438	.562	1.781
12	1.046	.812	.264	1.191	.450	1.965	.625	.516	.688	1.843
14	1.171	.905	.310	1.254	.519	2.113	.734	.625	.781	1.953
16	1.297	1.030	.330	1.316	.583	2.315	.750	.656	.890	2.000
18	1.422	1.015	.444	1.562	.621	2.423	.781	.703	1.000	2.046
20	1.562	1.077	.510	1.625	.683	2.695	.859	.766	1.125	2.218
22	1.672	1.139	.515	1.719	.739	2.742	.906	.812	1.234	2.265
24	1.797	1.265	.656	1.751	.797	2.980	1.169	.918	1.374	2.624

All dimensions for reference only.



# PT Connectors with Printed Circuit Board Contacts

## Box Mounting Receptacle (PT02) with PCB Contacts

Order by applicable part number in chart below; add insert arrangement number. Refer to insert availability on pages 4-10.

- (MMC) located within .0025 of (TP)

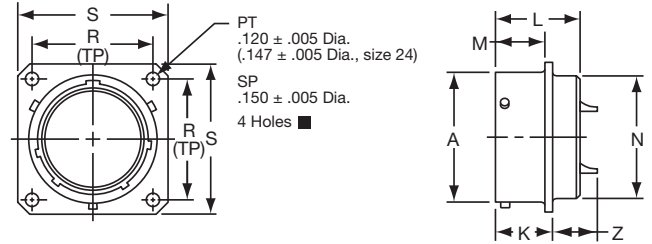

Shell Size	Part Number* PT02 with PCB Contacts	Receptacle Front View				Receptacle Side View				
		R (TP)	S +.011 -.010	A +.001 -.005	K +.021 -.010	L Max.	M +.031 -.000	N Dia. Max.	Z +.040 -.050	
6	71-570120-XXX	.469	.688	.348	.493	.825	.431	.323	.380	
8	71-570121-XXX	.594	.812	.473	.493	.825	.431	.449	.380	
10	71-570122-XXX	.719	.938	.590	.493	.825	.431	.573	.380	
12	71-570123-XXX	.812	1.031	.750	.493	.825	.431	.699	.380	
14	71-570124-XXX	.906	1.125	.875	.493	.825	.431	.823	.380	
16	71-570125-XXX	.969	1.219	1.000	.493	.825	.431	.949	.380	
18	71-570126-XXX	1.062	1.312	1.125	.493	.825	.431	1.073	.380	
20	71-570127-XXX	1.156	1.438	1.250	.650	1.076	.556	1.199	.286	
22	71-570128-XXX	1.250	1.562	1.375	.650	1.076	.556	1.323	.286	
24	71-570129-XXX	1.375	1.688	1.500	.683	1.109	.589	1.449	.253	

All dimensions for reference only.

## Jam Nut Receptacle (PT07) with PCB Contacts

All lockwire holes are .044 Dia. Min.

Order by applicable part number in chart below; add insert arrangement number. Refer to insert availability on pages 4-10.

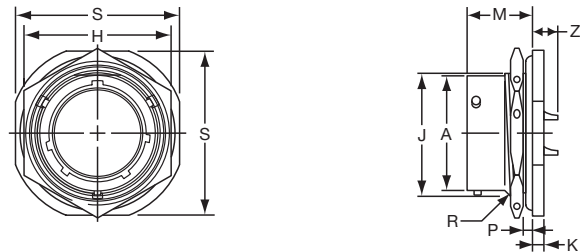

Shell Size	Part Number* PT02 with PCB Contacts	Receptacle Front View				Receptacle Side View						
		H +.017 -.016	S ±.010	A Dia. +.001 -.005	J Flat +.000 -.010	K +.011 -.010	M ±.010	P Panel Thickness		R Thread Class 2A	Z +.025 -.035	
							Min.	Max.				
6	71-533720-XXX	.625	.812	.348	.405	.125	.696	.062	.125	.4375-28 UNEF	.376	
8	71-533721-XXX	.750	.938	.473	.530	.125	.696	.062	.125	.5625-24 UNEF	.376	
10	71-533722-XXX	.875	1.062	.590	.655	.125	.696	.062	.125	.6875-24 UNEF	.376	
12	71-533723-XXX	1.062	1.250	.750	.818	.125	.696	.062	.125	.8750-20 UNEF	.376	
14	71-533724-XXX	1.188	1.375	.875	.942	.125	.696	.062	.125	1.0000-20 UNEF	.376	
16	71-533725-XXX	1.312	1.500	1.000	1.066	.125	.696	.062	.125	1.1250-18 UNEF	.376	
18	71-533726-XXX	1.438	1.625	1.125	1.191	.125	.696	.062	.125	1.2500-18 UNEF	.376	
20	71-533727-XXX	1.562	1.812	1.250	1.316	.156	.884	.062	.250	1.3750-18 UNEF	.367	
22	71-533728-XXX	1.688	1.938	1.375	1.441	.156	.884	.062	.250	1.5000-18 UNEF	.367	
24	71-533729-XXX	1.816	2.062	1.500	1.556	.156	.917	.062	.250	1.6250-18 UNEF	.334	

All dimensions for reference only.

\* For RoHS compliance connectors with PCB contacts change "71"- to:  
 "FL" designates conductive gray zinc nickel plating  
 "93" designates black zinc cobalt plating

# PTB SPB thru bulkhead receptacle

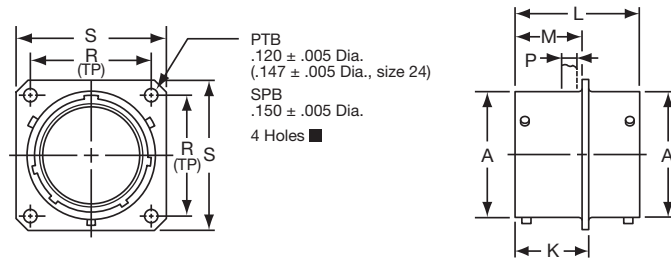

\* PTB-XX-XXX  
\* SPB-XX-XXX

\* To complete part number add desired arrangement number (refer to pages 4 and 5 for insert availability) and add "PS";  
Example: PTB-18-32PS. If a rotation is required, use PTB-18-32PS and add W, X, Y or Z. Example: PTB-18-32 PSW.

The socket end of the insert always appears at the "P" dimension end of shell.

■(MMC) located within .0025 of (TP)

Shell Size	Receptacle Front View				Receptacle Side View					
	R (TP)		S		A	K	L	M	P Max.	
	PTB	SPB	PTB	SPB	+0.001 -0.005	+0.016 -0.000	±.005	+0.010 -0.000	PTB	SPB
6	.469	.641	.688	.953	.348	.625	1.050	.562	.125	.188
8	.594	.734	.812	1.047	.473	.625	1.050	.562	.125	.188
10	.719	.812	.938	1.125	.590	.625	1.050	.562	.125	.188
12	.812	.938	1.031	1.250	.750	.625	1.050	.562	.125	.188
14	.906	1.031	1.125	1.344	.875	.625	1.050	.562	.125	.188
16	.969	1.125	1.219	1.438	1.000	.625	1.050	.562	.125	.188
18	1.062	1.203	1.312	1.516	1.125	.625	1.050	.562	.125	.188
20	1.156	1.297	1.438	1.672	1.250	.781	1.330	.688	.125	.312
22	1.250	1.375	1.562	1.750	1.375	.781	1.330	.688	.125	.312
24	1.375	1.500	1.688	1.875	1.500	.781	1.330	.688	.125	.312

All dimensions for reference only.

# PT hermetic

solder  
mounting  
receptacle

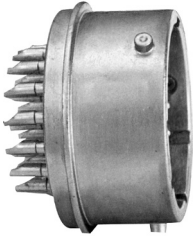

box mounting  
receptacle

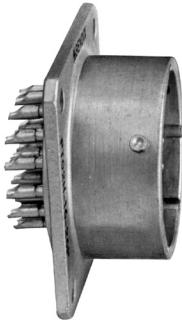

jam nut  
receptacle



## Three shell styles are available in the hermetic PT bayonet series:

- PTIH (MS3113H)
- PT02H
- PT07H (MS3114H)

These hermetic connectors are only available with solder cup or flat eyelet pin contacts in the MS/PT version. Socket contacts are available in some proprietary PT versions. Other design characteristics of the PT hermetic connector series are as follows:

Shell sizes: 8 through 24 (tin plated)

Contact count: 2 through 61. Refer to pages 4 and 5 for insert availability for hermetics.

Current: 5.0 amp each #20 contact  
10 amp each #16 contact  
17 amp each #12 contact

Contacts are tin plated for PT; gold is optional

Dielectric Withstanding Voltage (sea level):  
1500 volts (RMS) 60 cps, Service Rating I  
2300 volts (RMS) 60 cps, Service Rating II

Compression glass inserts, permanently lettered

Helium Leakage: Less than  $1.0 \times 10^{-6}$  cc/sec.  
at 15 psi differential

Physical Shock: 100 G's

Vibration: Exceeds MIL-E-5272 Procedure II

Thermal Shock: No deterioration or failure after 5 cycles  
at -55°F to +257°F

Intermateability: Mates with MS3116 and PT06

Refer to pages 4-10 for insert arrangement availability.

# PTIH (MS3113H)

## hermetic solder mounting receptacle

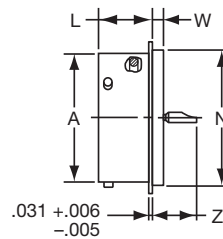
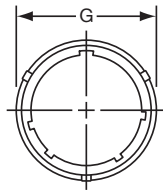

- \* PTIH-XX-XXX
- \*\* PTIY-XX-XXX
- \*\* MS3113H-XXCXXX
- † PTIH-XX-XXX (100)
- †† PTIY-XX-XXX (100)
- †† MS3113H-XXYXXX

To complete part number see how to order on page 25.

\* Solder cup pin contacts without interfacial seal

\*\* Solder cup pin contacts with interfacial seal

† Flat eyelet pin contacts without interfacial seal

†† Flat eyelet pin contacts with interfacial seal

Shell Size	Recept. Front View	Receptacle Side View				
	G Dia. Max.	A Dia. +.001 - .005	L +.025 - .016	N Dia. +.001 - .005	W +.001 - .010	Z Max.
6	.511	.348	.447	.438	.094	.386
8	.636	.473	.447	.562	.094	.386
10	.761	.590	.447	.672	.094	.386
12	.855	.750	.447	.781	.094	.386
14	.980	.875	.447	.906	.094	.386
16	1.105	1.000	.447	1.031	.094	.386
18	1.229	1.125	.447	1.156	.094	.386
20	1.323	1.250	.509	1.250	.094	.386
22	1.449	1.375	.509	1.375	.125	.418
24	1.574	1.500	.542	1.500	.125	.418

All dimensions for reference only.

# PT02H

## hermetic box mounting receptacle

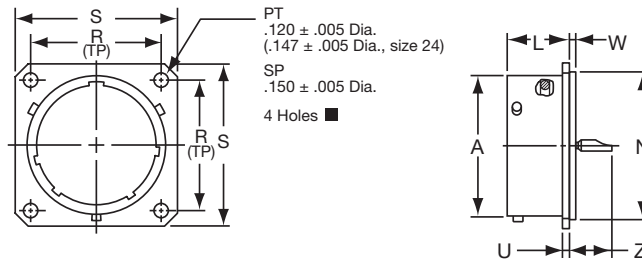

- \* PT02H-XX-XXX
- \*\* PT02Y-XX-XXX
- † PT02H-XX-XXX (100)
- †† PT02Y-XX-XXX (100)

To complete part number see how to order on page 25.

\* Solder cup pin contacts without interfacial seal

\*\* Solder cup pin contacts with interfacial seal

† Flat eyelet pin contacts without interfacial seal

†† Flat eyelet pin contacts with interfacial seal

■ (MMC) located within .0025 of (TP)

Shell Size	Recept. Front View		Receptacle Side View					
	R (TP)	S ±.016	A Dia. +.001 -0.005	K ±.015	L +.025 -0.015	N Dia. +.001 -0.005	U +.011 -0.010	Z Max.
6	.469	.688	.348	.047	.494	.438	.062	.344
8	.594	.812	.473	.047	.494	.562	.062	.344
10	.719	.938	.590	.047	.494	.672	.062	.344
12	.812	1.031	.750	.047	.494	.781	.062	.344
14	.906	1.125	.875	.047	.494	.906	.062	.344
16	.969	1.219	1.000	.047	.494	1.031	.062	.344
18	1.062	1.312	1.125	.047	.494	1.156	.062	.344
20	1.156	1.438	1.250	.047	.556	1.250	.062	.344
22	1.250	1.562	1.375	.079	.556	1.375	.062	.377
24	1.375	1.688	1.500	.079	.588	1.500	.062	.377

All dimensions for reference only.

# PT07H (MS3114H)

## hermetic jam nut receptacle

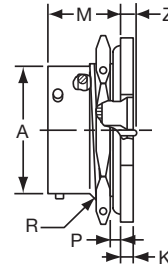
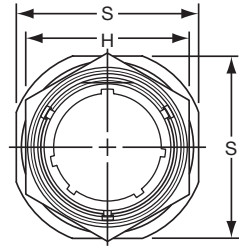

- \* PT07H-XX-XXX
- \*\* PT07Y-XX-XXX
- \*\* MS3114H-XXCXXX
- † PT07H-XX-XXX (100)
- †† PT07Y-XX-XXX (100)
- †† MS3114H-XXYXXX

To complete part number see how to order on page 25.

\* Solder cup pin contacts without interfacial seal

\*\* Solder cup pin contacts with interfacial seal

† Flat eyelet pin contacts without interfacial seal

†† Flat eyelet pin contacts with interfacial seal

Shell Size	Recept. Front View		Receptacle Side View						
	S ±.016	H Hex +.017 -.016	A +.001 -.005	K +.043 -.016	M +.031 -.000	P Panel Thickness		R Thread Class 2A	Z Max.
						Max.	Min.		
6	.812	.625	.348	.094	.696	.125	.062	.4375-28 UNEF	.206
8	.938	.750	.473	.094	.696	.125	.062	.5625-24 NEF	.206
10	1.062	.875	.590	.094	.696	.125	.062	.6875-24 NEF	.206
12	1.250	1.062	.750	.094	.696	.125	.062	.8750-20 UNEF	.206
14	1.375	1.188	.875	.094	.696	.125	.062	1.0000-20 UNEF	.206
16	1.500	1.312	1.000	.094	.696	.125	.062	1.1250-18 NEF	.206
18	1.625	1.438	1.125	.094	.696	.125	.062	1.2500-18 NEF	.206
20	1.812	1.562	1.250	.125	.884	.250	.062	1.3750-18 NEF	.081
22	1.938	1.688	1.375	.125	.884	.250	.062	1.5000-18 NEF	.081
24	2.062	1.812	1.500	.125	.917	.250	.062	1.6250-18 NEF	.048

All dimensions for reference only.



# PT, SP, MS/PT

## how to order

### PT,SP

Ex: PT00A-20-41PW003

1.	2.	3.	4.	5.	6.	7.	8.
Connector Type	Shell Style	Service Class	Shell Size	Insert Arrangement	Contact Configuration	Insert Rotation	Finish
PT	00	A	20	41	P	W	003

#### 1. Connector Type

<b>PT</b>	standard olive drab, electrically conductive cadmium plate bayonet lock connector with solder contacts
<b>SP</b>	electrically non-conductive, hard anodic coated bayonet lock connector with solder contacts and larger flange and mounting holes for back panel mounting
<b>PTG</b>	plug with grounding fingers

#### 2. Shell Style

<b>00</b>	Wall mounting receptacle
<b>01</b>	Cable connecting receptacle
<b>02</b>	Box mounting receptacle
<b>06</b>	Straight plug
<b>07</b>	Jam nut receptacle
<b>08</b>	90 degree plug cable support
<b>B</b>	thru bulkhead receptacle (pressurized)
<b>I</b>	Solder mount receptacle (Hermetic only)

#### 3. Service Class

<b>A</b>	General duty back shell
<b>C</b>	Pressurized receptacle
<b>E</b>	Environmental resisting open wire seal with grommet and nut
<b>P</b>	Assembly with potting boot
<b>PG</b>	Adapter for cable glad for moisture proofing jacketed cables
<b>H</b>	Hermetic* without interfacial seal
<b>Y</b>	Hermetic* with interfacial seal

#### 4. Shell Size

Shell sizes 6 - 24 available

#### 5. Insert Arrangement

Refer to pages 4-10 for insert availability (Use only the number following the hyphen)

#### 6. Contact Configuration

<b>P</b>	Pin contacts
<b>S</b>	Socket contacts

For ordering connectors with printed circuit board contacts, see pg. 19.

#### 7. Insert Rotation

No letter is required for normal position

<b>W</b>	Refer to page 6
<b>X</b>	
<b>Y</b>	
<b>Z</b>	

#### 8. Finish

**SR** Designates a strain relief clamp

Indicate optional finishes as follows:

<b>100</b>	Suffix added for flat eyelet pin contacts in hermetic versions
------------	--

**OR**

<b>005</b>	* Anodic coating - Alumilite® (standard on "SP")
<b>023</b>	* Electroless nickel
<b>025</b>	Black zinc cobalt plating
<b>072</b>	* Conductive gray zinc nickel plating
<b>424</b>	* Electroless nickel finish with strain relief
<b>470</b>	Black zinc cobalt plating with strain relief
<b>725</b>	Gray zinc nickel plating with strain relief

\* RoHS Compliant finish

**Note:** Olive drab cadmium is the default plating. If required on SP type use suffix (003).

### MS/PT

**MIL-DTL-26482, Series 1**

Ex: MS3110E20-41PW

1.	2.	3.	4.	5.	6.	7.	8.
Connector Type	Specification Number	Shell Style	Service Class	Shell Size	Insert Arrangement	Contact Configuration	Insert Rotation
MS	311	0	E	20	41	P	W

#### 1. Connector Type

<b>MS</b>	Military standard
-----------	-------------------

#### 2. Specification Number

<b>311</b>	Basic family number for MIL-DTL-26482, Series 1 solder type
------------	---

#### 3. Shell Style

<b>0</b>	Wall mounting receptacle
<b>1</b>	Cable connecting receptacle
<b>2</b>	Box mounting receptacle
<b>3</b>	Solder mount receptacle (Hermetic only)
<b>4</b>	Jam nut receptacle
<b>6</b>	Straight plug

#### 4. Service Class

<b>E</b>	Environmental resisting connector
<b>F</b>	Environmental resisting connectors with strain relief
<b>J</b>	Clamp assembly for moisture proofing multi-jacketed cables, with strain relief
<b>P</b>	Potted type with potting boot
<b>H</b>	Hermetic

#### 5. Shell Size

Shell sizes 8 - 24 available

#### 6. Insert Arrangement

Refer to pages 4-10 for insert availability (Use only the number following the hyphen)

#### Hermetic Version:

In this version a letter replaces the hyphen between the Shell Size and Insert Arrangement (Steps 5 and 6)

<b>Y</b>	Flat eyelet pin contacts
<b>C</b>	Solder cup pin contacts

#### 7. Contact Configuration

<b>P</b>	Pin contacts
<b>S</b>	Socket contacts

For ordering connectors with printed circuit board contacts, see pg. 19.

#### 8. Insert Rotation

No letter is required for normal position

<b>W</b>	Refer to page 6
<b>X</b>	
<b>Y</b>	
<b>Z</b>	

\* Hermetic connectors are supplied with tin plated shells.

\*\* This connector style is sometimes referred to as a cable connecting "plug". It does, however, mate with either a straight or 90 degree plug.

# Amphenol PT-SE, SP-SE, MS/PT-SE

Proprietary/MIL-DTL-26482, Series 1  
bayonet coupling and crimp termination

wall mounting  
receptacle



**Amphenol® SE crimp type miniature connectors provide performance and versatility needed for applications demanding high reliability and crimp removable contacts. These crimp contacts are rear insertable/front release and are held in position by an MS approved spring tower retention system.**

The MS/PT-SE Series is qualified to MIL-DTL-26482, Series 1 and has all the outstanding design characteristics and quality of the PT Series.

cable  
connecting  
receptacle\*



The SP-SE Series is a modification of the PT-SE, providing special shells with a wide mounting flange for back panel mounting.

A corrosion resistant electrically conductive finish of cadmium plate with an olive drab chromate after-treatment is used on the PT-SE and MS/PT-SE. The SP-SE is given a durable non-conductive hard anodic "Alumilite"® coating which provides abrasion protection and resistance to corrosion.

box mounting  
receptacle



500 hour corrosion resistance, RoHS compliant harsh environment conductive plating. Gray Zinc over an Electroless Nickel (Gray ZnNi) base, with a Light Gun Metal Gray appearance.

Shell components for these series are aluminum. The dependable 5 key/keyway polarization with bayonet lock coupling assures positive mating with no chance of cross plugging. Spring tension provided by a wave washer in the coupling nut ensures maintenance of interfacial seal between mating halves.

straight plug



Both the insert and main joint gasket are molded from resilient neoprene. This provides excellent moisture sealing at the gasket and superior electrical isolation of the contact in the insert.

Both pins and sockets are machined from a copper alloy and are gold plated. This gold plating eliminates contact corrosion and offers an indefinite shelf life. Socket contacts for these series are closed entry design.

jam nut  
receptacle



Breakaway style plug is available in PT-SE crimp.

The PT-SE, SP-SE and MS/PT-SE Series are intermateable and intermountable with all existing Miniature Cylindrical Series connectors.

Refer to pages 4-10 for insert arrangement availability.

\* This connector style is sometimes referred to as a cable connecting "plug". It does, however, mate with either a straight or 90 degree plug.

# PT-SE, SP-SE, MS/PT-SE

Contact Specifications				
Contact Size	Test Current	Maximum Millivolt Drop†	Crimp Well Diameter	Minimum Well Depth
20	7.5	55	.049±.001	.267
16	13.0	49	.067±.001	.236
12	23.0	42	.100±.002	.236

Service Rating					
Service Rating	Recommended Operating AC Voltage at Sea Level	Test Voltage AC (RMS), 60 cps			
		Sea Level	50,000 ft.	70,000 ft.	110,000 ft.
I	600	1,500	500	375	200
II	1,000	2,300	750	500	200

† Silver plated wire per MIL-DTL-26482

“SE”,  
MS / “E”  
open wire seal



## PT-SE and SP-SE Service Classes

PT-SE and SP-SE connectors are available in the three service classes listed below.

- “SE” Open wire sealing - environmental resistant, with a nut and grommet for moisture proofing individual wires
- “SE (SR)” Strain relief clamp - environmental resistant strain relief clamp and grommet for moisture proofing individual wires; provides added wire bundle support
- “SP” Translucent nylon boot for retaining customer applied potting compounds; held in place by a threaded ring

“SE” (SR),  
MS / “F”  
strain relief  
clamp



## MS/PT-SE Service Classes

MS-SE series connectors are available in the following certified service classes:

- “E” Open wire sealing - environmental resisting connectors are supplied with a multi-hole grommet and clamping nut for moisture proofing individual open wires
- “F” Environmental resistant strain relief clamp and grommet for moisture proofing individual wires; provides added wire bundle support
- “P” Potting applications - these connectors are supplied with a translucent nylon boot for retention of customer applied potting compound

“SP”,  
MS / “P”  
potting boot



# PT00 SE (MS3120)

## SPO0 SE

### wall mounting receptacle

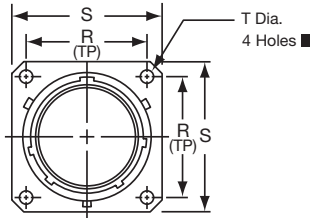

"SE" Open Wire Seal

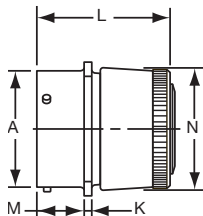

PT00SE-XX-XXX  
SPO0SE-XX-XXX  
MS3120E-XX-XXX

#### TERMINATION ASSEMBLIES

"SE" (SR), MS / "F" Strain Relief

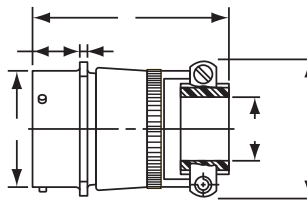

PT00SE-XX-XXX (SR)  
SPO0SE-XX-XXX (SR)  
MS3120F-XX-XXX

"SP" Potting Boot

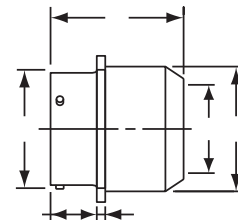

PT00SP-XX-XXX  
SPO0SP-XX-XXX

To complete part number see how to order on page 36.

•(MMC) located within .005 of (TP)

Shell Size	Receptacle Front View						Receptacle Side View					
	R (TP)		S Max.		T Dia. ±.005		A Dia. +.001 -.005	K ±.016	M +.010 -.000		P* Panel Thickness	
	PT	SP	PT	SP	PT	SP			PT	SP	PT	SP
8	.594	-	.828	-	.120	-	.473	.062	.431	-	.094	-
10	.719	.812	.954	1.141	.120	.150	.590	.062	.431	.462	.094	.125
12	.812	.938	1.047	1.226	.120	.150	.750	.062	.431	.462	.094	.125
14	.906	1.031	1.141	1.360	.120	.150	.875	.062	.431	.462	.094	.125
16	.969	1.125	1.234	1.453	.120	.150	1.000	.062	.431	.462	.094	.125
18	1.062	1.203	1.328	1.532	.120	.150	1.125	.062	.431	.462	.094	.125
20	1.156	1.297	1.453	1.688	.120	.150	1.250	.094	.556	.556	.219	.219
22	1.250	1.375	1.578	1.766	.120	.150	1.375	.094	.556	.556	.219	.219
24	1.375	1.500	1.703	1.891	.147	.150	1.500	.094	.589	.589	.219	.219

Shell Size	Class "SE", MS/"E"		Class "SE"(SR), MS/"F"			Class "SP", MS/"P"		
	L Max.	N Dia. Max	G Dia.	L Max.	N Max.	D Dia. Max.	L Max.	N Dia. Max.
8	1.328	.560	.125	2.422	.781	-	-	-
10	1.328	.704	.188	2.422	.844	.444	1.656	.734
12	1.328	.825	.312	2.422	.969	.558	1.656	.858
14	1.328	.954	.375	2.422	1.094	.683	1.656	.984
16	1.328	1.080	.500	2.537	1.156	.808	1.656	1.110
18	1.328	1.204	.625	2.537	1.406	.909	1.656	1.234
20	1.359	1.330	.625	2.824	1.406	1.034	1.750	1.360
22	1.359	1.454	.750	2.824	1.594	1.159	1.750	1.484
24	1.422	1.580	.800	2.900	1.688	1.284	1.782	1.610

\* Back panel mounting  
All dimensions for reference only.

# MF00 SE (MS3128)

## wall mounting receptacle

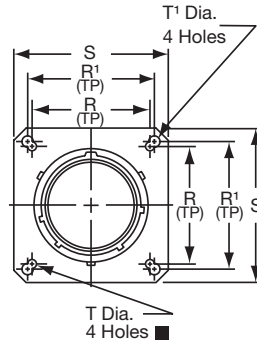

"SE" Open Wire Seal

### TERMINATION ASSEMBLIES

MS / "F" Strain Relief

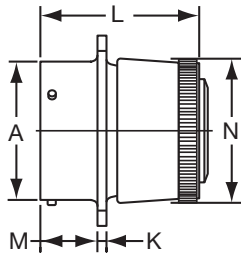

MF00SE-XX-XXX  
MS3128E-XX-XXX

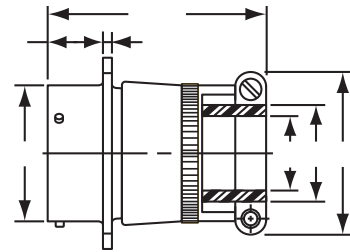

MF00SE-XX-XXX (SR)  
MS3128F-XX-XXX

Shell Size	Receptacle Front View					Receptacle Side View								
	R	R <sup>1</sup>	S Max.	T Dia. ±.005	T <sup>1</sup> Dia. ±.005	A Dia. +.001 -.000	K ±.016	M +.010 -.000	Class MS/ "E"		Class MS/ "F"			
									L Max.	N Max.	F Min.	G Dia.	L Max.	N Max.
10	.719	.812	1.141	.120	.150	.590	.062	.462	1.328	.685	.297	.188	1.906	.891
12	.812	.938	1.266	.120	.150	.750	.062	.462	1.328	.813	.422	.312	1.906	1.016
14	.906	1.031	1.360	.120	.150	.875	.062	.462	1.328	.930	.547	.375	1.906	1.141
16	.969	1.125	1.453	.120	.150	1.000	.062	.462	1.328	1.057	.609	.500	2.000	1.203
18	1.062	1.203	1.532	.120	.150	1.125	.062	.462	1.28	1.175	.734	.625	2.000	1.469
20	1.156	1.297	1.688	.120	.150	1.250	.094	.556	1.359	1.301	.734	.625	2.172	1.469
22	1.250	1.375	1.766	.120	.150	1.375	.094	.556	1.359	1.428	.922	.750	2.172	1.656
24	1.375	1.500	1.891	.147	.150	1.500	.094	.589	1.422	1.533	.984	.800	2.234	1.750

All dimensions for reference only.

# PT01 SE (MS3121)

## SP01 SE

cable connecting receptacle

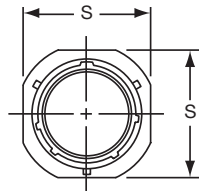

### TERMINATION ASSEMBLIES

"SE" Open Wire Seal

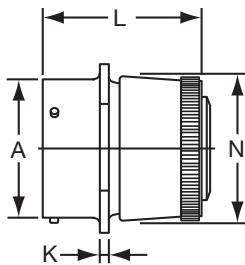

PT01SE-XX-XXX  
SP01SE-XX-XXX  
MS3121E-XX-XXX

"SE" (SR), MS / "F" Strain Relief

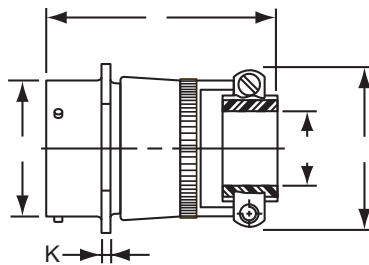

PT01SE-XX-XXX (SR)  
SP01SE-XX-XXX (SR)  
MS3121F-XX-XXX

"SP", MS / "P" Potting Boot

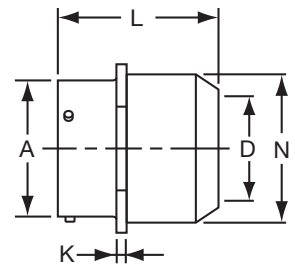

PT01SP-XX-XXX  
SP01SP-XX-XXX  
MS3121P-XX-XXX

Note: This connector style is sometimes referred to as a cable connecting "plug".

It does, however, mate with either a straight or 90 degree plug.

To complete part number see how to order on page 36.

Shell Size	Receptacle Front View		Receptacle Side View									
	S Max.	A Dia. +.001 -.005	Class "SE", MS/ "E"				Class "SE" (SR), MS/"F"			Class "SP", MS/"P"		
			K ±.018	L Max.	N Dia. Max.	G Dia.	L Max.	N Max.	D Dia.	L Max.	N Dia. Max.	
8	.832	.473	.094	1.522	.560	.125	2.422	.828	-	-	-	
10	.975	.590	.094	1.522	.685	.188	2.422	.891	.444	1.656	.734	
12	1.068	.750	.094	1.522	.813	.312	2.422	1.016	.558	1.656	.858	
14	1.162	.875	.094	1.522	.930	.375	2.422	1.141	.683	1.656	.984	
16	1.256	1.000	.094	1.522	1.057	.500	2.537	1.203	.808	1.656	1.110	
18	1.349	1.125	.094	1.522	1.175	.625	2.537	1.469	.909	1.656	1.234	
20	1.475	1.250	.115	1.709	1.301	.625	2.824	1.469	1.034	1.750	1.360	
22	1.599	1.375	.115	1.709	1.428	.750	2.824	1.656	1.159	1.750	1.484	
24	1.729	1.500	.115	1.709	1.555	.800	2.900	1.750	1.284	1.782	1.610	

All dimensions for reference only.

# PT02 SE (MS3122)

## SPO2 SE

### box mounting receptacle

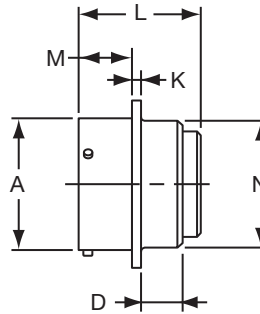
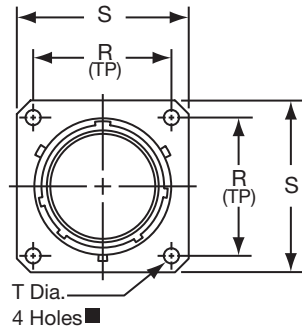

PT02SE-XX-XXX  
 SPO2SE-XX-XXX  
 MS3122E-XX-XXX

To complete part number see how to order on page 36.

■ (MMC) located within .0025 of (TP)

Shell Size	Receptacle Front View						Receptacle Side View							
	R		S Max.		T Dia. ±.005		A Dia. +.001 -.005	D Max.		K ±.025	L Max.	M +.010 -.000		N Dia. +.011 -.000
	PT	SP	PT	SP	PT	SP	PT	SP	PT			SP		
8	.594	-	.828	-	.120	-	.473	.312	-	.062	1.358	.431	-	.438
10	.719	.812	.954	1.141	.120	.150	.590	.312	.219	.062	1.296	.431	.462	.562
12	.812	.938	1.047	1.266	.120	.150	.750	.312	.219	.062	1.296	.431	.462	.688
14	.906	1.031	1.141	1.360	.120	.150	.875	.312	.219	.062	1.296	.431	.462	.812
16	.969	1.125	1.234	1.453	.120	.150	1.000	.312	.219	.062	1.296	.431	.462	.938
18	1.062	1.203	1.328	1.532	.120	.150	1.125	.312	.219	.062	1.296	.431	.462	1.062
20	1.156	1.297	1.453	1.688	.120	.150	1.250	.406	.344	.094	1.358	.556	.556	1.188
22	1.250	1.375	1.578	1.766	.120	.150	1.375	.406	.344	.094	1.358	.556	.556	1.312
24	1.375	1.500	1.703	1.891	.147	.150	1.500	.406	.344	.094	1.358	.589	.589	1.438

All dimensions for reference only.

# MF02 SE (MS3127)

## box mounting receptacle

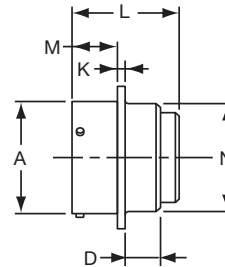
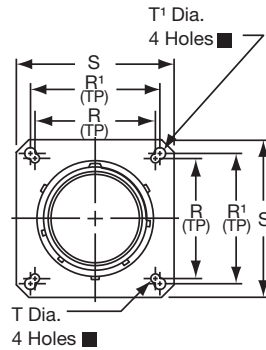

MF02SE-XX-XXX  
MS3127E-XX-XXX

To complete part number see how to order on page 36.

■ (MMC) located within .0025 of (TP)

Shell Size	Receptacle Front View						Receptacle Side View				
	N Dia. +.011 -0.000	R	R <sup>1</sup>	S Max.	T ±.005	T <sup>1</sup> ±.005	A Dia. +.001 -0.005	D Max.	K ±.016	L Max.	M +.010 -0.000
10	.562	.719	.812	1.141	.120	.150	.590	.219	.062	1.266	.462
12	.688	.812	.938	1.266	.120	.150	.750	.219	.062	1.266	.462
14	.812	.906	1.031	1.360	.120	.150	.875	.219	.062	1.266	.462
16	.938	.969	1.125	1.453	.120	.150	1.000	.219	.062	1.266	.462
18	1.062	1.062	1.203	1.532	.120	.150	1.125	.219	.062	1.266	.462
20	1.188	1.156	1.297	1.688	.120	.150	1.250	.344	.094	1.328	.556
22	1.312	1.250	1.375	1.766	.120	.150	1.375	.344	.094	1.328	.556
24	1.438	1.375	1.500	1.891	.147	.150	1.500	.344	.094	1.328	.589

All dimensions for reference only.



# PT06 SE (MS3126)

## SP06 SE

straight plug

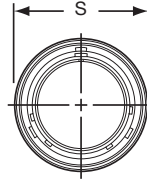

“SE”, MS / “E” Open Wire Seal

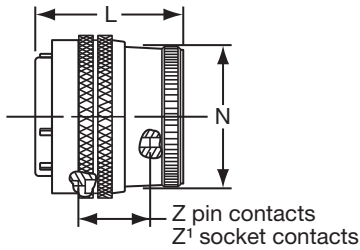

PT06SE-XX-XXX  
 SP06SE-XX-XXX  
 PTG06SE-XX-XXX  
 MS3126E-XX-XXX

### TERMINATION ASSEMBLIES

“SE” (SR), MS / “F” Strain Relief

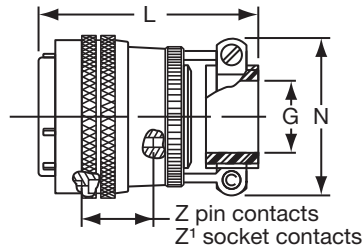

PT06SE-XX-XXX (SR)  
 SP06SE-XX-XXX (SR)  
 PTG06SE-XX-XXX (SR)  
 MS3126F-XX-XXX

“SP”, MS / “P” Potting Boot

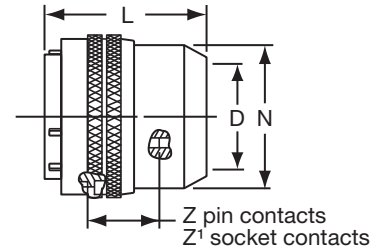

PT06SP-XX-XXX  
 SP06SP-XX-XXX  
 PTG06SP-XX-XXX  
 MS3126P-XX-XXX

To complete part number see how to order on page 36.

Shell Size	Plug Front View			Plug Side View							
	S Dia. Max.	Z ±.045	Z' ±.045	Class “SE”, MS/“E”		Class “SE” (SR), MS/“F”			Class “SP”, MS/“P”		
				L Max.	N Max.	G Dia.	L Max.	N Max.	D Dia.	L Max.	N Dia. Max.
8*	.734	.640	.579	1.328	.540	.125	2.413	.828	.327	1.750	.578
10	.859	.640	.579	1.328	.685	.188	2.413	.891	.444	1.750	.734
12	1.031	.640	.579	1.328	.813	.312	2.413	1.016	.558	1.750	.858
14	1.156	.640	.579	1.328	.930	.375	2.413	1.141	.683	1.750	.984
16	1.281	.640	.579	1.328	1.057	.500	2.528	1.203	.808	1.750	1.110
18	1.391	.640	.579	1.328	1.175	.625	2.528	1.469	.909	1.750	1.234
20	1.531	.640	.579	1.297	1.301	.625	2.753	1.469	1.034	1.750	1.360
22	1.656	.640	.579	1.297	1.428	.750	2.753	1.656	1.159	1.750	1.484
24	1.777	.640	.579	1.359	1.533	.800	2.830	1.750	1.284	1.766	1.610

\* PT-SE, MS-SE and MS-SP only.  
 All dimensions for reference only.

# PT07 SE (MS3124)

## SP07 SE

jam nut receptacle

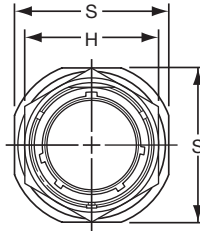

"SE", MS / "E" Open Wire Seal

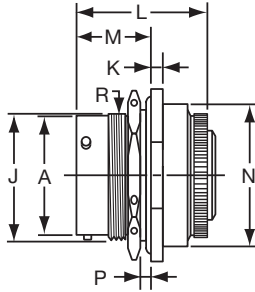

PT07SE-XX-XXX  
SP07SE-XX-XXX  
MS3124E-XX-XXX

**TERMINATION ASSEMBLIES**  
"SE" (SR), MS / "F" Strain Relief

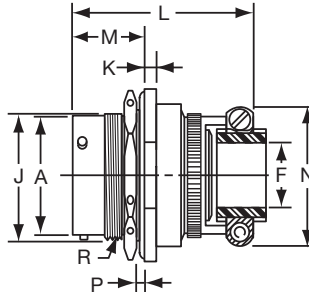

PT07SE-XX-XXX (SR)  
SP07SE-XX-XXX (SR)  
MS3124F-XX-XXX

"SP", MS / "P" Potting Boot

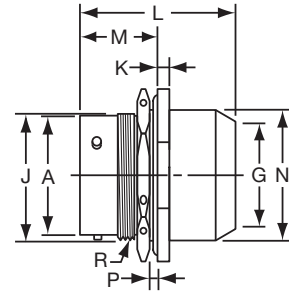

PT07SP-XX-XXX  
SP07SP-XX-XXX  
MS3124P-XX-XXX

To complete part number see how to order on page 36.  
All lockwire holes are .044 Dia. Min.

Shell Size	Receptacle Front View		Receptacle Side View						
	H Hex Max.	S Max.	A Dia. +.001 -0.005	J Flat +.000 -.010	K +.011 -.010	M ±.005	P Panel Thickness		R Thread Class 2A
							Min.	Max.	
8	.767	.954	.473	.530	.125	.696	.062	.125	.5625-24 UNEF
10	.892	1.078	.590	.655	.125	.696	.062	.125	.6875-24 NEF
12	1.079	1.266	.750	.818	.125	.696	.062	.125	.8750-20 UNEF
14	1.205	1.391	.875	.942	.125	.696	.062	.125	1.0000-20 UNEF
16	1.329	1.516	1.000	1.066	.125	.696	.062	.125	1.1250-18 NEF
18	1.455	1.641	1.125	1.191	.125	.696	.062	.125	1.2500-18 NEF
20	1.579	1.828	1.250	1.316	.156	.884	.062	.250	1.3750-18 NEF
22	1.705	1.954	1.375	1.441	.156	.884	.062	.250	1.5000-18 NEF
24	1.829	2.078	1.500	1.556	.156	.917	.062	.250	1.6250-18 NEF

Shell Size	Class "SE", MS/"E"		Class "SE" (SR), MS/"F"				Class "SP", MS/"P"		
	L Max.	N Max.	F Min.	G Dia. Free	L Max.	N Max.	G Dia.	L Max.	N Dia. Max.
8	1.438	.749	.234	.125	1.922	.828	-	-	-
10	1.438	.874	.297	.188	1.922	.891	.444	1.656	.734
12	1.438	.999	.422	.312	1.922	1.016	.558	1.656	.858
14	1.438	1.124	.547	.375	1.922	1.141	.683	1.656	.984
16	1.438	1.249	.609	.500	2.000	1.203	.808	1.656	1.110
18	1.438	1.374	.734	.625	2.000	1.469	.909	1.656	1.234
20	1.625	1.530	.734	.625	2.172	1.469	1.034	1.922	1.360
22	1.625	1.655	.922	.750	2.172	1.656	1.159	1.922	1.484
24	1.688	1.780	.984	.800	2..234	1.750	1.284	1.951	1.610

All dimensions for reference only.

# PT08 SE

# SP08 SE

## 90 degree plug

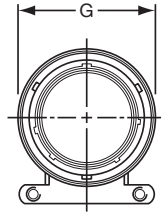

"SE" Open Wire Seal, "SE" (SR) Strain Relief

### TERMINATION ASSEMBLIES

"SP" Potting Boot 75 degrees

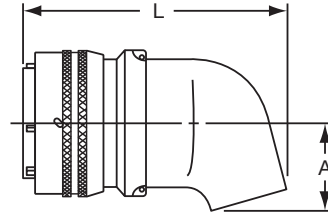
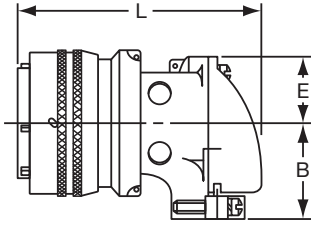

PT08SE-XX-XXX  
 SP08SE-XX-XXX  
 PT08SE-XX-XXX (SR)  
 SP08SE-XX-XXX (SR)

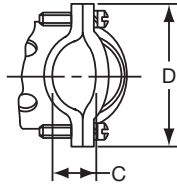

PT08SP-XX-XXX  
 SP08SP-XX-XXX

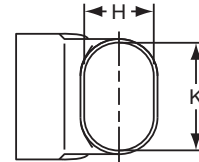

To complete part number see how to order on page 36.  
 All lockwire holes are .044 Dia. Min.

Shell Size	Plug Front View			Plug Side View						
	G Dia. Max.	B ±.031	C +.010 -.025	D ±.062	E +.047 -.025	L Max.	A ±.025	H ±.015	K ±.015	L Max.
10	.921	.749	.170	1.191	.393	2.137	.547	.438	.562	2.031
12	1.046	.812	.264	1.191	.450	2.222	.625	.516	.688	2.093
14	1.171	.905	.310	1.254	.519	2.370	.734	.625	.781	2.203
16	1.297	1.030	.330	1.316	.583	2.572	.750	.656	.890	2.250
18	1.422	1.015	.444	1.562	.621	2.680	.781	.703	1.000	2.296
20	1.562	1.077	.510	1.625	.683	2.753	.859	.766	1.125	2.343
22	1.672	1.139	.515	1.719	.739	2.799	.906	.812	1.234	2.390
24	1.797	1.250	.656	1.750	.787	3.037	1.181	.918	1.374	2.624

All dimensions for reference only.

# PT-SE, SP-SE, MS/PT-SE

## how to order

### PT-SE, SP-SE

Ex: PT00SE-20-41PW003

1.	2.	3.	4.	5.	6.	7.	8.
Connector Type	Shell Style	Service Class	Shell Size	Insert Arrangement	Contact Configuration	Insert Rotation	Finish
PT	00	SE	20	41	P	W	003

1. Connector Type	
<b>PT</b>	standard olive drab, electrically conductive cadmium plate bayonet lock connector with solder contacts
<b>MF</b>	standard olive drab, electrically conductive cadmium plated, bayonet lock connector with dual mounting holes, and crimp contacts
<b>SP</b>	electrically non-conductive, hard anodic coated bayonet lock connector with solder contacts and larger flange and mounting holes for back panel mounting

2. Shell Style	
<b>00</b>	Wall mounting receptacle
<b>01</b>	Cable connecting receptacle
<b>02</b>	Box mounting receptacle
<b>06</b>	Straight plug
<b>07</b>	Jam nut receptacle
<b>08</b>	90 degree plug

3. Service Class	
<b>SE</b>	Environmental crimp
<b>SP</b>	potted type crimp
Both of the above are Amphenol proprietary versions of the MILDTL-26482, Series 1 crimp contact connector and offer 15 lbs. contact retention for size 20 contacts; 25 lbs. for size 16 contacts.	
<b>PG</b>	adapter for cable gland for moisture proofing jacketed cables
<b>SQ</b>	Braided shield termination
<b>G</b>	Heatshrink termination

4. Shell Size	
Shell sizes 8 - 24 available	

5. Insert Arrangement	
Refer to pages 4-10 for insert availability (Use only the number following the hyphen)	

6. Contact Configuration	
<b>P</b>	Pin contacts
<b>S</b>	Socket contacts

7. Insert Rotation	
No letter is required for normal position	
<b>W</b>	Refer to page 6
<b>X</b>	
<b>Y</b>	
<b>Z</b>	

8. Finish	
<b>SR</b>	Designates a strain relief clamp
Indicate optional finishes as follows:	
<b>100</b>	Suffix added for flat eyelet pin contacts in hermetic versions
<b>OR</b>	
<b>005</b>	* Anodic coating - Alumilite® (standard on "SP")
<b>023</b>	* Electroless nickel
<b>025</b>	Black zinc cobalt plating
<b>072</b>	* Conductive gray zinc nickel plating
<b>424</b>	* Electroless nickel finish with strain relief
<b>470</b>	Black zinc cobalt plating with strain relief
<b>725</b>	Gray zinc nickel plating with strain relief

\* RoHS Compliant finish

**Note:** Olive drab cadmium is the default plating. If required on SP type use suffix (003).

### MS/PT-SE

MIL-DTL-26482, Series 1

Ex: MS3120E20-41PW

1.	2.	3.	4.	5.	6.	7.	8.
Connector Type	Specification Number	Shell Style	Service Class	Shell Size	Insert Arrangement	Contact Configuration	Insert Rotation
MS	311	0	E	20	41	P	W

1. Connector Type	
<b>MS</b>	Military standard

2. Specification Number	
<b>312</b>	basic family for MIL-DTL-26482, Series 1 crimp type

3. Shell Style	
<b>0</b>	Wall mounting receptacle
<b>1</b>	Cable connecting receptacle*
<b>2</b>	Box mounting receptacle
<b>4</b>	Jam nut receptacle
<b>6</b>	Straight plug
<b>7</b>	box mounting receptacle with dual mounting holes
<b>8</b>	wall mounting receptacle with dual mounting holes

4. Service Class	
<b>E</b>	Environmental resisting connector
<b>F</b>	Environmental resisting connectors with strain relief
<b>P</b>	Potted type with potting boot
<b>SQ</b>	Braided shield termination
<b>G</b>	Heatshrink termination

5. Shell Size	
Shell sizes 8 - 24 available	

6. Insert Arrangement	
Refer to pages 4-10 for insert availability (Use only the number following the hyphen)	

7. Contact Configuration	
<b>P</b>	Pin contacts
<b>S</b>	Socket contacts

8. Insert Rotation	
No letter is required for normal position	
<b>W</b>	Refer to page 6
<b>X</b>	
<b>Y</b>	
<b>Z</b>	

\* This connector style is sometimes referred to as a cable connecting "plug". It does, however, mate with either a straight or 90 degree plug.

# PT & SP

accessories – sealing plugs, flange gaskets, potting boots

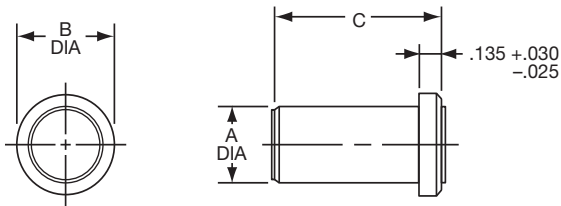

**SEALING PLUG**  
MS27488-XX  
10-405996-XX

## SEALING PLUGS- FOR PT & SP

Contact Size	Amphenol® Part Number	MS Number	A Dia. ±.010	B Dia. ±.005	C ±.010	Color Code
12	10-405996-12	MS27488-12	.121	.171	.564	Yellow
16	10-405996-16	MS27488-16	.083	.133	.564	Blue
20	10-405996-16	MS27488-20	.060	.090	.564	Red

How to Order: Order by 10- (Proprietary) or MS part number as shown in chart above.

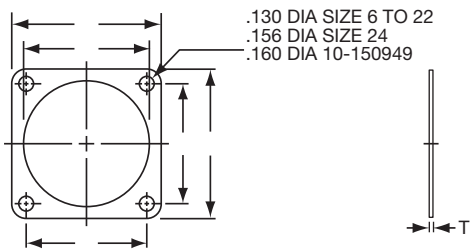

**MOUNTING FLANGE GASKET**  
10-101949-XX  
10-150949-XX

## MOUNTING FLANGE GASKETS – FOR PT & SP

Shell Size	PT 10-101949		SP 10-150949		PT & SP 10-101949 10-150949	
	R ±.010	S ±.010	R ±.010	S ±.010	F +.016 - .000	T ±.008
6	.469	.688	.641	.953	.375	.024
8	.594	.812	.734	1.047	.500	.024
10	.719	.938	.812	1.125	.625	.024
12	.813	1.031	.938	1.250	.750	.024
14	.906	1.125	1.031	1.344	.875	.024
16	.969	1.219	1.125	1.438	1.000	.024
18	1.063	1.312	1.203	1.516	1.125	.024
20	1.156	1.438	1.297	1.672	1.250	.024
22	1.250	1.563	1.375	1.750	1.375	.024
24	1.375	1.688	1.500	1.875	1.500	.024

How to Order: For PT: 10-101949-XX (complete order number with desired shell size).  
For SP: 10-150949-XX (complete order number with desired shell size).

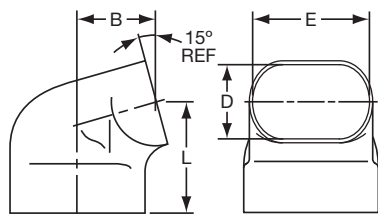

**75° POTTING BOOT**  
10-101988-XX

## 75° POTTING BOOTS – FOR PT & SP

Shell Size	B Max.	D ±.015	E ±.015	L Max.
8	.433	.312	.438	.766
10	.493	.438	.562	.830
12	.552	.516	.688	.861
14	.643	.625	.781	.916
16	.658	.656	.890	.936
18	.689	.703	1.000	.959
20	.750	.766	1.125	1.052
22	.794	.812	1.234	1.073
24	1.070	.918	1.374	1.310

How to Order: 10-101988-XX (complete order number with desired shell size).

All dimensions for reference only

# PT & SP accessories – clamps

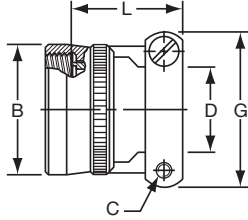

**CLASS "E" STRAIN RELIEF CLAMP  
10-101971-XX**

## CLASS "E" STRAIN RELIEF CLAMP – FOR PT & SP

Shell Size	B Max.	C Thread Class 2B	D Min.	G Max.	L Max.
8	.550	6-32 NC	.240	.812	.930
10	.675	6-32 NC	.302	.875	.930
12	.803	6-32 NC	.428	1.000	.930
14	.920	6-32 NC	.552	1.125	.930
16	1.047	6-32 NC	.615	1.188	1.062
18	1.165	8-32 NC	.740	1.438	1.062
20	1.291	8-32 NC	.740	1.438	1.093
22	1.418	8-32 NC	.928	1.719	1.093
24	1.533	8-32 NC	.928	1.719	1.093

How to Order: 10-101971-XX X

Add desired shell size \_\_\_\_\_ Add desired finish suffix†  
 "3" designates olive drab cadmium  
 "5" designates Alumilite®

Not for use with jam nut style connectors

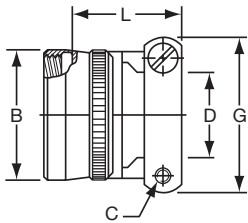

**CLASSES "A" & "P" STRAIN RELIEF CLAMP  
10-101980-XX**

## CLASSES "A" & "P" STRAIN RELIEF CLAMP – FOR PT & SP

Shell Size	B Max.	C Thread Class 2B	D Min.	G Max.	L +.010 - .020
8	.540	6-32 NC	.240	.812	.843
10	.665	6-32 NC	.302	.875	.843
12	.793	6-32 NC	.428	1.000	.843
14	.910	6-32 NC	.552	1.125	.843
16	1.037	6-32 NC	.614	1.188	.975
18	1.155	8-32 NC	.740	1.438	.975
20	1.281	8-32 NC	.740	1.438	1.007
22	1.408	8-32 NC	.928	1.719	1.007
24	1.533	8-32 NC	.938	1.719	1.007

How to Order: 10-101980-XX X

Add desired shell size \_\_\_\_\_ Add desired finish suffix†  
 "3" designates olive drab cadmium  
 "5" designates Alumilite®

Not for use with jam nut style connectors

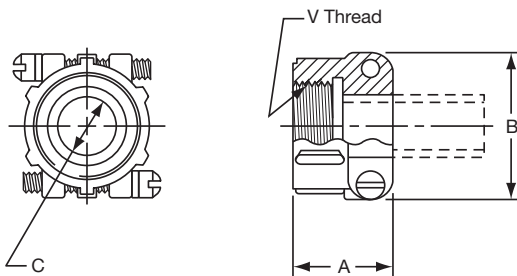

**CLASS "A" CABLE CLAMP  
97-3057-XXXX**

## CLASS "A" CABLE CLAMPS – FOR PT & SP

Shell Size	Amphenol® Part Number	A ±.031	B Max.	C Dia. Min.	V Thread
10	97-3057-1004	.795	.842	.3125	.6250-24
12	97-3057-1007	.850	.995	.4375	.7500-20
14	97-3057-1008	.920	1.120	.5625	.8750-20
16	97-3057-1010	.920	1.216	.6250	1.0000-20
18/20	97-3057-1012	.927	1.403	.7500	1.1875-18
22/24	97-3057-1016	1.015	1.683	.9375	1.4375-18

How to Order: Order by 97-3057-XXXX number listed above. Standard finish is olive drab zinc alloy. Consult Amphenol, Sidney, NY for alternate finishes.

† Standard accessory finishes are "3" olive drab cadmium for PT and MS/PT types, "5" Alumilite® for SP types. Electroless nickel plating is also available on some items; consult Amphenol, Sidney, NY

All dimensions for reference only.

# PT, SP, MS/PT

## accessories – protection caps

### RECEPTACLE PROTECTION CAPS – FOR PT, SP, MS/PT

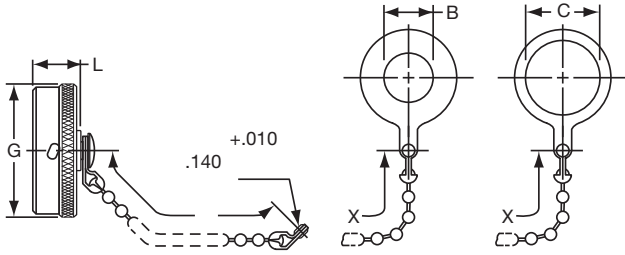

**RECEPTACLE PROTECTION CAP  
FOR PT, SP, MS/PT CONNECTORS**

- 10-101960-XXX  
MS3181-XXX  
(Wall Receptacle)
- 10-101961-XXX  
(Cable Connecting  
Receptacle)
- 10-101964-XXX  
MS3181-XXX  
(Jam Nut Receptacle)

Shell Size	B Dia. +.010 -.000	C Dia. +.010 -.000	G Dia. Max.	L +.020 -.000	X Std. & MS RA, CA, NA	X MS only RAL/CAL/NAL
6	.328	.454	.577	.563	3.000	5.000
8	.454	.578	.706	.563	3.000	5.000
10	.578	.703	.816	.563	3.000	5.000
12	.703	.891	1.000	.563	3.500	5.000
14	.844	1.016	1.128	.563	3.500	5.000
16	.969	1.141	1.257	.563	3.500	5.000
18	1.094	1.266	1.367	.563	3.500	5.000
20	1.219	1.391	1.496	.563	4.000	5.000
22	1.343	1.516	1.624	.563	4.000	5.000
24	1.453	1.614	1.747	.603	4.000	5.000

How to Order Proprietary Receptacle Caps:  
 Wall Receptacle Caps: 10-101960- XX X  
 Cable Connecting Receptacle Caps: 10-101961- XX X  
 Jam Nut Receptacle Caps: 10-101964- XX X  
 Add desired shell size \_\_\_\_\_  
 Add desired finish suffix† \_\_\_\_\_  
 †"FL" designates gray zinc nickel  
 †"3" designates olive drab cadmium  
 †"5" designates Alumilite®

Proprietary caps are supplied with standard bead chains only (as shown in drawing at left). For other chain options, an MS version cap should be ordered.

How to Order MS Version Receptacle Caps:  
 Wall Receptacle Caps: MS3181- XX -CA for sash chain  
 -CAL for long sash chain  
 -RA for rope chain  
 -RAL for long rope chain  
 Jam Nut Recept. Caps: MS3181- XX -NA for sash chain  
 -NAL for long sash chain  
 Shell size \_\_\_\_\_

MS versions are supplied with standard anodize finish only. For other finish options a proprietary cap should be ordered.

### PLUG PROTECTION CAPS – FOR PT, SP, MS/PT

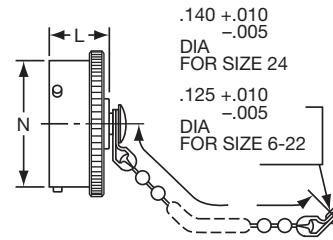

**PLUG PROTECTION CAP  
FOR PT, SP, MS/PT CONNECTORS**

- MS3180-XXX
- 10-101957-XXX

Shell Size	N Dia. +.001 -.005	L Dia. +.025 -.015	X Std. & MS CA, RA	X MS only CAL/ RAL
6	.348	.532	3.000	5.000
8	.473	.532	3.000	5.000
10	.590	.532	3.000	5.000
12	.750	.532	3.500	5.000
14	.875	.532	3.500	5.000
16	1.000	.532	3.500	5.000
18	1.125	.532	3.500	5.000
20	1.250	.594	4.000	5.000
22	1.375	.594	4.000	5.000
24	1.500	.627	4.000	5.000

How to Order Proprietary Plug Caps: 10-101957-XX X  
 Add desired shell size \_\_\_\_\_  
 Add desired finish suffix† \_\_\_\_\_  
 †"FL" designates gray zinc nickel  
 †"3" designates olive drab cadmium  
 †"5" designates Alumilite®

Proprietary caps are supplied with standard bead chains only (as shown in drawing at left). For other chain options an MS version cap should be ordered.

How to Order MS Version Plug Caps: MS3180- XX -CA for sash chain  
 -CAL for long sash chain  
 -RA for rope chain  
 -RAL for long rope chain  
 Shell size \_\_\_\_\_

# PT & SP

accessories – dummy receptacles, “O” rings, plastic dust caps

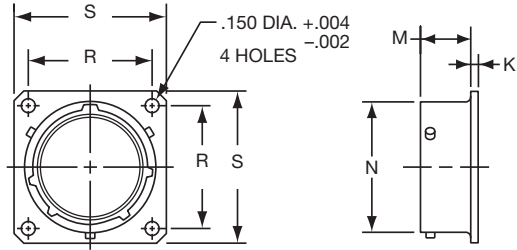

## DUMMY RECEPTACLE FOR PT, SP, MS/PT CONNECTORS

MS3115-XXX  
10-150921-XXX

## DUMMY RECEPTACLES – FOR PT, SP, MS/PT

Shell Size	K ±.010	M +.030 -.000	N +.001 -.005	Proprietary Version		MS Version	
				R ±.005	S ±.010	R <sup>1</sup> (TP)	S <sup>1</sup> (TP)
8	.062	.462	.473	.734	1.047	.594	.828
10	.062	.462	.590	.812	1.125	.719	.954
12	.062	.462	.750	.938	1.250	.812	1.047
14	.062	.462	.875	1.031	1.344	.906	1.141
16	.062	.462	1.000	1.125	1.438	.969	1.234
18	.062	.462	1.125	1.203	1.516	1.062	1.328
20	.062	.556	1.250	1.297	1.672	1.156	1.453
22	.062	.556	1.375	1.375	1.750	1.250	1.578
24	.062	.589	1.500	1.500	1.875	1.375	1.703

How to Order Proprietary Dummy Receptacles: 10-150921-XX X  
 Add desired shell size \_\_\_\_\_  
 Add desired finish suffix† \_\_\_\_\_  
 †“FL” designates gray zinc nickel  
 †“3” designates olive drab cadmium  
 †“5” designates Alumilite®

How to Order MS Version Dummy Receptacles: MS3115-XX X  
 Add desired shell size \_\_\_\_\_  
 Add desired finish suffix† \_\_\_\_\_  
 †-A designates Alumilite®  
 †-L designates electroless nickel  
 †-W designates olive drab cadmium

## PLASTIC DUST CAPS – FOR PT, SP

Shell Size	Plug Plastic Dust Cap	Receptacle Plastic Dust Cap
6	10-70500-8	10-70506-8S
8	10-70506-12	10-70506-10
10	10-70500-12	10-70506-12
12	10-70506-16	10-70506-14
14	10-70506-18	10-70506-16
16	10-70506-20	10-70506-18
18	10-70506-22	10-70506-20
20	10-70506-24	10-79506-22
22	10-70524-1	10-70506-24
24	10-70506-28	10-70524-1

How to Order Plastic Dust Caps:

To the basic order number add the dust cap size to match connector plug or receptacle shell size, as shown in the tables above.  
 Example: 10-70506-12 would be the correct order number for a plastic dust cap for a PT00 receptacle, shell size 10.

All dimensions for reference only.



# PT accessories glands

## Nylon Cable Glands

**Material:** Nylon 66 (UL Approved 94V-2)  
**Seal ring:** UL 94V-2 (UL Approved 94V-2)  
**Thread Type:** Metric; PG, NPT  
**Temp Range:** Static: -40° to +100°C  
 Dynamic: -20° to +80°C  
 Short Term: +120°C  
**Current Colors:** Gray, Black

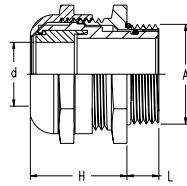

AIGO Part	Thread "A"	M "d" (mm)	Cable Range (mm)	Thread "L" (mm)	Clamp "H" (mm)	Spanner "S" (mm)
AIO-CSM12	M12 x1.5	8	3-6.5	8	20	15
AIO-CSM16	M16 x 1.5	8	4-8	8	22	19
AIO-CSM18	M18 x 1.5	10	5-10	9	25	22
AIO-CSM18	M20 x 1.5	12	6-12	9	30	24
AIO-CSM20	M22 x 1.5	14	10-14	10	30	27
AIO-CSM22	M24 x 1.5	14	10-14	10	30	27
AIO-CSM24	M25 x 1.5	18	13-18	10	30	33
AIO-CSM25	M30 x 2.0	18	13-18	11	33	33
AIO-CSM30	M32 x 1.5	25	18-25	11	38	42
AIO-CSM32	M33 x 2.0	25	18-25	11	39	42
AIO-CSM33	M40 x 1.5	32	22-32	13	48	54
AIO-CSM40	M50 x 1.5	38	32-38	14	50	60
AIO-CSM50	M72 x 2.0	57	51-57	16	75	80
AIO-CSM72	NPT1/2"	12	6-12	13.6	28	24
AIO-CSIN1/2	NPT 3/4"	18	13-18	14.1	32	33
AIO-CSIN3/4	NPT 1"1/2"	32	22-32	17.3	50	54
AIO-CSIN3/2	G 1/2"	12	6-12	9	26	24
AIO-CSGIN3/4	G 3/4"	18	13-18	11	27	33
AIO-CSGIN1	G1"	25	18-25	11	33	42
AIO-CSGIN5/4	G1"1/4	28	21-28	13	48	54
AIO-CSGIN3/2	G1"1/2"	32	22-32	13	48	54
AIO-CSGIN5/2	G2"1/2"	57	51-57	14	75	80
AIO-CSPG7	PG7	6.5	3-6.5	8	20	15
AIO-CSPG9	PG9	8	4-8	8	22	19
AIO-CSPG11	PG11	10	5-10	8	24	22
AIO-CSPG13.5	PG13.5	12	6-12	9	26	24
AIO-CSPG16	PG16	14	10-14	10	28	27
AIO-CSPG21	PG21	18	13-18	11	33	33
AIO-CSPG29	PG29	25	18-25	11	38	42
AIO-CSPG36	PG36	32	22-32	13	48	54
AIO-CSPG42	PG42	38	32-38	14	52	60

For additional information on other products available refer to our Cord grips & Cable Glands, Catalog 12-055

## Metal Cable Glands

**Material:** Brass with Nickel; Brass with Tin/Nickel  
**Clamping:** UL approved PA6, 94V-0  
**Seal Ring:** UL 94V-2 (UL approved NBR, 94V-2; UL approved DOW CORNING RUBBER, 94V-0)  
**Thread Type:** Metric, PG, NPT  
**Protective:** IP68 (tighten with o-ring)  
**Temp Range:** -40° to +100°C

Torque Value (N-M) of hex and cap nuts: 3.0-4.5 N-M M12, M16, M20 are UL recognized under file #E339605

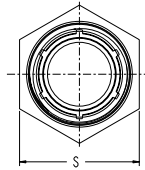

AIGO Part	Thread "A"	M "d" (mm)	Cable Range (mm)	Thread "L" (mm)	Clamp "H" (mm)	Spanner "S" (mm)
AIO-CSJM12	M12x1.5	6.5	3-6.5	6.2	15	14
AIO-CSJM14	M14x1.5	8	4-8	5	19	15
AIO-CSJM16	M16x1.5	9	6-9	6.3	20	18
AIO-CSJM18	M18x1.5	10	5-10	7	20	22
AIO-CSJM20	M20x1.5	12	6-12	8.3	20	22
AIO-CSJM22	M22x1.5	14	10-14	8	24	24
AIO-CSJM24	M24x1.5	14	10-14	8	24	27
AIO-CSJM25	M25x1.5	18	13-18	7.8	23	30
AIO-CSJM27	M27x1.5	18	13-18	8	26	30
AIO-CSJM30	M30x2.0	18	13-18	8	26	32
AIO-CSJM32	M32x1.5	25	18-25	10	27	40
AIO-CSJM36	M36x2.0	25	18-25	10	34	40
AIO-CSJM40	M40x1.5	32	22-32	10	39	50
AIO-CSJM50	M50x1.5	38	32-38	11	39	60
AIO-CSJM63	M63x1.5	44	37-44	12	43	67
AIO-CSJM72	M72x1.5	52	46-52	16	47	75
AIO-CSJM80	M80x2.0	60	52-60	20	57	90
AIO-CSJM90	M90x2.0	70	62-70	20	57	100
AIO-CSJIN1/2	NPT 1/2"	12	6-12	13.6	25	24
AIO-CSJIN3/4	NPT 3/4"	18	13-18	14.1	26	30
AIO-CSJIN5/4	NPT 1"1/4"	32	22-32	17.3	41	50
AIO-CSJIN3/2	NPT 1"1/2"	32	22-32	17.3	46	50
AIO-CSJIN2	NPT2"	44	37-44	17.7	46	65
AIO-CSJIN5/2	NPT2 1/2"	52	46-52	23.7	58	80
AIO-CSJIN3	NPT3"	70	62-70	26	58	100
AIO-CSJGIN1/2	G1/2"	12	6-12	8	24	24
AIO-CSJGIN3/4	G3/4"	18	13-18	8	27	30
AIO-CSJGIN1	G1"	25	18-25	10	34	40
AIO-CSJGIN5/4	G1"1/4"	32	22-32	10	39	50
AIO-CSJGIN3/2	G1"1/2"	32	22-32	10	39	50
AIO-CSJGIN2	G2"	44	37-44	12	44	65
AIO-CSJGIN 5/2	G2 1/2"	52	46-52	16	47	82
AIO-CSJPG7	PG7	6.5	3-6.5	6	18	14
AIO-CSJPG9	PG9	8	4-8	7	21	18
AIO-CSJPG11	PG11	10	5-10	7	20	22
AIO-CSJPG13.5	PG13.5	12	6-12	8	24	22
AIO-CSJPG16	PG16	14	10-14	8	25	24
AIO-CSJPG21	PG21	18	13-18	8	26	30
AIO-CSJPG36	PG36	32	22-32	10	38	50
AIO-CSJPG42	PG42	38	32-38	11	42	60
AIO-CSJPG48	PG48	44	37-44	12	44	65

# Application Tools

## “SE”

The following data includes information pertaining to the application tools for crimping, inserting and removing size 20, 16, and 12 contacts incorporated in Amphenol® Miniature Cylindrical Connectors.

All crimping tools included are the “full cycling” type, and when used as specified by the manufacturer, provide reliable crimped wire to contact termination.

Tool frames and turret heads are available from approved tool manufacturers; consult Amphenol, Sidney, NY for listings.

Assembly instructions are available online at [www.amphenol-industrial.com](http://www.amphenol-industrial.com)

See the following:

L-786 for SE assembly instructions

L-555 for solder type instructions

### CRIMPING TOOLS

#### FOR PT-SE, SP-SE, MS/PT-SE (MIL-DTL-26482, Series 1) Connectors

Contact Size	MS Tool Part Number	
	Tool From	Turret Head
20	M22520/1-01	M22520/1-02
16	M22520/1-01	M22520/1-02
12	M22520/1-01	M22520/1-02

### INSERTION/REMOVAL TOOLS

#### FOR PT-SE, SP-SE, MS/PT-SE (MIL-DTL-26482, Series 1) Connectors

Contact Size	Insertion Tool			Removal Tool	
	Amphenol® Contact Insertion Pliers	Amphenol® Contact Insertion Tool	MS Part Number Contact Insertion Tool	Amphenol® Contact Removal Tool	MS Part Number Contact Removal Tool
20	11-8107-20	11-7401-20	M81969/17-03	11-7880-20	M81969/19-07
16	11-8107-16	11-7401-16	M81969/17-04	11-7880-16	M81969/19-08
12	-	-	M81969/17-05	-	M81969/19-09

# Contacts - Power and Thermocouple Crimp

## for miniature cylindrical connectors

The following tables provide part number information for crimp contacts used in Amphenol® Miniature Cylindrical Connectors. For additional information, consult Amphenol, Sidney, NY.

### CRIMP CONTACTS for MIL-DTL-26482, Series 1 (PT-SE, SP-SE) Connectors

Contact Size	Accommodates Wire Size	Pins		Sockets	
		MS Number	Amphenol® Proprietary Number	MS Number	Amphenol® Proprietary Number
20	20, 22 & 24 AWG	M39029/31-240	10-683787-20P	M39029/32-259	10-731210-3D1
16	16, 18 & 20 AWG	M39029/31-228	10-683788-16P	M39029/32-247	10-679379-16D
12	12 & 14 AWG	M39029/31-235	10-807100-125	M39029/32-254	10-807103-125
20-16	16 AWG		10-330930-20F		10-807155-205
16-20	20 AWG		10-330932-16F		10-330933-16F
12-10	12 AWG		10-330938-12F		10-330939-12F

### THERMOCOUPLE CONTACTS for Miniature Connectors

Size	Material	Pins Proprietary Part Number	Sockets Proprietary Part Number
		SE	SE
16 Crimp Termination	Chromel	10-330940-21P	10-330940-21S
	Alumel	10-330940-22P	10-330940-22S
20 Crimp Termination	Chromel	10-330940-1P	10-330940-1S
	Alumel	10-330940-2P	10-330940-2S
	Iron	10-330940-3P	10-330940-3S
	Constantan	10-330940-4P	10-330940-4S

See L-776 for thermocouple contact termination instructions. These are online at [www.amphenol-industrial.com](http://www.amphenol-industrial.com) For PCB contacts for miniature connectors, see page 20.

# Coaxial Contacts

## for miniature cylindrical connectors

Amphenol® Miniature Connectors can incorporate shielded coax contacts. The Miniature family is built around MIL-DTL-26482 specifications, with Mil-approved and proprietary styles offered. Normal operating voltage for Miniature cylindricals with power only contacts is up to 1,000 VAC (RMS) at sea level.

### Table 1: Miniature Cylindricals offer these features for contact termination flexibility:

- Several insert arrangements that can incorporate:
- Size 8 & 12 Crimp Coax contacts for Crimp type
- Size 8 & 12 Solder Coax contacts for Solder type
- Wide selection of connector shell styles and sizes
- Standard power contact options within the various connector styles include: solder type, crimp front release, crimp rear release
- Coax contacts are designed to the same high performance standards as power contacts. Coax and power contacts may be intermixed with no degradation of connector reliability.
- No mis-mating or cross-plugging with insert rotation and keyway polarization.

### Table 2: GENERAL ORDERING INFORMATION

Amphenol Miniature Cylindricals are normally supplied with a full complement of power contacts, separately packaged. Coax contacts are ordered by part number as referenced in the part number charts on the following pages of this catalog, and are substituted for the power contacts at the time of the cable or equipment assembly. If the application is for coax only, the connector may be ordered less contacts and no power contacts will be supplied.

Installation instructions for the coax contacts for Miniature Connectors are provided in Amphenol documents as follows: L-633 for solder type; L-613 for SE type.

### HOW TO ORDER:

- A. Select the coax contacts designed for the cable being used from the applicable charts in this catalog for each Miniature type (solder, SE).
- B. Select a connector insert from those shown on pages 4-5 which will accommodate the quantity and size of coaxial contacts needed plus any power contacts required. Note: Size 8S and 12S contacts are used with connector inserts through shell size 18 only. For larger connector shell sizes, use size 8L contacts.
- C. Determine the Miniature Cylindrical type, shell style, finish, service class and insert rotation required for your application.
- D. Consult Amphenol, Sidney NY with the pertinent cable, contact, insert arrangement and connector style choices for complete connector part number.



**Solder Coax Contact**  
for use in Miniature Solder Type Connectors



**Pin Crimp Coax Contact**  
for use in Miniature Crimp SE Type Connectors



**Socket Crimp Coax Contact**  
for use in Miniature Crimp SE Type Connectors

# Coaxial Contacts

for miniature cylindrical connectors, cont.

**Amphenol® Coaxial Contacts** designed for use in Miniature Cylindrical Connectors offer the same durability advantages and design benefits for reliable interconnection as the Amphenol coax contacts used in high performance D38999 connectors. A variety of military and commercial shielded cables are accommodated within the miniature cylindrical series. Amphenol supplies coax contacts for solder and crimp SE connector styles.

Other features of the coax for miniature cylindricals include:

- Miniature coax design has an outside nut within the assembly for fast, reliable assembly of contact to cable.
- All types feature solder style inner contacts and crimp style outer contacts for reliable cable termination
- Miniature coax crimp type contacts are designed for use in Miniature crimp series connectors
- Miniature coax solder type contacts are designed for use in Miniature solder series connectors. These come pre-installed into the solder connector.

**TYPICAL MINIATURE CRIMP COAX SOCKET CONTACT** has crimp socket outer contact with a solder pin inner contact

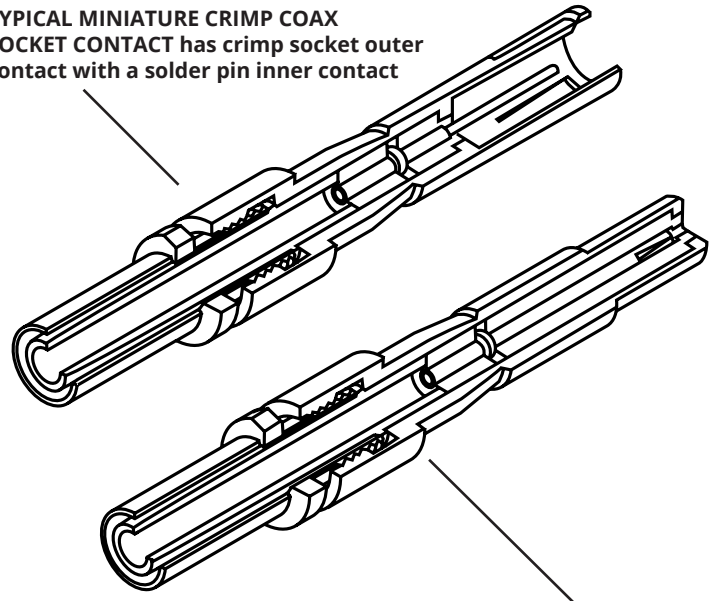

**TYPICAL MINIATURE CRIMP COAX PIN CONTACT** has crimp pin outer contact with a solder socket inner contact

## TYPICAL ELECTRICAL PERFORMANCE Size 8 and 12 Coax Contacts

### Contact Resistance:

Center @ 1 Amp, 170 millivolts max. voltage drop @ 25°C  
Outer @ 12 Amps, 150 millivolts max. voltage drop @ 25°C

### Dielectric Withstanding Voltage:

Size 8: 1,300 VAC Rms @ sea level  
Size 12: 1,000 VAC Rms @ sea level  
Size 8 & 12: 250 VAC Rms @ 50,000 ft.

### Insulation Resistance

5,000 megohms minimum @ 25°C  
Typical VSWR for size 8 & 12 PT-SE Types II & III only:  
1.2 + .12F (GHz) up to 10 GHz

### EXPLANATION OF TYPE CLASSIFICATIONS:

PT-SE Type I is moisture seal design with internal O-ring.  
PT-SE Type II is 50 ohm impedance matched version. Contacts terminated to other than 50 ohm cables are therefore not matched.

PT-SE Type III is 50 ohm contact, non-serviceable after assembly.  
Solders are non-impedance matched contacts.

### CONTACT FINISHES:

Suffix Finish	
1	0.00020 min. silver over copper flash
2	0.00005 min. gold (Knoop hardness 130-200) over silver
3	0.00010 min. gold (Knoop hardness 130-200) over silver
4	0.00010 min. gold (Knoop hardness 130-200) over copper
5	0.00005 min. gold (Knoop hardness 130-200) over nickel
E	0.00005 min. gold (Knoop hardness 90 max.) over copper
F	0.00005 min. gold (Knoop hardness 130-200) over copper
H	0.00010 min. gold (Knoop hardness 130-200) over copper

# Coaxial Contacts

for miniature cylindrical connectors, cont.

solder (MIL-DTL-26482 Series 1 type) - application data

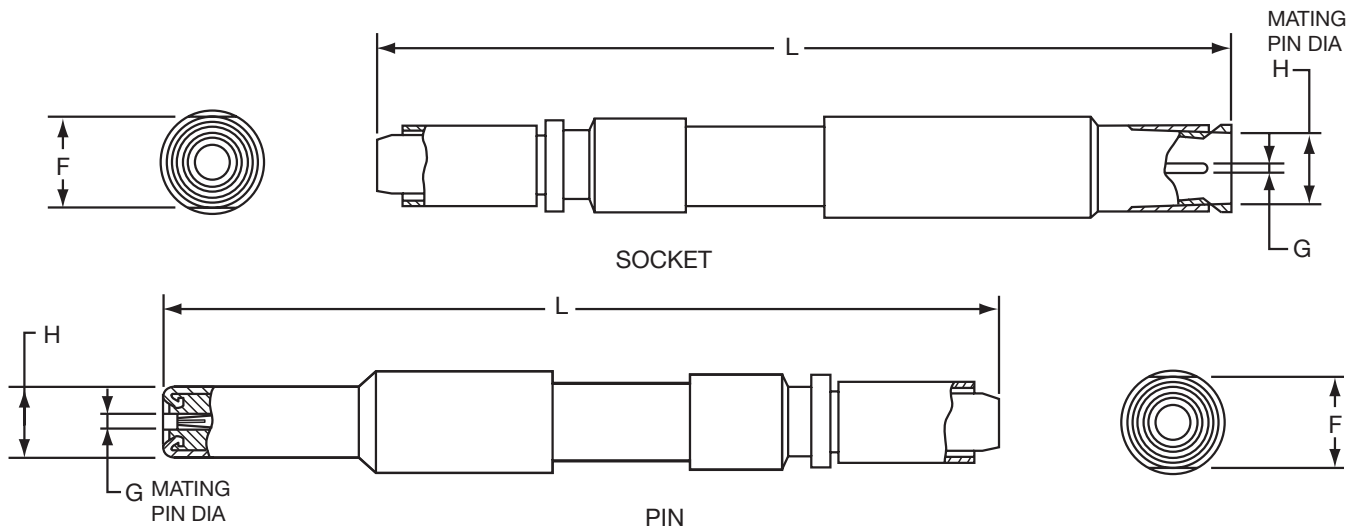

SOLDER COAX CONTACTS												
For use in Miniature Solder Type Connectors: PT, SP, and MS/PT Styles												
Cable	Contact Part Number		Contact Size	Dimensional Data (See Drawings above)					Crimp Ferrule Tools			Retainer Nut Wrench
	Pin	Socket		G Dia.	H Dia. ±0.001	F Across Flats ±0.004	L Length Ref.		MIL-T-22910/7-1 Tool Use with Die Part Number	MIL-C-22520/5-01 Tool Use with Die Part Number	MIL-C-22520/10-01 Tool Use with Die Part Number	
							Pin	Socket				
RG-58C/U, RG-141A/U, RG-303/U	21-33020-2	21-33019-2	8S	0.040 ± 0.001	0.219	0.280	1.114	1.115	M22910/7-15 (B)	M22520/5-05 (B) M22520/5-41 (B)	M22520/10-07 (B)	11-8676-2
RG-59B/U, RG-62A/U, RG-62B/U, RG-210/U	21-33020-1	21-33019-1	8L	0.040 ± 0.001	0.219	0.280	1.176	1.177	M22910/7-18 (B)	M22520/5-45 (B)		11-8676-3
	21-33020-3	21-33019-3	8S	0.040 ± 0.001	0.219	0.280	1.114	1.115				
RG-142B/U, Times MI51115	21-33020-7*	21-33019-7*	8S	0.040 ± 0.001	0.219	0.280	1.114	1.115	M22910/7-16 (B)	M22520/5-43 (B)		11-8678-2
RG-161/U, RG-174A/U, RG-179B/U, RG-187A/U, RG-188A/U, RG-316/U	21-33020-32*	21-33019-32*	12S	0.0300 ± 0.0005	0.140	0.172	1.092	1.093	M22910/7-12 (B)	M22520/5-03 (A) M22520/5-08 (A) M22520/5-35 (B)	M22520/10-05 (A)	11-8676-1
RG-178B/U	21-33020-4	21-33019-4*	8S	0.040 ± 0.001	0.219	0.280	1.114	1.115	M22910/7-11 (B)	M22520/5-03 (B) M22520/5-33 (B)	M22520/10-05 (B)	11-8676-2
RG-196A/U	21-33020-31†	21-33061-31†	12S	0.0300 ± 0.0005	0.140	0.172	1.092	1.093	M22910/7-11 (B)	M22520/5-03 (B) M22520/5-33 (B)	M22520/10-05 (B)	11-8676-1
RG-180B/U, RG-195A/U, Raychem 5022D1312-9	21-33020-5*	21-33019-5*	8S	0.040 ± 0.001	0.219	0.280	1.114	1.115	M22910/7-15 (B)	M22520/5-05 (B) M22520/5-41 (B)	M22520/10-07 (B)	11-8676-2
Raychem 5021D1331-9	21-33020-6*	21-33019-6*	8S	0.040 ± 0.001	0.219	0.280	1.114	1.115	M22910/7-15 (B)	M22520/5-05 (B) M22520/5-41 (B)	M22520/10-07 (B)	11-8676-2
Thermatics 2929-29	21-33020-33	21-33061-33	12S	0.0200 ± 0.0005	0.140	0.172	1.092	1.093	M22910/7-13 (B)	M22520/5-37 (B)		11-8676-1

NOTE: Contacts can be ordered by part numbers given in chart  
NOTE: Size 8S and 12S contacts are used with connector inserts through shell size 18 only. For larger connector shell sizes, use size 8L contacts.

CONTACT FINISH: For all contacts in this series feature 0.000050 minimum gold (Knoop hardness 130-200).

\* Consult Amphenol, Sidney NY for availability  
CRIMPING TOOLS: Italicized letters in parenthesis that follow positioner part numbers indicate applicable die closure. Commercial equivalents with the same die closure dimension may be used.  
† 21-33020-31 and 21-33061-31 only mate with each other

# Coaxial Contacts

for miniature cylindrical connectors, cont.

crimp SE (MIL-DTL-26482 Series 1 type) - application data

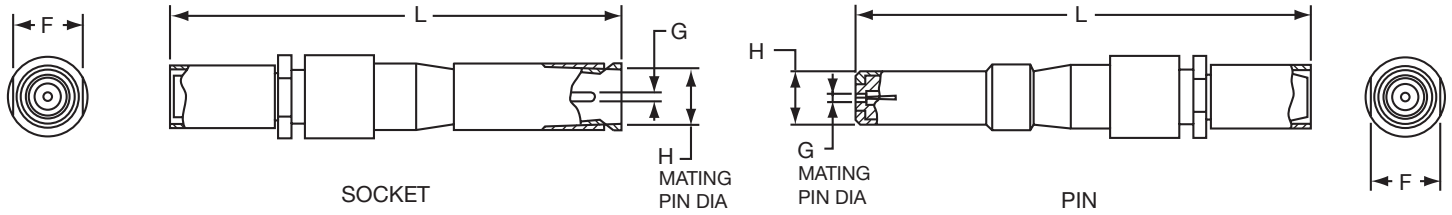

NOTE: All contacts of the same size and the same inner and outer contact diameters (G & H) will mate with each other.

SE CRIMP COAX CONTACTS																		
For use in Miniature Crimp Type Connectors: PT-SE, SP-SE, and MS/PT-SE Styles																		
Cable	Contact Part Number		Contact Size	Type	Finish on Mating Parts	Dimensional Data (See Drawings above)				Crimp Ferrule Tools			Retainer Nut Wrench	Installation Tools				
	Pin	Socket				G Dia.	H Dia. ±0.001	F Across Flats ±0.004	L Length Ref.		MIL-T-22910/7-1 Tool Use with Die Part Number	MIL-C-22520/5-01 Tool Use with Die Part Number		MIL-C-22520/10-0 Tool Use with Die Part Number	Insertion	Removal		
									Pin	Socket								
RG-55B/U, RG-142A/U, RG-142B/U, RG-223/U	21-33012-21	21-33011-21	8	I	2	0.0355 ±0.0010	0.218	0.280	1.156	1.144	M22910/7-17 (B)	M22520/5-05 (A) M22520/5-19 (B)	M22520/10-07 (A)	11-8676-2	11-8369-5 11-8660-5	11-7880-8 11-8154-1		
	21-33012-25	21-33011-25	8	II	4													
	21-33038-21	21-33037-21	8	I	4													
	21-33038-25*	21-33037-25	8	II	4													
	21-33138-21(*)	21-33137-21(*)	8	I	**													
	21-33138-25(*)	21-33137-25(*)	8	II	**													
RG-58C/U, RG-141A/U, RG-303/U	21-33012-22	21-33011-22	8	I	2	0.0355 ±0.0010	0.218	0.280	1.156	1.144	M22910/7-15 (B)	M22520/5-05 (B) M22520/5-41 (B)	M22520/10-07 (B)	11-8676-2	11-8369-4 11-8660-4	11-7880-8 11-8154-1		
	21-33012-26	21-33011-26	8	II	4													
	21-33038-22*	21-33037-22	8	I	4													
	21-33038-26*	21-33037-26*	8	II	4													
	21-33138-22(*)	21-33137-22(*)	8	I	**													
	21-33138-26(*)	21-33137-26(*)	8	II	**													
RG-59B/U, RG-62A/U, RG-62B/U, RG-210/U	21-33012-36	21-33011-36	8	II	2	0.0355 ±0.0010	0.218	0.280	1.156	1.144	M22910/7-18 (B)	M22520/5-45 (B)		11-8676-3	11-8369-5 11-8660-5	11-7880-8 11-8154-1		
	21-33038-36*	21-33037-36	8	II	4													
	21-33138-36(*)	21-33137-36(*)	8	II	**													
	21-33012-37*	21-33011-37*	8	II	2													
RG-140/U, RG-302/U	21-33038-37*	21-33037-37*	8	II	4	0.0355 ±0.0010	0.218	0.280	1.156	1.144	M22910/7-17 (B)	M22520/5-05 (A) M22520/5-19 (B)	M22520/10-07 (A)	11-8676-2	11-8369-5 11-8660-5	11-7880-8 11-8154-1		
	21-33138-37(*)	21-33137-37(*)	8	II	**													
RG-161/U, RG-174A/U, RG-179B/U, RG-187A/U, RG-188A/U, RG-316/U	21-33012-34	21-33011-34	8	I	2	0.0355 ±0.0010	0.218	0.280	1.156	1.144				11-8676-2		11-7880-8 11-8154-1		
	21-33012-30	21-33011-30	8	II	2													
	21-33038-34	21-33037-34	8	I	4													
	21-33038-30	21-33037-30	8	II	4													
		21-33138-34(*)	21-33137-34(*)	8	I	**												
		21-33138-30(*)	21-33137-30(*)	8	II	**												
		21-33012-1	21-33011-1	12	I	2	0.0200 ±0.0005	0.128	0.172	1.092	1.072	M22910/7-12 (B)	M22520/5-03 (A) M22520/5-08 (A) M22520/5-35 (B)	M22520/10-05 (A)	11-8369-2 11-8660-2			
		21-33012-4	21-33011-4	12	II	2												
		21-33038-1*	21-33037-1*	12	I	4									11-8676-1		11-7880-12 11-8154-2	
		21-33038-4	21-33037-4*	12	II	4												
	21-33138-1(*)	21-33137-1(*)	12	I	**													
	21-33138-4(*)	21-33137-4(*)	12	II	**													
	21-33012-35	21-33011-35	8	I	2	0.0355 ±0.0010	0.218	0.280	1.156	1.144				11-8676-2		11-7880-8 11-7880-8		
	21-33038-35	21-33037-35	8	I	4													
	21-33138-35(*)	21-33137-35(*)	8	I	**													
RG-178B/U, RG-196A/U	21-33012-3*	21-33011-3*	12	I	2	0.0200 ±0.0005	0.128	0.172	1.092	1.072	M22910/7-11 (B)	M22520/5-03 (B) M22520/5-33 (B)		11-8676-1	11-8369-1 11-8660-1	11-7880-12 11-8154-2		
	21-33012-5	21-33011-5	12	II	2													
	21-33038-3*	21-33037-3*	12	I	4													
	21-33038-5	21-33037-5*	12	II	4													
	21-33138-3(*)	21-33137-3(*)	12	I	**													
	21-33138-5(*)	21-33137-5(*)	12	II	**													

NOTE: Contacts can be ordered by part numbers given in chart  
 \*\* See finish options for SE crimp Miniature contacts listed on page 44. Replace the parenthesis of the contact part number with the finish suffix number. However, you should consult Amphenol, Sidney, NY regarding the availability of all finish choices for each part number.

\* Consult Amphenol, Sidney NY for availability

CRIMPING TOOLS: Italicized letters in parenthesis that follow positioner part numbers indicate applicable die closure. Commercial equivalents with the same die closure dimension may be used.

CHART CONTINUES ON NEXT PAGE



# Coaxial Contacts

for miniature cylindrical connectors, cont.

crimp SE (MIL-MDL-26482 Series 1 type) - application data, cont.

SE CRIMP COAX CONTACTS																
For use in Miniature Crimp Type Connectors: PT-SE, SP-SE, and MS/PT-SE Styles																
Cable	Contact Part Number		Contact Size	Type	Finish on Mating parts	G Dia.	Dimensional Data				Crimp Ferrule Tools			Retainer Nut Wrench	Installation Tools	
							H Dia. ±0.001	F Across Flats ±0.004	L Length Ref.		MIL-T-22910/7-1 Tool Use with Die Part Number	47MIL-C-22520/5-01 Tool Use with Die Part Number	MIL-C-22520/10-0 Tool Use with Die Part Number		Insertion	Removal
	Pin	Socket														
RG-180B/U, RG-195A/U	21-33012-24 21-33012-46*	21-33011-24 21-33011-46*	8 8	I II	2	0.0355 ± 0.0010	0.218	0.280	1.156	1.114	M22520/7-15 (B)	M22520/5-05 (B) M22520/5-41 (B)	M22520/10-07 (B)	11-8676-2	11-8369-4	11-7880-8
	21-33038-24 21-33038-46*	21-33037-24 21-33037-46*	8 8	I II	4										11-8660-4	11-8154-1
	21-33138-24(*) 21-33138-46(*)	21-33137-24(*) 21-33137-46(*)	8 8	I II	**											
Raychem 9527E1118, RG-180B/U, RG-195A/U	21-33106-40()	21-33105-40()	12	III	**	0.0200 ± 0.0005	0.128		0.899	0.879	Daniels GS200 Tool with G2P330 or M22520/31-01 Tool with Positioner M22520/31-02			11-8674-2	11-7880-12 11-8154-2	
RG-188 or RG-316 Double Braid	21-33012-6* 21-33012-7*	21-33011-6* 21-33011-7*	12 12	I II	2	0.0200 ± 0.0005	0.128	0.172	1.092	1.072	M22910/7-13 (B)	M22520/5-37 (B)		11-8676-1	11-8369-2	11-7880-12
	21-33038-6* 21-33038-7*	21-33037-6* 21-33037-7*	12 12	I II	4										11-8660-2	11-8154-2
	21-33138-6(*) 21-33138-7(*)	21-33137-6(*) 21-33137-7(*)	12 12	I II	**											
Thermax 50C-25ADS-1	21-33012-44	21-33011-44	8	II	2	0.0355 ± 0.0010	0.128	0.280	1.156	1.144				11-8676-2	11-8369-4	11-7880-8
	21-33038-44*	21-33037-44*	8	II	4										11-8660-4	11-8154-1
	21-33138-44(*)	21-33137-44(*)	8	II	**											
RG-195 Double Braid	21-33012-28	21-33011-28	8	I	2	0.0355 ± 0.0010	0.128	0.280	1.156	1.144	M22910/7-16 (B)	M22520/5-43 (B)		11-8676-2	11-8369-4	11-7880-8
	21-33038-28*	21-33037-28*	8	I	4										11-8660-4	11-8154-1
	21-33138-28(*)	21-33137-28(*)	8	I	**											
RG-122/U, Raychem 5022E5111	21-33012-23 21-33012-27	21-33011-23 21-33011-27	8 8	I II	2	0.0355 ± 0.0010	0.218	0.280	1.156	1.144	M22520/7-15 (B)	M22520/5-05 (B) M22520/5-41 (B)	M22520/10-07 (B)	11-8676-2	11-8369-4	11-7880-8
	21-33038-23* 21-33038-27	21-33037-23* 21-33037-27	8 8	I II	4										11-8660-4	11-8154-1
	21-33138-23(*) 21-33138-27(*)	21-33137-23(*) 21-33137-27(*)	8 8	I II	**											
Raychem 9530D5314	21-33012-31	21-33011-31	8	I	2	0.0355 ± 0.0010	0.218	0.280	1.156	1.144	M22910/7-15 (B)	M22520/5-05 (B) M22520/5-41 (B)	M22520/10-07 (B)	11-8676-2	11-8369-4	11-7880-8
	21-33038-31	21-33037-31	8	I	4										11-8660-4	11-8154-1
	21-33138-31(*)	21-33137-31(*)	8	I	**											
Raychem 9527A1317	21-33012-39	21-33011-39	8	II	2	0.0355 ± 0.0010	0.218	0.280	1.156	1.144	M22910/7-15 (B)	M22520/5-05 (B) M22520/5-41 (B)	M22520/10-07 (B)	11-8676-2	11-8369-4	11-7880-8
	21-33038-39*	21-33037-39*	8	II	4										11-8660-4	11-8154-1
	21-33138-39(*)	21-33137-39(*)	8	II	**											
Raychem 7527A1318	21-33012-40*	21-33011-40	8	II	2	0.0355 ± 0.0010	0.218	0.280	1.156	1.144	M22910/7-12 (B)	M22520/5-03 (A) M22520/5-08 (A) M22520/5-35 (B)	M22520/10-05 (A)	11-8676-2	11-8369-2	11-7880-8
	21-33038-40*	21-33037-40*	8	II	4										11-8660-2	11-8154-1
	21-33138-40*	21-33137-40(*)	8	II	**											
Westrex 199-49-1, Tensolite 30850/87T-1	21-33012-43	21-33011-43	12	II	2	0.0200 ± 0.0005	0.128	0.172	1.092	1.072	M22910/7-11 (B)	M22520/5-03 (B) M22520/5-33 (B)	M22520/10-05 (B)	11-8676-1	11-8369-1	11-7880-12
	21-33038-43	21-33037-43	12	II	4										11-8660-1	11-8154-2
	21-33138-43(*)	21-33137-43(*)	12	II	**											

NOTE: Contacts can be ordered by part numbers given in chart  
 \*\* See finish options for SE crimp Miniature contacts listed on page 44.  
 Replace the parenthesis of the contact part number with the finish suffix number. However, you should consult Amphenol, Sidney, NY regarding the availability of all finish choices for each part number.  
 \* Consult Amphenol, Sidney NY for availability

CRIMPING TOOLS: Italicized letters in parenthesis that follow positioner part numbers indicate applicable die closure. Commercial equivalents with the same die closure dimension may be used.



# Mounting Recommendations

## for miniature cylindrical connectors

### FLANGE MOUNTED CONNECTORS

All flange mounting PT connectors use standard MS mounting dimensions. They cannot be back panel mounted due to coupling clearance. The PTB (thru-bulkhead) type connector must also be back panel mounted on one side. Flange gaskets are available for both series, see page 37.

Shell Size	R (TP)		D Dia.	
	PT, PTB	SP	PT	SP, PTB
6	.469	.641	.323	.439
8	.594	.734	.449	.563
10	.719	.812	.573	.680
12	.812	.938	.699	.859
14	.906	1.031	.823	.984
16	.969	1.125	.949	1.108
18	1.062	1.203	1.073	1.233
20	1.156	1.297	1.199	1.358
22	1.250	1.375	1.323	1.483
24	1.375	1.449	1.449	-

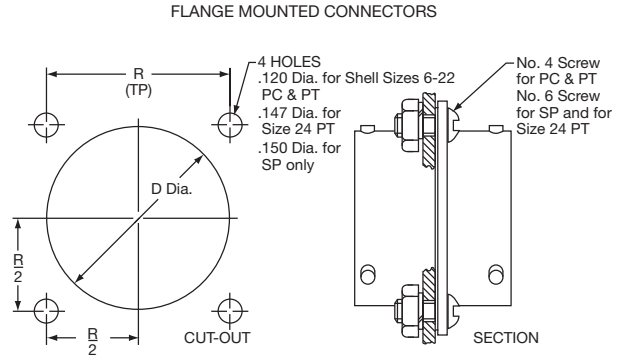

### JAM NUT MOUNTINGS

The jam nut design has become very popular because it allows bench wiring of harness assemblies. The labor saving often offsets the added cost of the jam nut receptacle which is due to the self contained "O" ring and the extra nut.

Shell Size	R +.010 -.000	B +.000 -.010	F ±.010	P Panel Thickness	
				Min.	Max.
6	.447	.420	.286	.062	.125
8	.572	.542	.331	.062	.125
10	.697	.669	.375	.062	.125
12	.884	.830	.442	.062	.125
14	1.007	.955	.486	.062	.125
16	1.134	1.084	.530	.062	.125
18	1.259	1.208	.573	.062	.125
20	1.384	1.333	.641	.062	.250
22	1.507	1.459	.685	.062	.250
24	1.634	1.575	-	.062	.250

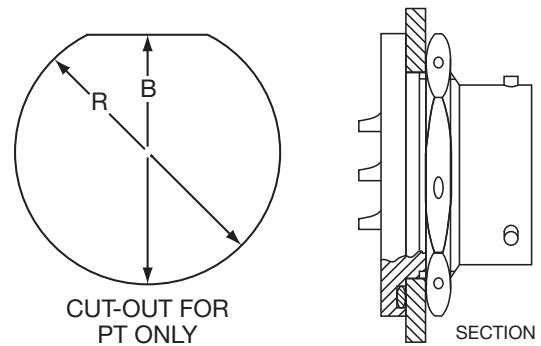

### HERMETIC RECEPTACLE MOUNTINGS

This series must be mounted in such a way as to preserve the hermetic seal provided by the glass insert. Mounting data for box and jam nut receptacles is given above. Cut-out required for solder mounting receptacles (N) is given below.

The finish of each of these hermetic receptacles is fused electro-deposited tin for easy solderability, and protected by a special lacquer for optimum shelf life. The lacquer will not interfere with any soldering operation.

Low temperature solder should be used and the addition of a solder fillet at arrow points on drawing at right is recommended. Care must be taken that the operating temperature of the final assembly does not rise above the melting point of tin (440° F).

Shell Size	N Max.
6	.458
8	.582
10	.692
12	.801
14	.926
16	1.051
18	1.176
20	1.395
22	1.375
24	1.520



# Other Amphenol Miniature Cylindrical Connectors

## Geophysical Miniature Cylindricals

Designed for the Geophysical industry's rugged environments, the Amphenol® RPT Series connector has custom features that provide reliability in extreme temperature and moisture conditions.

The unique shell design provides stronger shells along with an anodized (non-conductive) finish for greater salt, corrosion and abrasion resistance. Coupling nuts are manufactured with round detent holes and are sold separately for greater customer flexibility. See product data sheet #146.



## RJ Field Bayonet Cylindricals

Amphenol PCD division provides MIL-DTL-26482 bayonet coupling cylindrical connectors with an RJ45 Ethernet interface\*. These are designed for use in all levels of harsh environments from industrial to mil-aero applications providing IP67 protection from dust, fluids, vibration, shock and traction. The Amphenol® RJ Field allows the use of Ethernet Class D/Cat 5 and Cat 5e connections for 10 BaseT, 100 Base TX, or 1000 BaseT networks. It works with any standard RJ45 cordset with no extra tooling. It also offers reinforced EMI protection.

For more information go online to [www.rjfield.com](http://www.rjfield.com) or ask for the Field Series brochure.

\* RJ Field Bayonet and other Field Series products are available through Amphenol PCD. These include RJF TV within MIL-DTL-38999 Series III threaded coupling connectors, and RJF 544 within ECTA push-pull plastic shell coupling.



## X-ON Electronics

Largest Supplier of Electrical and Electronic Components

*Click to view similar products for [Circular MIL Spec Connector](#) category:*

*Click to view products by [Amphenol](#) manufacturer:*

Other Similar products are found below :

[89075GULPR](#) [0025-262-542](#) [0025-264-3014](#) [58-570121-04S](#) [0134-213-1208](#) [0134-213-2209](#) [0025-258-000](#) [60-042022-07P](#) [60-042022-19P](#)  
[60-042022-23P](#) [60-042217-10P](#) [0114-201-1278](#) [012-0467-000](#) [602GB06EG24-61SN](#) [0134-201-1207](#) [0134-213-1006](#) [6104-207-2302](#) [6104-](#)  
[208-1902](#) [61-168211-04P](#) [61-168617-10P](#) [6131-202-19149P](#) [6131-204-21149P](#) [6131-208-13149P](#) [6131-209-17149P](#) [6131-210-11149P](#) [6131-](#)  
[211-19149P](#) [6131-216-19149P](#) [6131-259-21149P](#) [6131-259-23149P](#) [6131-265-17149P](#) [6131-265-19149P](#) [CS3100A18-1P-472](#) [CS3100A-36-](#)  
[77P](#) [CS3101A-16-55P](#) [CS3102A-10SL-55P](#) [CS3102A-14S-58P](#) [CS3102A-32-17P](#) [CS3102A32-25S](#) [CS3102C18-4P-472](#)  
[CS3106A10SL3S004](#) [CS3106A-18-73S](#) [CS3108A-14S-52S](#) [CS3108A-28-51S](#) [6162-233-1277](#) [6162-324-1231](#) [M243082296Z](#)  
[M2884010AC1S1](#) [CT0-24-10SC](#) [CT0M20-7PCAU](#) [M28840/17AC1G3](#)