

NPN SILICON PLANAR SWITCHING TRANSISTORS

PN2222/PN2222A

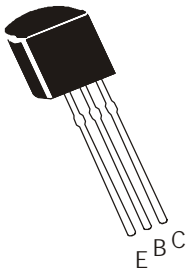

**TO-92
Plastic Package**
For Lead Free Parts, Device Part #
will be Prefixed with "T"

**Complementary Silicon Transistors For Switching And Linear Applications
DC Amplifier & Driver For Industrial Applications.**

ABSOLUTE MAXIMUM RATINGS(Ta=25deg C unless otherwise specified)

DESCRIPTION	SYMBOL	2222	2222A	UNIT
Collector -Emitter Voltage	VCEO	30	40	V
Collector -Base Voltage	VCBO	60	75	V
Emitter -Base Voltage	VEBO	5.0	6.0	V
Collector Current Continuous	IC		600	mA
Power Dissipation @Ta=25 degC	PD		625	mW
Derate Above 25deg C			5	mW/deg C
@ Tc=25 degC	PD		1.5	W
Derate Above 25deg C			12	mW/deg C
Operating And Storage Junction Temperature Range	Tj, Tstg	-55 to +150		deg C
THERMAL RESISTANCE				
Junction to Case	Rth(j-c)		83.3	deg C/W
Junction to Ambient	Rth(j-a)		200	deg C/W

ELECTRICAL CHARACTERISTICS (Ta=25 deg C Unless Otherwise Specified)

DESCRIPTION	SYMBOL	TEST CONDITION	2222	2222A	UNIT
Collector -Emitter Voltage	VCEO	IC=10mA, IB=0	>30	>40	V
Collector -Base Voltage	VCBO	IC=10uA, IE=0	>60	>75	V
Emitter-Base Voltage	VEBO	IE=10uA, IC=0	>5.0	>6.0	V
Collector-Cut off Current	ICBO	VCB=50V, IE=0	<10	-	nA
		VCB=60V, IE=0	-	<10	nA
		Ta=150 deg C			
		VCB=50V, IE=0	<10	-	uA
		VCB=60V, IE=0	-	<10	uA
	ICEX	VCE=60V, VBE=3V	-	<10	nA
	ICEO	VCE=10V, IB=0	<10	<10	nA
Emitter-Cut off Current	IEBO	VEB=3V, IC=0	-	<10	nA
Base-Cut off Current	IBEX	VCE=60V, VBE=3V	-	<20	nA
Collector Emitter Saturation Voltage	VCE(Sat)*	IC=150mA, IB=15mA	<0.4	<0.3	V
		IC=500mA, IB=50mA	<1.6	<1.0	V
Base Emitter Saturation Voltage	VBE(Sat) *	IC=150mA, IB=15mA	<1.3	0.6-1.2	V
		IC=500mA, IB=50mA	<2.6	<2.0	V

PN2222/PN2222ARev_1 290606D

ELECTRICAL CHARACTERISTICS (Ta=25 deg C Unless Otherwise Specified)			PN2222, PN2222A			
DESCRIPTION	SYMBOL	TEST CONDITION	2222	2222A	UNIT	
DC Current Gain	hFE	IC=0.1mA, VCE=10V	>35	>35		
		IC=1mA, VCE=10V	>50	>50		
		IC=10mA, VCE=10V	>75	>75		
		IC=10mA, VCE=10V	-	>35		
		Ta=55 deg C				
		IC=150mA, VCE=10V	100-300	100-300		
		IC=150mA, VCE=1V	>50	>50		
		IC=500mA, VCE=10V	>30	>40		
DYNAMIC CHARACTERISTICS						
Small Signal Current Gain	hfe	ALL f=1kHz				
		IC=1mA, VCE=10V	-	50-300		
Input Impedence	hie	IC=10mA, VCE=10V	-	75-375		
		IC=1mA, VCE=10V	-	2.0-8.0	kohms	
Voltage Feedback Ratio	hre	IC=10mA, VCE=10V	-	0.25-1.25		
		IC=1mA, VCE=10V	-	8.0 x 10 ⁻⁴		
Out put Adimttance	hoe	IC=10mA, VCE=10V	-	4.0		
		IC=1mA, VCE=10V	-	5.0-35	umhos	
Collector Base Time Constant	rb' Cc	IC=10mA, VCE=10V	-	25-200		
		IE=20mA, VCB=20V	-	<150	ps	
Noise Figure	NF	f=31.8MHz				
		IC=100uA, VCE=10V	-	<4.0	dB	
		Rs=1kohms, f=1kHz				
DYNAMIC CHARACTERISTICS						
Transistors Frequency	ft	IC=20mA, VCE=20V	>250	>300	MHz	
Out-Put Capacitance	Cob	f=100MHz				
		VCB=10V, IE=0	<8.0	<8.0	pF	
Input Capacitance	Cib	f=1MHz				
		VEB=0.5V, IC=0	<30	<25	pF	
		f=1MHz				
SWITCHING Time						
Delay time	td	IC=150mA, IB1=15mA		<10	ns	
Rise time	tr	VCC=30V, VBE=0.5V	-	<25	ns	
Storage time	ts	IC=150mA, IB1=		<225	ns	
Fall time	tf	IB2=15mA, VCC=30V	-	<60	ns	

*Pulse Condition: Length =300us, Duty Cycle=2%

PN2222/PN2222ARev_1 290606D

TO-92 Leaded Plastic Package

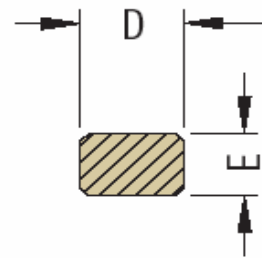
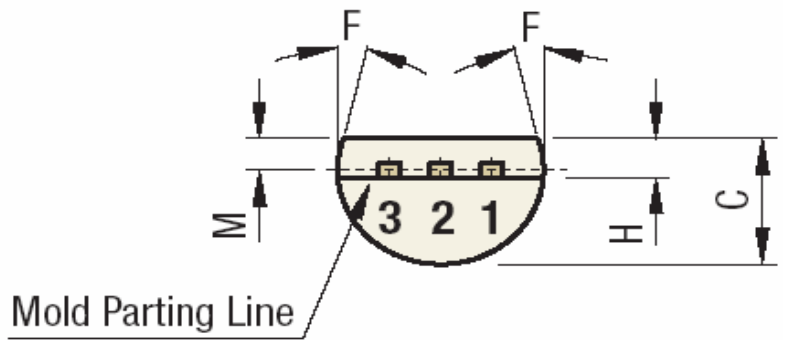
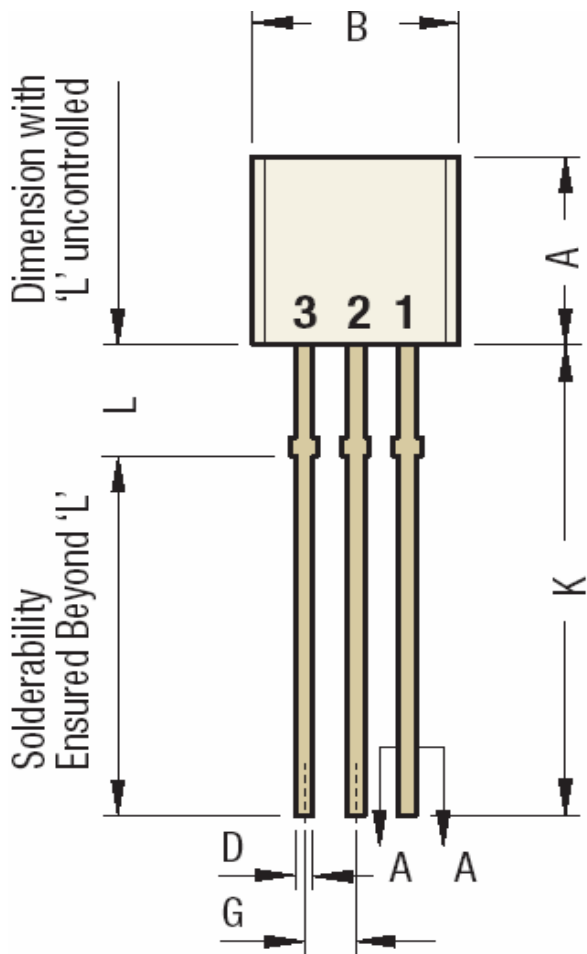

DIM	Min	Max
A	4.32	5.33
B	4.45	5.20
C	3.18	4.19
D	0.40	0.55
E	0.30	0.55
F	5°	

All Dimensions are in mm

DIM	Min	Max
G	1.14	1.40
H	1.20	1.40
K	12.7	
L	1.982	2.082
M	1.03	1.20

- Pin 1 Collector
- Pin 2 Base
- Pin 3 Emitter

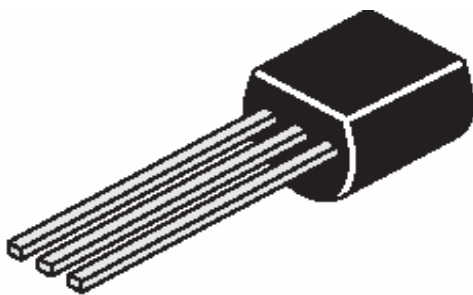

TO-92 Tape and Ammo Packaging

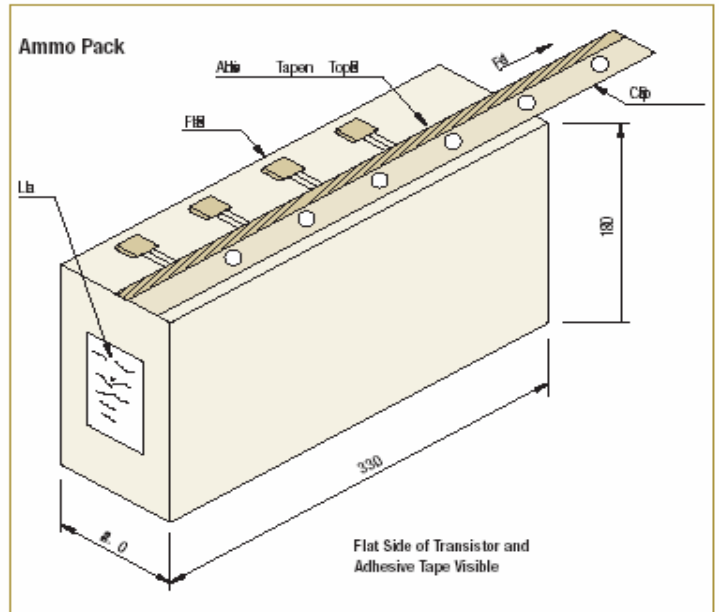
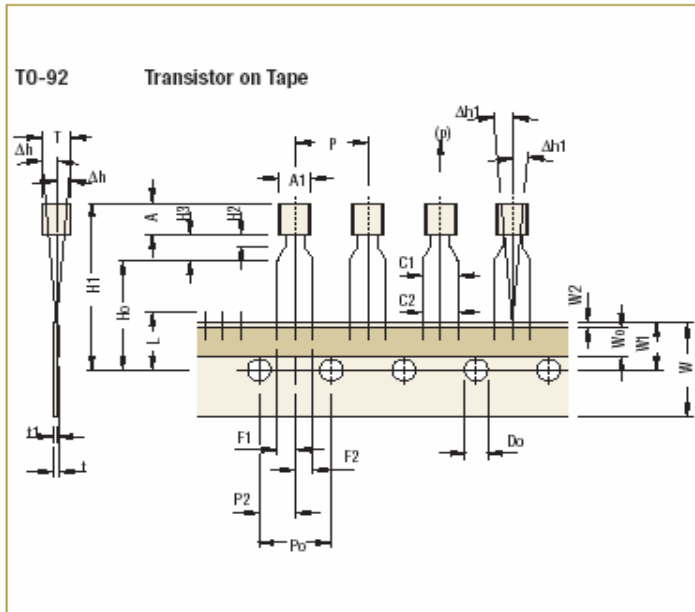

All Dimensions are in mm

Tape Specifications

Item description	Symbol	TO-92			
		Min	Nom	Max	Tol
Body width	A1	4.45		5.20	
Body height	A	4.32		5.33	
Body thickness	T	3.18		4.19	
Pitch of component ^{Cr}	P		12.7		±1.0
Feed hole pitch ^{§1}	Po		12.7		±0.3
Feed hole center to component centre ^{§2}	P2		6.35		±0.4
Comp. alignment, Side view ^{§3}	Dh		0	1.0	
Comp. alignment, Front view ^{§3}	Dh1		0	1.3	
Tape width ^{Cr}	W		18		±0.5
Hold down tape width ^{Cr}	W0		6		±0.2
Hole position	W1		9		+0.7 -0.5
Hold-down tape position	W2	0.0		0.7	
Lead wire clinch height	Ho		16		±0.5
Component height	H1			24.0	
Length of snipped leads	L			11.0	
Feed hole diameter ^{Cr}	Do		4		±0.2
Total tape thickness ^{§4}	t			1.2	
Lead-to-lead distance ^{Cr}	F1, F2	2.4		2.7	
Stand off	H2	0.45		1.45	
Clinch height	H3			3.0	
Lead parallelism ^{Cr}	C1-C2			0.22	
Pull-out force	(p)	6N			

All Dimensions are in mm

Taping Specification

- Maximum alignment deviation between leads not to be greater than 0.20 mm.
- Maximum non-cumulative variation between tape feed holes shall not exceed 1 mm in 20 pitches.
- Hold down tape not to exceed beyond the edge(s) carrier tape and there shall be no exposure of adhesive.
- No more than 3 consecutive missing components is permitted.
- A tape trailer, having at least three feed holes is required after the last component.
- Splices shall not interfere with the sprocket feed holes.

§1 Cumulative pitch error 1.0 mm/20 pitch.

§2 To be measured at bottom of clinch.

§3 At top of body.

§4 t1 = 0.3 – 0.6 mm

Cr Critical Dimension.

Packaging Information

T & A: Tape and Ammo Pack; T & R: Tape and Red; Bulk: Loose in Poly bags; Tube: Tube and Ammo Pack; k: 1.000

Package/Case Type	Packaging Type	Std. Packing		Inner Carton		Outer Carton		
		Qty	Qty	Size L x W x H (cm)	Gross Weight (Kg)	Qty	Size L x W x H (cm)	Gross Weight (Kg)
TO-92	Bulk	1,000	5K	19x19x8	1.10	80K	43x40x35	20.0
	T&A	2,000	2K	32x4.5x20	0.70	40K	43x40x35	15.20

Component Disposal Instructions

1. CDIL Semiconductor Devices are RoHS compliant, customers are requested to please dispose as per prevailing Environmental Legislation of their Country.
2. In Europe, please dispose as per EU Directive 2002/96/EC on Waste Electrical and Electronic Equipment (WEEE).

Customer Notes

Disclaimer

The product information and the selection guides facilitate selection of the CDIL's Semiconductor Device(s) best suited for application in your product(s) as per your requirement. It is recommended that you completely review our Data Sheet(s) so as to confirm that the Device(s) meet functionality parameters for your application. The information furnished in the Data Sheet and on the CDIL Web Site/CD are believed to be accurate and reliable. CDIL however, does not assume responsibility for inaccuracies or incomplete information. Furthermore, CDIL does not assume liability whatsoever, arising out of the application or use of any CDIL product; neither does it convey any license under its patent rights nor rights of others. These products are not designed for use in life saving/support appliances or systems. CDIL customers selling these products (either as individual Semiconductor Devices or incorporated in their end products), in any life saving/support appliances or systems or applications do so at their own risk and CDIL will not be responsible for any damages resulting from such sale(s). CDIL strives for continuous improvement and reserves the right to change the specifications of its products without prior notice.



CDIL is a registered Trademark of
Continental Device India Limited

C-120 Naraina Industrial Area, New Delhi 110 028, India.

Telephone + 91-11-2579 6150, 4141 1112 Fax + 91-11-2579 5290, 4141 1119
email@cdil.com www.cdilsemi.com

X-ON Electronics

Largest Supplier of Electrical and Electronic Components

Click to view similar products for [Bipolar Transistors - BJT category](#):

Click to view products by [CDIL manufacturer](#):

Other Similar products are found below :

[619691C](#) [MCH4017-TL-H](#) [MJ15024/WS](#) [MJ15025/WS](#) [BC546/116](#) [BC556/FSC](#) [BC557/116](#) [BSW67A](#) [HN7G01FU-A\(T5L,F,T](#)
[NJVMJD148T4G](#) [NSVMMBT6520LT1G](#) [NTE187A](#) [NTE195A](#) [NTE2302](#) [NTE2330](#) [NTE2353](#) [NTE316](#) [IMX9T110](#) [NTE63](#) [NTE65](#)
[C4460](#) [SBC846BLT3G](#) [2SA1419T-TD-H](#) [2SA1721-O\(TE85L,F\)](#) [2SA1727TLP](#) [2SA2126-E](#) [2SB1202T-TL-E](#) [2SB1204S-TL-E](#) [2SC5488A-](#)
[TL-H](#) [2SD2150T100R](#) [SP000011176](#) [FMC5AT148](#) [2N2369ADCSM](#) [2SB1202S-TL-E](#) [2SC2412KT146S](#) [2SC4618TLN](#) [2SC5490A-TL-H](#)
[2SD1816S-TL-E](#) [2SD1816T-TL-E](#) [CMXT2207 TR](#) [CPH6501-TL-E](#) [MCH4021-TL-E](#) [BC557B](#) [TTC012\(Q\)](#) [BULD128DT4](#) [JANTX2N3810](#)
[Jantx2N5416](#) [US6T6TR](#) [KSF350](#) [068071B](#)