

IGBT Module

Short Circuit SOA Capability
Square RBSOA

PSHI 25/12*

$I_{C25} = 30 \text{ A}$
 $V_{CES} = 1200 \text{ V}$
 $V_{CE(sat)typ.} = 2.6 \text{ V}$

Preliminary Data Sheet

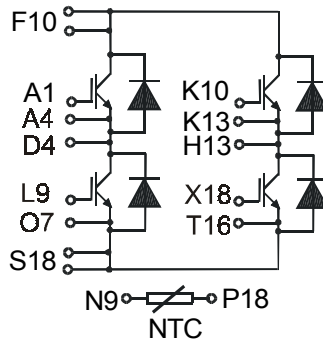

*NTC optional

IGBTs

Symbol	Conditions	Maximum Ratings
V_{CES}	$T_{VJ} = 25^\circ\text{C to } 150^\circ\text{C}$	1200 V
V_{GES}		± 20 V
I_{C25}	$T_C = 25^\circ\text{C}$	30 A
I_{C80}	$T_C = 80^\circ\text{C}$	21 A
I_{CM} V_{CEK}	$V_{GE} = \pm 15 \text{ V}; R_G = 82 \Omega; T_{VJ} = 125^\circ\text{C}$ RBSOA, Clamped inductive load; $L = 100 \mu\text{H}$	35 V_{CES} A
t_{SC} (SCSOA)	$V_{CE} = V_{CES}; V_{GE} = \pm 15 \text{ V}; R_G = 82 \Omega; T_{VJ} = 125^\circ\text{C}$ non-repetitive	10 μs
P_{tot}	$T_C = 25^\circ\text{C}$	130 W

PSHI 25/12*

Features

- NPT IGBT technology
- low saturation voltage
- low switching losses
- square RBSOA, no latch up
- high short circuit capability
- positive temperature coefficient for easy paralleling
- MOS input, voltage controlled
- ultra fast free wheeling diodes
- solderable pins for PCB mounting
- package with copper base plate
- Isolation voltage 3000 V~
- UL registered, E 148688

Advantages

- space and weight savings
- reduced protection circuits
- package designed for wave soldering
- High power density
- Easy to mount with two screws

Typical Applications

- motor control
 - DC motor armature winding
 - DC motor excitation winding
 - synchronous motor excitation winding
- supply of transformer primary winding
 - power supplies
 - welding
 - X-ray
 - UPS
 - battery charger

Symbol	Conditions	Characteristic Values ($T_{VJ} = 25^\circ\text{C}$, unless otherwise specified)			
		min.	typ.	max.	
$V_{CE(sat)}$	$I_C = 25 \text{ A}; V_{GE} = 15 \text{ V}; T_{VJ} = 25^\circ\text{C}$ $T_{VJ} = 125^\circ\text{C}$		2.6 2.9	3.3 V V	
$V_{GE(th)}$	$I_C = 0.6 \text{ mA}; V_{GE} = V_{CE}$	4.5		6.5 V	
I_{CES}	$V_{CE} = V_{CES}; V_{GE} = 0 \text{ V}; T_{VJ} = 25^\circ\text{C}$ $T_{VJ} = 125^\circ\text{C}$			0.9 mA 3.7 mA	
I_{GES}	$V_{CE} = 0 \text{ V}; V_{GE} = \pm 20 \text{ V}$			100 nA	
$t_{d(on)}$ t_r $t_{d(off)}$ t_f	Inductive load, $T_{VJ} = 125^\circ\text{C}$ $V_{CE} = 600 \text{ V}; I_C = 17.5 \text{ A}$ $V_{GE} = 15/0 \text{ V}; R_G = 82 \Omega$		100 75 500 70	ns ns ns ns	
E_{on} E_{off}			2.7 2.1	mJ mJ	
C_{ies}		$V_{CE} = 25 \text{ V}; V_{GE} = 0 \text{ V}; f = 1 \text{ MHz}$		1	nF
R_{thJC} R_{thJH}		(per IGBT) with heatsink compound (0.42 K/m.K; 50 μm)		1.92	0.96 K/W K/W

Caution: These Devices are sensitive to electrostatic discharge. Users should observe proper ESD handling precautions.

Reverse diodes (FRED)

Symbol	Conditions	Maximum Ratings	
I_{F25}	$T_C = 25^\circ\text{C}$	26	A
I_{F80}	$T_C = 80^\circ\text{C}$	17	A

Symbol	Conditions	Characteristic Values		
		min.	typ.	max.
V_F	$I_F = 17.5\text{ A}; T_{VJ} = 25^\circ\text{C}$ $T_{VJ} = 125^\circ\text{C}$	2.48	2.79	V
I_{RM} t_{rr}	$I_F = 15\text{ A}; di_F/dt = 400\text{ A}/\mu\text{s}; T_{VJ} = 125^\circ\text{C}$ $V_R = 600\text{ V}; V_{GE} = 0\text{ V}$	16		A
R_{thJC} R_{thJH}	with heatsink compound (0.42 K/m.K; 50 μm)	4.6	2.3	K/W

Temperature Sensor NTC

Symbol	Conditions	Characteristic Values		
		min.	typ.	max.
R_{25}	$T = 25^\circ\text{C}$	4.75	5.0	k Ω
$B_{25/50}$			3375	K

Module

Symbol	Conditions	Maximum Ratings	
T_{VJ}		-40...+150	$^\circ\text{C}$
T_{stg}		-40...+150	$^\circ\text{C}$
V_{ISOL}	$I_{ISOL} \leq 1\text{ mA}; 50/60\text{ Hz}$	3000	V~
M_d	Mounting torque (M4)	1.5 - 2.0	Nm
		14 - 18	lb.in.
a	Max. allowable acceleration	50	m/s^2

Symbol	Conditions	Characteristic Values		
		min.	typ.	max.
d_s	Creepage distance on surface (Pin to heatsink)	11.2		mm
d_A	Strike distance in air (Pin to heatsink)	11.2		mm
Weight		24		g

Package style and outline

Dimensions in mm (1mm = 0.0394")

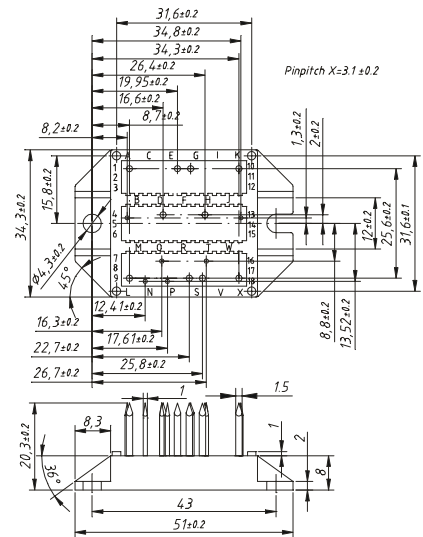

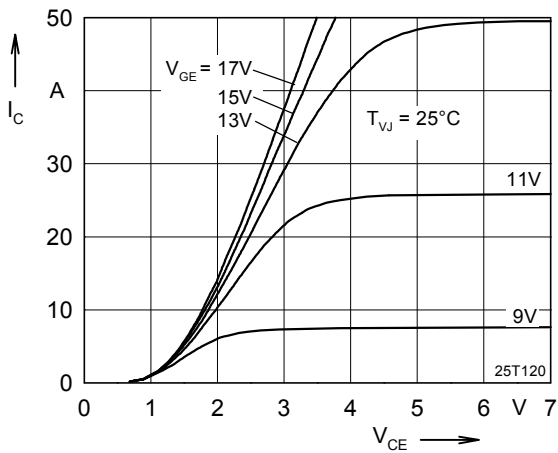

Fig. 1 Typ. output characteristics

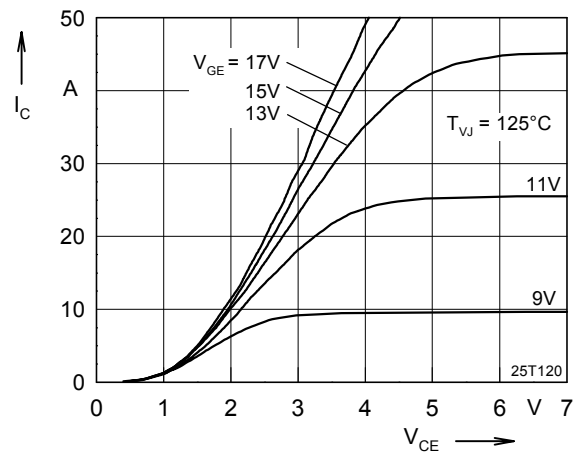

Fig. 2 Typ. output characteristics

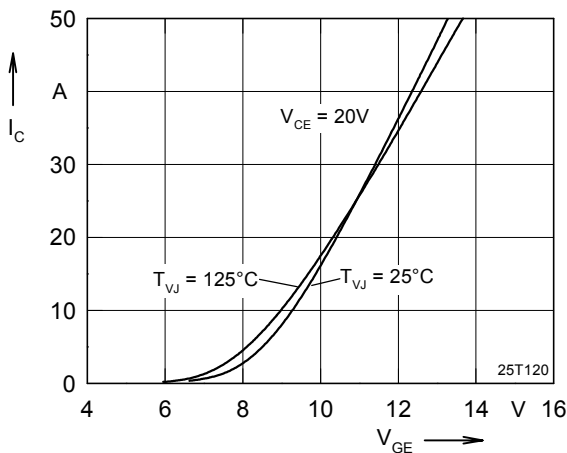

Fig. 3 Typ. transfer characteristics

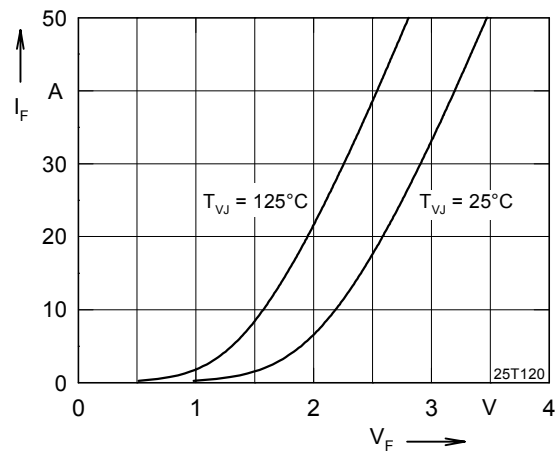

Fig. 4 Typ. forward characteristics of free wheeling diode

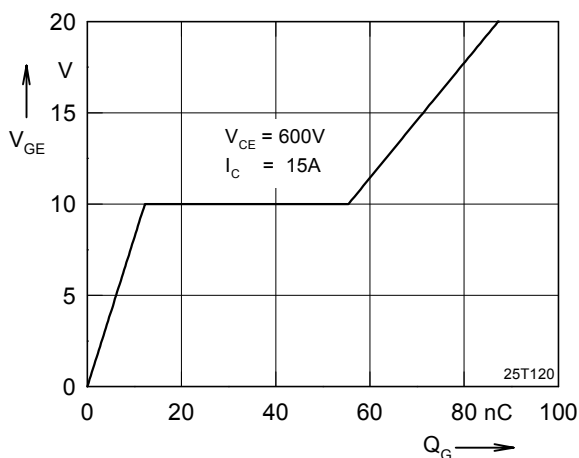

Fig. 5 Typ. turn on gate charge

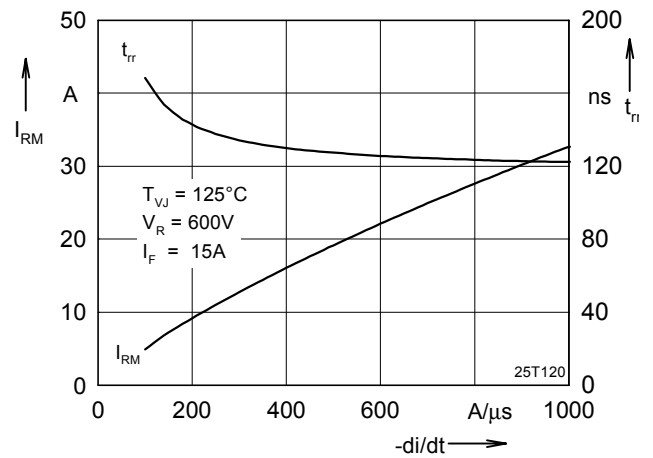

Fig. 6 Typ. turn off characteristics of free wheeling diode

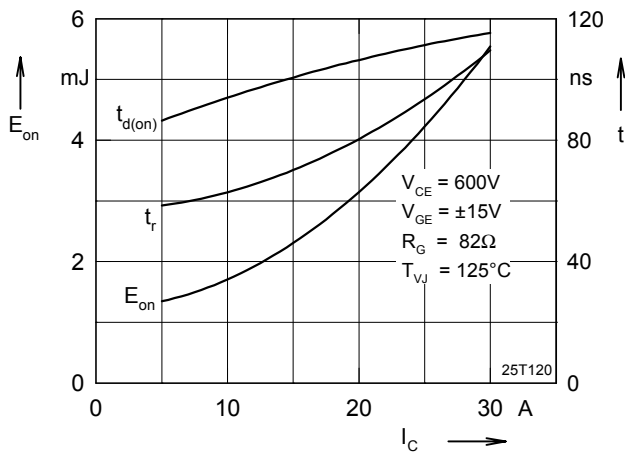

Fig. 7 Typ. turn on energy and switching

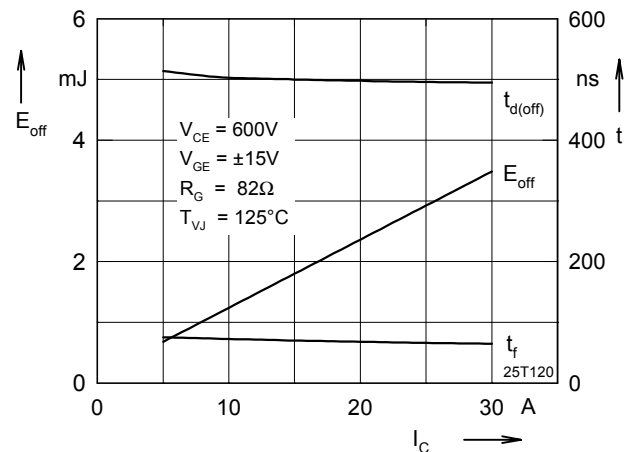

Fig. 8 Typ. turn off energy and switching times versus collector current times versus collector current

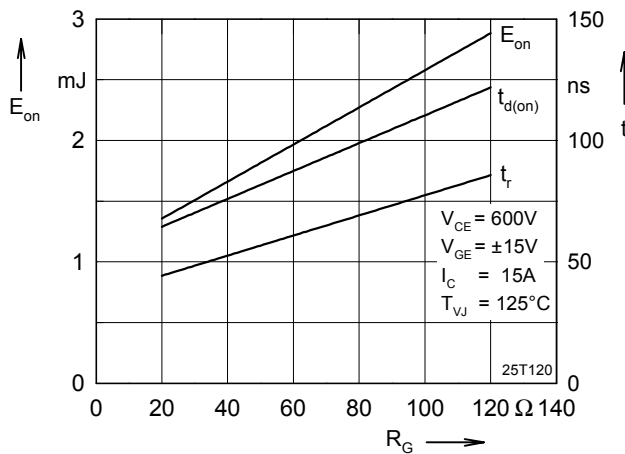

Fig. 9 Typ. turn on energy and switching

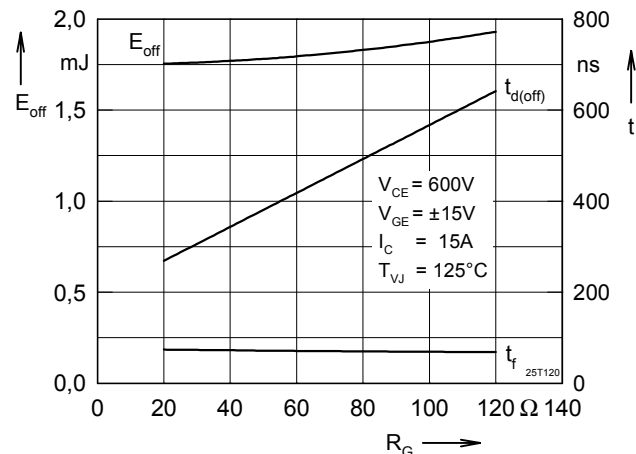

Fig. 10 Typ. turn off energy and switching times versus gate resistor times versus gate resistor

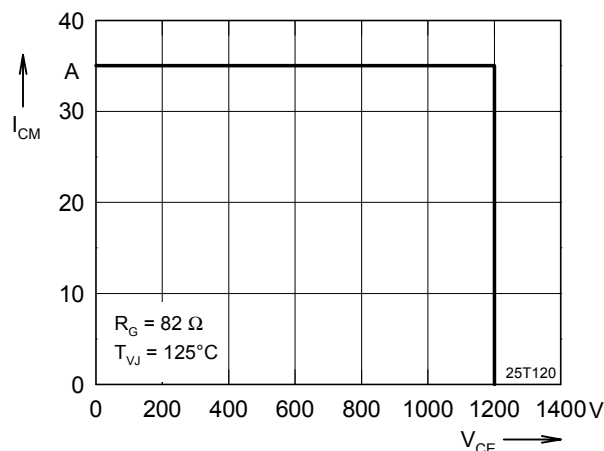

Fig. 11 Reverse biased safe operating area

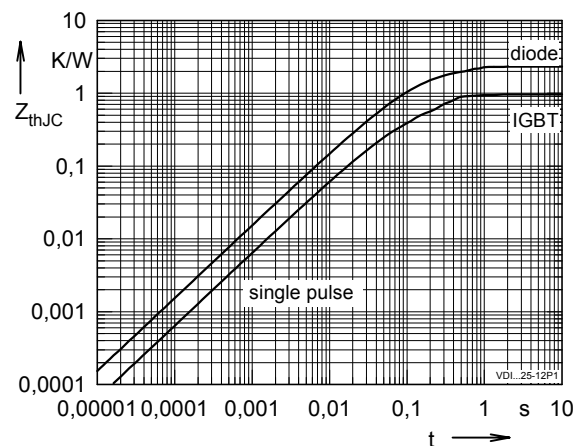

Fig. 12 Typ. transient thermal impedance RBSOA

X-ON Electronics

Largest Supplier of Electrical and Electronic Components

Click to view similar products for [IGBT Modules category](#):

Click to view products by [Powersem manufacturer](#):

Other Similar products are found below :

[F3L100R07W2E3_B11](#) [F3L15R12W2H3_B27](#) [F3L400R07ME4_B22](#) [F3L400R12PT4_B26](#) [F4-100R12KS4](#) [F4-50R07W2H3_B51](#) [F4-75R12KS4_B11](#) [FB15R06W1E3](#) [FB20R06W1E3_B11](#) [FD1000R33HE3-K](#) [FD200R12KE3](#) [FD300R06KE3](#) [FD300R12KE3](#) [FD300R12KS4_B5](#) [FD400R12KE3](#) [FD400R33KF2C-K](#) [FD401R17KF6C_B2](#) [FD-DF80R12W1H3_B52](#) [FF100R12KS4](#) [FF1200R17KE3_B2](#) [FF150R12KE3G](#) [FF200R06KE3](#) [FF200R06YE3](#) [FF200R12KT3](#) [FF200R12KT3_E](#) [FF200R12KT4](#) [FF200R17KE3](#) [FF300R06KE3_B2](#) [FF300R12KE4_E](#) [FF300R12KS4HOSA1](#) [FF300R12ME4_B11](#) [FF300R12MS4](#) [FF300R17ME4](#) [FF450R12ME4P](#) [FF450R17IE4](#) [FF600R12IE4V](#) [FF600R12IP4V](#) [FF800R17KE3](#) [FF800R17KP4_B2](#) [FF900R12IE4V](#) [MIXA30W1200TED](#) [FP06R12W1T4_B3](#) [FP100R07N3E4](#) [FP100R07N3E4_B11](#) [FP10R06W1E3_B11](#) [FP10R12W1T4_B11](#) [FP10R12YT3](#) [FP10R12YT3_B4](#) [FP150R07N3E4](#) [FP15R12KT3](#)