

IGBT Module PSII 35/06 Sixpack

Preliminary Data Sheet

$$I_{C25} = 31 \text{ A}$$

$$V_{CES} = 600 \text{ V}$$

$$V_{CE(sat)typ.} = 1.9 \text{ V}$$

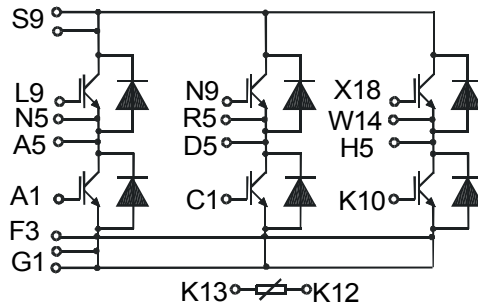

PSII 35/06

IGBTs

Symbol	Conditions	Maximum Ratings	
V_{CES}	$T_{VJ} = 25^{\circ}\text{C to } 150^{\circ}\text{C}$	600	V
V_{GES}		± 20	V
I_{C25}	$T_C = 25^{\circ}\text{C}$	31	A
I_{C80}	$T_C = 80^{\circ}\text{C}$	21	A
I_{CM} V_{CEK}	$V_{GE} = \pm 15 \text{ V}; R_G = 47 \Omega; T_{VJ} = 125^{\circ}\text{C}$ RBSOA, Clamped inductive load; $L = 100 \mu\text{H}$	40	A
t_{SC} (SCSOA)		$V_{CE} = 600 \text{ V}; V_{GE} = \pm 15 \text{ V}; R_G = 47 \Omega; T_{VJ} = 125^{\circ}\text{C}$ non-repetitive	10
P_{tot}	$T_C = 25^{\circ}\text{C}$	100	W

Features

- NPT IGBT's
 - positive temperature coefficient of saturation voltage
 - fast switching
- FRED diodes
 - fast reverse recovery
 - low forward voltage
- Industry Standard Package
 - solderable pins for PCB mounting
 - isolated DCB ceramic base plate
- UL registered, E 148688

Applications

- AC drives
- power supplies with power factor correction

Advantages

- Easy to mount with two screws
- Space and weight savings
- Improved temperature and power cycling capability
- High power density
- Small and light weight

Symbol	Conditions	Characteristic Values ($T_{VJ} = 25^{\circ}\text{C}$, unless otherwise specified)		
		min.	typ.	max.
$V_{CE(sat)}$	$I_C = 20 \text{ A}; V_{GE} = 15 \text{ V}; T_{VJ} = 25^{\circ}\text{C}$ $T_{VJ} = 125^{\circ}\text{C}$		1.9 2.2	2.4 V
$V_{GE(th)}$	$I_C = 0.5 \text{ mA}; V_{GE} = V_{CE}$	4.5		6.5 V
I_{CES}	$V_{CE} = V_{CES}; V_{GE} = 0 \text{ V}; T_{VJ} = 25^{\circ}\text{C}$ $T_{VJ} = 125^{\circ}\text{C}$		0.7	0.6 mA mA
I_{GES}	$V_{CE} = 0 \text{ V}; V_{GE} = \pm 20 \text{ V}$			100 nA
$t_{d(on)}$ t_r $t_{d(off)}$ t_f E_{on} E_{off}	Inductive load, $T_{VJ} = 125^{\circ}\text{C}$ $V_{CE} = 300 \text{ V}; I_C = 10 \text{ A}$ $V_{GE} = \pm 15 \text{ V}; R_G = 82 \Omega$		50 55	ns ns
				300 30
			0.9 0.7	mJ mJ
C_{ies}	$V_{CE} = 25 \text{ V}; V_{GE} = 0 \text{ V}; f = 1 \text{ MHz}$		1100	pF
Q_{Gon}	$V_{CE} = 300 \text{ V}; V_{GE} = 15 \text{ V}; I_C = 20 \text{ A}$		65	nC
R_{thJC} R_{thJH}	(per IGBT) with heatsink compound ($0.42 \text{ K/m.K}; 50 \mu\text{m}$)		2.5	1.3 K/W K/W

Caution: These devices are sensitive to electrostatic discharge. Users should observe proper ESD handling precautions.

Diodes

Symbol	Conditions	Maximum Ratings	
I_{F25}	$T_C = 25^\circ\text{C}$	35	A
I_{F80}	$T_C = 80^\circ\text{C}$	22	A

Symbol	Conditions	Characteristic Values		
		min.	typ.	max.
V_F	$I_F = 20\text{ A}; T_{VJ} = 25^\circ\text{C}$ $T_{VJ} = 125^\circ\text{C}$	1.9	2.1	V
I_{RM} t_{rr}	$I_F = 15\text{ A}; di_F/dt = -400\text{ A}/\mu\text{s}; T_{VJ} = 125^\circ\text{C}$ $V_R = 300\text{ V}; V_{GE} = 0\text{ V}$	13		A
R_{thJC} R_{thJH}	with heatsink compound (0.42 K/m.K; 50 μm)	4.6		ns
				2.3 K/W
				K/W

Data according to IEC 60747 and refer to a single diode unless otherwise stated.

Component

Symbol	Conditions	Maximum Ratings	
T_{VJ}		-40...+150	$^\circ\text{C}$
T_{stg}		-40...+125	$^\circ\text{C}$
V_{ISOL}	$I_{ISOL} \leq 1\text{ mA}; 50/60\text{ Hz}; t = 1\text{ s}$	3600	V~
M_d	Mounting torque (M4)	1.5 - 2.0	Nm
		14 - 18	lb.in.
a	Max. allowable acceleration	50	m/s^2

Symbol	Conditions	Characteristic Values		
		min.	typ.	max.
d_s	Creepage distance on surface (Pin to heatsink)	11.2		mm
d_A	Strike distance in air (Pin to heatsink)	11.2		mm
Weight		24		g

Package style and outline

Dimensions in mm (1mm = 0.0394")

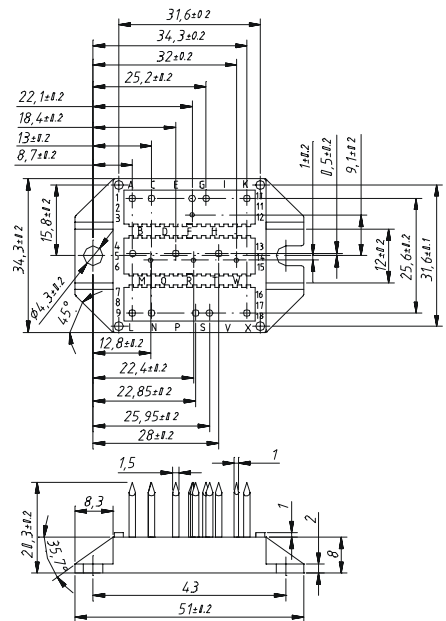

IGBT

Typ. output characteristics

$V_{GS} = 15 \text{ V}$

parameter: $t_{sw} = 250 \text{ ns}$, $T_c = 25^\circ \text{ C}$

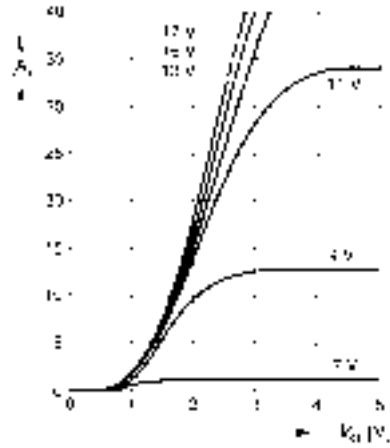

Typ. output characteristics

$I_c = 10 \text{ A}$

parameter: $t_{sw} = 250 \text{ ns}$, $T_c = 25^\circ \text{ C}$

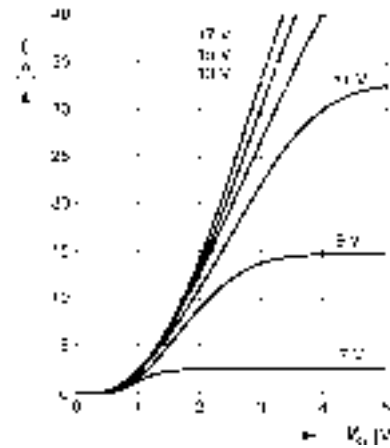

Typ. gate charge

$V_{ce} = 15 \text{ V}$

parameter: $I_{c,sw} = 20 \text{ A}$

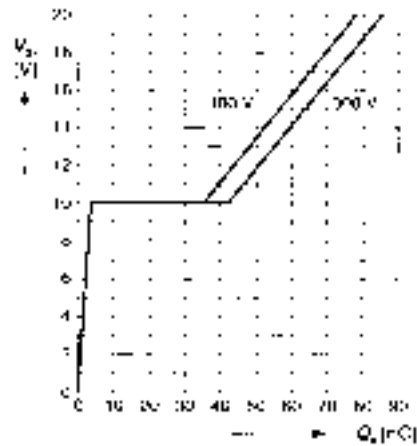

Typ. capacitances

$C = 10 \text{ V}$

parameter: $V_{ce} = 0 \text{ V}$, $f = 1 \text{ MHz}$

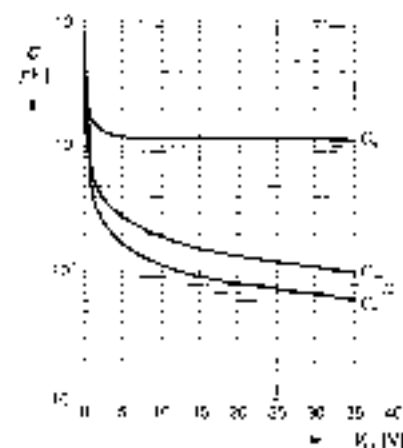

Reverse biased safe operating area

$I_{c,rev} = 10 \text{ A}$, $T_c = 25^\circ \text{ C}$

parameter: $V_{ce} = 15 \text{ V}$

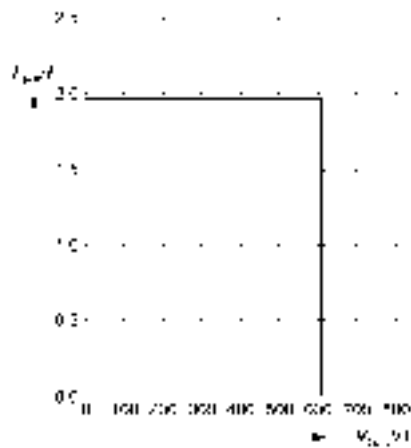

Short circuit safe operating area

$V_{ce} = 10 \text{ V}$, $T_c = 25^\circ \text{ C}$

parameter: $V_{gs} = 15 \text{ V}$, $t_{sc} = 10 \text{ us}$, $I_{c,sc} = 50 \text{ A}$

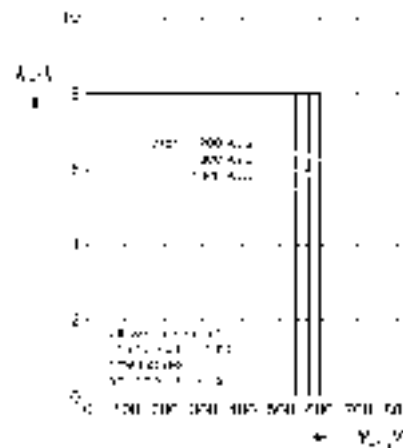

IGBT

Typ. switching time

$i = 10\text{ A}$, inductive load, $T_j = 125\text{ °C}$
 parameters: $V_{CE} = 300\text{ V}$, $V_{GE} = \pm 15\text{ V}$, $R_{\theta j-c} = 47\text{ mK/W}$

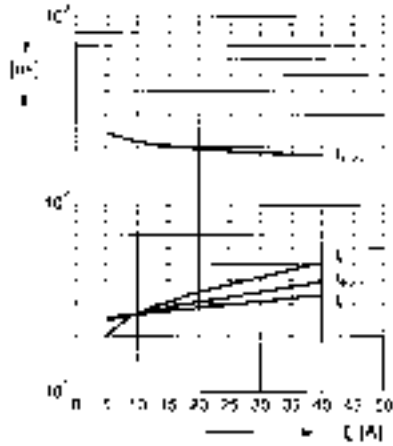

Typ. switching time

$i = 10\text{ A}$, inductive load, $T_j = 125\text{ °C}$
 parameters: $V_{CE} = 300\text{ V}$, $V_{GE} = \pm 15\text{ V}$, $I_C = 20\text{ A}$

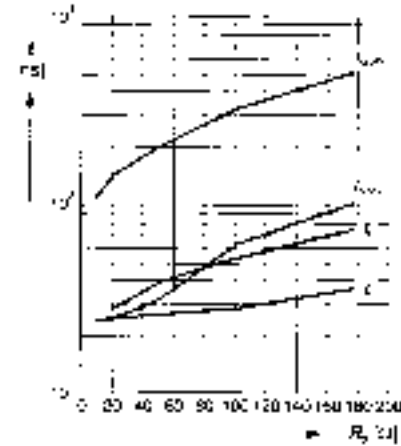

Typ. switching losses

$E = 10\text{ mJ}$, inductive load, $T_j = 125\text{ °C}$
 parameters: $V_{CE} = 300\text{ V}$, $V_{GE} = \pm 15\text{ V}$, $R_{\theta j-c} = 47\text{ mK/W}$

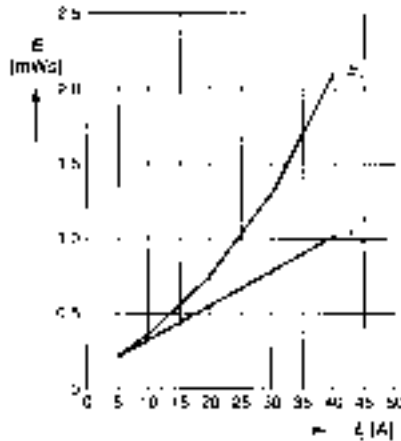

Typ. switching losses

$E = 10\text{ mJ}$, inductive load, $T_j = 125\text{ °C}$
 parameters: $V_{CE} = 300\text{ V}$, $V_{GE} = \pm 15\text{ V}$, $I_C = 20\text{ A}$

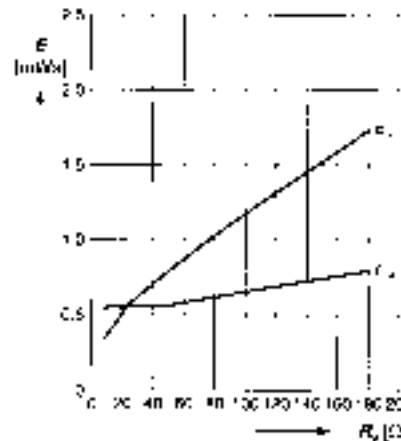

Transient thermal resistance junction to heatsink

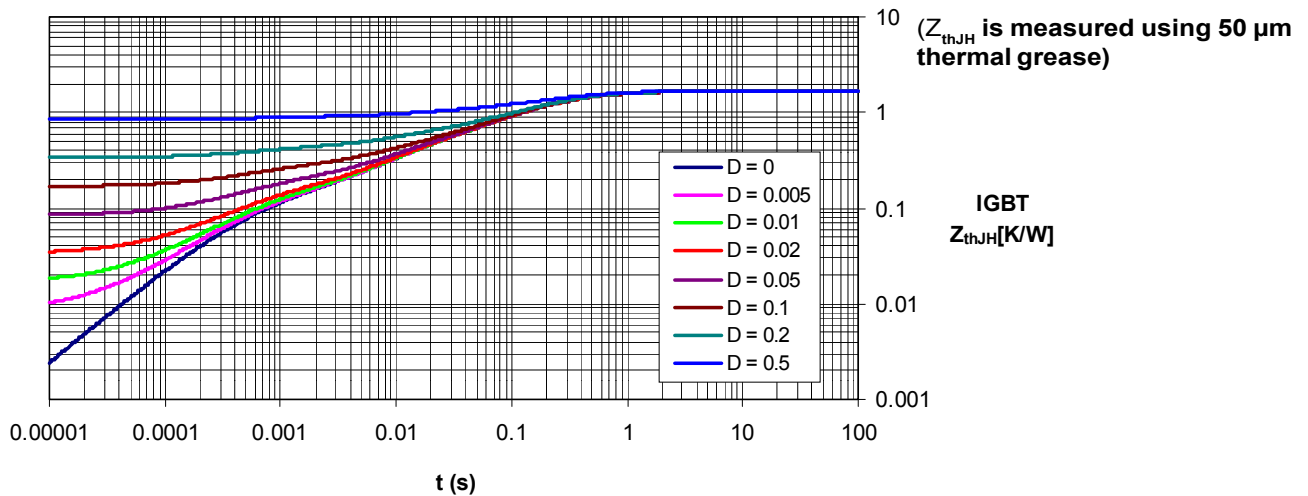

Diode

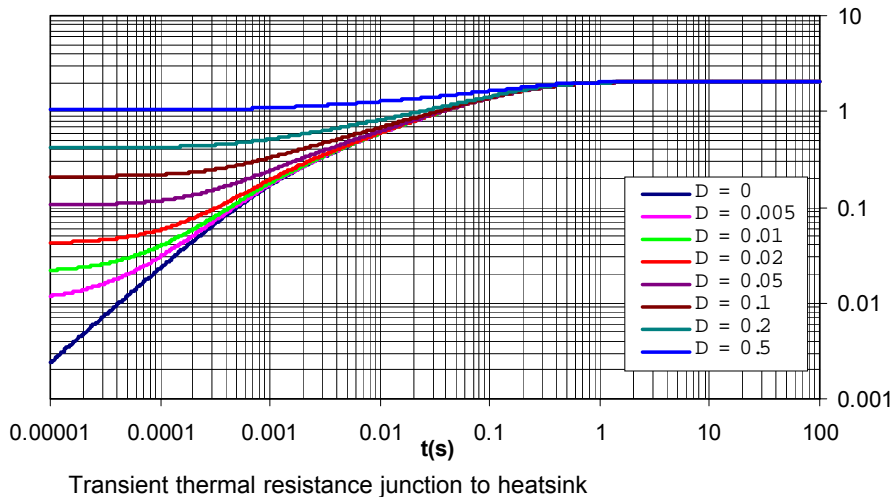
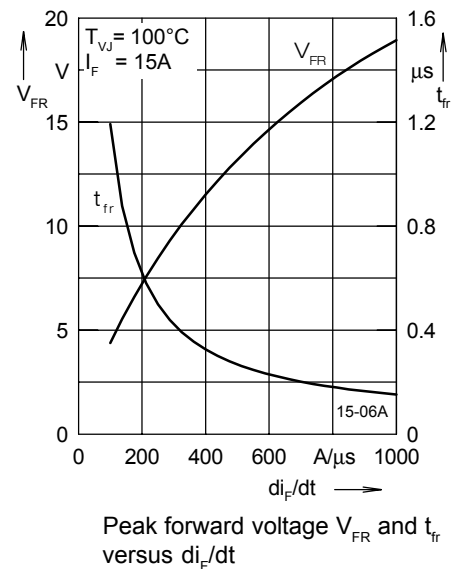
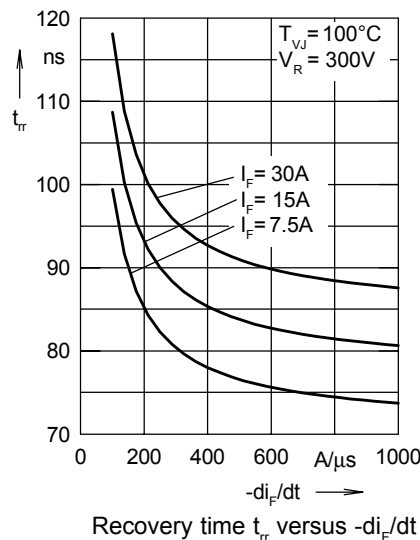
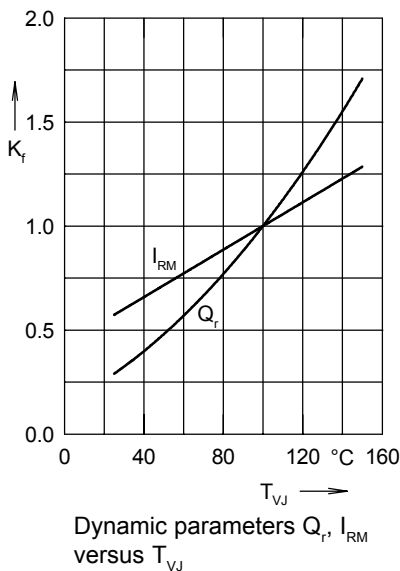
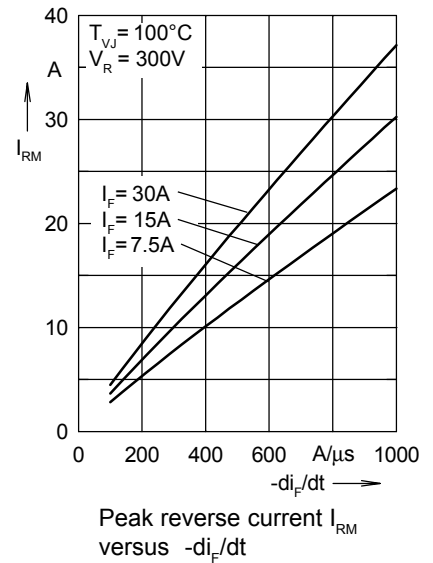
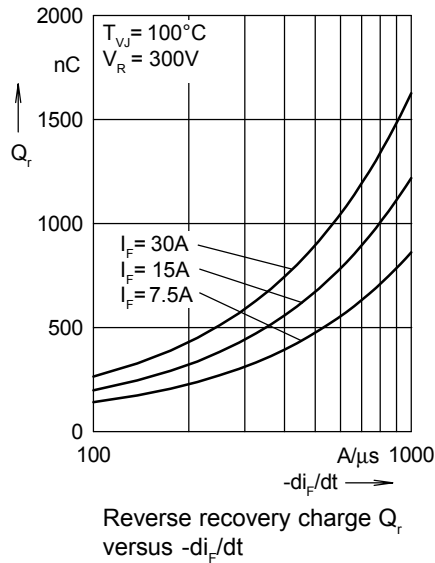
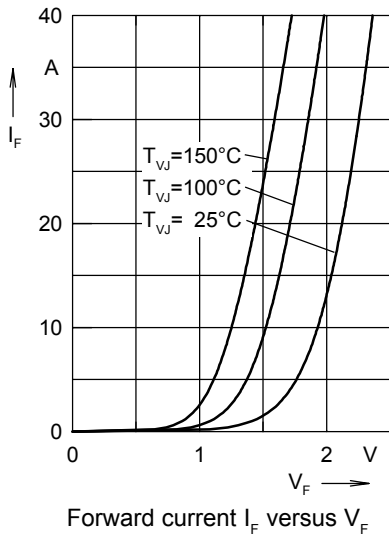

(Z_{thJH} is measured using 50 μm thermal grease)

FRED
 Z_{thJH} [K/W]

X-ON Electronics

Largest Supplier of Electrical and Electronic Components

Click to view similar products for [IGBT Modules category](#):

Click to view products by [Powersem manufacturer](#):

Other Similar products are found below :

[F3L100R07W2E3_B11](#) [F3L15R12W2H3_B27](#) [F3L400R07ME4_B22](#) [F3L400R12PT4_B26](#) [F4-100R12KS4](#) [F4-50R07W2H3_B51](#) [F4-75R12KS4_B11](#) [FB15R06W1E3](#) [FB20R06W1E3_B11](#) [FD1000R33HE3-K](#) [FD200R12KE3](#) [FD300R06KE3](#) [FD300R12KE3](#) [FD300R12KS4_B5](#) [FD400R12KE3](#) [FD400R33KF2C-K](#) [FD401R17KF6C_B2](#) [FD-DF80R12W1H3_B52](#) [FF100R12KS4](#) [FF1200R17KE3_B2](#) [FF150R12KE3G](#) [FF200R06KE3](#) [FF200R06YE3](#) [FF200R12KT3](#) [FF200R12KT3_E](#) [FF200R12KT4](#) [FF200R17KE3](#) [FF300R06KE3_B2](#) [FF300R12KE4_E](#) [FF300R12KS4HOSA1](#) [FF300R12ME4_B11](#) [FF300R12MS4](#) [FF300R17ME4](#) [FF450R12ME4P](#) [FF450R17IE4](#) [FF600R12IE4V](#) [FF600R12IP4V](#) [FF800R17KE3](#) [FF800R17KP4_B2](#) [FF900R12IE4V](#) [MIXA30W1200TED](#) [FP06R12W1T4_B3](#) [FP100R07N3E4](#) [FP100R07N3E4_B11](#) [FP10R06W1E3_B11](#) [FP10R12W1T4_B11](#) [FP10R12YT3](#) [FP10R12YT3_B4](#) [FP150R07N3E4](#) [FP15R12KT3](#)