



## Q-ties

### Innovative – Effective – Safe!

The new Q-tie has not only innovative, but also has a revolutionary new design. The open head of the cable tie enables a simple and quick installation. Simply insert the ergonomically bent tail into the open side of the head and tighten the cable tie.

With Q-ties you can save time and money!

### Easy Application for every Situation!

Q-tie provides the perfect solution for applications in difficult working conditions. It is ideal for use when working with gloves is necessary or for blind applications with a limited view of the work allowing for a quick and simple installation.

Features for quick and easy application:

- Large curved tail with easy-grip ribs
- Open head with easily detectable slot

This saves time and trouble!



*The head design makes the difference.*



*Even under difficult circumstances the Q-tie cable tie is very fast and easy to apply.*

### Integrated Pre-locking Functionality!

Due to several simultaneous working processes, it is not always possible to install all cables and conduits in one single step.

Using standard cable ties means either removing the cable tie of the first installation or applying additional cable ties. The integrated pre-locking function offers both a temporary and final cable fastening solution.

This saves material and time!



*Without additional effort only Q-ties can be used for temporary and final cable bundling.*



*Application video: Q-Series*

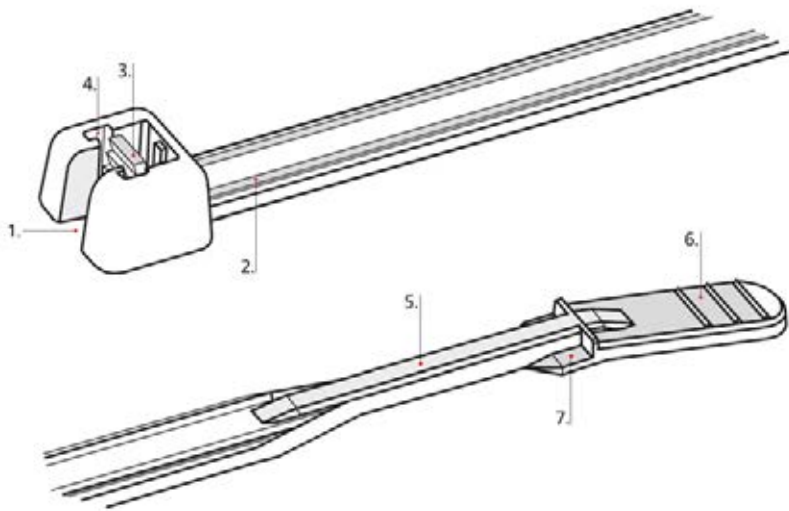
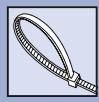

### Features of Q-ties:

1. Open lock head for quick and easy insertion.
2. Two rails on the strap ensure perfect guidance for the tracks in the head.
3. The locking device interacts safely with the serration of the cable tie.
4. The tracks prevent a deformation of the head under load.
5. The thin part of the cable tie can be simply placed into the open lock head.
6. The large ribbed tail allows a safe and ergonomic installation.
7. Integrated pre-locking feature (starts with type Q30).

### Application Method:



1. Insert the thin part of the cable tie into the open lock head.



2. Pull the tie through the head until the bundle is fixed.

3. Cut off the remaining part of the tie with an application tool.



Please find more Q-Series products for your system solution on page 134 and 459.

### Pre-Locking Function of the Q-tie:



1. Insert tail into the open head and push the tail partly into the head.

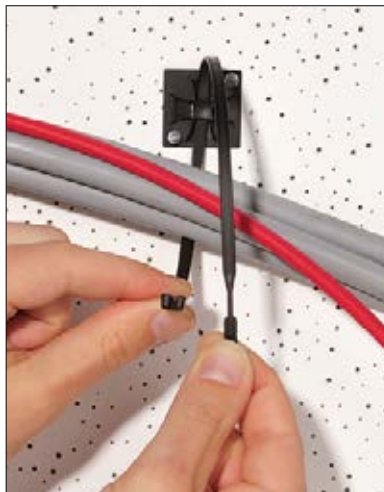

2. To release the tie push the tail slightly out of the head.



3. When the installation is complete, the Q-tie can be tightened and cut off - either manually or with an application tool.



## Cable Ties with open head Polyamide 6.6 standard

### Q-Series in PA66 natural and black

Q-Series cable ties for bundling and securing cables, pipes and hoses. These innovative and effective cable ties enable a simple and quick installation, even in difficult applications.

#### Features and Benefits

- Open lock head for quick and easy insertion
- Integrated pre-locking function
- More than 25 % faster to apply than a standard cable tie
- Inside serration for a strong hold around bundles
- Easy application either manually or with a processing tool



Q-tie cable ties: choose from a wide product range in different sizes.

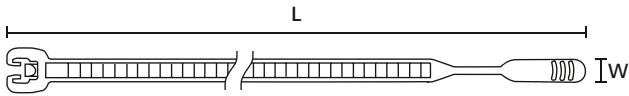

Q-Series

TYPE	Width (W)	Length (L)	Bundle Ø max.	N	Material	Colour	Pack Cont.	Tools	Article-No.
Q18R	2.6	105.0	24.0	80	PA66	Black (BK)	100 pcs.	2;4-6	109-00030
	2.6	105.0	24.0	80	PA66	Natural (NA)	100 pcs.	2;4-6	109-00001
Q18I	2.6	155.0	40.0	80	PA66	Black (BK)	100 pcs.	2;4-6	109-00033
	2.6	155.0	40.0	80	PA66	Natural (NA)	100 pcs.	2;4-6	109-00004
Q18L	2.6	195.0	50.0	80	PA66	Black (BK)	100 pcs.	2;4-6	109-00036
	2.6	195.0	50.0	80	PA66	Natural (NA)	100 pcs.	2;4-6	109-00007
Q30R	3.6	160.0	38.0	130	PA66	Black (BK)	100 pcs.	2;4-6	109-00039
	3.6	160.0	38.0	130	PA66	Natural (NA)	100 pcs.	2;4-6	109-00010
Q30L	3.6	200.0	50.0	130	PA66	Black (BK)	100 pcs.	2;4-6	109-00041
	3.6	200.0	50.0	130	PA66	Natural (NA)	100 pcs.	2;4-6	109-00012
Q30LR	3.6	250.0	65.0	130	PA66	Black (BK)	100 pcs.	2;4-6	109-00043
	3.6	250.0	65.0	130	PA66	Natural (NA)	100 pcs.	2;4-6	109-00014
Q50R	4.7	210.0	50.0	220	PA66	Black (BK)	100 pcs.	2-10	109-00047
	4.7	210.0	50.0	220	PA66	Natural (NA)	100 pcs.	2-10	109-00018
Q50I	4.7	290.0	75.0	220	PA66	Black (BK)	100 pcs.	2-10	109-00049
	4.7	290.0	75.0	220	PA66	Natural (NA)	100 pcs.	2-10	109-00020
Q50L	4.7	410.0	110.0	220	PA66	Black (BK)	100 pcs.	2-10	109-00051
	4.7	410.0	110.0	220	PA66	Natural (NA)	100 pcs.	2-10	109-00022
Q120I	7.7	300.0	70.0	530	PA66	Black (BK)	100 pcs.	3;9-12	109-00053
	7.7	300.0	70.0	530	PA66	Natural (NA)	100 pcs.	3;9-12	109-00024
Q120R	7.7	420.0	110.0	530	PA66	Black (BK)	100 pcs.	3;9-12	109-00055
	7.7	420.0	110.0	530	PA66	Natural (NA)	100 pcs.	3;9-12	109-00026
Q120M	7.7	520.0	130.0	530	PA66	Black (BK)	100 pcs.	3;9-12	109-00057
	7.7	520.0	130.0	530	PA66	Natural (NA)	100 pcs.	3;9-12	109-00028
	7.7	520.0	130.0	530	PA66HS	Black (BK)	100 pcs.	3;9-12	109-00115
	7.7	520.0	130.0	530	PA66HS	Natural (NA)	100 pcs.	3;9-12	109-00144

All dimensions in mm. Subject to technical changes.

Minimum Order Quantity (MOQ) may differ from package content. Other packaging options may also be available.

Recommended Tools										
2	3	4	5	6	7	8	9	10	11	12
MK20	MK21	MK3SP	MK3PN5P2	EVO7	MK7HT	MK7P	MK6	MK9	MK9HT	MK9P

For more information on toolings please refer to the Application Tooling chapter.



For product specific approvals and specifications please refer to the Appendix.

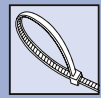

### Cable Ties with open head Polyamide 6.6 standard

#### Q-Series in PA66 coloured

Q-Series cable ties for bundling and securing cables, pipes and hoses. These innovative and effective cable ties enable a simple and quick installation, even in difficult applications.

#### Features and Benefits

- Coloured cable ties available in a wide range of sizes
- Open lock head for quick and easy insertion
- Integrated pre-locking function
- More than 25 % faster to apply than a standard cable tie
- Inside serration for a strong hold around bundles
- Easy application either manually or with a processing tool



Q-ties in different colours are ideal for marking and bundling in one step.



Application video: Q-Series



**Material specification**  
please see page 24.



**Please find more Q-Series products for your system solution on page 134 and 459.**

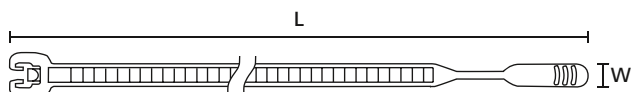

Q-Series

TYPE	Width (W)	Length (L)	Bundle Ø max.	N	Material	Colour	Pack Cont.	Tools	Article-No.
Q18R	2.6	105.0	24.0	80	PA66	Blue (BU)	100 pcs.	2;4-6	109-00147
	2.6	105.0	24.0	80	PA66	Green (GN)	100 pcs.	2;4-6	109-00148
	2.6	105.0	24.0	80	PA66	Red (RD)	100 pcs.	2;4-6	109-00149
	2.6	105.0	24.0	80	PA66	Yellow (YE)	100 pcs.	2;4-6	109-00150
Q18I	2.6	155.0	40.0	80	PA66	Blue (BU)	100 pcs.	2;4-6	109-00152
	2.6	155.0	40.0	80	PA66	Green (GN)	100 pcs.	2;4-6	109-00153
	2.6	155.0	40.0	80	PA66	Red (RD)	100 pcs.	2;4-6	109-00154
	2.6	155.0	40.0	80	PA66	Yellow (YE)	100 pcs.	2;4-6	109-00155
Q18L	2.6	195.0	50.0	80	PA66	Blue (BU)	100 pcs.	2;4-6	109-00157
	2.6	195.0	50.0	80	PA66	Green (GN)	100 pcs.	2;4-6	109-00158
	2.6	195.0	50.0	80	PA66	Red (RD)	100 pcs.	2;4-6	109-00159
	2.6	195.0	50.0	80	PA66	Yellow (YE)	100 pcs.	2;4-6	109-00160

All dimensions in mm. Subject to technical changes.

Minimum Order Quantity (MOQ) may differ from package content. Other packaging options may also be available.

Recommended Tools										
2	3	4	5	6	7	8	9	10	11	12
MK20	MK21	MK3SP	MK3PNSP2	EVO7	MK7HT	MK7P	MK6	MK9	MK9HT	MK9P

For more information on toolings please refer to the Application Tooling chapter.



For product specific approvals and specifications please refer to the Appendix.



## Cable Ties with open head Polyamide 6.6 standard

## Q-Series in PA66 coloured

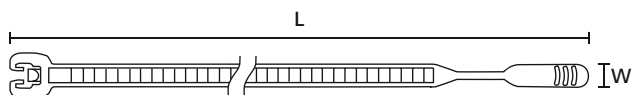

Q-Series

TYPE	Width (W)	Length (L)	Bundle Ø max.	N	Material	Colour	Pack Cont.	Tools	Article-No.
Q30R	3.6	160.0	38.0	130	PA66	Blue (BU)	100 pcs.	2;4-6	109-00162
	3.6	160.0	38.0	130	PA66	Green (GN)	100 pcs.	2;4-6	109-00163
	3.6	160.0	38.0	130	PA66	Red (RD)	100 pcs.	2;4-6	109-00164
	3.6	160.0	38.0	130	PA66	Yellow (YE)	100 pcs.	2;4-6	109-00165
Q30L	3.6	200.0	50.0	130	PA66	Blue (BU)	100 pcs.	2;4-6	109-00167
	3.6	200.0	50.0	130	PA66	Green (GN)	100 pcs.	2;4-6	109-00168
	3.6	200.0	50.0	130	PA66	Red (RD)	100 pcs.	2;4-6	109-00169
	3.6	200.0	50.0	130	PA66	Yellow (YE)	100 pcs.	2;4-6	109-00170
Q30LR	3.6	250.0	65.0	130	PA66	Blue (BU)	100 pcs.	2;4-6	109-00172
	3.6	250.0	65.0	130	PA66	Green (GN)	100 pcs.	2;4-6	109-00173
	3.6	250.0	65.0	130	PA66	Red (RD)	100 pcs.	2;4-6	109-00174
	3.6	250.0	65.0	130	PA66	Yellow (YE)	100 pcs.	2;4-6	109-00175
Q50R	4.7	210.0	50.0	220	PA66	Blue (BU)	100 pcs.	2-10	109-00182
	4.7	210.0	50.0	220	PA66	Green (GN)	100 pcs.	2-10	109-00183
	4.7	210.0	50.0	220	PA66	Red (RD)	100 pcs.	2-10	109-00184
	4.7	210.0	50.0	220	PA66	Yellow (YE)	100 pcs.	2-10	109-00185
Q50I	4.7	290.0	75.0	220	PA66	Blue (BU)	100 pcs.	2-10	109-00187
	4.7	290.0	75.0	220	PA66	Green (GN)	100 pcs.	2-10	109-00188
	4.7	290.0	75.0	220	PA66	Red (RD)	100 pcs.	2-10	109-00189
	4.7	290.0	75.0	220	PA66	Yellow (YE)	100 pcs.	2-10	109-00190
Q50L	4.7	410.0	110.0	220	PA66	Blue (BU)	100 pcs.	2-10	109-00192
	4.7	410.0	110.0	220	PA66	Green (GN)	100 pcs.	2-10	109-00193
	4.7	410.0	110.0	220	PA66	Red (RD)	100 pcs.	2-10	109-00194
	4.7	410.0	110.0	220	PA66	Yellow (YE)	100 pcs.	2-10	109-00195
Q120I	7.7	300.0	70.0	530	PA66	Blue (BU)	100 pcs.	3;9-12	109-00197
	7.7	300.0	70.0	530	PA66	Green (GN)	100 pcs.	3;9-12	109-00198
	7.7	300.0	70.0	530	PA66	Red (RD)	100 pcs.	3;9-12	109-00199
	7.7	300.0	70.0	530	PA66	Yellow (YE)	100 pcs.	3;9-12	109-00200
Q120R	7.7	420.0	110.0	530	PA66	Blue (BU)	100 pcs.	3;9-12	109-00202
	7.7	420.0	110.0	530	PA66	Green (GN)	100 pcs.	3;9-12	109-00203
	7.7	420.0	110.0	530	PA66	Red (RD)	100 pcs.	3;9-12	109-00204
	7.7	420.0	110.0	530	PA66	Yellow (YE)	100 pcs.	3;9-12	109-00205
Q120M	7.7	520.0	130.0	530	PA66	Blue (BU)	100 pcs.	3;9-12	109-00207
	7.7	520.0	130.0	530	PA66	Green (GN)	100 pcs.	3;9-12	109-00208
	7.7	520.0	130.0	530	PA66	Red (RD)	100 pcs.	3;9-12	109-00209
	7.7	520.0	130.0	530	PA66	Yellow (YE)	100 pcs.	3;9-12	109-00210

All dimensions in mm. Subject to technical changes.

Minimum Order Quantity (MOQ) may differ from package content. Other packaging options may also be available.



For product specific approvals and specifications please refer to the Appendix.



### Cable Ties with open head for outdoor use (UV-resistant)

#### Q-Series in PA66W black

Q-Series cable ties for bundling and securing cables, pipes and hoses. These innovative and effective cable ties enable a simple and quick installation, even in difficult applications.

#### Features and Benefits

- Weather-resistant black cable ties available in a wide range of sizes
- Open lock head for quick and easy insertion
- Integrated pre-locking function
- More than 25 % faster to apply than a standard cable tie
- Inside serration for a strong hold around bundles
- Easy application either manually or with a processing tool
- UV-resistant



Q-tie cable ties: choose from a wide product range in different sizes.



**Material specification please see page 24.**



**Please find more Q-Series products for your system solution on page 134 and 459.**

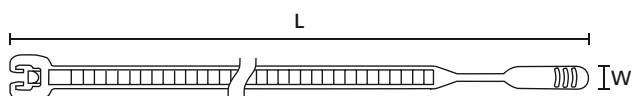

Q-Series

TYPE	Width (W)	Length (L)	Bundle Ø max.	N	Material	Colour	Pack Cont.	Tools	Article-No.
Q18R	2.6	105.0	24.0	80	PA66W	Black (BK)	100 pcs.	2;4-6	109-00059
Q18I	2.6	155.0	40.0	80	PA66W	Black (BK)	100 pcs.	2;4-6	109-00062
Q18L	2.6	195.0	50.0	80	PA66W	Black (BK)	100 pcs.	2;4-6	109-00065
Q30R	3.6	160.0	38.0	130	PA66W	Black (BK)	100 pcs.	2;4-6	109-00068
Q30L	3.6	200.0	50.0	130	PA66W	Black (BK)	100 pcs.	2;4-6	109-00070
Q30LR	3.6	250.0	65.0	130	PA66W	Black (BK)	100 pcs.	2;4-6	109-00072
Q50R	4.7	210.0	50.0	220	PA66W	Black (BK)	100 pcs.	2-10	109-00076
Q50I	4.7	290.0	75.0	220	PA66W	Black (BK)	100 pcs.	2-10	109-00078
Q50L	4.7	410.0	110.0	220	PA66W	Black (BK)	100 pcs.	2-10	109-00080
Q120I	7.7	300.0	70.0	530	PA66W	Black (BK)	100 pcs.	3;9-12	109-00082
Q120R	7.7	420.0	110.0	530	PA66W	Black (BK)	100 pcs.	3;9-12	109-00084
Q120M	7.7	520.0	130.0	530	PA66W	Black (BK)	100 pcs.	3;9-12	109-00086

All dimensions in mm. Subject to technical changes.

Minimum Order Quantity (MOQ) may differ from package content. Other packaging options may also be available.

#### Recommended Tools

2	3	4	5	6	7	8	9	10	11	12
MK20	MK21	MK3SP	MK3PNPSP2	EVO7	MK7HT	MK7P	MK6	MK9	MK9HT	MK9P

For more information on toolings please refer to the Application Tooling chapter.



## Cable Ties with open head for temperatures up to +105 °C (heat stabilised)

### Q-Series in PA66HS natural and black

Q-Series cable ties for bundling and securing cables, pipes and hoses. These innovative and effective cable ties enable a simple and quick installation, even in difficult applications.

#### Features and Benefits

- Heat stabilised cable ties available in a wide range of sizes
- Open lock head for quick and easy insertion
- Integrated pre-locking function
- More than 25 % faster to apply than a standard cable tie
- Inside serration for a strong hold around bundles
- Easy application either manually or with a processing tool
- Higher temperature resistance up to +105 °C



Q-tie cable ties: choose from a wide product range in different sizes.

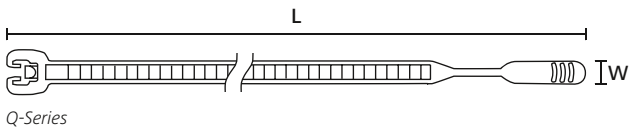

Q-Series



Material specification please see page 24.

TYPE	Width (W)	Length (L)	Bundle Ø max.		Material	Colour	Pack Cont.	Tools	Article-No.
Q18R	2.6	105.0	24.0	80	PA66HS	Black (BK)	100 pcs.	2;4-6	109-00088
	2.6	105.0	24.0	80	PA66HS	Natural (NA)	100 pcs.	2;4-6	109-00117
Q18I	2.6	155.0	40.0	80	PA66HS	Black (BK)	100 pcs.	2;4-6	109-00091
	2.6	155.0	40.0	80	PA66HS	Natural (NA)	100 pcs.	2;4-6	109-00120
Q18L	2.6	195.0	50.0	80	PA66HS	Black (BK)	100 pcs.	2;4-6	109-00094
	2.6	195.0	50.0	80	PA66HS	Natural (NA)	100 pcs.	2;4-6	109-00123
Q30R	3.6	160.0	38.0	130	PA66HS	Black (BK)	100 pcs.	2;4-6	109-00097
	3.6	160.0	38.0	130	PA66HS	Natural (NA)	100 pcs.	2;4-6	109-00126
Q30L	3.6	200.0	50.0	130	PA66HS	Black (BK)	100 pcs.	2;4-6	109-00099
	3.6	200.0	50.0	130	PA66HS	Natural (NA)	100 pcs.	2;4-6	109-00128
Q30LR	3.6	250.0	65.0	130	PA66HS	Black (BK)	100 pcs.	2;4-6	109-00101
	3.6	250.0	65.0	130	PA66HS	Natural (NA)	100 pcs.	2;4-6	109-00130
Q50R	4.7	210.0	50.0	220	PA66HS	Black (BK)	100 pcs.	2-10	109-00105
	4.7	210.0	50.0	220	PA66HS	Natural (NA)	100 pcs.	2-10	109-00134
Q50I	4.7	290.0	75.0	220	PA66HS	Black (BK)	100 pcs.	2-10	109-00107
	4.7	290.0	75.0	220	PA66HS	Natural (NA)	100 pcs.	2-10	109-00136
Q50L	4.7	410.0	110.0	220	PA66HS	Black (BK)	100 pcs.	2-10	109-00109
	4.7	410.0	110.0	220	PA66HS	Natural (NA)	100 pcs.	2-10	109-00138
Q120I	7.7	300.0	70.0	530	PA66HS	Black (BK)	100 pcs.	3;9-12	109-00111
	7.7	300.0	70.0	530	PA66HS	Natural (NA)	100 pcs.	3;9-12	109-00140
Q120R	7.7	420.0	110.0	530	PA66HS	Black (BK)	100 pcs.	3;9-12	109-00113
	7.7	420.0	110.0	530	PA66HS	Natural (NA)	100 pcs.	3;9-12	109-00142
Q120M	7.7	520.0	130.0	530	PA66HS	Black (BK)	100 pcs.	3;9-12	109-00115
	7.7	520.0	130.0	530	PA66HS	Natural (NA)	100 pcs.	3;9-12	109-00144

All dimensions in mm. Subject to technical changes.

Minimum Order Quantity (MOQ) may differ from package content. Other packaging options may also be available.

Recommended Tools										
2	3	4	5	6	7	8	9	10	11	12
MK20	MK21	MK3SP	MK3PNSP2	EVO7	MK7HT	MK7P	MK6	MK9	MK9HT	MK9P

For more information on toolings please refer to the Application Tooling chapter.

## Material Specification Overview

MATERIAL	Material Shortcut	Operating Temperature	Colour**	Flammability	Material Properties*	Material Specifications
Aluminium-alloy	AL	-40 °C to +180 °C	Natural (NA)		<ul style="list-style-type: none"> <li>Corrosion resistant</li> <li>Antimagnetic</li> </ul>	RoHS
Chloroprene	CR	-20 °C to +80 °C	Black (BK)		<ul style="list-style-type: none"> <li>Weather-resistant</li> <li>High yield strength</li> </ul>	RoHS
Ethylene Tetrafluoroethylene	E/TFE	-80 °C to +170 °C	Blue (BU)	UL94 V0	<ul style="list-style-type: none"> <li>Resistance to radioactivity</li> <li>UV-resistant, not moisture sensitive</li> <li>Good chemical resistance to: acids, bases, oxidizing agents</li> </ul>	RoHS
Polyacetal	POM	-40 °C to +90 °C, (+110 °C, 500 h)	Natural (NA)	UL94 HB	<ul style="list-style-type: none"> <li>Limited brittleness sensitivity</li> <li>Flexible at low temperature</li> <li>Not moisture sensitive</li> <li>Robust on impacts</li> </ul>	RoHS
Polyamide 11	PA11	-40 °C to +85 °C, (+105 °C, 500 h)	Black (BK)	UL94 HB	<ul style="list-style-type: none"> <li>Bio-plastic, derived from vegetable oil</li> <li>Strong impact resistance at low temperature</li> <li>Very low moisture absorption</li> <li>Weather-resistant</li> <li>Good chemical resistance</li> </ul>	HF RoHS
Polyamide 12	PA12	-40 °C to +85 °C, (+105 °C, 500 h)	Black (BK)	UL94 HB	<ul style="list-style-type: none"> <li>Good chemical resistance to: acids, bases, oxidizing agents</li> <li>UV-resistant</li> </ul>	HF RoHS
Polyamide 4.6	PA46	-40 °C to +150 °C (5000 h), +195 °C (500 h)	Natural (NA), Grey (GY)	UL94 V2	<ul style="list-style-type: none"> <li>Resistance to high temperatures</li> <li>Very moisture sensitive</li> <li>Low smoke sensitive</li> </ul>	HF LFH RoHS
Polyamide 6	PA6	-40 °C to +80 °C	Black (BK)	UL94 V2	<ul style="list-style-type: none"> <li>High yield strength</li> </ul>	RoHS
Polyamide 6, high impact modified	PA6HIR	-40 °C to +80 °C	Black (BK)	UL94 HB	<ul style="list-style-type: none"> <li>Limited brittleness sensitivity</li> <li>Higher flexibility at low temperature</li> </ul>	RoHS
Polyamide 6.6	PA66	-40 °C to +85 °C, (+105 °C, 500 h)	Black (BK), Natural (NA)	UL94 V2	<ul style="list-style-type: none"> <li>High yield strength</li> </ul>	HF RoHS
Polyamide 6.6, glass-fibre reinforced	PA66GF13, PA66GF15	-40 °C to +105 °C	Black (BK)	UL94 HB	<ul style="list-style-type: none"> <li>Good resistance to: lubricants, vehicle fuel, salt water and many solvents</li> </ul>	HF RoHS
Polyamide 6.6, heat and UV stabilised	PA66HSW	-40 °C to +105 °C	Black (BK)	UL94 V2	<ul style="list-style-type: none"> <li>High yield strength</li> <li>Modified elevated max. temperature</li> <li>UV-resistant</li> </ul>	HF RoHS
Polyamide 6.6, heat stabilised	PA66HS	-40 °C to +105 °C	Black (BK), Natural (NA)	UL94 V2	<ul style="list-style-type: none"> <li>High yield strength</li> <li>Modified elevated max. temperature</li> </ul>	HF RoHS
Polyamide 6.6, high impact modified	PA66HIR	-40 °C to +80 °C, (+105 °C, 500 h)	Black (BK)	UL94 HB	<ul style="list-style-type: none"> <li>Limited brittleness sensitivity</li> <li>Higher flexibility at low temperature</li> </ul>	RoHS
Polyamide 6.6, high impact modified, heat and UV stabilised	PA66HIRHSW	-40 °C to +110 °C	Black (BK)	UL94 HB	<ul style="list-style-type: none"> <li>Limited brittleness sensitivity</li> <li>Higher flexibility at low temperature</li> <li>Modified elevated max. temperature</li> <li>High yield strength, UV-resistant</li> </ul>	HF RoHS
Polyamide 6.6, high impact modified, heat stabilised	PA66HIRHS	-40 °C to +105 °C	Black (BK)	UL94 HB	<ul style="list-style-type: none"> <li>Limited brittleness sensitivity</li> <li>Higher flexibility at low temperature</li> <li>Modified elevated max. temperature</li> </ul>	RoHS
Polyamide 6.6, high impact modified, scan black	PA66HIR(S)	-40 °C to +80 °C, (+105 °C, 500 h)	Black (BK)	UL94 HB	<ul style="list-style-type: none"> <li>Limited brittleness sensitivity</li> <li>Higher flexibility at low temperature</li> </ul>	HF RoHS
Polyamide 6.6, UV-resistant	PA66W	-40 °C to +85 °C, (+105 °C, 500 h)	Black (BK)	UL94 V2	<ul style="list-style-type: none"> <li>High yield strength</li> <li>UV-resistant</li> </ul>	HF RoHS

Tefzel® is a registered trademark of DuPont. General linguistic usage for cable ties made from raw material E/TFE is Tefzel®-Tie. \*\*More colours on request.

In addition to Tefzel® from DuPont HellermannTyton is also using equivalent E/TFE raw material from other suppliers.

\*These details are only rough guide values. They should not be regarded as a material specification and are no substitute for a suitability test. Please see our datasheets for further details.

 = Minimum Loop Tensile Strength for Cable Ties (Newton)

HF = Halogenfree  
LFH = Limited Fire Hazard  
RoHS = Restriction of Hazardous Substances



MATERIAL	Material Shortcut	Operating Temperature	Colour**	Flammability	Material Properties*	Material Specifications
<b>Polyamide 6.6</b> , with metal particles	PA66MP	-40 °C to +85 °C, (+105 °C, 500 h)	Blue (BU)	UL94 HB	<ul style="list-style-type: none"> <li>High yield strength</li> <li>Metal and X-Ray detectable</li> </ul>	<b>HF</b> <b>RoHS</b>
<b>Polyamide 6.6 V0</b>	PA66V0	-40 °C to +85 °C	White (WH)	UL94 V0	<ul style="list-style-type: none"> <li>High yield strength</li> <li>Low smoke emission</li> </ul>	<b>HF</b> <b>LFH</b> <b>RoHS</b>
<b>Polyamide 6.6 V0</b> , High Oxygen Index	PA66V0-HOI	-40 °C to +85 °C, (+105 °C, 500 h)	White (WH)	UL94 V0	<ul style="list-style-type: none"> <li>High yield strength</li> <li>Low smoke emissions</li> </ul>	<b>HF</b> <b>LFH</b> <b>RoHS</b>
<b>Polyester</b>	SP	-50 °C to +150 °C	Black (BK)	Halogen free	<ul style="list-style-type: none"> <li>UV-resistant</li> <li>Good chemical resistance to: most acids, alkalis and oils</li> </ul>	<b>HF</b> <b>LFH</b> <b>RoHS</b>
<b>Polyetheretherketone</b>	PEEK	-55 °C to +240 °C	Beige (BGE)	UL94 V0	<ul style="list-style-type: none"> <li>Resistance to radioactivity</li> <li>Not moisture sensitive</li> <li>Good chemical resistance to: acids, bases, oxidizing agents</li> </ul>	<b>HF</b> <b>LFH</b> <b>RoHS</b>
<b>Polyethylene</b>	PE	-40 °C to +50 °C	Black (BK), Grey (GY)	UL94 HB	<ul style="list-style-type: none"> <li>Low moisture absorption</li> <li>Good chemical resistance to: most acids, alcohol and oils</li> </ul>	<b>HF</b> <b>RoHS</b>
<b>Polyolefin</b>	PO	-40 °C to +90 °C	Black (BK)	UL94 V0	<ul style="list-style-type: none"> <li>Low smoke emissions</li> </ul>	<b>HF</b> <b>LFH</b> <b>RoHS</b>
<b>Polypropylene</b>	PP	-40 °C to +115 °C	Black (BK), Natural (NA)	UL94 HB	<ul style="list-style-type: none"> <li>Floats in water</li> <li>Moderate yield strength</li> <li>Good chemical resistance to: organic acids</li> </ul>	<b>HF</b> <b>RoHS</b>
<b>Polypropylene, Ethylene- Propylene-Dien- Terpolymere-rubber</b> free of Nitrosamine	PP, EPDM	-20 °C to +95 °C	Black (BK)	UL94 HB	<ul style="list-style-type: none"> <li>Good resistance to high temperatures</li> <li>Good chemical and abrasion resistance</li> </ul>	<b>HF</b> <b>RoHS</b>
<b>Polypropylene</b> with metal particles	PPMP	-40 °C to +115 °C	Blue (BU)	UL94 HB	<ul style="list-style-type: none"> <li>Floats in certain liquids</li> <li>Metal and X-Ray detectable</li> <li>Heat resistant</li> <li>Moderate yield strength</li> <li>Good chemical resistance</li> </ul>	<b>RoHS</b>
<b>Polyvinylchloride</b>	PVC	-10 °C to +70 °C	Black (BK), Natural (NA)	UL94 V0	<ul style="list-style-type: none"> <li>Low moisture absorption</li> <li>Good chemical resistance to: acids, ethanol and oil</li> </ul>	<b>RoHS</b>
<b>Stainless Steel, Stainless Steel</b>	SS304, SS316	-80 °C to +538 °C	Natural (NA)	Non burning	<ul style="list-style-type: none"> <li>Corrosion resistant</li> <li>Antimagnetic</li> <li>Weather resistant</li> <li>Outstanding chemical resistance</li> </ul>	<b>HF</b> <b>LFH</b> <b>RoHS</b>
<b>Thermoplastic Polyurethane</b>	TPU	-40 °C to +85 °C	Black (BK)	UL94 HB	<ul style="list-style-type: none"> <li>High elasticity</li> <li>Good chemical resistance to: acids, bases and oxidizing agents</li> </ul>	<b>HF</b> <b>RoHS</b>

Tefzel® is a registered trademark of DuPont. General linguistic usage for cable ties made from raw material E/TFE is Tefzel®-Tie. In addition to Tefzel® from DuPont HellermannTyton is also using equivalent E/TFE raw material from other suppliers.

\*These details are only rough guide values. They should not be regarded as a material specification and are no substitute for a suitability test. Please see our datasheets for further details.

\*\*More colours on request.



**N** = Minimum Loop Tensile Strength  
for Cable Ties (Newton)

**HF** = Halogenfree  
**LFH** = Limited Fire Hazard  
**RoHS** = Restriction of Hazardous Substances

## X-ON Electronics

Largest Supplier of Electrical and Electronic Components

*Click to view similar products for [Cable Ties](#) category:*

*Click to view products by [Hellermann](#) manufacturer:*

Other Similar products are found below :

[20093-0](#) [SJ-3463](#) [SJ3518FR-1x50](#) [SJ3526N-Beige-2"x50yd](#) [SJ3526N BLACK 58" X 50YD](#) [SJ3571](#) [SJ-3571-1"x50yd-Black](#) [20113-0](#)  
[T56137](#) [3-350087-0](#) [CTB75X75BKA-C](#) [3722](#) [561-B110120](#) [561-EZAB580T](#) [561-EZS375B40](#) [561-N3510](#) [561-TA250125](#) [08350-0](#) [08443-0](#)  
[08600-0](#) [10035-0](#) [10036-0](#) [10037-0](#) [10325-0](#) [10362-0](#) [10606-0](#) [561-EZ250](#) [561-EZ500](#) [561-EZ625](#) [561-EZ750](#) [561-TA00600](#) [SJ3519FR](#)  
[BLACK 1X50](#) [SJ3527N-Beige-2"x50yd](#) [SJ3527N-LOOP-BLACK-1](#) [SJ3572-2"x50yd-Black](#) [157-00039](#) [3719](#) [SJ-3401 BLACK 1"](#) [08445-0](#)  
[08582-0](#) [08386-0](#) [10431-0](#) [08359-0](#) [10056-0](#) [10620-0](#) [10345-0](#) [10344-0](#) [08416-0](#) [08384-0](#) [08401-0](#)