

R13-273  H-0 2

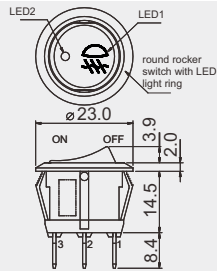

0 2  .187" SQ

20A 14V DC
10A 28V DC

FEATURES

- * MATERIAL: Frame & actuator is PC.
- * LED light ring always illuminated.
- * The graphic is laser marking.

Cut-out

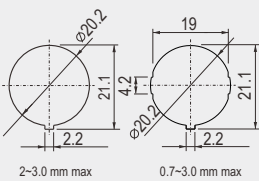

2~3.0 mm max
0.7~3.0 mm max

FUNCTION

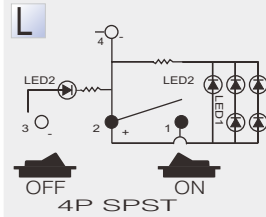
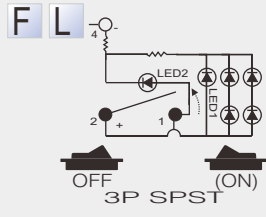
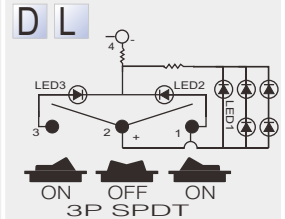
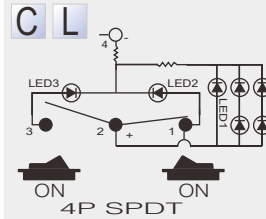
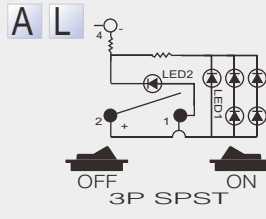

SWITCH FOR MASSAGE CHAIR

R13-928

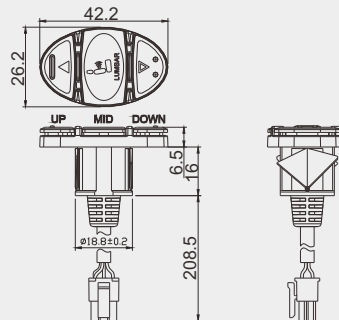

Rating
50mA 12V DC
Insulation resistance
DC 100V 100MΩ Min
Dielectric strength
AC 250V 1 minute

Cut out

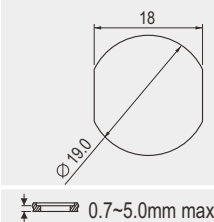

0.7~5.0mm max

FEATURES

- * MATERIAL: Frame is PC. Actuator are PC.
- * 3 positions (up/mid/down) adjusted by actuators.
- * Graphic and customer logo in laser marking.
- * Visible symbols with backlight blue LED.
- * Switch function: 3 Sws (push on)+ 3 Blue LEDs (independent) always light on.

CIRCUIT DIAGRAM

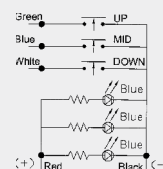

X-ON Electronics

Largest Supplier of Electrical and Electronic Components

Click to view similar products for [Rocker Switches](#) category:

Click to view products by [SCI](#) manufacturer:

Other Similar products are found below :

[VKD2GHNB-00000-000](#) [VSD2GNNB-00000-000](#) [7036WWCDBX653+U622](#) [7747NAB+U627/1](#) [8055K52Z7V](#) [8138K20E6M50](#) [FMC18A2200002](#)
[84206L](#) [84312LX](#) [PREDD4-07F-BB0FW](#) [PREDD5-07F-BB0GW](#) [PRFDD1-16F-BB000](#) [999-16702-001](#) [A101J2ZQ004](#) [A101J4ZQ004](#)
[A101J51CB0004](#) [A107J51ZQ0004](#) [A201J1AQ004](#) [A201J1AV2Q004](#) [A201J3ZB004](#) [A201J50ZQ004](#) [A203J51ZQ0004](#) [A226L11YZQ](#) [A22L11A](#)
[A435S1YZQ](#) [H8500XBBBBL-A](#) [HB130CHNWWNAAC](#) [1251.0303](#) [AE205J60V3B004](#) [RH110C2NBB](#) [1352.0107](#) [1363.0201](#) [AML23GBE2AA05](#)
[AML25GBF2AA03GR](#) [1571099-3](#) [1571987-4](#) [B123J77V7B2](#) [B226J50W4Q22P](#) [B433J37ZQ22M](#) [160212E](#) [1801.1164](#) [1831.1102](#) [1833.3402](#)
[1837.1118](#) [1838.8302](#) [1839.1502](#) [K1ABBSCADN](#) [K2ABAAAAAA](#) [RSCA211-VB-B-9-V](#) [2600R21E](#)