

# Enclosures

## Compact enclosures

### Compact enclosures AE

Spray-finished

AE 1032.500 (1035.500)

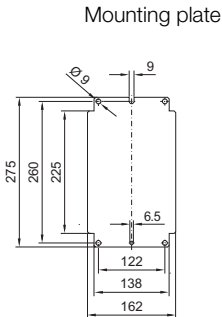
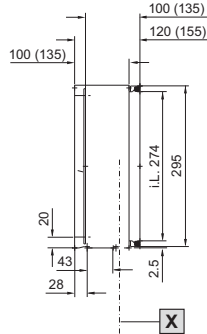
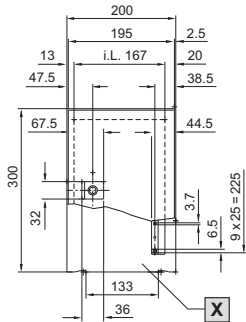

i.L. = Clearance width

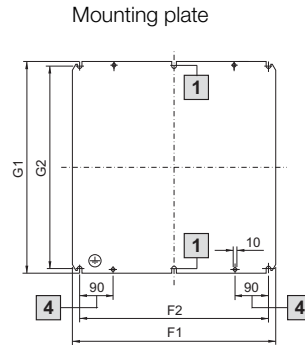
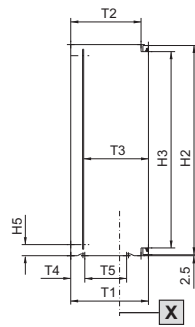
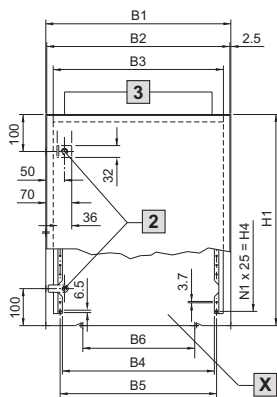

Dimensions for wall-mounting

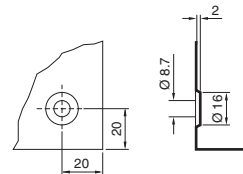

X Door interior view

1 Only for AE 1180.500

2 From 500 mm high with 2 cam locks, less than 500 mm with 1 cam lock in the centre

3 AE 1073.500 and AE 1180.500 with holes for eyebolts, view Y, see page 2 below.

4 (50) for AE 1033.500, AE 1034.500 and AE 1036.500

Model No. AE	Width dimensions mm						Height dimensions mm					Depth dimensions mm					Mounting plates mm				
	B1	B2	B3	B4	B5	B6	H1	H2	H3	H4	H5	N1	T1	T2	T3	T4	T5	F1	F2	G1	G2
1036.500	300	295	260	211	223	233	300	295	260	225	27.5	9	155	132	113 – 129	47	45	254	215	275	250
1033.500	300	295	260	211	223	233	300	295	260	225	27.5	9	210	190	168 – 184	43	45	254	215	275	250
1034.500	300	295	260	211	223	233	400	395	360	325	27.5	13	210	190	168 – 184	43	45	254	215	375	350
1030.500	380	375	340	291	303	303	300	295	260	225	27.5	9	155	132	113 – 129	33	63	334	295	275	250
1031.500	380	375	340	291	303	303	300	295	260	225	27.5	9	210	190	168 – 184	33	63	334	295	275	250
1380.500	380	375	340	291	303	303	380	375	340	275	27.5	11	210	190	168 – 184	33	63	334	295	355	330
1039.500	600	595	560	511	523	500	380	375	340	275	27.5	11	210	190	168 – 184	38	113	549	510	355	330
1339.500	600	595	560	511	523	500	380	375	340	275	27.5	11	350	330	308 – 324	38	113	549	510	355	330
1038.500	380	375	340	291	303	303	600	595	560	525	30	21	210	190	168 – 184	33	63	334	295	570	545
1338.500	380	375	340	291	303	303	600	595	560	525	30	21	350	330	308 – 324	84	113	334	295	570	545
1045.500	400	395	360	311	323	303	500	495	460	425	30	17	210	190	168 – 184	38	113	354	315	475	450
1037.500	400	395	360	311	323	303	800	795	760	725	30	29	300	280	258 – 274	38	113	349	310	770	745
1050.500	500	495	460	411	423	303	500	495	460	425	30	17	210	190	168 – 184	38	113	449	410	470	445
1350.500	500	495	460	411	423	303	500	495	460	425	30	17	300	280	258 – 274	38	113	449	410	470	445
1057.500	500	495	460	411	423	303	700	695	660	625	30	25	250	230	208 – 224	38	113	449	410	670	645
1060.500	600	595	560	511	523	500	600	595	560	525	30	21	210	190	168 – 184	38	113	549	510	570	545
1054.500	600	595	560	511	523	500	600	595	560	525	30	21	250	230	208 – 224	38	113	549	510	570	545
1360.500	600	595	560	511	523	500	600	595	560	525	30	21	350	330	308 – 324	38	113	549	510	570	545
1076.500	600	595	560	511	523	500	760	755	720	675	30	27	210	190	168 – 184	38	113	549	510	730	705
1376.500	600	595	560	511	523	500	760	755	720	675	30	27	350	330	308 – 324	38	113	549	510	730	705
1058.500	600	595	560	511	523	500	800	795	760	725	30	29	250	230	208 – 224	38	113	549	510	770	745
1090.500	600	595	560	511	523	500	1000	995	960	925	35	37	250	230	208 – 224	38	113	539	500	955	930
1077.500	760	755	720	671	683	500	760	755	720	675	30	27	210	190	168 – 184	38	113	704	665	730	705
1073.500	760	755	720	671	683	500	760	755	720	675	30	27	300	280	258 – 274	38	113	704	665	730	705
1055.500	800	795	760	711	723	500	600	595	560	525	30	21	300	280	258 – 274	38	113	749	710	570	545
1180.500	800	795	760	711	723	500	1000	995	960	925	35	37	300	280	258 – 274	70	113	739	700	955	930

### Compact enclosures AE

Spray-finished

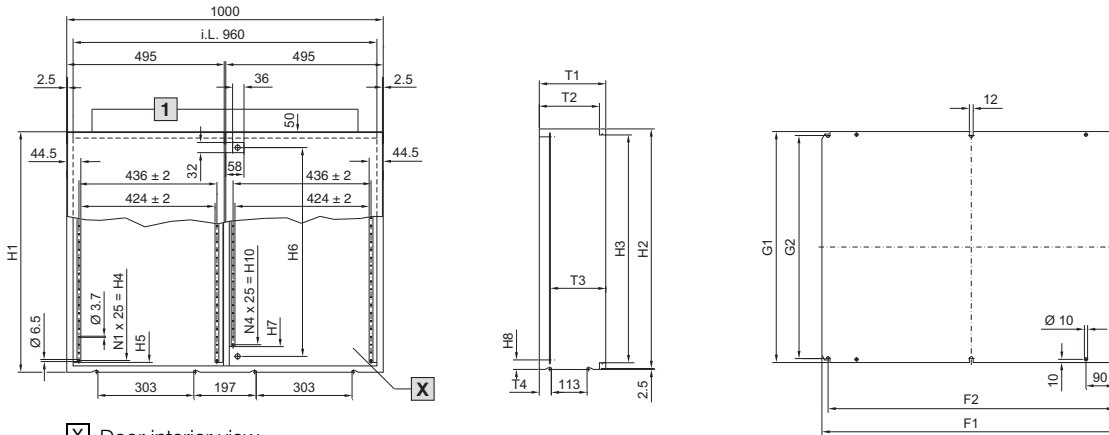

X Door interior view

1 AE 1110.500 and AE 1130.500 with holes for eyebolts, view Y, see page 2 below.

i.L. = Clearance width

Detail wall-mounting holes, see page 1 at the top.

Model No. AE	H1	H2	H3	H4	H5	H6	H7	H8	H10	N1	N4	T1	T2	T3	T4	F1	F2	G1	G2
Spray-finished																			
1100.500	760	755	720	675	698	660	598	30	575	27	23	210	190	168 - 184	38	944	905	730	705
1130.500	760	755	720	675	698	660	598	30	575	27	23	300	280	258 - 274	70	944	905	730	705
1110.500	1000	995	960	925	938	900	838	35	825	37	33	300	280	258 - 274	70	939	900	955	930

### Spray-finished

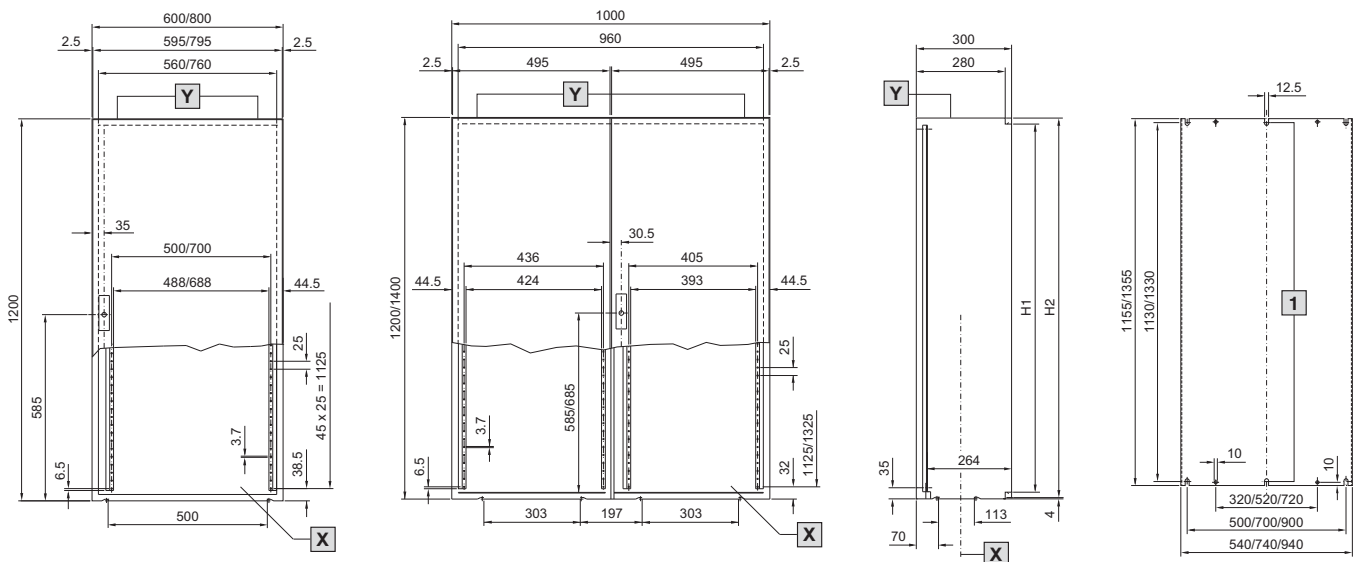

View Y

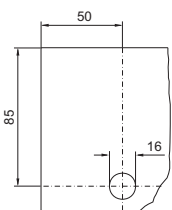

X Door interior view

Y Hole for eyebolts

i.L. = Clearance width

Detail of wall-mounting holes, see page 1 at the top.

1 Do not apply to AE 1260.500

Model No. AE	W mm	H mm	i.L. H1 mm	H2 mm	D mm	Door(s)
Spray-finished						
1260.500	600	1200	1160	1194	300	1
1280.500	800	1200	1160	1194	300	1
1213.500	1000	1200	1160	1194	300	2
1114.500	1000	1400	1360	1394	300	2

## X-ON Electronics

Largest Supplier of Electrical and Electronic Components

*Click to view similar products for [Mounting Fixings](#) category:*

*Click to view products by [Rittal](#) manufacturer:*

Other Similar products are found below :

[5912235-2](#) [007310](#) [007541](#) [6-141-P](#) [620HA038NF09](#) [620HA038NF11](#) [CTJ420E028-513](#) [M81714/60-12-01](#) [M81714/60-22-01](#) [L/C](#)  
[MA1EAF1200](#) [70-584649-01P](#) [71-074914-006](#) [71-215091-8S](#) [712HA170B23128-N](#) [71-344699-4S](#) [71-441549-19S](#) [71-441864-5S](#) [71-](#)  
[490451-4H](#) [EX-13-3-B-16-325PN](#) [75-69116-8S](#) [75-69211-3P](#) [75-69220-27S](#) [75-69224-5S](#) [75-69614-2S](#) [770-006A109](#) [770-006A109R](#) [770-](#)  
[006A207](#) [770-006A208W1](#) [770-006A209](#) [770-006A306](#) [770-006A703W1](#) [770-006A704](#) [770-006A704W1](#) [770-006A705](#) [770-006A706](#)  
[770-006A706W1](#) [770-006A707](#) [770-006A709](#) [770-007A203](#) [770-007A203W1](#) [770-007A204W1](#) [770-007A207W1](#) [770-007A703](#) [770-](#)  
[007A704W1](#) [770-007A706](#) [770-007A707W1](#) [770-010Y208](#) [770-010Y308](#) [770-010Y705](#) [770-010Y706](#)