



# SARA-G450

## Quad-band GSM/GPRS modules

### Data Sheet



#### Abstract

Technical data sheet describing the SARA-G450 GSM/GPRS cellular modules. These modules are complete and cost efficient solutions offering quad-band GSM/GPRS data transmission technology in a compact form factor.

# Document Information

<b>Title</b>	<b>SARA-G450</b>	
<b>Subtitle</b>	Quad-band GSM/GPRS modules	
<b>Document type</b>	Data Sheet	
<b>Document number</b>	UBX-18006165	
<b>Revision and date</b>	R05	30-Nov-2018
<b>Disclosure Restriction</b>		

<b>Product status</b>	<b>Corresponding content status</b>	
<b>Functional Sample</b>	Draft	For functional testing. Revised and supplementary data will be published later.
<b>In Development / Prototype</b>	Objective Specification	Target values. Revised and supplementary data will be published later.
<b>Engineering Sample</b>	Advance Information	Data based on early testing. Revised and supplementary data will be published later.
<b>Initial Production</b>	Early Production Information	Data from product verification. Revised and supplementary data may be published later.
<b>Mass Production / End of Life</b>	Production Information	Document contains the final product specification.

This document applies to the following products:

<b>Product name</b>	<b>Type number</b>	<b>Modem version</b>	<b>Application version</b>	<b>PCN reference</b>	<b>Product status</b>
SARA-G450	SARA-G450-00C-00	09.02	A02.01	UBX-18067098	Initial Production

u-blox or third parties may hold intellectual property rights in the products, names, logos and designs included in this document. Copying, reproduction, modification or disclosure to third parties of this document or any part thereof is only permitted with the express written permission of u-blox.

The information contained herein is provided "as is" and u-blox assumes no liability for its use. No warranty, either express or implied, is given, including but not limited to, with respect to the accuracy, correctness, reliability and fitness for a particular purpose of the information. This document may be revised by u-blox at any time without notice. For the most recent documents, visit [www.u-blox.com](http://www.u-blox.com).

Copyright © u-blox AG.

# Contents

<b>Document Information</b> .....	<b>2</b>
<b>Contents</b> .....	<b>3</b>
<b>1 Functional description</b> .....	<b>5</b>
1.1 Overview.....	5
1.2 Product features .....	5
1.3 Block diagram .....	6
1.4 Product description .....	6
1.5 AT command support .....	7
1.6 Supported features .....	7
<b>2 Interfaces</b> .....	<b>9</b>
2.1 Power management .....	9
2.1.1 Module supply input (VCC) .....	9
2.1.2 RTC supply input/output (V_BCKP) .....	9
2.1.3 Digital I/O interfaces supply output (V_INT) .....	9
2.2 Antenna.....	9
2.2.1 Antenna RF interface (ANT) .....	9
2.2.2 Antenna detection (ANT_DET) .....	9
2.3 System functions.....	10
2.3.1 Module power-on (PWR_ON) .....	10
2.3.2 Module power-off.....	10
2.3.3 Module reset .....	10
2.3.4 Digital I/O interfaces voltage selection (VSEL).....	10
2.4 SIM .....	11
2.4.1 (U)SIM interface.....	11
2.4.2 SIM card detection (SIM_DET).....	11
2.5 Serial interfaces .....	11
2.5.1 Asynchronous serial interface (UART) .....	11
2.5.2 Secondary auxiliary asynchronous serial interface (AUX UART) .....	12
2.5.3 Additional asynchronous serial interface for FW upgrade and Tracing (FT UART) .....	12
2.5.4 DDC (I <sup>2</sup> C compatible) interface .....	13
2.6 Audio interfaces .....	13
2.7 GPIO .....	13
<b>3 Pin definition</b> .....	<b>14</b>
3.1 Pin assignment.....	14
<b>4 Electrical specifications</b> .....	<b>18</b>
4.1 Absolute maximum rating.....	18
4.1.1 Maximum ESD.....	18
4.2 Operating conditions.....	19
4.2.1 Operating temperature range.....	19
4.2.2 Supply/Power pins .....	19

4.2.3	Current consumption.....	20
4.2.4	RF performance .....	20
4.2.5	ANT_DET pin.....	21
4.2.6	PWR_ON pin.....	21
4.2.7	PWR_OFF pin.....	21
4.2.8	SIM pins .....	21
4.2.9	Generic Digital Interfaces pins .....	22
4.2.10	DDC (I <sup>2</sup> C) pins.....	22
<b>5</b>	<b>Mechanical specifications .....</b>	<b>23</b>
<b>6</b>	<b>Qualification and approvals.....</b>	<b>25</b>
6.1	Reliability tests .....	25
6.2	Approvals .....	25
<b>7</b>	<b>Product handling.....</b>	<b>26</b>
7.1	Packaging .....	26
7.1.1	Reels .....	26
7.1.2	Tapes.....	27
7.2	Moisture sensitivity levels.....	28
7.3	Reflow soldering .....	28
7.4	ESD precautions.....	28
<b>8</b>	<b>Default settings .....</b>	<b>29</b>
<b>9</b>	<b>Labeling and ordering information .....</b>	<b>30</b>
9.1	Product labeling.....	30
9.2	Explanation of codes .....	30
9.3	Ordering information.....	31
<b>Appendix</b>	<b>.....</b>	<b>32</b>
<b>A</b>	<b>Glossary .....</b>	<b>32</b>
<b>Related documents</b>	<b>.....</b>	<b>34</b>
<b>Revision history</b>	<b>.....</b>	<b>34</b>
<b>Contact.....</b>	<b>.....</b>	<b>35</b>

# 1 Functional description

## 1.1 Overview

SARA-G450 modules are versatile 2.5G GSM/GPRS cellular modules in the miniature SARA 96-pin LGA (Land Grid Array) form factor (26.0 x 16.0 mm).

Featuring low power consumption, the SARA-G450 modules combine baseband, RF transceiver, power management unit, and power amplifier in a single solution allowing an easy integration into compact designs and a seamless drop-in migration from other u-blox cellular module families supporting 2G, 3G, LTE and LPWA (Cat M1 and Cat NB1) radio access technologies.

SARA-G450 modules provide a fully qualified and certified solution, reducing cost and enabling short time to market. These modules are ideally suited for M2M applications such as: Automatic Meter Reading (AMR), Remote Monitoring Automation and Control (RMAC), surveillance and security, road pricing, asset tracking, fleet management, anti-theft systems and Point of Sales (PoS) terminals.

SARA-G450 modules are full-feature GSM/GPRS quad band cellular modules with a comprehensive feature set including an extensive set of internet protocols. The modules are also designed to provide fully integrated access to u-blox GNSS positioning chips and modules, with embedded A-GPS (AssistNow Online and AssistNow Offline) functionality. Any host processor connected to the cellular module through a single serial port can control both the cellular module and the positioning chip/module.

The SARA-G450 modules' compact form factor and LGA pads allow fully automated assembly with standard pick & place and reflow soldering equipment for cost-efficient, high-volume production.

## 1.2 Product features

Model	Data rate	Bands	Interfaces	Audio	Features	Grade
	GPRS multi-slot class 12	GSM/GPRS 4-band	UART SPI USB 2.0 DDC (I <sup>2</sup> C) GPIO	Analog audio Digital audio	Network indication Antenna supervisor Jamming detection Embedded TCP/UDP Embedded HTTP, FTP Embedded SSL / TLS GNSS via modem AssistNow Software CellLocate® FW update via serial FOTA Dual stack IPv4 / IPv6	Standard Professional Automotive
<b>SARA-G450</b>	●	●	● ○ ●	○ ○	● ● ○ ● ● ● ○ ○ ○ ● ● ●	●

● = supported by all FW versions

○ = supported by future FW versions

Table 1: SARA-G450 modules' main features summary

### 1.3 Block diagram

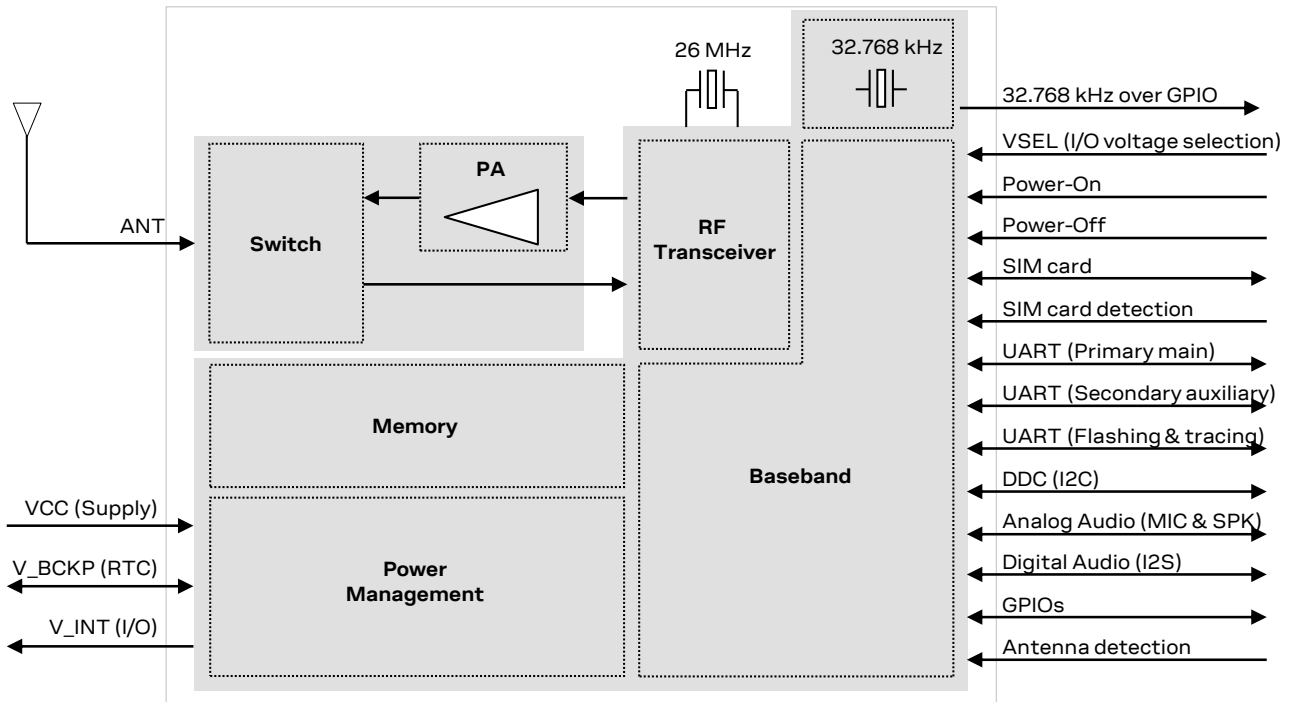

Figure 1: SARA-G450 modules' block diagram

SARA-G450-00C modules, i.e. the “00” product version of the SARA-G450 modules, do not support the following interfaces, which should be left unconnected and should not be driven by external devices:

- Secondary auxiliary UART interface
- DDC (I<sup>2</sup>C) interface
- Analog audio interface
- Digital audio interface

### 1.4 Product description

Item	SARA-G450
GSM/GPRS Protocol Stack	3GPP Release 99
GSM/GPRS bands	GSM 850 MHz E-GSM 900 MHz DCS 1800 MHz PCS 1900 MHz
GSM/GPRS Power Class	Class 4 (33 dBm) for 850/900 bands Class 1 (30 dBm) for 1800/1900 bands
Packet Switched Data Rate	GPRS multi-slot class 12 <sup>1</sup> Coding scheme CS1-CS4 Up to 85.6 kb/s DL <sup>2</sup> Up to 85.6 kb/s UL <sup>2</sup>

Table 2: SARA-G450 modules' GSM/GPRS characteristics summary

<sup>1</sup> GPRS multi-slot class 12 implies a maximum of 4 slots in Down-Link (reception) and 4 slots in Up-Link (transmission) with 5 slots in total. The SARA-G450 modules can be configured as GPRS multi-slot class 10 by means of AT command.

<sup>2</sup> The maximum bit rate of the module depends on the current network settings.

The network automatically configures the channel encoding used by the module, depending on conditions and the quality of the radio link between cell phone and base station. If the channel is very noisy, the network may use the most robust coding scheme (CS-1) to ensure higher reliability. If the channel provides good conditions, the network can use the least robust but fastest coding scheme (CS-4) to obtain optimum speed.

## 1.5 AT command support

The module supports AT commands according to 3GPP standards TS 27.007 [6], 27.005 [7] and 27.010 [8], plus u-blox proprietary AT commands.

 For the complete list of the supported AT commands and their syntax, see the u-blox AT Commands Manual [2].

## 1.6 Supported features

Table 3 lists some of the main features supported by SARA-G450 modules.

Feature	Description
Network Indication	GPIO configured to indicate the network status: registered home network, registered roaming, data call enabled, no service. The network indication feature can be enabled through a custom AT command (see the u-blox AT Commands Manual [2], +UGPIOC AT command).
Antenna Detection	The <b>ANT_DET</b> pin provides antenna presence detection capability, evaluating the resistance from the <b>ANT</b> pin to GND by means of an external antenna detection circuit implemented on the application board. The antenna detection feature can be enabled through a custom AT command (see the u-blox AT Commands Manual [2], +UANTR AT command).
Jamming detection <sup>3</sup>	Detects “artificial” interference that obscures the operator’s carriers providing access to the GSM service and reports the start and stop of such conditions to the application processor (AP). The AP can react appropriately, e.g. by switching off the radio transceiver to reduce power consumption and monitoring the environment at constant periods.
Second AT interface <sup>3</sup>	AT command mode available on both the Primary UART interface and the Secondary Auxiliary UART interface.
Embedded TCP/IP and UDP/IP	Embedded TCP/IP and UDP/IP stack including direct link mode for TCP and UDP sockets. The sockets can be configured in Direct Link mode to establish a transparent end-to-end communication with an already connected TCP or UDP socket via serial interface.
FTP, FTPS	File Transfer Protocol as well as Secure File Transfer Protocol (SSL encryption of FTP control channel) functionalities are supported via AT commands.
HTTP, HTTPS	Hyper-Text Transfer Protocol as well as Secure Hyper-Text Transfer Protocol (SSL encryption) functionalities are supported via AT commands. HEAD, GET, POST, DELETE and PUT operations are available. Up to 4 client contexts can be simultaneously used.
Embedded TLS 1.2	With the support of X.509 certificates, Embedded TLS 1.2 provides server and client authentication, data encryption, data signature and enables TCP/IP applications like HTTPS and FTPS to communicate over a secured and trusted connection. The feature can be configured and enabled by +USECMNG and +USECPRF AT commands.
IPv4/IPv6 dual-stack	Capability to move between IPv4 and dual stack network infrastructures. IPv4 and IPv6 addresses can be used.
GPS/GNSS via modem <sup>3</sup>	Full access to u-blox positioning chips and modules is available through a dedicated DDC (I <sup>2</sup> C) interface. A single serial port from any host processor can control both the u-blox SARA-G450 cellular module and the u-blox positioning chip / module.

<sup>3</sup> Supported by future FW versions

Feature	Description
AssistNow Software <sup>3</sup>	Embedded AssistNow Online and AssistNow Offline clients to provide full developed to provide better GNSS performance and faster Time-to-First-Fix.
CellLocate <sup>®3</sup>	Enables the estimation of device position based on the parameters of the mobile network cells visible to the specific device based on the CellLocate <sup>®</sup> database: <ul style="list-style-type: none"> <li>• Normal scan: parameters of the visible home network cells are only sent</li> <li>• Deep scan: parameters of all surrounding cells of all mobile operators are sent</li> </ul>
Hybrid Positioning <sup>3</sup>	Provides the module's current position using a u-blox positioning chip or module or the estimated position from CellLocate <sup>®</sup> , depending on which positioning method provides the best and fastest solution according to the user configuration.
Firmware update Over AT commands (FOAT)	Firmware module upgrade over the UART interface, using AT command.
Power saving	The power saving configuration is by default disabled, but it can be configured using an AT command. When power saving is enabled, the module automatically enters the low power idle-mode whenever possible, reducing current consumption. During the idle-mode, the module processor core runs with the RTC 32 kHz reference clock, which is generated by the internal 32 kHz oscillator. For more details, see the SARA-G450 System Integration Manual <a href="#">[1]</a> and the u-blox AT Commands Manual <a href="#">[2]</a> , +UPSV AT command

**Table 3: SARA-G450 modules main supported features**



u-blox is extremely mindful of user privacy. When a position is sent to the CellLocate<sup>®</sup> server, u-blox is unable to track the SIM used or the specific device.



## 2 Interfaces

### 2.1 Power management

#### 2.1.1 Module supply input (VCC)

SARA-G450 modules must be supplied through the three **VCC** pins by a DC power supply. Voltages must be stable: during operation, the current drawn from **VCC** can vary by some order of magnitude, especially due to the surging consumption profile of the GSM system (described in the SARA-G450 System Integration Manual [1]).

SARA-G450 modules provide separate supply inputs over the three **VCC** pins:

- **VCC** pins **#52** and **#53** represent the supply input for the internal RF power amplifier, demanding most of the total current drawn of the module when RF transmission is enabled during a call
- **VCC** pin **#51** represents the supply input for the internal baseband Power Management Unit, demanding minor part of the total current drawn of the module when RF transmission is enabled during a call

It is important that the system power supply circuit is able to withstand the maximum pulse current during a transmit burst at maximum power level (see Table 11).

#### 2.1.2 RTC supply input/output (V\_BCKP)

**V\_BCKP** is the Real Time Clock (RTC) supply of SARA-G450 modules. When **VCC** voltage is within the valid operating range, the internal Power Management Unit (PMU) supplies the RTC and the same supply voltage is available on **V\_BCKP** pin. If the **VCC** voltage is under the minimum operating limit (e.g. during not powered mode), **V\_BCKP** pin can externally supply the RTC.

#### 2.1.3 Digital I/O interfaces supply output (V\_INT)

SARA-G450 modules provide supply rail output on the **V\_INT** pin, which is internally generated when the module is switched on. The same voltage domain is used internally to supply the generic digital I/O interfaces of the modules (UART interfaces, I<sup>2</sup>C interface, I<sup>2</sup>S interface and GPIO pins).

The voltage value of the **V\_INT** supply output can be set to 1.8 V or 3 V according to the configuration of the **VSEL** input pin (see section 2.3.4). The **V\_INT** supply output can be used in place of an external regulator.



It is recommended to provide a Test-Point connected to the **V\_INT** pin for diagnostic purpose.

## 2.2 Antenna

### 2.2.1 Antenna RF interface (ANT)

The **ANT** pin has an impedance of 50 Ω and provides the RF antenna interface of SARA-G450 modules.

### 2.2.2 Antenna detection (ANT\_DET)

The **ANT\_DET** pin is an Analog to Digital Converter (ADC) input to sense the antenna presence (as optional feature), evaluating the resistance from the **ANT** pin to GND by means of an external antenna detection circuit implemented on the application board. (For more details, see the SARA-G450 System Integration Manual [1] and the u-blox AT Commands Manual [2], +UANTR AT command.)

## 2.3 System functions

### 2.3.1 Module power-on (PWR\_ON)

SARA-G450 modules can be switched on in one of the following ways:

- Low level on the **PWR\_ON** input pin, i.e. forcing the pin (normally high due to internal pull-up) to a low level for a valid time period (see section 4.2.6). The **PWR\_ON** line is intended to be driven by open drain, open collector or contact switch.
- RTC alarm, i.e. pre-programmed scheduled time (see the u-blox AT Commands Manual [2], AT+CALA)

 It is recommended to provide a Test-Point connected to the **PWR\_ON** pin for diagnostic purpose.

### 2.3.2 Module power-off

SARA-G450 modules can be properly switched off, with storage of current settings and network detach, by:

- AT+CPWROFF command (see the u-blox AT Commands Manual [2]).

An abrupt under-voltage shutdown occurs on SARA-G450 modules when the **VCC** supply drops below the extended operating range minimum limit, but in this case it is not possible to perform the storing of the current parameter settings in the module's non-volatile memory as well as the proper network detach.

An abrupt hardware shutdown occurs when a low level is applied to the **PWR\_OFF** pin, which is normally set high, for a valid time period (see section 4.2.7), but in this case the module does not perform the storing of the current parameter settings as well as the proper network detach. The **PWR\_OFF** line is intended to be driven by open drain, open collector or contact switch.

 It is recommended to provide a test-point connected to the **PWR\_OFF** pin for diagnostic purpose.

### 2.3.3 Module reset

SARA-G450 modules can be properly reset (rebooted), with storage of current parameter settings in the module's non-volatile memory and proper network detach, by:

- AT+CFUN command (see the u-blox AT Commands Manual [2]). This causes an "internal" or "software" reset of the module.

An abrupt hardware shutdown occurs when a low level is applied to the **PWR\_OFF** pin, which is normally set high, for a valid time period (see section 4.2.7), but in this case the module does not perform the storing of the current parameter settings in the module's non-volatile memory as well as the proper network detach. The module can be subsequently rebooted forcing a low level at the **PWR\_ON** input pin for a valid time period (see section 4.2.6).

### 2.3.4 Digital I/O interfaces voltage selection (VSEL)

The digital I/O interfaces of SARA-G450 modules (the UART interfaces, I<sup>2</sup>C interface, I<sup>2</sup>S interface and GPIO pins) can operate at 1.8 V or 3 V voltage rail. The operating voltage can be selected using the **VSEL** input pin:

- If **VSEL** input pin is connected to GND, the digital I/O interfaces operate at 1.8 V
- If **VSEL** input pin is left unconnected, the digital I/O interfaces operate at 3 V

The operating voltage cannot be changed dynamically: the **VSEL** input pin configuration has to be set before the boot of SARA-G450 modules and then it cannot be changed after switched on.

## 2.4 SIM

### 2.4.1 (U)SIM interface

A (U)SIM card interface is available via the **VSIM**, **SIM\_IO**, **SIM\_CLK**, **SIM\_RST** pins of SARA-G450 modules for the direct connection of an external SIM card/chip: the high-speed SIM/ME interface is implemented as well as the automatic detection of the required SIM supporting voltage.

Both 1.8 V and 3 V SIM types are supported: activation and deactivation with automatic voltage switch from 1.8 V to 3 V are implemented, according to ISO-IEC 7816-3 specifications.

### 2.4.2 SIM card detection (SIM\_DET)

The **SIM\_DET** pin of SARA-G450 modules is a digital input provided to sense the SIM card presence (as an optional feature), when it is properly connected to the mechanical switch of the SIM card holder (for more details see the SARA-G450 System Integration Manual [1]).

## 2.5 Serial interfaces

SARA-G450 modules provide the following serial communication interfaces:

- UART interface: 9-wire unbalanced 1.8 V / 3 V asynchronous serial interface supporting
  - AT command mode<sup>4</sup>
  - Data mode and Online command mode<sup>4</sup>
  - MUX functionality
  - FW upgrades by means of the FOAT feature
- Secondary auxiliary UART interface<sup>5</sup>: 3-wire unbalanced 1.8 V / 3 V asynchronous serial interface supporting
  - AT command mode
  - FW upgrades by means of the FOAT feature
- Additional UART interface for FW upgrade and Tracing: 3-wire unbalanced 1.8 V / 3 V asynchronous serial interfaces supporting
  - FW upgrades by means of the dedicated tool
  - Trace log capture (diagnostic purpose)
- DDC interface<sup>5</sup>: I<sup>2</sup>C-bus compatible 1.8 V / 3 V interface

### 2.5.1 Asynchronous serial interface (UART)

The UART interface is a 9-wire unbalanced asynchronous serial interface, supporting:

- AT command mode<sup>4</sup>
- Data mode and online command mode<sup>4</sup>
- MUX functionality
- FW upgrades by means of the FOAT feature

UART characteristics are:

- Complete serial port with RS-232 functionality conforming to ITU-T V.24 Recommendation [5], with CMOS compatible signal levels (0 V for low data bit or ON state and 1.8 V / 3 V for high data bit or OFF state)
- Data lines (**RXD** as output, **TXD** as input), hardware flow control lines (**CTS** as output, **RTS** as input), modem status and control lines (**DTR** as input, **DSR** as output, **DCD** as output, **RI** as output) are provided
- Hardware flow control (default value) or none flow control are supported

<sup>4</sup> See the u-blox AT Commands Manual [2] for the definition of the command mode, data mode, and online command mode.

<sup>5</sup> Not supported by "00" product version.

- Power saving indication available on the hardware flow control output (**CTS** line): the line is driven to the OFF state when the module is in idle mode
- 2400, 4800, 9600, 19200, 38400, 57600, 115200 b/s baud-rates are supported
- One-shot auto baud-rate detection (autobauding) is the default configuration
- Frame format can be: 8N1 (8 data bits, no parity, 1 stop bit), or 8N2 (8 data bits, no parity, 2 stop bits), or 8E1 (8 data bits, even parity, 1 stop bit), or 8O1 (8 data bits, odd parity, 1 stop bit)
- Default frame configuration is 8N1 (8 data bits, no parity, 1 stop bit)

### 2.5.1.1 Multiplexer protocol

SARA-G450 module has a software layer with MUX functionality, 3GPP TS 27.010 [8], available on the UART physical link. This is a data link protocol (layer 2 of OSI model) which uses HDLC-like framing and operates between the module (DCE) and the application processor (DTE), and allows a number of simultaneous sessions over the physical link (UART): the user can concurrently use AT command interface on one MUX channel and data communication on another MUX channel.

SARA-G450 modules define the following virtual channels:

- Channel 0: control channel
- Channel 1 – 5: AT commands / data connection

For more details, see the Mux implementation Application Note [3].

## 2.5.2 Secondary auxiliary asynchronous serial interface (AUX UART)

 Secondary auxiliary UART interface will be supported by future FW versions.

The secondary auxiliary UART interface (AUX UART) is a 3-wire unbalanced asynchronous serial interface, supporting:

- AT command mode
- FW upgrades by means of the FOAT feature

AUX UART characteristics are:

- Serial port with RS-232 functionality conforming to ITU-T V.24 Recommendation [5], with CMOS compatible levels: 0 V for low data bit or ON state and 1.8 V / 3 V for high data bit or OFF state
- Data lines (**RXD\_AUX** as output, **TXD\_AUX** as input)

## 2.5.3 Additional asynchronous serial interface for FW upgrade and Tracing (FT UART)

The additional UART interface for Firmware upgrade and Tracing (FT UART) is a 3-wire unbalanced asynchronous serial interface, supporting:

- FW upgrades by means of the dedicated tool
- Trace log capture (diagnostic purpose)

FT UART characteristics are:

- Serial port with RS-232 functionality conforming to ITU-T V.24 Recommendation [5], with CMOS compatible levels: 0 V for low data bit or ON state and 1.8 V / 3 V for high data bit or OFF state
- Data lines (**RXD\_FT** as output, **TXD\_FT** as input)
- Software flow control (XON/XOFF) or None flow control
- Fixed baud-rate 921600 b/s
- Fixed frame format 8N1 (8 data bits, no parity, 1 stop bit)

 It is highly recommended to provide test-points connected to the **RXD\_FT** and **TXD\_FT** pins for FW upgrades and diagnostic purpose.

## 2.5.4 DDC (I<sup>2</sup>C compatible) interface

 DDC (I<sup>2</sup>C compatible) interface will be supported by future FW versions.

SARA-G450 modules provide an I<sup>2</sup>C compatible DDC interface on the **SCL** and **SDA** pins exclusively for the communication with u-blox GNSS positioning chips / modules.

## 2.6 Audio interfaces

 The audio interfaces will be supported by future FW versions.

SARA-G450 modules provide analog and digital audio interfaces:

- Analog audio input:
  - Differential analog audio input (**MIC\_P**, **MIC\_N**) shared for all the analog audio path modes: the pins can be connected to the output of an external analog audio device or can be connected to an external microphone by means of a simple circuit implemented on the application board
  - Supply output for an external microphone (**MIC\_BIAS**): the pin can provide the bias to an external microphone by means of a simple circuit implemented on the application board
  - Local ground for the external microphone (**MIC\_GND**): the pin can provide the reference for the differential analog audio input as sense ground line for the external microphone circuit
- Analog audio output:
  - Differential audio output (**SPK\_P**, **SPK\_N**) shared for all the analog audio path modes: the pins can be connected to the input of an external analog audio device or can be connected to an external speaker
- I<sup>2</sup>S digital audio interface:
  - 4-wire digital audio interface (**I2S\_TXD**, **I2S\_RXD**, **I2S\_CLK**, **I2S\_WA**)

## 2.7 GPIO

SARA-G450 modules provide 4 GPIO pins (**GPIO1-GPIO4**) that can be configured for general purpose input/output, or to provide custom functions via u-blox AT commands (for further details, see the SARA-G450 System Integration Manual [1] and the u-blox AT Commands Manual [2], +UGPIOC, +UGPIOR, +UGPIOW).

**Table 4** summarizes the custom functions available on the GPIO pins of SARA-G450 modules.

Function	Description	Default GPIO	Configurable GPIOs
Network status indication	Network status: registered home network, registered roaming, data transmission, no service	--	GPIO1, GPIO2, GPIO3, GPIO4
32.768 kHz output	32.768 kHz clock output	--	GPIO3
General purpose input	Input to sense high or low digital level	--	GPIO1, GPIO2, GPIO3, GPIO4
General purpose output	Output to set high or low digital level	--	GPIO1, GPIO2, GPIO3, GPIO4
Pin disabled	Tri-state with an internal active pull-down enabled	GPIO1, GPIO2, GPIO3, GPIO4	GPIO1, GPIO2, GPIO3, GPIO4

**Table 4: GPIO custom functions configuration**

### 3 Pin definition

#### 3.1 Pin assignment

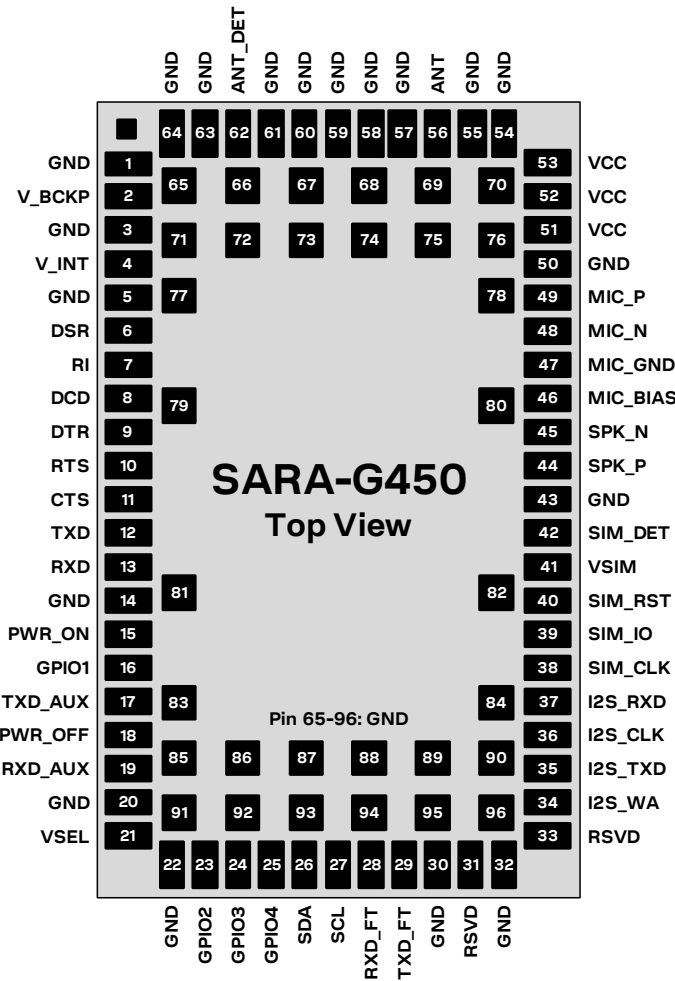

Figure 2: SARA-G450 modules – pin assignments

No	Name	Power domain	I/O	Description	Remarks
1	GND	-	N/A	Ground	All the GND pads must be connected to ground.
2	V_BCKP	-	I/O	Real Time Clock supply input/output	V_BCKP = 3.1 V (typical) generated by the module to supply the Real Time Clock when VCC supply voltage is within valid operating range. See section 4.2.2 for detailed electrical specs.
3	GND	-	N/A	Ground	All the GND pads must be connected to ground.
4	V_INT	-	O	Digital I/O Interfaces supply output	V_INT supply output, rail of the Digital I/O Interfaces, generated by the module when the module is switched-on. V_INT = 1.8 V (typical), if VSEL is connected to GND. V_INT = 3 V (typical), if VSEL is unconnected. Test-point recommended for diagnostic purpose. See section 4.2.2 for detailed electrical specs.
5	GND	-	N/A	Ground	All the GND pads must be connected to ground.

No	Name	Power domain	I/O	Description	Remarks
6	DSR	GDI	O	UART data set ready	Circuit 107 (DSR) in ITU-T V.24. PU/PD class b. Value at reset: T/PD See section 4.2.9 for detailed electrical specs.
7	RI	GDI	O	UART ring indicator	Circuit 125 (RI) in ITU-T V.24. PU/PD class b. Value at reset: T/PD See section 4.2.9 for detailed electrical specs.
8	DCD	GDI	O	UART data carrier detect	Circuit 109 (DCD) in ITU-T V.24. PU/PD class b. Value at reset: T/PD See section 4.2.9 for detailed electrical specs.
9	DTR	GDI	I	UART data terminal ready	Circuit 108/2 (DTR) in ITU-T V.24. Internal active pull-up enabled. PU/PD class b. Value at reset: T/PD See section 4.2.9 for detailed electrical specs.
10	RTS	GDI	I	UART request to send	Circuit 105 (RTS) in ITU-T V.24. Internal active pull-up enabled. PU/PD class b. Value at reset: T/PD See section 4.2.9 for detailed electrical specs.
11	CTS	GDI	O	UART clear to send	Circuit 106 (CTS) in ITU-T V.24. PU/PD class b. Value at reset: T/PD See section 4.2.9 for detailed electrical specs.
12	TXD	GDI	I	UART transmitted data	Circuit 103 (TxD) in ITU-T V.24. Internal active pull-up enabled. PU/PD class b. Value at reset: T/PD See section 4.2.9 for detailed electrical specs.
13	RXD	GDI	O	UART received data	Circuit 104 (RxD) in ITU-T V.24. PU/PD class b. Value at reset: T/PD See section 4.2.9 for detailed electrical specs.
14	GND	-	N/A	Ground	All the GND pads must be connected to ground.
15	PWR_ON	PON	I	Power-on input	Internal active pull-up to 2.5 V internal supply. Test-Point recommended for diagnostic purpose. See section 4.2.6 for detailed electrical specs.
16	GPIO1	GDI	I/O	GPIO	Configurable GPIO: see Table 4 for the available custom functions. PU/PD class a. Value at reset: T/PD See section 4.2.9 for detailed electrical specs.
17	TXD_AUX	GDI	I	AUX UART transmitted data	Circuit 103 (TxD) in ITU-T V.24. Not supported by "00" product version. See section 4.2.9 for detailed electrical specs.
18	PWR_OFF	POF	I	Power-off input	Internally connected to 1.5 V internal supply. Test-Point recommended for diagnostic purpose. See section 4.2.7 for detailed electrical specs.
19	RXD_AUX	GDI	O	AUX UART received data	Circuit 104 (RxD) in ITU-T V.24. Not supported by "00" product version. See section 4.2.9 for detailed electrical specs.
20	GND	-	N/A	Ground	All the GND pads must be connected to ground.
21	VSEL	-	I	Voltage selection	Input to select the operating voltage of the digital I/O interfaces of the module (the UART interfaces, I <sup>2</sup> C interface, I <sup>2</sup> S interface and GPIO pins). V_INT = 1.8 V (typical), if VSEL is connected to GND. V_INT = 3 V (typical), if VSEL is unconnected.
22	GND	-	N/A	Ground	All the GND pads must be connected to ground.

No	Name	Power domain	I/O	Description	Remarks
23	GPIO2	GDI	I/O	GPIO	Configurable GPIO: see <a href="#">Table 4</a> for the available custom functions. PU/PD class b. Value at reset: T/PD See section <a href="#">4.2.9</a> for detailed electrical specs.
24	GPIO3	GDI	I/O	GPIO	Configurable GPIO: see <a href="#">Table 4</a> for the available custom functions. PU/PD class b. Value at reset: T/PD See section <a href="#">4.2.9</a> for detailed electrical specs.
25	GPIO4	GDI	I/O	GPIO	Configurable GPIO: see <a href="#">Table 4</a> for the available custom functions. PU/PD class b. Value at reset: T/PD See section <a href="#">4.2.9</a> for detailed electrical specs.
26	SDA	DDC	I/O	I <sup>2</sup> C bus data line	Fixed open drain. No internal pull-up. Not supported by "00" product version. See section <a href="#">4.2.10</a> for detailed electrical specs.
27	SCL	DDC	O	I <sup>2</sup> C bus clock line	Fixed open drain. No internal pull-up. Not supported by "00" product version. See section <a href="#">4.2.10</a> for detailed electrical specs.
28	RXD_FT	GDI	O	FT UART received data	Circuit 104 (RxD) in ITU-T V.24. PU/PD class b. Value at reset: T/PU Test-Point recommended for diagnostic purpose. See section <a href="#">4.2.9</a> for detailed electrical specs.
29	TXD_FT	GDI	I	FT UART transmitted data	Circuit 103 (TxD) in ITU-T V.24. Internal active pull-up enabled. PU/PD class b. Value at reset: T/PU Test-Point recommended for diagnostic purpose. See section <a href="#">4.2.9</a> for detailed electrical specs.
30	GND	-	N/A	Ground	All the GND pads must be connected to ground.
31	RSVD	-	N/A	RESERVED pin	Internally not connected. Leave unconnected.
32	GND	-	N/A	Ground	All the GND pads must be connected to ground.
33	RSVD	-	N/A	RESERVED pin	This pin can be connected to GND or it can be left unconnected.
34	I2S_WA	GDI	O	I <sup>2</sup> S word alignment	Not supported by "00" product version. See section <a href="#">4.2.9</a> for detailed electrical specs.
35	I2S_TXD	GDI	O	I <sup>2</sup> S transmit data	Not supported by "00" product version. See section <a href="#">4.2.9</a> for detailed electrical specs.
36	I2S_CLK	GDI	O	I <sup>2</sup> S clock	Not supported by "00" product version. See section <a href="#">4.2.9</a> for detailed electrical specs.
37	I2S_RXD	GDI	I	I <sup>2</sup> S receive data	Not supported by "00" product version. See section <a href="#">4.2.9</a> for detailed electrical specs.
38	SIM_CLK	SIM	O	SIM clock	See section <a href="#">4.2.8</a> for detailed electrical specs.
39	SIM_IO	SIM	I/O	SIM data	Internal 4.7k pull-up to VSIM. See section <a href="#">4.2.8</a> for detailed electrical specs.
40	SIM_RST	SIM	O	SIM reset	See section <a href="#">4.2.8</a> for detailed electrical specs.
41	VSIM	-	O	SIM supply output	VSIM = 1.8 V typical, if external SIM = 1.8 V type. VSIM = 2.8 V typical, if external SIM = 3.0 V type. See section <a href="#">4.2.2</a> for detailed electrical specs.
42	SIM_DET	GDI	I	SIM detection	SIM card presence detection function. Internal active pull-down enabled. PU/PD class b. Value at reset: T/PD See section <a href="#">4.2.9</a> for detailed electrical specs.
43	GND	-	N/A	Ground	All the GND pads must be connected to ground.







No	Name	Power domain	I/O	Description	Remarks
44	SPK_P	AUDIO	O	Differential analog audio output (positive)	Differential analog audio output. Not supported by "00" product version.
45	SPK_N	AUDIO	O	Differential analog audio output (negative)	Differential analog audio output. Not supported by "00" product version.
46	MIC_BIAS	AUDIO	O	Microphone supply output	Supply output for the external microphone. Not supported by "00" product version.
47	MIC_GND	AUDIO	I	Microphone analog reference	Local ground for the external microphone (reference for the differential analog audio input). Not supported by "00" product version.
48	MIC_N	AUDIO	I	Differential analog audio input (negative)	Differential analog audio input. Not supported by "00" product version.
49	MIC_P	AUDIO	I	Differential analog audio input (positive)	Differential analog audio input. Not supported by "00" product version.
50	GND	-	N/A	Ground	All the GND pads must be connected to ground.
51	VCC	-	I	Module supply input	All VCC pins must be connected to external supply. Supply input for internal Base-Band PMU and transceiver. See sections <a href="#">4.2.2</a> , <a href="#">4.2.3</a> for detailed electrical spec.
52	VCC	-	I	Module supply input	All VCC pins must be connected to external supply. Supply input for the internal RF Power Amplifier. See sections <a href="#">4.2.2</a> , <a href="#">4.2.3</a> for detailed electrical spec.
53	VCC	-	I	Module supply input	All VCC pins must be connected to external supply. Supply input for the internal RF Power Amplifier. See sections <a href="#">4.2.2</a> , <a href="#">4.2.3</a> for detailed electrical spec.
54	GND	-	N/A	Ground	All the GND pads must be connected to ground.
55	GND	-	N/A	Ground	All the GND pads must be connected to ground.
56	ANT	-	I/O	RF antenna	50 $\Omega$ nominal impedance See section <a href="#">4.2.4</a> for detailed electrical specs.
57	GND	-	N/A	Ground	All the GND pads must be connected to ground.
58	GND	-	N/A	Ground	All the GND pads must be connected to ground.
59	GND	-	N/A	Ground	All the GND pads must be connected to ground.
60	GND	-	N/A	Ground	All the GND pads must be connected to ground.
61	GND	-	N/A	Ground	All the GND pads must be connected to ground.
62	ANT_DET	ADC	I	Antenna detection	Antenna presence detection function. See section <a href="#">4.2.5</a> for detailed electrical specs.
63	GND	-	N/A	Ground	All the GND pads must be connected to ground.
64	GND	-	N/A	Ground	All the GND pads must be connected to ground.
65-96	GND	-	N/A	Ground	All the GND pads must be connected to ground.

**Table 5: SARA-G450 module pin-out**

 For an explanation of abbreviations and terms used, see [Appendix A](#).

## 4 Electrical specifications

-  Stressing the device above one or more of the ratings listed in the Absolute Maximum Rating section may cause permanent damage. These are stress ratings only. Operating the module at these or at any conditions other than those specified in the Operating Conditions sections (chapter 4.2) of the specification should be avoided. Exposure to Absolute Maximum Rating conditions for extended periods may affect device reliability.
-  Operating conditions ranges define those limits within which the functionality of the device is guaranteed.
-  Electrical characteristics are defined according to the verification on a representative number of samples or according to the simulation.
-  Where application information is given, it is advisory only and does not form part of the specification.

### 4.1 Absolute maximum rating

-  Limiting values given below are in accordance with Absolute Maximum Rating System (IEC 134).

Symbol	Description	Condition	Min	Max	Unit
VCC	Module supply voltage	Input DC voltage at VCC pins	-0.15	5.0	V
V_BCKP	RTC supply voltage	Input DC voltage at V_BCKP pin	-0.15	3.5	V
GDI	Generic digital interfaces	Input DC voltage at Generic digital interfaces pins	-0.15	3.3	V
DDC	DDC interface	Input DC voltage at DDC interface pins	-0.15	3.3	V
SIM	SIM interface	Input DC voltage at SIM interface pins	-0.15	3.3	V
PON	Power-on signal	Input DC voltage at PWR_ON pin	-0.15	5.0	V
POF	Power-off signal	Input DC voltage at PWR_OFF pin	-0.15	5.0	V
ADC	Antenna detection pin	Input DC voltage at ANT_DET pin	-0.15	2.3	V
Rho_ANT	Antenna ruggedness	Output RF load mismatch ruggedness at ANT pin		20:1	VSWR
Tstg	Storage temperature range		-40	+85	°C

**Table 6: Absolute maximum ratings**

-  The product is not protected against overvoltage or reversed voltages. If necessary, voltage spikes exceeding the voltage specifications, given in table above, must be limited to values within the specified boundaries by using appropriate protection devices.



#### 4.1.1 Maximum ESD

Parameter	Min	Typical	Max	Unit	Remarks
ESD sensitivity for all pins except ANT pin			1000	V	Human Body Model according to JESD22-A114
ESD sensitivity for ANT pin			1000	V	Human Body Model according to JESD22-A114
ESD immunity for ANT pin			4000	V	Contact Discharge according to IEC 61000-4-2
			8000	V	Air Discharge according to IEC 61000-4-2

**Table 7: Maximum ESD ratings**

-  u-blox cellular modules are Electrostatic Sensitive Devices (ESD) and require special precautions when handling. See section 7.4 for ESD handling instructions.

## 4.2 Operating conditions

-  Unless otherwise specified, all operating condition specifications are at an ambient temperature of 25°C.
-  Operation beyond the operating conditions is not recommended and extended exposure beyond them may affect device reliability.

### 4.2.1 Operating temperature range

Parameter	Min	Typical	Max	Unit	Remarks
Normal operating temperature	-20	+25	+70	°C	Normal operating temperature range (fully functional and meet 3GPP specifications)
Extended operating temperature	-40		+75	°C	Extended operating temperature range (RF performance may be affected outside normal operating range, though module is fully functional)

Table 8: Environmental conditions

### 4.2.2 Supply/Power pins

Symbol	Parameter	Min	Typical	Max	Unit
VCC	Module supply normal operating voltage <sup>6</sup>	3.4	3.8	4.2	V
	Module supply extended operating voltage <sup>7</sup>	3.1		4.5	V
V_BCKP	Real Time Clock Supply input voltage	2.6		3.3	V
I_BCKP	Real Time Clock Supply average current consumption, at V_BCKP = 3.1 V		185		µA

Table 9: Input characteristics of Supply/Power pins

Symbol	Parameter	Min	Typical	Max	Unit
VSIM	SIM interface supply output voltage, external SIM = 1.8V type		1.80		V
	SIM interface supply output voltage, external SIM = 3.0V type		2.80		V
V_BCKP	Real Time Clock supply output voltage		3.1		V
I_BCKP	Real Time Clock supply output current capability			1.6	mA
V_INT	Digital I/O Interfaces supply output voltage, VSEL = GND		1.80		V
	Digital I/O Interfaces supply output voltage, VSEL unconnected		3.00		V
I_INT	Digital I/O Interfaces supply output current capability			70	mA

Table 10: Output characteristics of Supply/Power pins

<sup>6</sup> The input voltage at the related **VCC** pins of the module must be within normal operating range limits to switch-on the module. RF performance may be affected when the input voltage at the **VCC** pins of the module goes outside the normal operating range limits, though the module is still fully functional.

<sup>7</sup> Module may switch off when the input voltage at the related **VCC** pins of the module drops below the extended operating range minimum limit.

### 4.2.3 Current consumption

Mode	Condition	Tx power	Min	Typical <sup>8</sup>	Max <sup>9</sup>	Unit
Power Off Mode (module switched off)	Averaged current value	--		0.1		mA
Idle-Mode (low power mode enabled)	Averaged current value (AT+UPSV=1, AT+COPS=2)	--		1.0		mA
Cyclic Idle/Active-Mode (low power mode enabled)	Averaged current value (AT+UPSV=2, DRX = 9 <sup>10</sup> )	--		1.2		mA
	Averaged current value (AT+UPSV=1, DRX = 5 <sup>11</sup> )	--		1.5		mA
Active-Mode (low power mode disabled)	Averaged current value (AT+UPSV=0, DRX = 5 <sup>11</sup> )	--		8.9		mA
Connected Mode (Tx / Rx call in progress)	Averaged current value, 850 MHz / 900 MHz operating bands, 1 Tx + 1 Rx slot	Minimum		65		mA
	Averaged current value, 1800 MHz / 1900 MHz operating bands, 1 Tx + 1 Rx slot	Minimum		65		mA
	Averaged current value, 850 MHz / 900 MHz operating bands, 1 Tx + 1 Rx slot	Maximum		230		mA
	Averaged current value, 1800 MHz / 1900 MHz operating bands, 1 Tx + 1 Rx slot	Maximum		150		mA
	Pulse current value <sup>12</sup> during 1-slot Tx burst, 850 MHz / 900 MHz operating bands	Maximum		1.5	1.9	A

Table 11: VCC current consumption

### 4.2.4 RF performance

Parameter		Min	Max	Unit	Remarks
Frequency range GSM 850	Uplink	824	849	MHz	Module transmit
	Downlink	869	894	MHz	Module receive
Frequency range E-GSM 900	Uplink	880	915	MHz	Module transmit
	Downlink	925	960	MHz	Module receive
Frequency range DCS 1800	Uplink	1710	1785	MHz	Module transmit
	Downlink	1805	1880	MHz	Module receive
Frequency range PCS 1900	Uplink	1850	1910	MHz	Module transmit
	Downlink	1930	1990	MHz	Module receive

Table 12: Operating RF frequency bands

<sup>8</sup> Typical values with a matched antenna.

<sup>9</sup> Maximum values with a mismatched antenna.

<sup>10</sup> Module is registered with the network, with a paging period of 2.12 s (2G network DRX setting = 9).

<sup>11</sup> Module is registered with the network, with a paging period of 1.18 s (2G network DRX setting = 5).

<sup>12</sup> Use this figure to dimension maximum current capability of power supply.

Parameter	Min	Typical	Max	Unit	Remarks
Receiver input sensitivity: GSM 850		-109		dBm	Downlink RF level @ BER Class II < 2.4 %
Receiver input sensitivity: E-GSM 900		-109		dBm	Downlink RF level @ BER Class II < 2.4 %
Receiver input sensitivity: DCS 1800		-109		dBm	Downlink RF level @ BER Class II < 2.4 %
Receiver input sensitivity: PCS 1900		-109		dBm	Downlink RF level @ BER Class II < 2.4 %

Condition: 50  $\Omega$  source

**Table 13: Receiver sensitivity performance**

## 4.2.5 ANT\_DET pin

Pin Name	Parameter	Min	Typical	Max	Unit	Remarks
ANT_DET	Output DC current pulse value		75		$\mu$ A	
	Output DC current pulse time length	12	13	14	ms	

**Table 14: ANT\_DET pin characteristics**

## 4.2.6 PWR\_ON pin

Pin Name	Parameter	Min	Typical	Max	Unit	Remarks
PWR_ON	Supply for Power-On Input Signal		2.5		V	Internal supply
	Pull-up resistance		28		k $\Omega$	Internal active pull-up
	L-level input	0.0		0.3	V	
	H-level input	1.8		2.5	V	
	L-level input current		86		$\mu$ A	
	PWR_ON low time to switch-on the module	2			s	

**Table 15: PWR\_ON pin characteristics**

## 4.2.7 PWR\_OFF pin

Pin Name	Parameter	Min	Typical	Max	Unit	Remarks
PWR_OFF	Supply for Power-Off Input Signal		1.5		V	Internal supply
	L-level input	0.0		0.1	V	
	H-level input	1.2		1.5	V	
	PWR_OFF low time to switch-off the module	100			ms	

**Table 16: PWR\_OFF pin characteristics**

## 4.2.8 SIM pins

Parameter	Min	Typical	Max	Unit	Remarks
Low-level input	0.00		0.48	V	External SIM type = 1.8 V
	0.00		0.78	V	External SIM type = 3.0 V
High-level input	1.40		2.00	V	External SIM type = 1.8 V
	2.10		3.00	V	External SIM type = 3.0 V
Low-level output	0.00			V	External SIM type = 1.8 V
	0.00			V	External SIM type = 3.0 V
High-level output	1.80			V	External SIM type = 1.8 V
	2.80			V	External SIM type = 3.0 V
Internal pull-up resistor on SIM_IO to VSIM	4.7			k $\Omega$	
Clock frequency on SIM_CLK	3.25			MHz	

**Table 17: SIM pins characteristics**

## 4.2.9 Generic Digital Interfaces pins

Parameter	Min	Typical	Max	Unit	Remarks
Internal supply for GDI domain	1.80			V	Digital Interfaces supply (V_INT). VSEL connected to GND
	3.00			V	Digital Interfaces supply (V_INT). VSEL unconnected
Low-level input	0.00		0.48	V	VSEL connected to GND
	0.00		0.84	V	VSEL unconnected
High-level input	1.40		2.00	V	VSEL connected to GND
	2.24		3.20	V	VSEL unconnected
Low-level output		0.00		V	VSEL connected to GND
		0.00		V	VSEL unconnected
High-level output		1.80		V	VSEL connected to GND
		3.00		V	VSEL unconnected
Output driver strength			3	mA	
Pull-up / Pull-down value		33		k $\Omega$	PU/PD class a
		166		k $\Omega$	PU/PD class b

**Table 18: GDI pins characteristics**

## 4.2.10 DDC (I<sup>2</sup>C) pins

Parameter	Min	Typical	Max	Unit	Remarks
Internal supply for GDI domain	1.80			V	Digital Interfaces supply (V_INT). VSEL connected to GND
	3.00			V	Digital Interfaces supply (V_INT). VSEL unconnected
Low-level input	0.00		0.48	V	VSEL connected to GND
	0.00		0.84	V	VSEL unconnected
High-level input	1.40		2.00	V	VSEL connected to GND
	2.24		3.20	V	VSEL unconnected
Low-level output		0.00		V	VSEL connected to GND
		0.00		V	VSEL unconnected
High-level output		1.80		V	VSEL connected to GND
		3.00		V	VSEL unconnected
Output driver strength			3	mA	
Clock frequency on SCL		100		kHz	

**Table 19: DDC pins characteristics**

# 5 Mechanical specifications

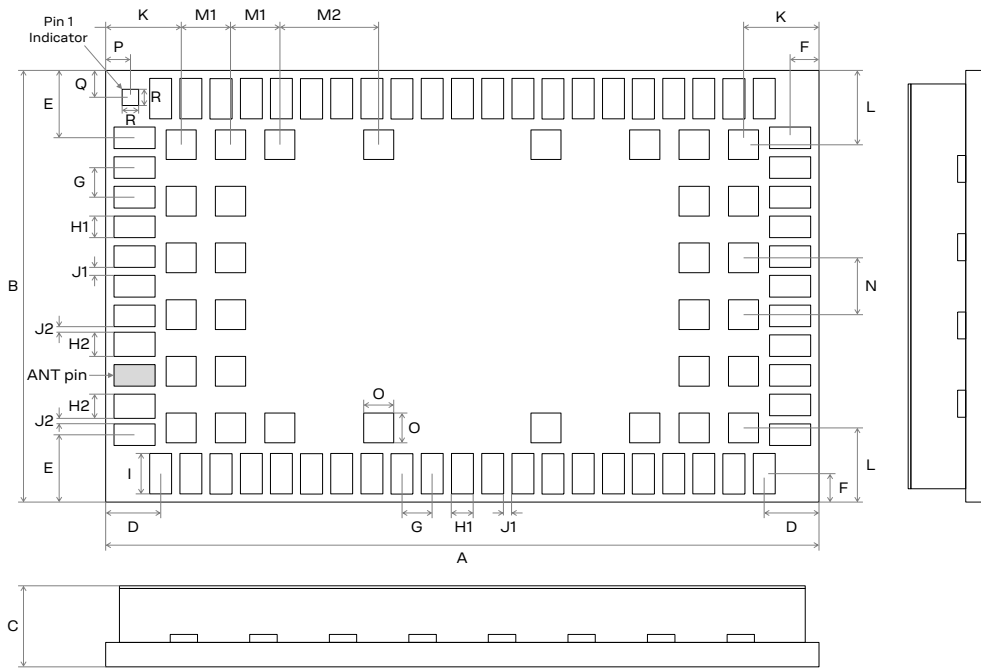





Figure 3: SARA-G450 module dimensions (bottom and sides views)

Parameter	Description	Typical	Tolerance
A	Module Height [mm]	26.0 (1023.6 mil)	+0.20/-0.20 (+7.9/-7.9 mil)
B	Module Width [mm]	16.0 (629.9 mil)	+0.20/-0.20 (+7.9/-7.9 mil)
C	Module Thickness [mm]	2.4 (94.5 mil)	+0.25/-0.15 (+9.8/-5.9 mil)
D	Horizontal Edge to Lateral Pin Pitch [mm]	2.0 (78.7 mil)	+0.20/-0.20 (+7.9/-7.9 mil)
E	Vertical Edge to Lateral Pin Pitch [mm]	2.5 (98.4 mil)	+0.20/-0.20 (+7.9/-7.9 mil)
F	Edge to Lateral Pin Pitch [mm]	1.05 (41.3 mil)	+0.20/-0.20 (+7.9/-7.9 mil)
G	Lateral Pin to Pin Pitch [mm]	1.1 (43.3 mil)	+0.02/-0.02 (+0.8/-0.8 mil)
H1	Lateral Pin Height [mm]	0.8 (31.5 mil)	+0.02/-0.02 (+0.8/-0.8 mil)
H2	Lateral Pin close to ANT Height [mm]	0.9 (35.4 mil)	+0.02/-0.02 (+0.8/-0.8 mil)
I	Lateral Pin Width [mm]	1.5 (59.1 mil)	+0.02/-0.02 (+0.8/-0.8 mil)
J1	Lateral Pin to Pin Distance [mm]	0.3 (11.8 mil)	+0.02/-0.02 (+0.8/-0.8 mil)
J2	Lateral Pin to Pin close to ANT Distance [mm]	0.2 (7.9 mil)	+0.02/-0.02 (+0.8/-0.8 mil)
K	Horizontal Edge to Central Pin Pitch [mm]	2.75 (108.3 mil)	+0.20/-0.20 (+7.9/-7.9 mil)
L	Vertical Edge to Central Pin Pitch [mm]	2.75 (108.3 mil)	+0.20/-0.20 (+7.9/-7.9 mil)
M1	Central Pin to Pin Horizontal Pitch [mm]	1.8 (70.9 mil)	+0.02/-0.02 (+0.8/-0.8 mil)
M2	Central Pin to Pin Horizontal Pitch [mm]	3.6 (141.7 mil)	+0.02/-0.02 (+0.8/-0.8 mil)
N	Central Pin to Pin Vertical Pitch [mm]	2.1 (82.7 mil)	+0.02/-0.02 (+0.8/-0.8 mil)
O	Central Pin Height and Width [mm]	1.1 (43.3 mil)	+0.02/-0.02 (+0.8/-0.8 mil)
P	Horizontal Edge to Pin 1 Indicator Pitch [mm]	0.9 (35.4 mil)	+0.20/-0.20 (+7.9/-7.9 mil)
Q	Vertical Edge to Pin 1 Indicator Pitch [mm]	1.0 (39.4 mil)	+0.20/-0.20 (+7.9/-7.9 mil)
R	Pin 1 Indicator Height and Width [mm]	0.6 (23.6 mil)	+0.02/-0.02 (+0.8/-0.8 mil)
Weight	Module Weight [g]	< 3	

Table 20: SARA-G450 module dimensions

-  Module Height tolerance  $\pm 0.20$  mm may be exceeded close to the corners of the PCB due to cutting process: in worst case the Height could be  $+0.40$  mm longer than the typical value.
-  All the pads of SARA-G450 modules are designed with Cu base material and electroless nickel immersion gold surface finish ( $\text{Ni} > 2.54 \mu\text{m} / \text{Au} > 0.03 \mu\text{m}$ ).
-  For information regarding suggested footprint (copper mask) and stencil (paste mask) layout to be implemented on the application board, see the SARA-G450 System Integration Manual [\[1\]](#).



## 6 Qualification and approvals

### 6.1 Reliability tests

Tests for product family qualifications are according to ISO 16750 “Road vehicles - Environmental conditions and testing for electrical and electronic equipment“, and appropriate standards.

### 6.2 Approvals



Products marked with this lead-free symbol on the product label comply with the “Directive 2002/95/EC of the European Parliament and the Council on the Restriction of Use of certain Hazardous Substances in Electrical and Electronic Equipment” RoHS).

SARA-G450 GSM/GPRS modules are RoHS compliant.

No natural rubbers, hygroscopic materials, or materials containing asbestos are employed.

[Table 21](#) lists the SARA-G450 modules main approvals.

Certification scheme	SARA-G450
GCF (Global Certification Forum)	•
CE (European Conformity)	•
Anatel (Agência Nacional de Telecomunicações Brazil)	•
CCC (Chinese Compulsory Certification)	•
SRRC (State Radio Regulation of China)	•
ICASA (Independent Communications Authority South Africa)	•

**Table 21: SARA-G450 main certification approvals**

For the complete list of approvals and for specific details on all country and network operators’ certifications, see our website ([www.u-blox.com](http://www.u-blox.com)) or contact the u-blox office or sales representative nearest you.

## 7 Product handling

### 7.1 Packaging

SARA-G450 modules are delivered as hermetically sealed, reeled tapes to enable efficient production, production lot set-up and tear-down. For more information about packaging, see the u-blox Package Information Guide [\[4\]](#).



Figure 4: Reeled SARA-G450 modules

#### 7.1.1 Reels

SARA-G450 modules are deliverable in quantities of 250 pieces on a reel. SARA-G450 modules are delivered using reel Type B2 as described in the u-blox Package Information Guide [\[4\]](#).

Parameter	Specification
Reel type	B2
Delivery quantity	250

Table 22: Reel information for SARA-G450 modules



Quantities of less than 250 pieces are also available. Contact u-blox for more information.

## 7.1.2 Tapes

Figure 5 and Table 23 specify the dimensions of the tapes for SARA-G450 module.

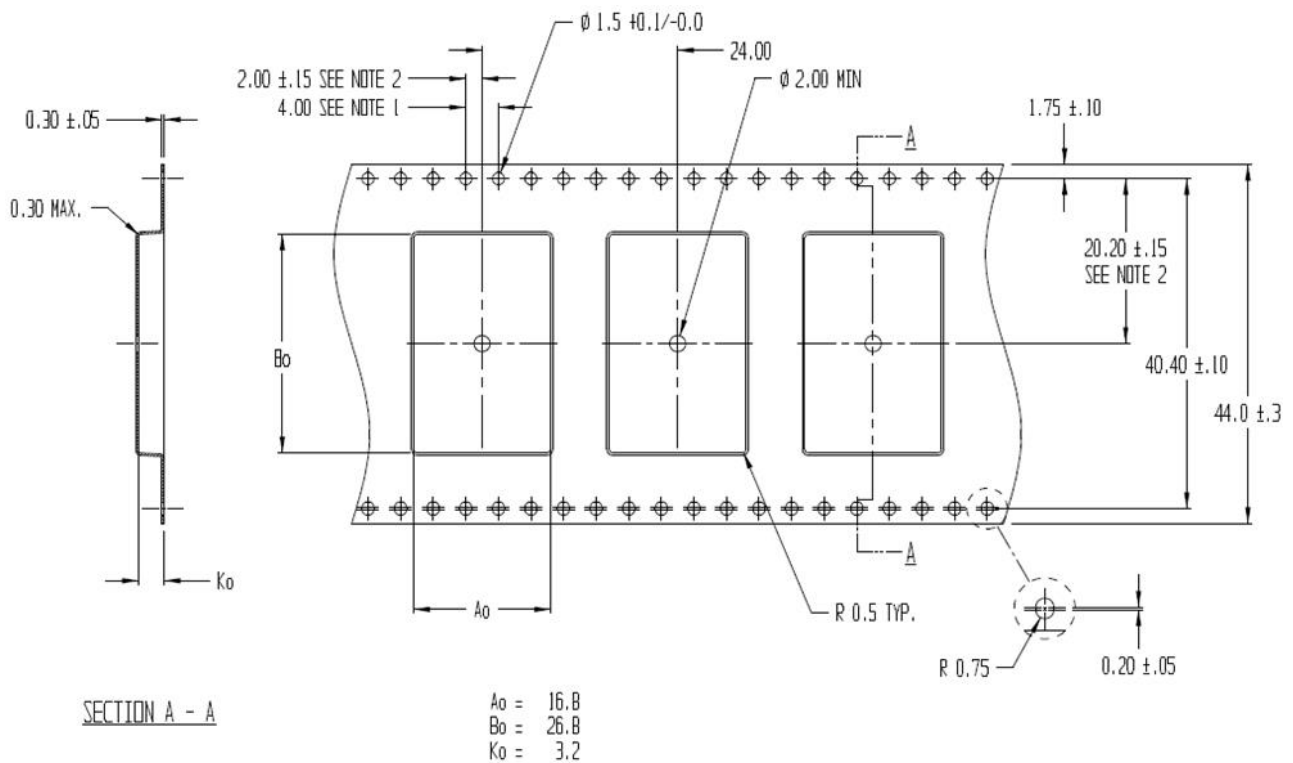

Figure 5: Dimensions for SARA-G450 modules on tape

Parameter	Typical value	Tolerance	Unit
$A_0$	16.8	$\pm 0.2$	mm
$B_0$	26.8	$\pm 0.2$	mm
$K_0$	3.2	$\pm 0.2$	mm

Table 23: SARA-G450 module tape dimensions

- Note 1: 10 sprocket hole pitch cumulative tolerance  $\pm 0.2$  mm.
- Note 2: Pocket position relative to sprocket hole measured as true position of pocket, not pocket hole.
- Note 3:  $A_0$  and  $B_0$  are calculated on a plane at a distance “R” above the bottom of the pocket.

## 7.2 Moisture sensitivity levels

-  SARA-G450 modules are Moisture Sensitive Devices (MSD) in accordance to the IPC/JEDEC specification.

The Moisture Sensitivity Level (MSL) relates to the packaging and handling precautions required. SARA-G450 modules are rated at MSL level 4. For more information regarding moisture sensitivity levels, labeling, storage and drying see the u-blox Package Information Guide [4].



-  For MSL standard see IPC/JEDEC J-STD-020 (can be downloaded from [www.jedec.org](http://www.jedec.org)).

## 7.3 Reflow soldering

Reflow profiles are to be selected according to u-blox recommendations (see SARA-G450 System Integration Manual [1]).

-  Failure to observe these precautions can result in severe damage to the device!

## 7.4 ESD precautions

-  SARA-G450 modules contain highly sensitive electronic circuitry and are Electrostatic Sensitive Devices (ESD). Handling SARA-G450 modules without proper ESD protection may destroy or damage them permanently.
-  Ensure ESD precautions are implemented during handling of the module.



SARA-G450 modules are Electrostatic Sensitive Devices (ESD) and require special ESD precautions typically applied to ESD sensitive components.

Table 7 reports the maximum ESD ratings of the SARA-G450 modules.

Proper ESD handling and packaging procedures must be applied throughout the processing, handling and operation of any application that incorporates SARA-G450 modules.

ESD precautions should be implemented on the application board where the module is mounted, as described in the SARA-G450 System Integration Manual [1].

-  Failure to observe these precautions can result in severe damage to the device!

## 8 Default settings

Interface	Settings	Comments
UART interface	AT interface: enabled	AT command interface is by default enabled on the UART physical interface
	AT+IPR=0	One-shot automatic baud-rate detection enabled by default
	AT+ICF=3	Frame format 8N1 (8 data bits, No parity, 1 stop bit) enabled by default
	AT&K3	HW flow control enabled
	AT&S1	DSR line set ON in data mode <sup>13</sup> and set OFF in command mode <sup>13</sup>
	AT&D1	Upon an ON-to-OFF transition of DTR, the DCE enters online command mode <sup>13</sup> and issues an OK result code
	AT&C1	Circuit 109 changes in accordance with the Carrier detect status; ON if the Carrier is detected, OFF otherwise
	MUX protocol: disabled	Multiplexing mode is by default disabled and it can be configured by AT+CMUX command. The following virtual channels are defined: <ul style="list-style-type: none"> <li>• Channel 0: control channel</li> <li>• Channel 1 – 5: AT commands / data connection</li> </ul>
Power Saving	AT+UPSV=0	Disabled
Network registration	AT+COPS=0	Self network registration

**Table 24: SARA-G450 module default settings**

<sup>13</sup> See the u-blox AT Commands Manual [2] for the definition of command mode, data mode, and online command mode.

## 9 Labeling and ordering information

### 9.1 Product labeling

Figure 6 illustrates the label of the SARA-G450 modules, including: u-blox logo, production lot, Pb-free marking, product Type Number, IMEI number, certification info, and production country.

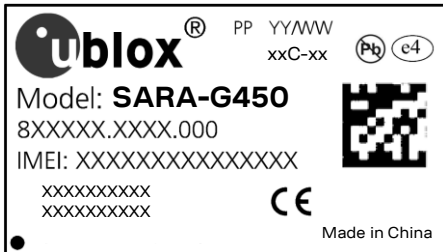



Figure 6: Label of SARA-G450 modules

 For information about the approval codes and for all the certificates of SARA-G450 module compliancy, see our website ([www.u-blox.com](http://www.u-blox.com)), or please contact the u-blox office or sales representative nearest you.

### 9.2 Explanation of codes

Three different product code formats are used. The **Product Name** is used in documentation such as this data sheet and identifies all u-blox products, independent of packaging and quality grade. The **Ordering Code** includes options and quality, while the **Type Number** includes the hardware and firmware versions. Table 25 below details these three different formats:

Format	Structure
Product Name	PPP(P)-TGVV(D)
Ordering Code	PPP(P)-TGVV(D)-TTQ
Type Number	PPP(P)-TGVV(D)-TTQ-XX

Table 25: Product Code Formats

Table 26 explains the parts of the product code.

Code	Meaning	Example
PPP(P)	Form factor	SARA
TG	Platform (Technology and Generation) <ul style="list-style-type: none"> <li>• Dominant technology: G: GSM; U: HSUPA; C: CDMA 1xRTT; N: NB-IoT; R: LTE low data rate (Cat 1 and below); L: LTE high data rate (Cat 3 and above)</li> <li>• Generation within the technology: 1...9</li> </ul>	G4
VV	Variant based on the same platform: 00...99	50
(D)	Optional LTE category: 6,4,3,1,M ...	
TT	Product Version: 00...99	00
Q	Product grade <ul style="list-style-type: none"> <li>• A = automotive</li> <li>• B = professional</li> <li>• C = standard</li> </ul>	C
XX		Default value is 00

Table 26: Part identification code

## 9.3 Ordering information

Ordering No.	Description
SARA-G450-00C	4-band GSM/GPRS module, Standard grade, 26.0 x 16.0 x 2.4 mm, 250 pcs/reel

Table 27: Product ordering codes

# Appendix

## A Glossary

Abbreviation	Definition
ADC	Analog to Digital Converter
AT	AT Command Interpreter Software Subsystem, or attention
BB	Base-Band
BER	Bit Error Rate
DCE	Data Communication Equipment
DDC	Display Data Channel (I <sup>2</sup> C compatible) Interface
DL	Down-link (Reception)
DRX	Discontinuous Reception
DTE	Data Terminal Equipment
GDI	Generic Digital Interfaces (power domain)
GND	Ground
GNSS	Global Navigation Satellite System
GPIO	General Purpose Input Output
GPRS	General Packet Radio Service
GPS	Global Positioning System
GSM	Global System for Mobile Communication
H	High logic digital level
HBM	Human Body Model
I <sup>2</sup> C	Inter-Integrated Circuit Interface
I <sup>2</sup> S	Inter-IC Sound Interface
L	Low logic digital level
LGA	Land Grid Array
LPWA	Low Power Wide Area
N/A	Not Applicable
OD	Open Drain
PA	Power Amplifier
PCN	Product Change Notification / Information Note / Sample Delivery Note
PD	Pull-Down
PMU	Power Management Unit
POF	Power-Off Input Signal
PON	Power-On Input Signal
PU	Pull-Up
RMC	Reference Measurement Channel
SAW	Surface Acoustic Wave
SIM	Subscriber Identity Module
SPI	Serial Peripheral Interface
T	Tristate (Output of the pin set to tri-state, i.e. high impedance state)
T/PD	Tristate with internal active Pull-Down enabled
T/PU	Tristate with internal active Pull-Up enabled
TBD	To Be Defined
UART	Universal Asynchronous Receiver-Transmitter serial interface



Abbreviation	Definition
UL	Up-link (Transmission)
USB	Universal Serial Bus interface

**Table 28: Explanation of the abbreviations and terms used**

## Related documents

- [1] u-blox SARA-G450 System Integration Manual, Docu No UBX-18046432
- [2] u-blox AT Commands Manual, Docu No UBX-13002752
- [3] u-blox MUX implementation Application Note, Docu No UBX-13001887
- [4] u-blox Package Information Guide, Docu No UBX-14001652
- [5] ITU-T Recommendation V24, 02-2000. List of definitions for interchange circuits between Data Terminal Equipment (DTE) and Data Connection Equipment (DCE)
- [6] 3GPP TS 27.007 – Technical Specification Group Core Network and Terminals; AT command set for User Equipment (UE)
- [7] 3GPP TS 27.005 – Technical Specification Group Terminals; Use of Data Terminal Equipment – Data Circuit terminating Equipment (DTE-DCE) interface for Short Message Services (SMS) and Cell Broadcast Service (CBS)
- [8] 3GPP TS 27.010 – Terminal Equipment to User Equipment (TE-UE) multiplexer protocol



For regular updates to u-blox documentation and to receive product change notifications, register on our homepage ([www.u-blox.com](http://www.u-blox.com)).

## Revision history

Revision	Date	Name	Status / Comments
R01	22-Jan-2018	sses	Initial release
R02	12-Apr-2018	sses	Updated pin 18 name from RESET_N to PWR_OFF. Updated module power on, power off and reset sections. Added 32 kHz clock output alternative function of GPIO3. Added V_BCKP characteristics.
R03	31-Aug-2018	fvid / sses / lpah	Document rebranded. Added electrical characteristics of UART interfaces, generic digital interfaces, ANT_DET, PWR_ON, PWR_OFF pins and other info. Updated V_INT, digital I/O electrical characteristics Added current consumption figures. Updated <a href="#">Functional description</a> and <a href="#">GPIO</a> sections. Updated SARA-G450-00C product status to prototype.
R04	19-Oct-2018	fvid / sses	Updated SARA-G450-00C product status to Engineering Sample
R05	30-Nov-2018	fvid	Updated SARA-G450-00C product status to Initial Production

# Contact

For complete contact information, visit us at [www.u-blox.com](http://www.u-blox.com).

## u-blox Offices

### North, Central and South America

#### u-blox America, Inc.

Phone: +1 703 483 3180  
E-mail: [info\\_us@u-blox.com](mailto:info_us@u-blox.com)

#### Regional Office West Coast:

Phone: +1 408 573 3640  
E-mail: [info\\_us@u-blox.com](mailto:info_us@u-blox.com)

#### Technical Support:

Phone: +1 703 483 3185  
E-mail: [support@u-blox.com](mailto:support@u-blox.com)

### Headquarters

#### Europe, Middle East, Africa

#### u-blox AG

Phone: +41 44 722 74 44  
E-mail: [info@u-blox.com](mailto:info@u-blox.com)  
Support: [support@u-blox.com](mailto:support@u-blox.com)

### Asia, Australia, Pacific

#### u-blox Singapore Pte. Ltd.

Phone: +65 6734 3811  
E-mail: [info\\_ap@u-blox.com](mailto:info_ap@u-blox.com)  
Support: [support\\_ap@u-blox.com](mailto:support_ap@u-blox.com)

#### Regional Office Australia:

Phone: +61 2 8448 2016  
E-mail: [info\\_anz@u-blox.com](mailto:info_anz@u-blox.com)  
Support: [support\\_ap@u-blox.com](mailto:support_ap@u-blox.com)

#### Regional Office China (Beijing):

Phone: +86 10 68 133 545  
E-mail: [info\\_cn@u-blox.com](mailto:info_cn@u-blox.com)  
Support: [support\\_cn@u-blox.com](mailto:support_cn@u-blox.com)

#### Regional Office China (Chongqing):

Phone: +86 23 6815 1588  
E-mail: [info\\_cn@u-blox.com](mailto:info_cn@u-blox.com)  
Support: [support\\_cn@u-blox.com](mailto:support_cn@u-blox.com)

#### Regional Office China (Shanghai):

Phone: +86 21 6090 4832  
E-mail: [info\\_cn@u-blox.com](mailto:info_cn@u-blox.com)  
Support: [support\\_cn@u-blox.com](mailto:support_cn@u-blox.com)

#### Regional Office China (Shenzhen):

Phone: +86 755 8627 1083  
E-mail: [info\\_cn@u-blox.com](mailto:info_cn@u-blox.com)  
Support: [support\\_cn@u-blox.com](mailto:support_cn@u-blox.com)

#### Regional Office India:

Phone: +91 80 405 092 00  
E-mail: [info\\_in@u-blox.com](mailto:info_in@u-blox.com)  
Support: [support\\_in@u-blox.com](mailto:support_in@u-blox.com)

#### Regional Office Japan (Osaka):

Phone: +81 6 6941 3660  
E-mail: [info\\_jp@u-blox.com](mailto:info_jp@u-blox.com)  
Support: [support\\_jp@u-blox.com](mailto:support_jp@u-blox.com)

#### Regional Office Japan (Tokyo):

Phone: +81 3 5775 3850  
E-mail: [info\\_jp@u-blox.com](mailto:info_jp@u-blox.com)  
Support: [support\\_jp@u-blox.com](mailto:support_jp@u-blox.com)

#### Regional Office Korea:

Phone: +82 2 542 0861  
E-mail: [info\\_kr@u-blox.com](mailto:info_kr@u-blox.com)  
Support: [support\\_kr@u-blox.com](mailto:support_kr@u-blox.com)

#### Regional Office Taiwan:

Phone: +886 2 2657 1090  
E-mail: [info\\_tw@u-blox.com](mailto:info_tw@u-blox.com)  
Support: [support\\_tw@u-blox.com](mailto:support_tw@u-blox.com)

## X-ON Electronics

Largest Supplier of Electrical and Electronic Components

*Click to view similar products for [RF Modules](#) category:*

*Click to view products by [U-Blox](#) manufacturer:*

Other Similar products are found below :

[HMC-C009](#) [nRF24L01P-MODULE-PCB](#) [HMC-C001](#) [HMC-C021](#) [HMC-C024](#) [XB9XT-DPRS-721](#) [XBP24BZ7PIT-004J](#) [XBP9B-DMUTB022](#) [nRF24L01P-MODULE-SMA](#) [CMD-KEY2-418-CRE](#) [XM-C92-2P-UA](#) [XB9XT-DPUS-721](#) [V640-A90](#) [HMC-C583](#) [MAAM-008818-TR3000](#) [MTSMC-H5-U](#) [SIMSA868-PRO](#) [SIMSA915C-PRO](#) [SIMSA868C-PRO](#) [SIMSA433C-PRO](#) [SIMSA915-PRO](#) [XBP9B-DMUT-042](#) [HMC-C582](#) [HMC-C022](#) [XBP9B-DPST-041](#) [XBP9B-DMWT-042](#) [SM-MN-00-HF-RC](#) [HMC-C031](#) [MT-02](#) [M1002GB](#) [702-W](#) [SIMSA868C-N-PRO](#) [SIMSA433C-N-PRO](#) [SIMSA915C-N-PRO](#) [PEPPER WIRELESS C1 USB](#) [S2-1050J-Z0K4J](#) [S2-10732-Z1T61](#) [S2-10716-Z1W4E](#) [S2-107ET-Z1W6D](#) [S2-10686-Z1L1D](#) [S2-10688-Z1L1T](#) [S2-106BA-Z1P20](#) [UC15EA-MINIPCIE](#) [SU60-2230C-PU](#) [RC-TFSK3-868](#) [NANO RFID POE](#) [650201424G](#) [H330 A30-00](#) [CMD-HHCP-433-MD](#) [RC-CC1101-SPI-868](#)