



SEMIPONT® 4

Power Bridge Rectifiers

SKD 110

Features

- Robust plastic case with screw terminals
- Large, isolated base plate
- Blocking voltage up to 1800 V
- High surge currents
- Three phase bridge rectifier
- Easy chassis mounting
- UL recognized, file no. E 63 532

Typical Applications*

- Three phase rectifiers for power supplies
- Input rectifiers for variable frequency drives
- Rectifiers for DC motor field supplies
- Battery charger rectifiers

1) Available in limited quantities

2) Mounted on a painted metal sheet of min. 250 x 250 x 1 mm;

$R_{th(c-a)} = 1,8 \text{ K/W}$

V_{RSM} V	V_{RRM}, V_{DRM} V	$I_D = 110 \text{ A}$ (full conduction) ($T_c = 100 \text{ °C}$)
800	800	SKD 110/08
1200	1200	SKD 110/12
1400	1400	SKD 110/14
1600	1600	SKD 110/16
1800	1800	SKD 110/18 ¹⁾

Symbol	Conditions	Values	Units
I_D	$T_c = 85 \text{ °C}$	151	A
	$T_a = 45 \text{ °C}$; chassis ²⁾	28	A
	$T_a = 45 \text{ °C}$; P1/200	70	A
	$T_a = 35 \text{ °C}$; P1/120 F	110	A
	$T_a = 35 \text{ °C}$; P3/120 F	123	A
I_{FSM}	$T_{vj} = 25 \text{ °C}$; 10 ms	1200	A
	$T_{vj} = 150 \text{ °C}$; 10 ms	1000	A
i^2t	$T_{vj} = 25 \text{ °C}$; 8,3 ... 10 ms	7200	A ² s
	$T_{vj} = 150 \text{ °C}$; 8,3 ... 10 ms	5000	A ² s
V_F	$T_{vj} = 25 \text{ °C}$; $I_F = 300 \text{ A}$	max. 1,9	V
$V_{(TO)}$	$T_{vj} = 150 \text{ °C}$	max. 0,85	V
r_T	$T_{vj} = 150 \text{ °C}$	max. 4	mΩ
I_{RD}	$T_{vj} = 25 \text{ °C}$; $V_{DD} = V_{DRM}$; $V_{RD} = V_{RRM}$	max. 0,5	mA
	$T_{vj} = 150 \text{ °C}$; $V_{RD} = V_{RRM}$	5	mA
$R_{th(j-c)}$	per diode	0,9	K/W
	total	0,15	K/W
$R_{th(c-s)}$	per diode	0,03	K/W
	total	0,03	K/W
T_{vj}		- 40 ... + 150	°C
T_{stg}		- 40 ... + 125	°C
V_{isol}	a. c. 50 Hz; r.m.s.; 1 s / 1 min.	3600 (3000)	V
M_s	to heatsink	$5 \pm 15 \%$	Nm
M_t	to terminals	$5 \pm 15 \%$	Nm
m		270	g
Case		G 37	

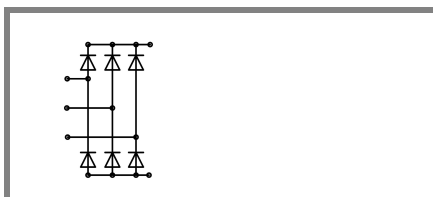

SKD

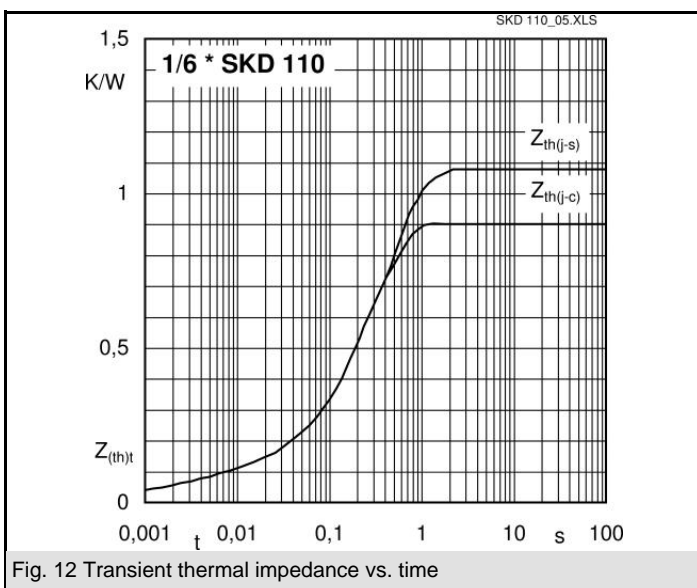
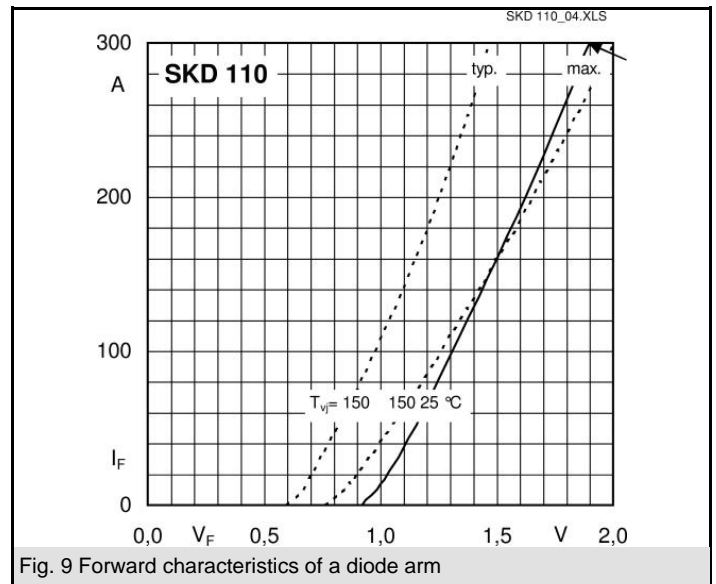
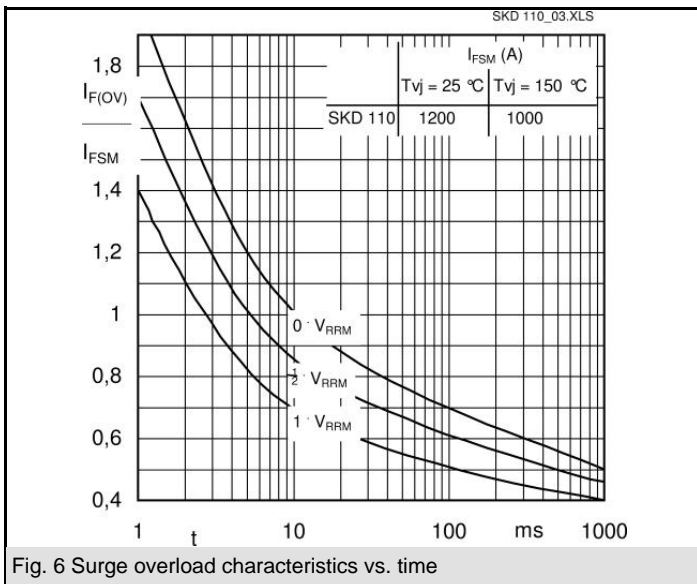
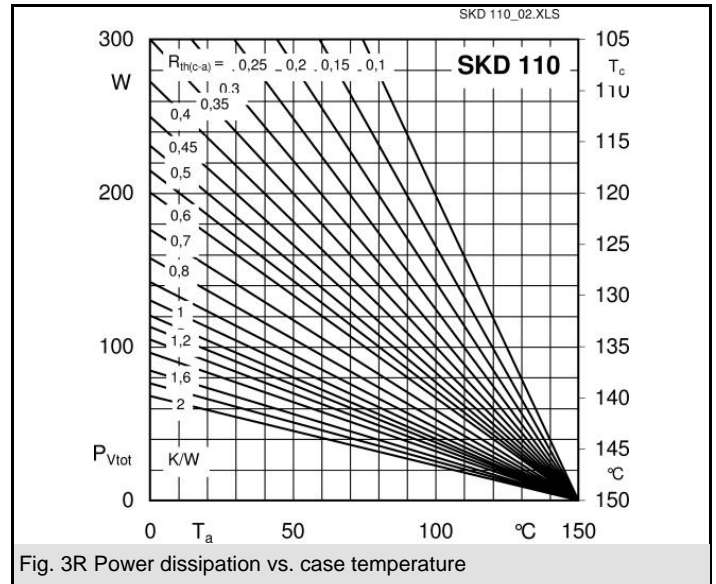
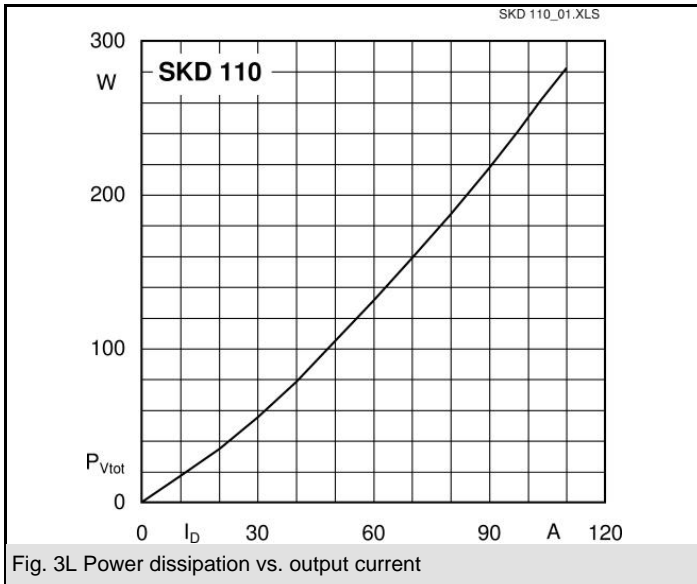

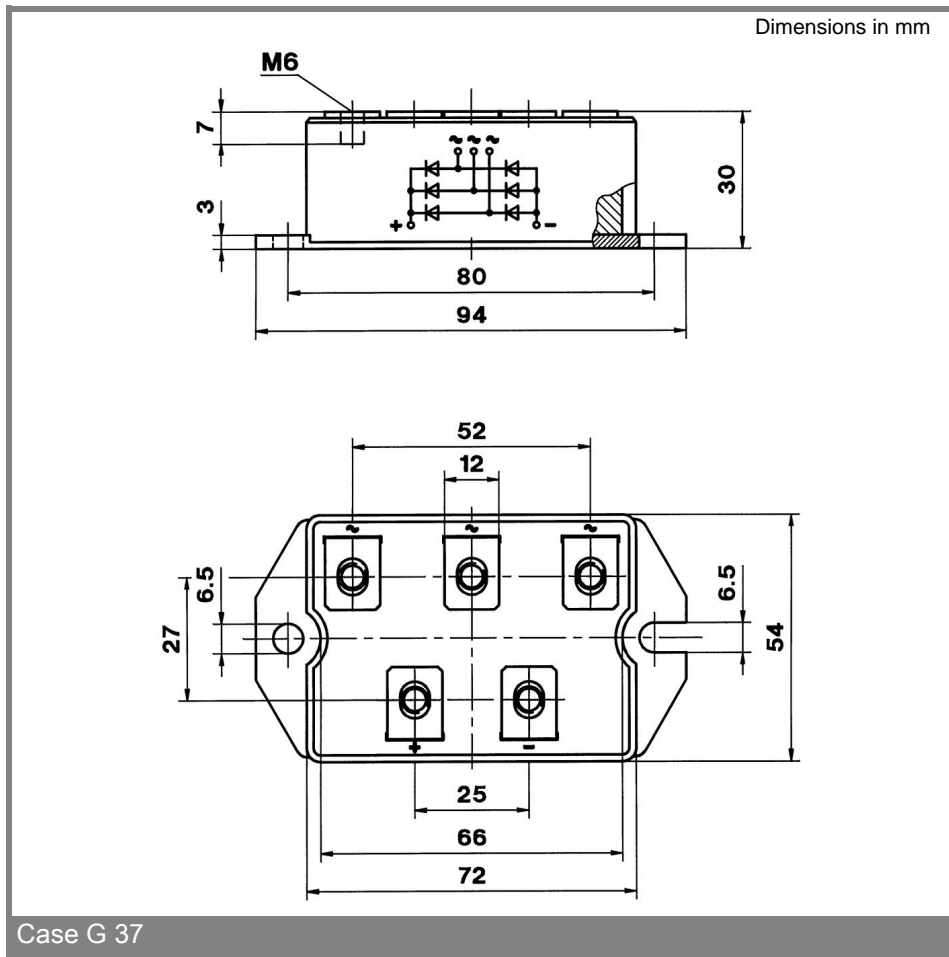

Case G 37

* The specifications of our components may not be considered as an assurance of component characteristics. Components have to be tested for the respective application. Adjustments may be necessary. The use of SEMIKRON products in life support appliances and systems is subject to prior specification and written approval by SEMIKRON. We therefore strongly recommend prior consultation of our personal.

X-ON Electronics

Largest Supplier of Electrical and Electronic Components

Click to view similar products for [Bridge Rectifiers](#) category:

Click to view products by [Semikron](#) manufacturer:

Other Similar products are found below :

[G3SBA60-E351](#) [GBJ1504-BP](#) [GBU10B-BP](#) [GBU15J-BP](#) [GBU15K-BP](#) [GBU4A-BP](#) [GBU4D-BP](#) [GBU6B-E3/45](#) [GSIB680-E3/45](#) [DB101-BP](#) [DF10SA-E345](#) [RMB2S](#) [RCG](#) [APT30DF100HJ](#) [APT60DF20HJ](#) [B2S-E3/80](#) [BU1506-E351](#) [BU15085S-E345](#) [BU1508-E3/45](#) [BU1510-E3/45](#) [RS404GL-BP](#) [RS405GL-BP](#) [G3SBA20-E3/51](#) [G5SBA20-E3/51](#) [G5SBA60-E3/51](#) [GBJ1502-BP](#) [GBL02-E351](#) [GBL10-E3/45](#) [GBU10J-BP](#) [GBU4J-BP](#) [GBU4K-BP](#) [GBU8B-E3/45](#) [GBU8D-BP](#) [GBU8J-BP](#) [GSIB1520-E3/45](#) [MB1510](#) [MB352W](#) [MB6M-G](#) [B2M-E345](#) [B40C7000A](#) [B500C7000A](#) [MP5010W-BP](#) [MP501W-BP](#) [MP502-BP](#) [BR1005-BP](#) [BR101-BP](#) [BU1006-E345](#) [BU12065S-E3/45](#) [BU1508-E3/51](#) [BU2006-E3/45](#) [BU2008-E345](#)