

SKKD 115F

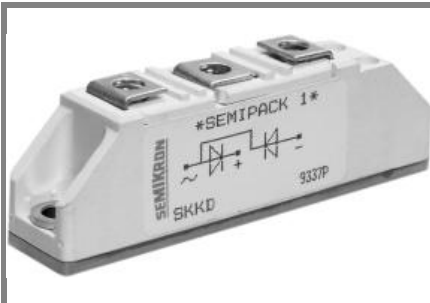

SEMIPACK[®] 1

Fast Diode Modules

SKKD 115F

Features

- Heat transfer through ceramic isolated metal baseplate
- Hard soldered joints for high reliability
- UL recognized, file no. E 63 532

Typical Applications*

- Self-commutated inverters
- DC choppers
- AC motor speed control
- Inductive heating
- Uninterruptible power supplies
- Electronic welders
- General power switching applications

V_{RSM} V	V_{RRM} V	$I_{FRMS} = 200$ A (maximum value for continuous operation) $I_{FAV} = 115$ A (sin. 180; $T_c = 83$ °C)	
1200	1200	SKKD 115F12	
1400	1400	SKKD 115F14	

Symbol	Conditions	Values	Units
I_{FAV}	sin. 180; $T_c = 85$ (100) °C	113 (83)	A
I_{FSM}	$T_{vj} = 25$ °C; 10 ms	2500	A
	$T_{vj} = 130$ °C; 10 ms	2100	A
i^2t	$T_{vj} = 25$ °C; 8,3 ... 10 ms	31250	A ² s
	$T_{vj} = 130$ °C; 8,3 ... 10 ms	22000	A ² s
V_F	$T_{vj} = 25$ °C; $I_F = 300$ A	max. 1,8	V
$V_{(TO)}$	$T_{vj} = 130$ °C	max. 1,1	V
r_T	$T_{vj} = 130$ °C	max. 2	mΩ
I_{RD}	$T_{vj} = 25$ °C; $V_{RD} = V_{RRM}$	max. 1	mA
I_{RD}	$T_{vj} = 130$ °C; $V_{RD} = V_{RRM}$	max. 30	mA
Q_{rr}	$T_{vj} = 130$ °C, $I_F = 100$ A,	90	μC
I_{RM}	$-di/dt = 50$ A/μs, $V_R = 30$ V	90	A
t_{rr}		2000	ns
E_{rr}		1,35	mJ
$R_{th(j-c)}$	per diode / per module	0,24 / 0,12	K/W
$R_{th(c-s)}$	per diode / per module	0,2 / 0,1	K/W
T_{vj}		- 40 ... + 130	°C
T_{stg}		- 40 ... + 125	°C
V_{isol}	a. c. 50 Hz; r.m.s.; 1 s / 1 min.	3600 / 3000	V~
M_s	to heatsink	5 ± 15 %	Nm
M_t	to terminals	3 ± 15 %	Nm
a		5 * 9,81	m/s ²
m	approx.	120	g
Case		A 10	

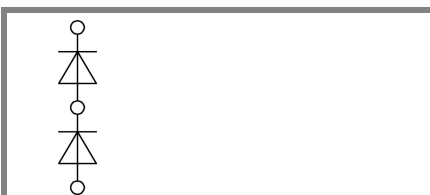

SKKD

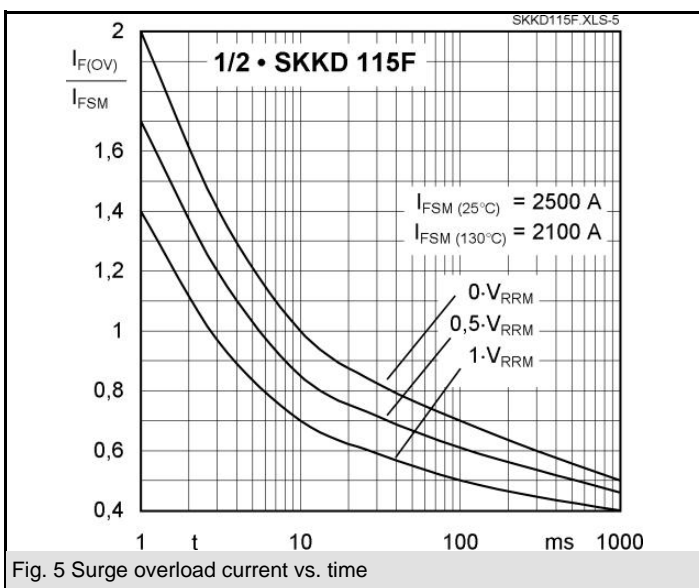
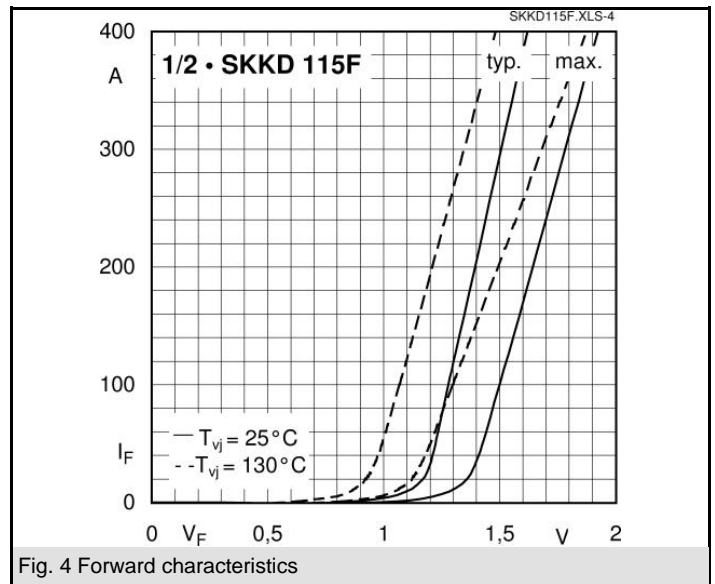
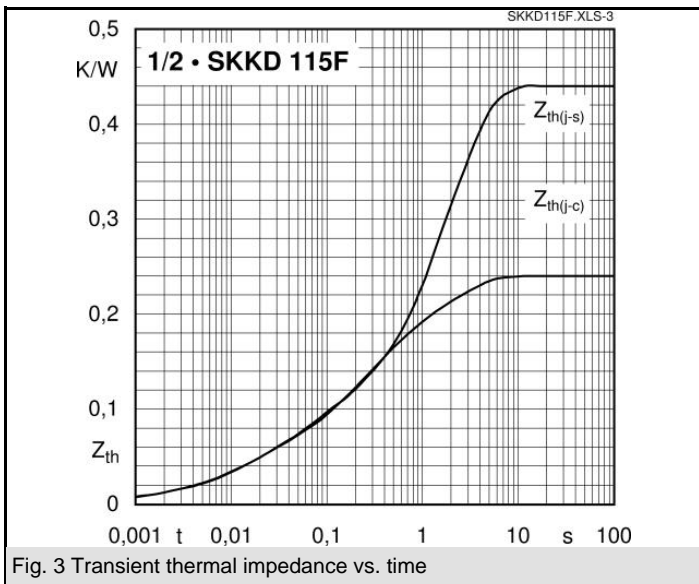
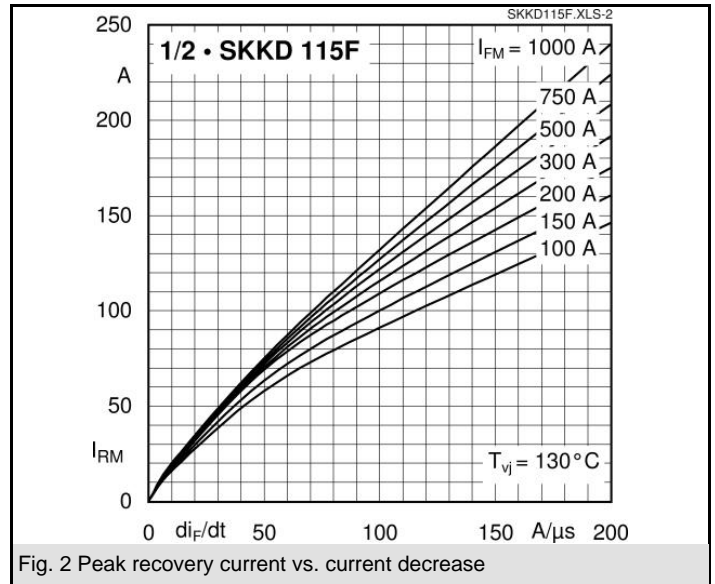
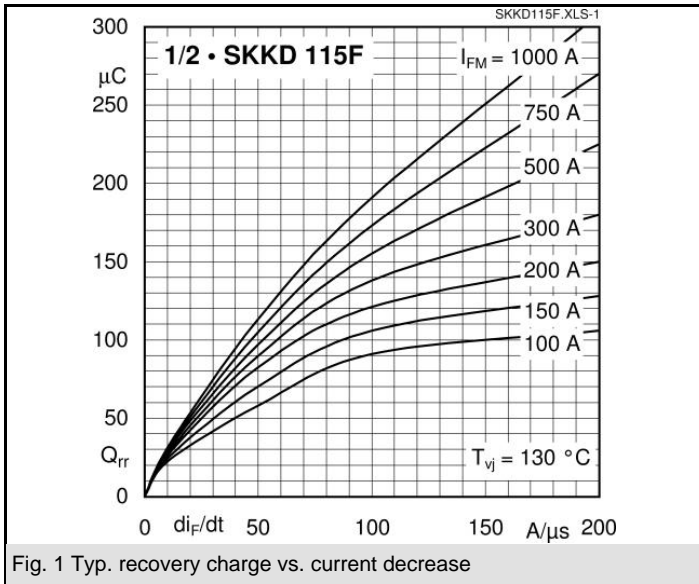

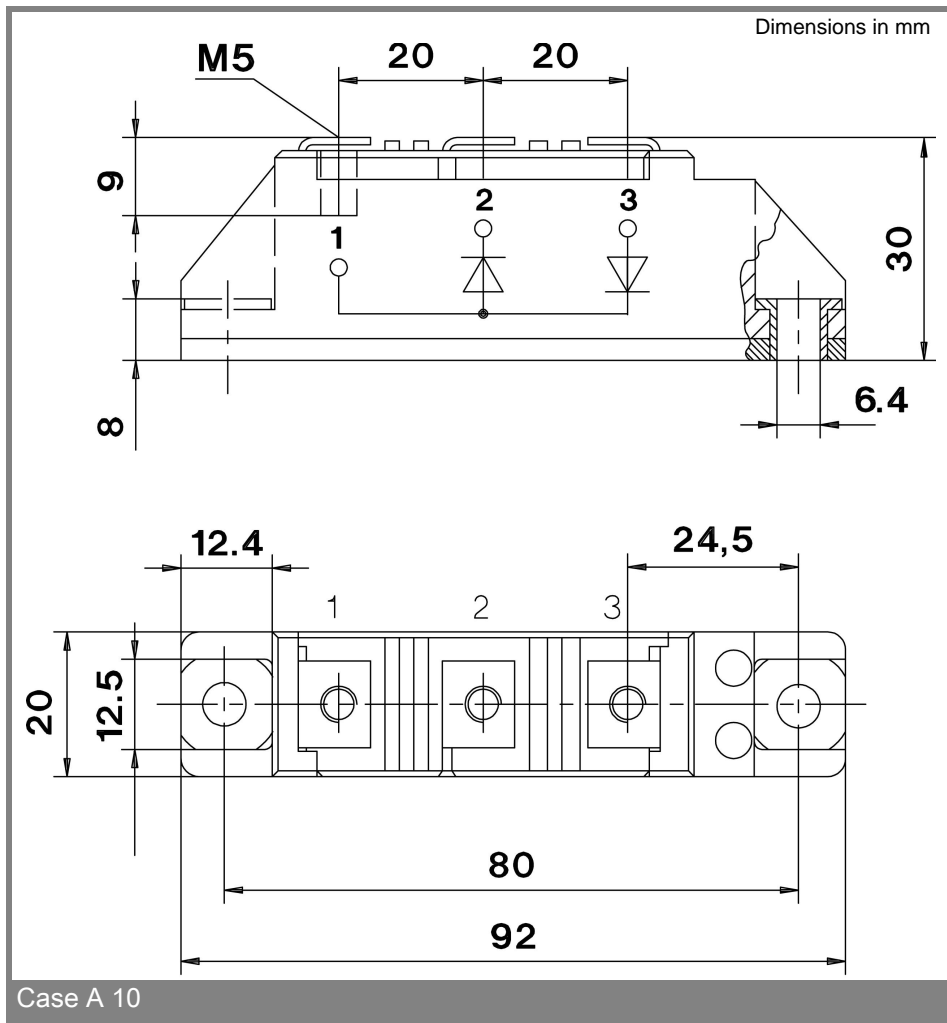

* The specifications of our components may not be considered as an assurance of component characteristics. Components have to be tested for the respective application. Adjustments may be necessary. The use of SEMIKRON products in life support appliances and systems is subject to prior specification and written approval by SEMIKRON. We therefore strongly recommend prior consultation of our personal.

X-ON Electronics

Authorized Distributor

Click to view similar products for [Schottky Diodes & Rectifiers](#) category:

[DD175N32K](#) [DD261N22K](#) [HSMS2815BLKG](#) [C3D20065D](#) [1N8026GA](#) [APT30SCD120S](#)
[MBRT200100](#) [IDH10G65C5](#) [DSSK800008D](#) [50822750](#)