



Stud Thyristor

Line Thyristor

SKT 50

Features

- Hermetic metal case with glass insulator
- Threaded stud ISO M8 or UNF 1/4-28
- International standard case

Typical Applications*

- DC motor control (e. g. for machine tools)
- Controlled rectifiers (e. g. for battery charging)
- AC controllers (e. g. for temperature control)
- Recommended snubber network e. g. for $V_{VRMS} \leq 400$ V:
 $R = 68 \Omega / 11$ W, $C = 0,22 \mu F$

1) Available with UNF thread 1/4-28 UNF2A, e. g. SKT 50/06D UNF

V_{RSM} V	V_{RRM}, V_{DRM} V	$I_{TRMS} = 78$ A (maximum value for continuous operation) $I_{TAV} = 50$ A (sin. 180; $T_c = 78$ °C)	
700	600	SKT 50/06D ¹⁾	
900	800	SKT 50/08D	
1300	1200	SKT 50/12E ¹⁾	
1500	1400	SKT 50/14E ¹⁾	
1700	1600	SKT 50/16E ¹⁾	
1900	1800	SKT 50/18E	

Symbol	Conditions	Values	Units
I_{TAV}	sin. 180; $T_c = 100$ (85) °C;	33 (45)	A
I_D	K5; $T_a = 45$ °C; B2 / B6	25 / 36	A
	K3; $T_a = 45$ °C; B2 / B6	36 / 50	A
I_{RMS}	K3; $T_a = 45$ °C; W1C	40	A
I_{TSM}	$T_{vj} = 25$ °C; 10 ms	1050	A
	$T_{vj} = 130$ °C; 10 ms	900	A
i^2t	$T_{vj} = 25$ °C; 8,35 ... 10 ms	5000	A ² s
	$T_{vj} = 130$ °C; 8,35 ... 10 ms	4000	A ² s
V_T	$T_{vj} = 25$ °C; $I_T = 120$ A	max. 1,8	V
$V_{T(TO)}$	$T_{vj} = 130$ °C	max. 1,1	V
r_T	$T_{vj} = 130$ °C	max. 5	mΩ
I_{DD}, I_{RD}	$T_{vj} = 130$ °C; $V_{RD} = V_{RRM}, V_{DD} = V_{DRM}$	max. 8	mA
t_{gd}	$T_{vj} = 25$ °C; $I_G = 1$ A; $di_G/dt = 1$ A/μs	1	μs
t_{gr}	$V_D = 0,67 * V_{DRM}$	1,5	μs
$(di/dt)_{cr}$	$T_{vj} = 130$ °C	max. 50	A/μs
$(dv/dt)_{cr}$	$T_{vj} = 130$ °C; SKT ...D / SKT ...E	max. 500 / 1000	V/μs
t_q	$T_{vj} = 130$ °C,	100	μs
I_H	$T_{vj} = 25$ °C; typ. / max.	100 / 200	mA
I_L	$T_{vj} = 25$ °C; $R_G = 33 \Omega$; typ. / max.	250 / 400	mA
V_{GT}	$T_{vj} = 25$ °C; d.c.	min. 3	V
I_{GT}	$T_{vj} = 25$ °C; d.c.	min. 150	mA
V_{GD}	$T_{vj} = 130$ °C; d.c.	max. 0,25	V
I_{GD}	$T_{vj} = 130$ °C; d.c.	max. 5	mA
$R_{th(j-c)}$	cont.	0,57	K/W
$R_{th(j-c)}$	sin. 180	0,6	K/W
$R_{th(j-c)}$	rec. 120	0,65	K/W
$R_{th(c-s)}$		0,2	K/W
T_{vj}		- 40 ... + 130	°C
T_{stg}		- 55 ... + 150	°C
V_{isol}		-	V~
M_s	to heatsink	4 (UNF: 2,5)	Nm
a		5 * 9,81	m/s ²
m	approx.	22	g
Case		B 3	



SKT

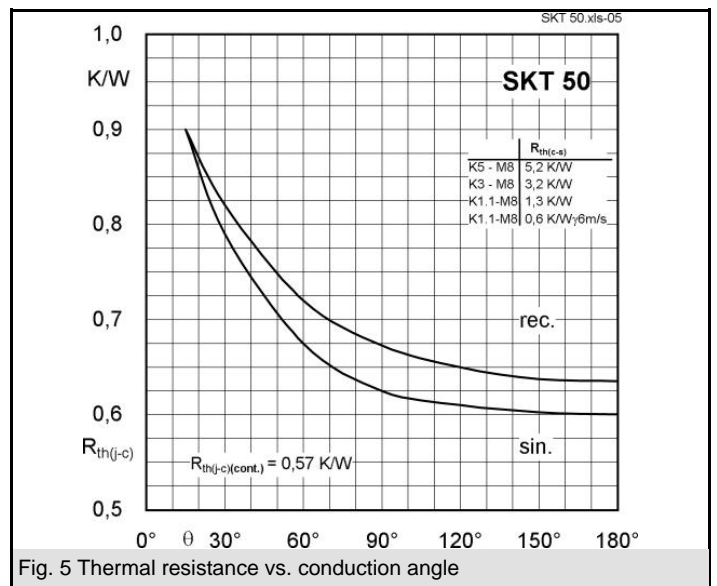
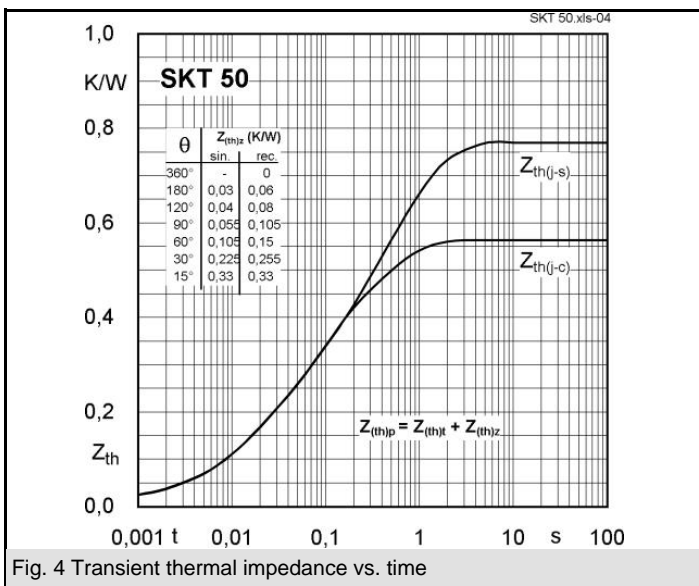
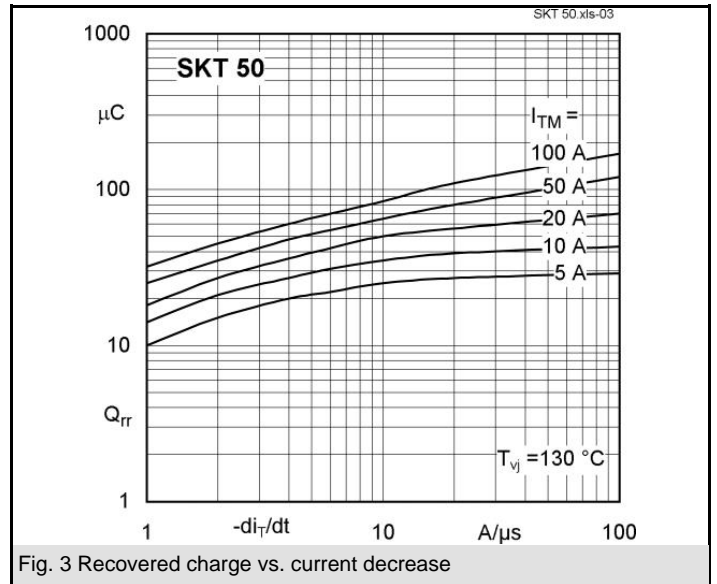
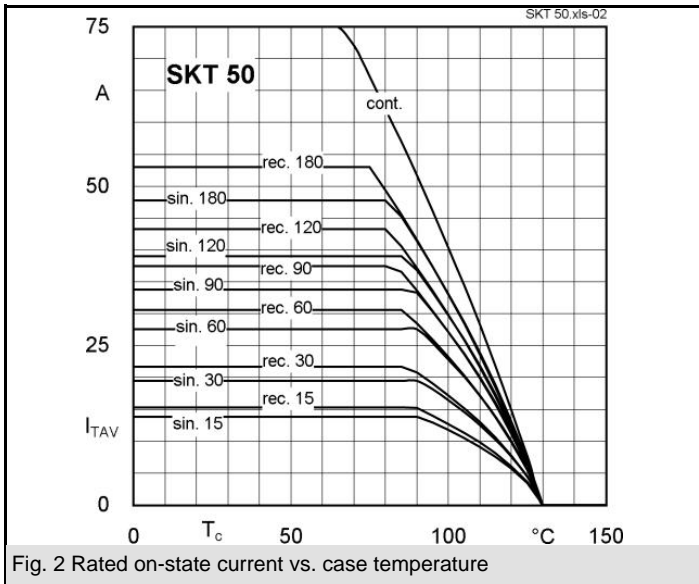
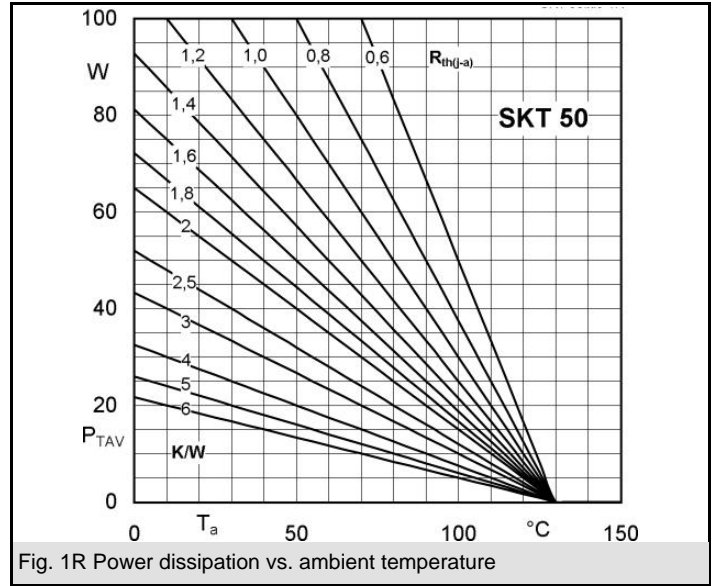
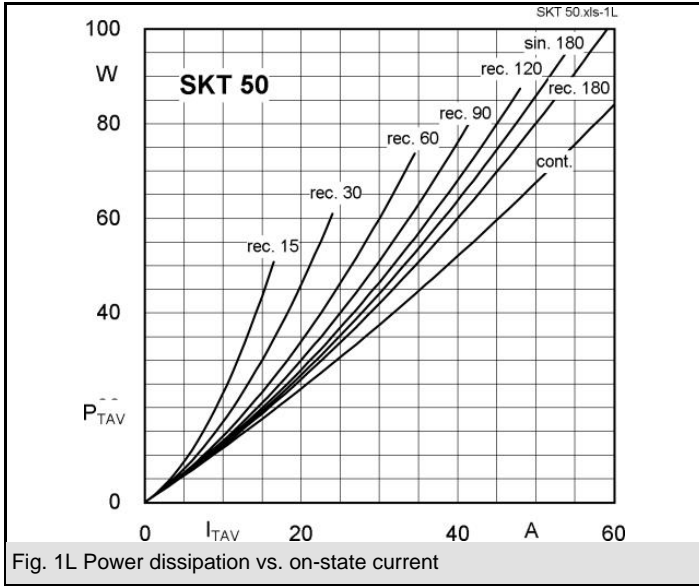

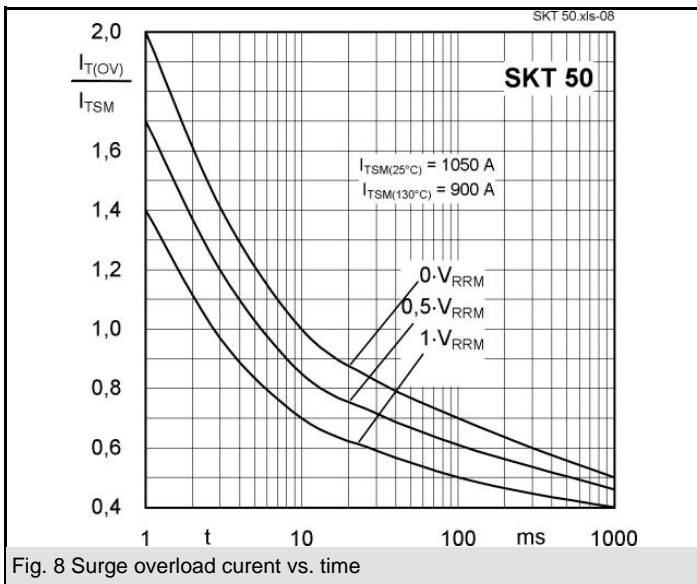
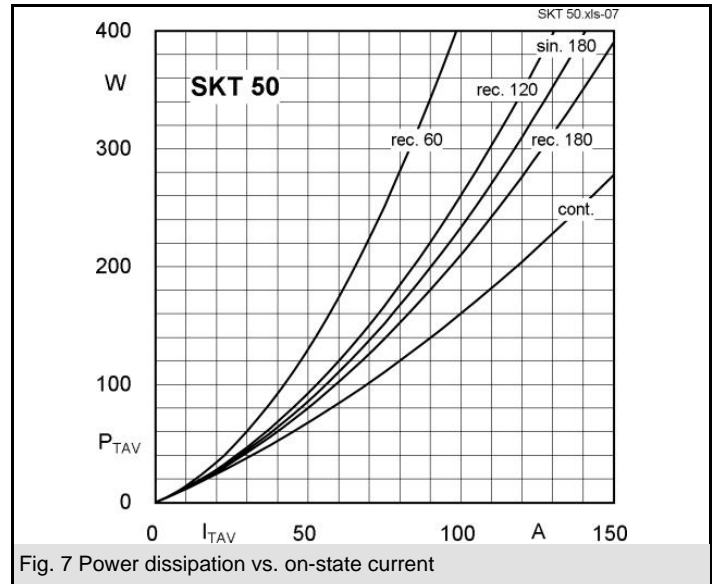
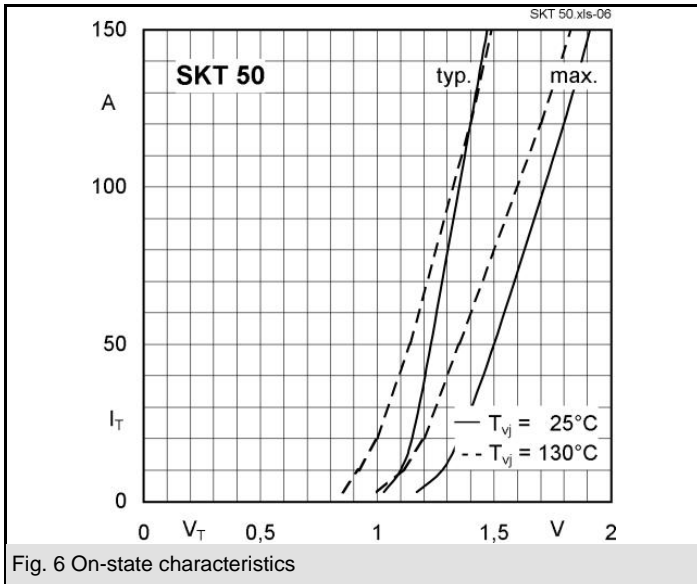

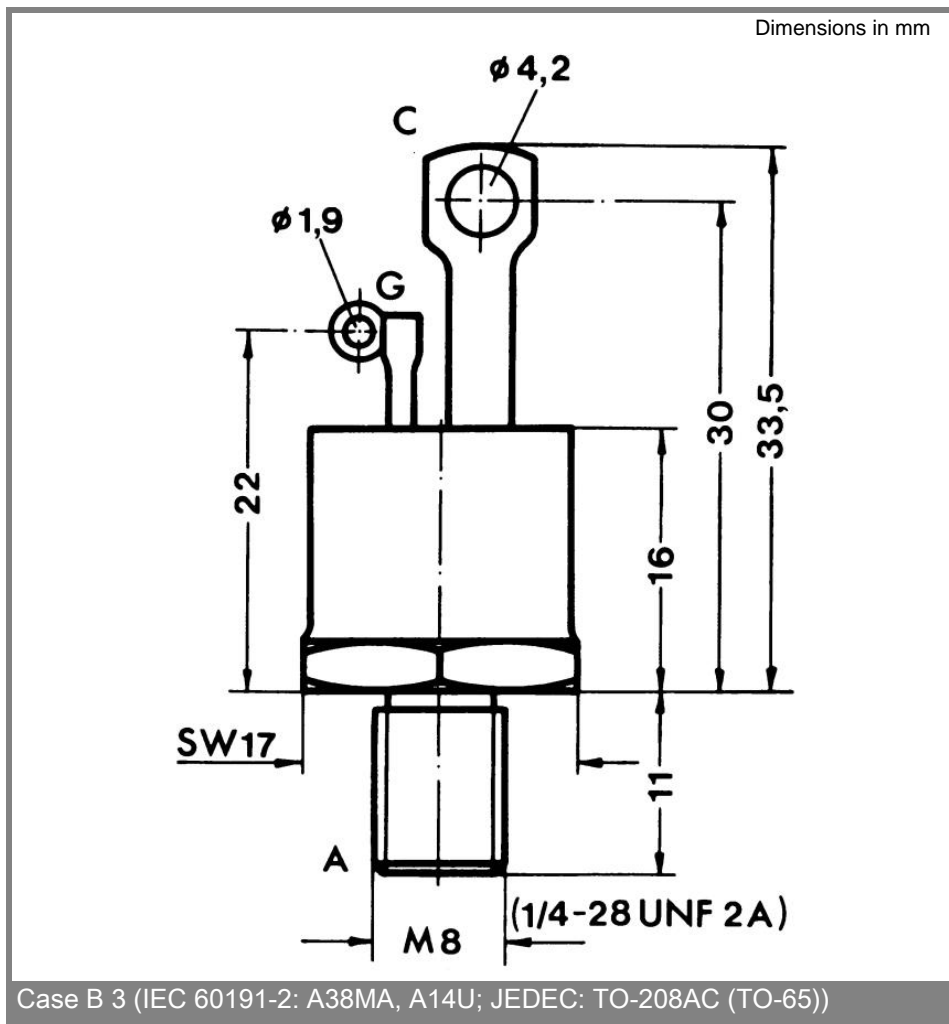
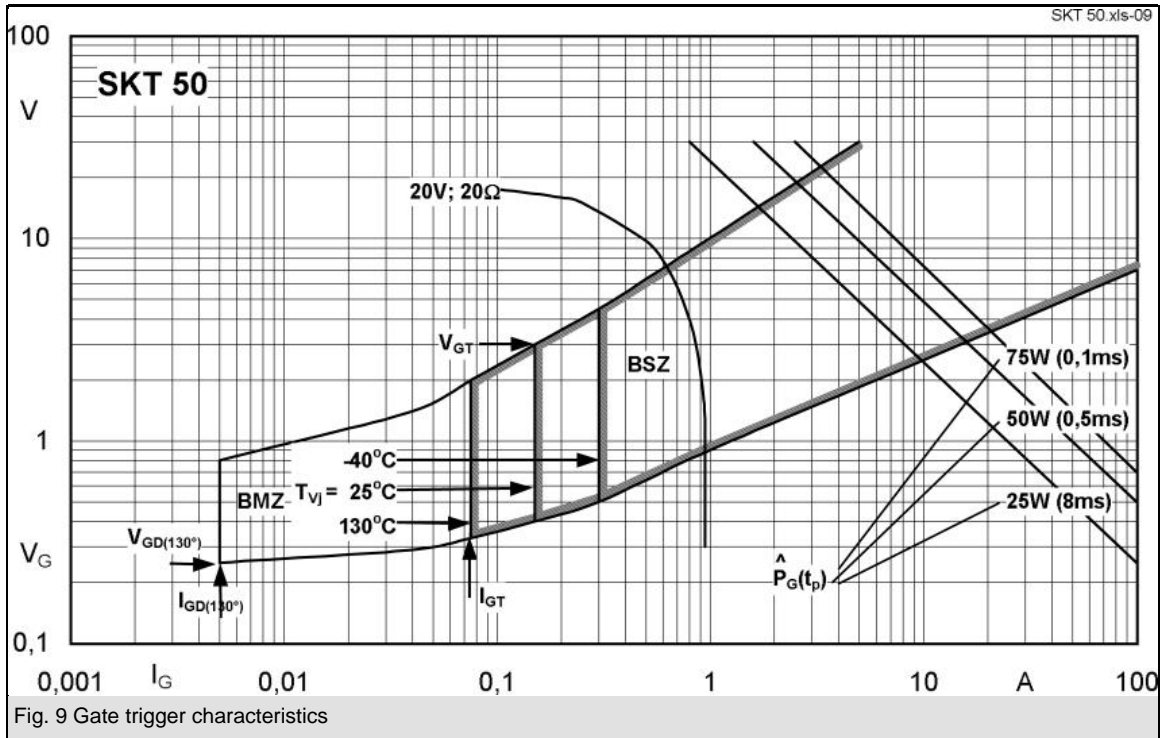

* The specifications of our components may not be considered as an assurance of component characteristics. Components have to be tested for the respective application. Adjustments may be necessary. The use of SEMIKRON

products in life support appliances and systems is subject to prior specification and written approval by SEMIKRON. We therefore strongly recommend prior consultation of our personal.

X-ON Electronics

Largest Supplier of Electrical and Electronic Components

Click to view similar products for [SCRs category](#):

Click to view products by [Semikron manufacturer](#):

Other Similar products are found below :

[NTE5428](#) [NTE5448](#) [NTE5457](#) [NTE5511](#) [T1500N16TOF VT](#) [T720N18TOF](#) [T880N14TOF](#) [T880N16TOF](#) [TN1205H-6G](#) [TN1215-800B-TR](#)
[TS110-7UF](#) [TT104N12KOF-A](#) [TT104N12KOF-K](#) [TT162N16KOF-A](#) [TT162N16KOF-K](#) [TT330N16AOF](#) [VS-111RKI120PBF](#) [VS-16RIA100](#)
[VS-22RIA20](#) [VS-2N5206](#) [VS-2N685](#) [VS-40TPS08A-M3](#) [VS-50RIA10](#) [057219R](#) [T1190N16TOF VT](#) [T1220N22TOF VT](#) [T201N70TOH](#)
[T830N14TOF](#) [T830N18TOF](#) [TD92N16KOF-A](#) [TT250N12KOF-K](#) [VS-ST180S12P0V](#) [VS-25RIA40](#) [VS-16RIA120](#) [VS-30TPS08PBF](#)
[TN1215-800G-TR](#) [NTE5427](#) [NTE5442](#) [X0405NF 1AA2](#) [VS-ST300S20P0PBF](#) [T2160N28TOF VT](#) [TT251N16KOF-K](#) [VS-22RIA100](#) [VS-](#)
[16RIA40](#) [CR02AM-8#F00](#) [VS-ST110S12P0VPBF](#) [TD250N16KOF-A](#) [GA301A](#) [VS-ST110S16P0](#) [VS-10RIA10](#)