

# Printed-circuit board connector - DFMC 1,5/18-ST-3,5 - 1790263

Please be informed that the data shown in this PDF Document is generated from our Online Catalog. Please find the complete data in the user's documentation. Our General Terms of Use for Downloads are valid (<http://phoenixcontact.com/download>)

Plug, nominal current: 8 A, rated voltage (III/2): 160 V, number of positions: 18 with 36 contacts, pitch: 3.5 mm, connection method: spring-cage connection, color: green, contact surface: tin

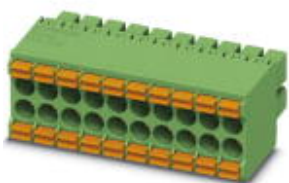

The figure shows a 10-pos. version with 20 contacts

## Why buy this product

- Time saving push-in connection, tools not required
- Defined contact force ensures that contact remains stable over the long term
- Intuitive use through colour coded actuation lever
- Optimized for tight installation situations: operation and conductor connection from one direction

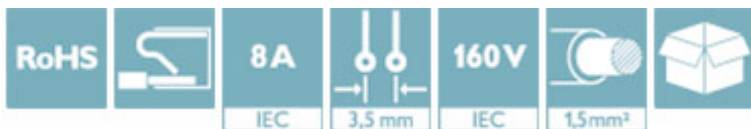

## Key Commercial Data

Packing unit	50 STK
GTIN	 4 046356 594516
GTIN	4046356594516
Weight per Piece (excluding packing)	18.570 g
Custom tariff number	85366990
Country of origin	Germany
Note	Made to Order (non-returnable)

## Technical data

### Dimensions

Length	22.65 mm
Height	13.25 mm
Width	63.8 mm
Pitch	3.5 mm
Dimension a	59.5 mm

### General

Range of articles	DFMC 1,5/...-ST
-------------------	-----------------

# Printed-circuit board connector - DFMC 1,5/18-ST-3,5 - 1790263

## Technical data

### General

Type of contact	Female connector
Number of positions	18
Connection method	Push-in spring connection
Insulating material group	I
Rated surge voltage (III/3)	2.5 kV
Rated surge voltage (III/2)	2.5 kV
Rated surge voltage (II/2)	2.5 kV
Rated voltage (III/3)	160 V
Rated voltage (III/2)	160 V
Rated voltage (II/2)	250 V
Connection in acc. with standard	EN-VDE
Nominal current I <sub>N</sub>	8 A
Nominal cross section	1.5 mm <sup>2</sup>
Maximum load current	8 A
Insulating material	PA
Flammability rating according to UL 94	V0
Internal cylindrical gage	A1
Stripping length	10 mm

### Connection data

Conductor cross section solid min.	0.2 mm <sup>2</sup>
Conductor cross section solid max.	1.5 mm <sup>2</sup>
Conductor cross section flexible min.	0.2 mm <sup>2</sup>
Conductor cross section flexible max.	1.5 mm <sup>2</sup>
Conductor cross section flexible, with ferrule without plastic sleeve min.	0.25 mm <sup>2</sup>
Conductor cross section flexible, with ferrule without plastic sleeve max.	1.5 mm <sup>2</sup>
Conductor cross section flexible, with ferrule with plastic sleeve min.	0.25 mm <sup>2</sup>
Conductor cross section flexible, with ferrule with plastic sleeve max.	0.75 mm <sup>2</sup>
Conductor cross section AWG min.	24
Conductor cross section AWG max.	16
Minimum AWG according to UL/CUL	16
Maximum AWG according to UL/CUL	24

### Standards and Regulations

Connection in acc. with standard	EN-VDE
	CUL
Flammability rating according to UL 94	V0

### Environmental Product Compliance

China RoHS	Environmentally friendly use period: unlimited = EFUP-e
	No hazardous substances above threshold values

# Printed-circuit board connector - DFMC 1,5/18-ST-3,5 - 1790263

## Drawings

Diagram

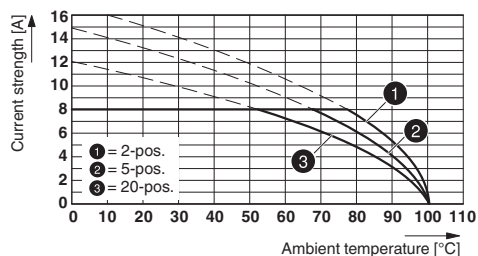

Schematic diagram

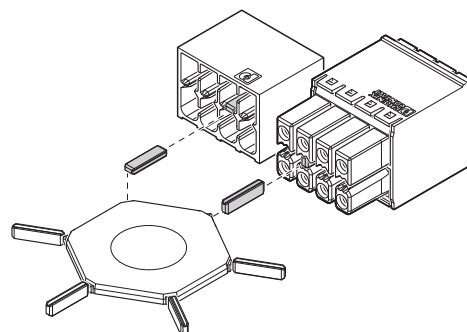

Typ: DFMC 1,5/...-ST-3,5 with DMCV 1,5/...-G1-3,5 P20 THR

Use of the CP-DMC... coding profile

Diagram

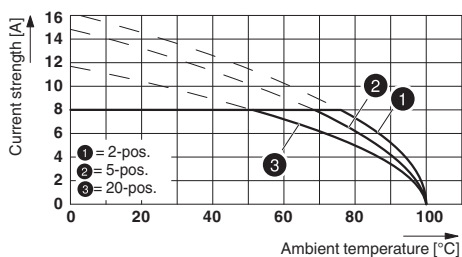

Dimensional drawing

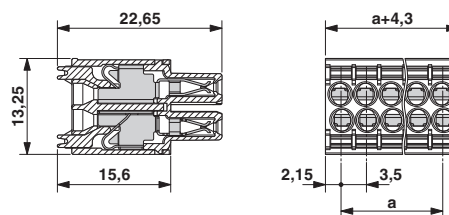

Typ: DFMC 1,5/...-ST-3,5 with DMC 1,5/...-G1-3,5 P20 THR

## Classifications

eCl@ss

eCl@ss 4.0	272607xx
eCl@ss 4.1	27260701
eCl@ss 5.0	27260701
eCl@ss 5.1	27141190
eCl@ss 6.0	27260704
eCl@ss 7.0	27440402
eCl@ss 8.0	27440309
eCl@ss 9.0	27440309

ETIM

ETIM 4.0	EC002638
ETIM 5.0	EC002638
ETIM 6.0	EC002638

UNSPSC

UNSPSC 6.01	30211810
-------------	----------

# Printed-circuit board connector - DFMC 1,5/18-ST-3,5 - 1790263

## Classifications

### UNSPSC

UNSPSC 7.0901	39121409
UNSPSC 11	39121409
UNSPSC 12.01	39121409
UNSPSC 13.2	39121409

## Approvals

### Approvals

#### Approvals

VDE Gutachten mit Fertigungsüberwachung / IECEE CB Scheme / cULus Recognized / EAC

#### Ex Approvals

### Approval details

VDE Gutachten mit Fertigungsüberwachung		<a href="http://www.vde.com/en/Institute/OnlineService/VDE-approved-products/Pages/Online-Search.aspx">http://www.vde.com/en/Institute/OnlineService/VDE-approved-products/Pages/Online-Search.aspx</a>	40038423
mm²/AWG/kcmil	0.2-1.5		
Nominal current I <sub>N</sub>	8 A		
Nominal voltage U <sub>N</sub>	160 V		

IECEE CB Scheme		<a href="http://www.iecee.org/">http://www.iecee.org/</a>	DE1-56070_B1_B2
Nominal current I <sub>N</sub>	8 A		
Nominal voltage U <sub>N</sub>	160 V		

cULus Recognized		<a href="http://database.ul.com/cgi-bin/XYV/template/LISEXT/1FRAME/index.htm">http://database.ul.com/cgi-bin/XYV/template/LISEXT/1FRAME/index.htm</a>	E60425-19920306
	B	C	
mm²/AWG/kcmil	16-24	16-24	
Nominal current I <sub>N</sub>	8 A	8 A	
Nominal voltage U <sub>N</sub>	150 V	50 V	

# Printed-circuit board connector - DFMC 1,5/18-ST-3,5 - 1790263

## Approvals

EAC		B.01742
-----	--	---------

## Accessories

### Accessories

#### Coding element

Coding profile - CP-DMC 1,5 NAT - 1790647



Coding profile, for insertion between the coding ribs of the connector and the header following the reflow soldering process, insulating material, color: natural

## Crimping tool

Crimping pliers - CRIMPFOX 6 - 1212034



Crimping pliers, for ferrules without insulating collar according to DIN 46228 Part 1 and ferrules with insulating collar according to DIN 46228 Part 4, 0.25 mm<sup>2</sup> ... 6.0 mm<sup>2</sup>, lateral entry, trapezoidal crimp

## Screwdriver tools

Screwdriver - SZS 0,4X2,5 VDE - 1205037



Screwdriver, slot-headed, VDE insulated, size: 0.4 x 2.5 x 80 mm, 2-component grip, with non-slip grip

## Additional products

Printed-circuit board connector - DMC 1,5/18-G1-3,5 P20THR - 1786992



Header, Nominal current: 8 A, Rated voltage (III/2): 160 V, Number of positions: 18, Pitch: 3.5 mm, Color: black, Contact surface: Tin, Mounting: THR soldering

## Printed-circuit board connector - DFMC 1,5/18-ST-3,5 - 1790263

### Accessories

Printed-circuit board connector - DMCV 1,5/18-G1-3,5 P20THR - 1787360



Header, Nominal current: 8 A, Rated voltage (III/2): 160 V, Number of positions: 18, Pitch: 3.5 mm, Color: black, Contact surface: Tin, Mounting: THR soldering

---

Phoenix Contact 2016 © - all rights reserved  
<http://www.phoenixcontact.com>

## X-ON Electronics

Largest Supplier of Electrical and Electronic Components

*Click to view similar products for [Phoenix Contact](#) manufacturer:*

Other Similar products are found below :

[1212619](#) [3240366](#) [1893300](#) [1401029](#) [1773093](#) [2814045](#) [2989433](#) [2963886](#) [2966537](#) [2313944](#) [2834546](#) [2834407](#) [1687312](#) [3056145](#)  
[1775619](#) [1618261](#) [1674998](#) [2858894](#) [443023](#) [2905235](#) [2833547](#) [3240098](#) [2905234](#) [FFKDS/V-2.54](#) [0201391](#) [0201595](#) [7001438](#)  
[MICROFOX-R](#) [PLC-RSP- 24DC/21-21](#) [PR1-RSC3-LDP-24DC/21](#) [PR1-RSC3-LV-120AC/2X21](#) [PSI-MOS-DNET CAN/FO 660/BM](#) [PSM-](#)  
[SET-FSMA/4-KT](#) [PSR-SCF-120UC/URM/2X21](#) [PT 4-DIO 1N 5408/L-R](#) [PT 4-FSI/F-LED 12](#) [1202580](#) [1203534](#) [1205985](#) [1206308](#) [1201798](#)  
[1207420](#) [1207886](#) [1208461](#) [1208843](#) [1206188](#) [1212066](#) [1212096](#) [1212171](#) [1212250](#)