

## Thick Film Chip Resistor Array

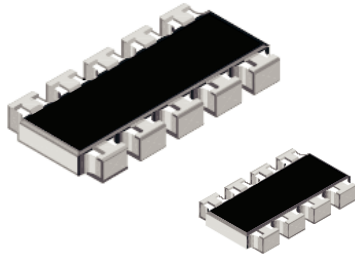

### FEATURES

- Convex terminal array available with either scalloped corners (E version) or square corners (S version)
- Wide ohmic range: 10R to 1M $\Omega$
- 8 or 10 terminal package with isolated resistors
- Pure tin solder contacts on Ni barrier layer, provides compatibility with lead (Pb)-free and lead containing soldering processes
- Material categorization: For definitions of compliance please see [www.vishay.com/doc?99912](http://www.vishay.com/doc?99912)



**RoHS**  
COMPLIANT  
HALOGEN  
**FREE**

STANDARD ELECTRICAL SPECIFICATIONS							
MODEL	CIRCUIT	POWER RATING $P_{70^\circ\text{C}}$ W	LIMITING ELEMENT VOLTAGE MAX. $V_{\text{E}}$	TEMPERATURE COEFFICIENT $\pm$ ppm/K	TOLERANCE $\pm$ %	RESISTANCE RANGE $\Omega$	SERIES
CRA12E CRA12S	01; 02; 20	0.100	50	100	1	10 to 1M	E24; E96
	03	0.125		200	2; 5	10 to 1M	E24
Zero-Ohm-Resistor: $R_{\text{max.}} = 50 \text{ m}\Omega$ , $I_{\text{max.}} = 1.5 \text{ A}$							

TECHNICAL SPECIFICATIONS			
PARAMETER	UNIT	CRA12E AND CRA12S CIRCUIT 01; 02; 20	CRA12E AND CRA12S CIRCUIT 03
Rated dissipation at $P_{70}^{(1)}$	W per element	0.1	0.125
Limiting element voltage $U_{\text{max. AC/DC}}$	V	50	
Insulation voltage $U_{\text{ins}}$ (1 min)	V	100	
Insulation resistance	$\Omega$	$> 10^9$	
Category temperature range	$^\circ\text{C}$	- 55 to + 155	

### Note

<sup>(1)</sup> Power rating depends on the max. temperature at the solder point, the component placement density and the substrate material.

PART NUMBER AND PRODUCT DESCRIPTION																	
Part Number: CRA12E08347K0JTR <sup>(2)</sup>																	
C	R	A	1	2	E	0	8	3	4	7	K	0	J	T	R		
MODEL	TERMINAL STYLE	PIN	CIRCUIT	VALUE	TOLERANCE	PACKAGING	SPECIAL										
CRA12	S E	08 10	1 = 01 2 = 02 3 = 03 8 = 20	R = Decimal K = Thousand M = Million 0000 = 0 $\Omega$ Jumper	F = $\pm 1\%$ G = $\pm 2\%$ J = $\pm 5\%$ Z = 0 $\Omega$ Jumper	TR TL	Up to 2 digits										
Product Description: CRA12E 08 03 47K 5% RB8 e3																	
CRA12E	08	03	47K	5%	RB8	e3											
MODEL	PIN	CIRCUIT	RESISTANCE VALUE	TOLERANCE	PACKAGING	LEAD (Pb)-FREE											
CRA12E CRA12S	08 10	01 02 03 20	10R = 10 $\Omega$ 47K = 47 k $\Omega$ 1M = 1M $\Omega$ 0R0 = Jumper	$\pm 1\%$ $\pm 2\%$ $\pm 5\%$	RB8 RD7	e3 = Pure tin termination finish											

### Note

<sup>(2)</sup> Preferred way for ordering products is by use of the PART NUMBER.

AVAILABLE TYPES AND RANGES				
MODEL	TERMINAL COUNT	CIRCUIT	TEMPERATURE COEFFICIENT	TOLERANCE
CRA12S	10	01	± 100 ppm/K ± 200 ppm/K	± 1 %; ± 2 %; ± 5 %
		02		
		03		
CRA12E	08	01		
	10	02		
		03		
		20		

PACKAGING						
MODEL	TAPE WIDTH	DIAMETER	PITCH	PIECES/REEL	BLISTER TAPE ACC. IEC 60286-3, TYPE II	
					PART NUMBER	PRODUCT DESCRIPTION
CRA12E 08	12 mm	180 mm/7" 330 mm/13"	8 mm	2000 5000	TR	RB8
CRA12E 10					TL	RD7
CRA12S 10						

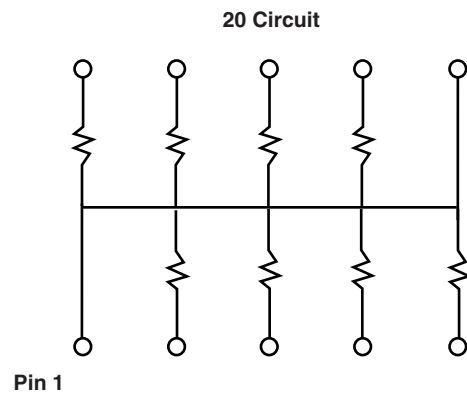
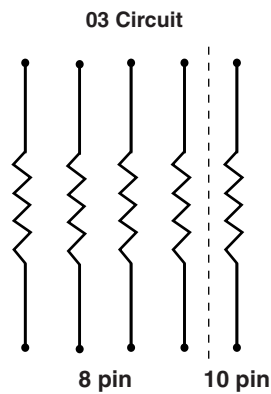
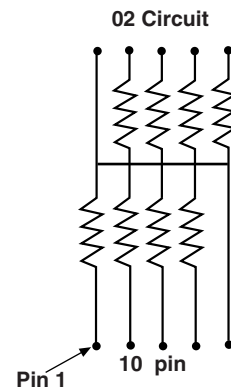
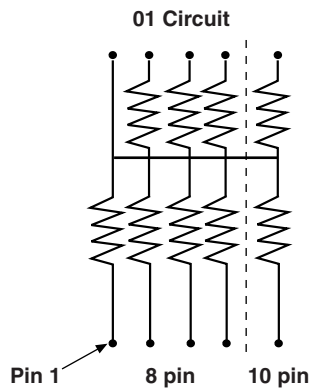
**CIRCUIT**

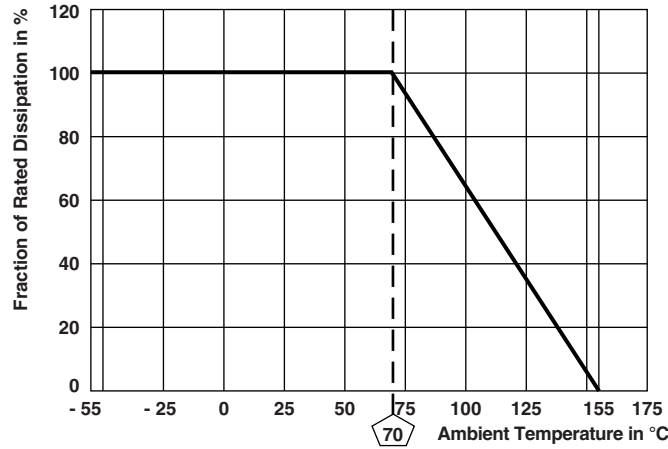
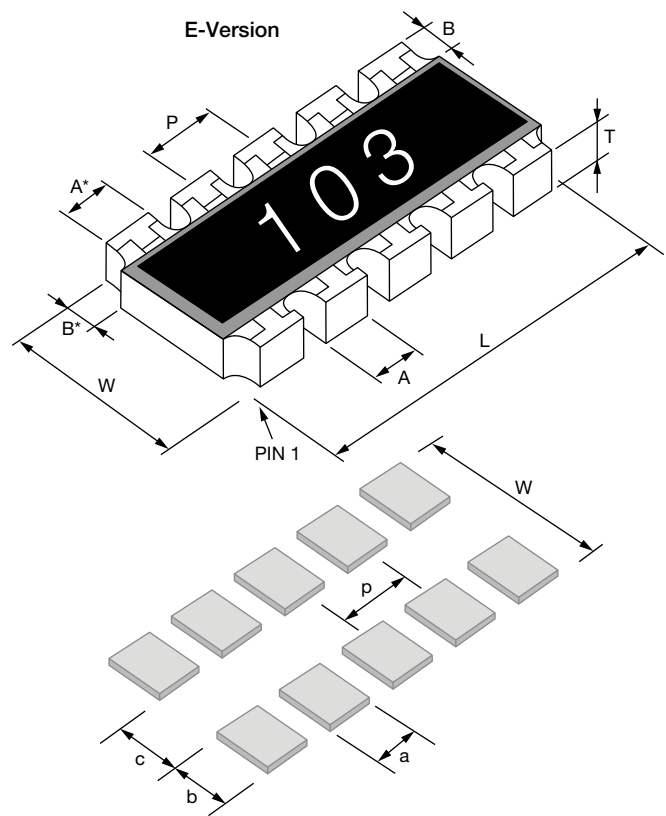
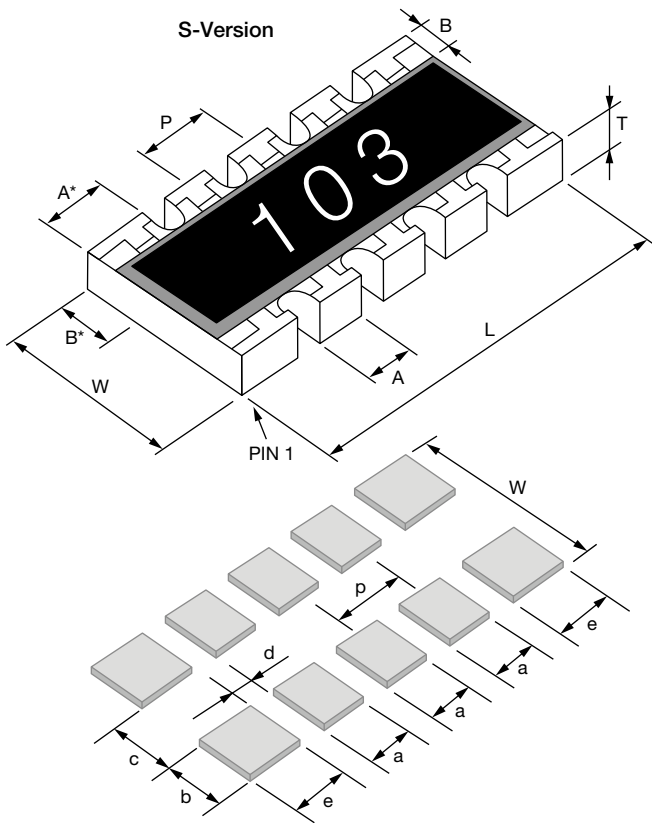
**DERATING**

**DIMENSIONS**

MODEL	PIN NO #	DIMENSIONS in millimeters							
		L	A	A*	B	B*	P	T	W
CRA12E	8	5.08	0.79	-	0.51	0.38	1.27	0.55	3.05
CRA12E	10	6.40	0.79	-	0.51	0.38	1.27	0.55	3.05
CRA12S	10	6.40	0.79	0.89	0.51	0.38	1.27	0.55	3.05
	<b>TOL.</b>	± 0.15	± 0.15	± 0.15	± 0.25	± 0.2	± 0.1	± 0.15	± 0.15

SOLDER PAD DIMENSIONS in millimeters							
	c	w	d	p	a	b	e
<b>WAVE</b>	2.2	4.3	0.57	1.27	0.71	1.05	1.09
<b>REFLOW</b>	2.2	3.9	0.57	1.27	0.71	0.86	1.09



TEST PROCEDURES AND REQUIREMENTS					
EN 60115-1 CLAUSE	IEC 60068-2 TEST METHOD	TEST	PROCEDURE	REQUIREMENTS PERMISSIBLE CHANGE ( $\Delta R$ ) <sup>(1)</sup>	
				STABILITY CLASS 1 OR BETTER	STABILITY CLASS 2 OR BETTER
			Stability for product type: <b>CRA12E/CRA12S</b>	10 $\Omega$ to 1 M $\Omega$	
4.5	-	Resistance	-	$\pm 1 \%$	$\pm 2 \%, \pm 5 \%$
4.7	-	Voltage proof	$U = 1.4 \times U_{ins}$ ; 60 s	No flashover or breakdown	
4.13	-	Short time overload	$U = 2.5 \times \sqrt{P_{70} \times R} \leq 2 \times U_{max.}$ ; Duration according to style	$\pm (0.25 \% R + 0.05 \Omega)$	$\pm (0.5 \% R + 0.05 \Omega)$
4.17.2	58 (Td)	Solderability	Solder bath method; Sn60Pb40; non-activated flux; (235 $\pm$ 5) $^{\circ}$ C; (2 $\pm$ 0.2) s	Good tinning ( $\geq 95 \%$ covered) no visible damage	
			Solder bath method; Sn96.5Ag3Cu0.5; non-activated flux; (245 $\pm$ 5) $^{\circ}$ C; (3 $\pm$ 0.3) s	Good tinning ( $\geq 95 \%$ covered) no visible damage	
4.8.4.2	-	Temperature coefficient	(20/- 55/20) $^{\circ}$ C and (20/125/20) $^{\circ}$ C	$\pm 100$ ppm/K	$\pm 200$ ppm/K
4.32	21 (U <sub>J3</sub> )	Shear (adhesion)	45 N	No visible damage	
4.33	21 (U <sub>U1</sub> )	Substrate bending	Depth 2 mm; 3 times	No visible damage, no open circuit in bent position $\pm (0.25 \% R + 0.05 \Omega)$	
4.19	14 (Na)	Rapid change of temperature	30 min. at - 55 $^{\circ}$ C; 30 min at 125 $^{\circ}$ C 5 cycles 1000 cycles	$\pm (0.25 \% R + 0.05 \Omega)$ $\pm (1 \% R + 0.05 \Omega)$	$\pm (0.5 \% R + 0.05 \Omega)$ $\pm (1 \% R + 0.05 \Omega)$
4.23	-	Dry heat	-	$\pm (1 \% R + 0.05 \Omega)$ $\pm (2 \% R + 0.1 \Omega)$	
4.23.2	2 (Ba)	Damp heat, cyclic	125 $^{\circ}$ C; 16 h		
4.23.3	30 (Db)	Cold	55 $^{\circ}$ C; $\geq 90 \%$ RH; 24 h; 1 cycle		
4.23.4	1 (Aa)	Low air pressure	- 55 $^{\circ}$ C; 2 h		
4.23.5	13 (M)	-	1 kPa; (25 $\pm$ 10) $^{\circ}$ C; 1 h		
4.23.6	30 (Db)	Damp heat, cyclic	55 $^{\circ}$ C; $\geq 90 \%$ RH; 24 h; 5 cycle		
4.23.7	-	DC load	$U = \sqrt{P_{70} \times R}$		
4.25.1	-	Endurance at 70 $^{\circ}$ C	$U = \sqrt{P_{70} \times R} \leq U_{max.}$ 1.5 h on; 0.5 h off; 70 $^{\circ}$ C; 1000 h 70 $^{\circ}$ C; 8000 h	$\pm (1 \% R + 0.05 \Omega)$ $\pm (2 \% R + 0.1 \Omega)$	$\pm (2 \% R + 0.1 \Omega)$ $\pm (4 \% R + 0.1 \Omega)$
4.18.2	58 (Td)	Resistance to soldering heat	Solder bath method; (260 $\pm$ 5) $^{\circ}$ C; (10 $\pm$ 1) s	$\pm (0.25 \% R + 0.05 \Omega)$	$\pm (0.5 \% R + 0.05 \Omega)$
4.35	-	Flammability, needle flame test	IEC 60695-11-5; 10 s	No burning after 30 s	
4.24	78 (Cab)	Damp heat, steady state	(40 $\pm$ 2) $^{\circ}$ C; (93 $\pm$ 3) % RH; 56 days	$\pm (1 \% R + 0.05 \Omega)$	
4.25.3	-	Endurance at upper category temperature	155 $^{\circ}$ C; 1000 h	$\pm (1 \% R + 0.05 \Omega)$	$\pm (2 \% R + 0.1 \Omega)$
4.40	-	Electrostatic discharge (human body model)	IEC 61340-3-1; 3 positive and 3 negative discharges; ESD voltage: 500 V	$\pm (1 \% R + 0.05 \Omega)$	
4.29	45 (XA)	Component solvent resistance	Isopropyl alcohol; 50 $^{\circ}$ C; method 2	No visible damage	
4.30	45 (XA)	Solvent resistance of marking	Isopropyl alcohol; 50 $^{\circ}$ C; method 1; toothbrush	Marking legible, no visible damage	
4.22	6 (Fc)	Vibration, endurance by sweeping	f = 10 Hz to 2000 Hz; x, y, z $\leq$ 1.5 mm; A $\leq$ 200 m/s <sup>2</sup> ; 10 sweeps per axis	$\pm (0.25 \% R + 0.05 \Omega)$	$\pm (0.5 \% R + 0.05 \Omega)$
4.37	-	Periodic electric overload	$U = \sqrt{15 \times P_{70} \times R} \leq 2 \times U_{max.}$ 0.1 s on; 2.5 s off; 1000 cycles	$\pm (1 \% R + 0.05 \Omega)$	
4.27	-	Single pulse high voltage overload, 10 $\mu$ s/700 $\mu$ s	$\dot{U} = 10 \times \sqrt{P_{70} \times R} \leq 2 \times U_{max.}$ 10 pulses	$\pm (1 \% R + 0.05 \Omega)$	

**Note**

<sup>(1)</sup> Figures are given for a single element.

All tests are carried out in accordance with the following specifications:

- EN 60115-1, generic specification
- EN 140400, sectional specification
- EN 140401-802, detail specification
- IEC 60068-2 environmental test procedures

Packaging of components is done in paper or blister tapes according to IEC 60286-3



## **Disclaimer**

ALL PRODUCT, PRODUCT SPECIFICATIONS AND DATA ARE SUBJECT TO CHANGE WITHOUT NOTICE TO IMPROVE RELIABILITY, FUNCTION OR DESIGN OR OTHERWISE.

Vishay Intertechnology, Inc., its affiliates, agents, and employees, and all persons acting on its or their behalf (collectively, "Vishay"), disclaim any and all liability for any errors, inaccuracies or incompleteness contained in any datasheet or in any other disclosure relating to any product.

Vishay makes no warranty, representation or guarantee regarding the suitability of the products for any particular purpose or the continuing production of any product. To the maximum extent permitted by applicable law, Vishay disclaims (i) any and all liability arising out of the application or use of any product, (ii) any and all liability, including without limitation special, consequential or incidental damages, and (iii) any and all implied warranties, including warranties of fitness for particular purpose, non-infringement and merchantability.

Statements regarding the suitability of products for certain types of applications are based on Vishay's knowledge of typical requirements that are often placed on Vishay products in generic applications. Such statements are not binding statements about the suitability of products for a particular application. It is the customer's responsibility to validate that a particular product with the properties described in the product specification is suitable for use in a particular application. Parameters provided in datasheets and / or specifications may vary in different applications and performance may vary over time. All operating parameters, including typical parameters, must be validated for each customer application by the customer's technical experts. Product specifications do not expand or otherwise modify Vishay's terms and conditions of purchase, including but not limited to the warranty expressed therein.

Except as expressly indicated in writing, Vishay products are not designed for use in medical, life-saving, or life-sustaining applications or for any other application in which the failure of the Vishay product could result in personal injury or death. Customers using or selling Vishay products not expressly indicated for use in such applications do so at their own risk. Please contact authorized Vishay personnel to obtain written terms and conditions regarding products designed for such applications.

No license, express or implied, by estoppel or otherwise, to any intellectual property rights is granted by this document or by any conduct of Vishay. Product names and markings noted herein may be trademarks of their respective owners.

## X-ON Electronics

Largest Supplier of Electrical and Electronic Components

*Click to view similar products for [Vishay](#) manufacturer:*

Other Similar products are found below :

[RER60F3010RC02](#) [RER75F2260PCSL](#) [RER75F6R49RC02](#) [RER70F75R0RC02](#) [RER65F5111RC02](#) [C52TF15R0JB](#) [VS-8ETH06PBF](#)  
[DG1413EQ-T1-GE3](#) [CRA04S0837K50JTD](#) [CRA06S08382K0JTA](#) [CRA06P08327R0JTA](#) [RER60F2430RC02](#) [RER70FR100MC02](#)  
[RER65F4870RC02](#) [RER50F18R7RC02](#) [M8340107K4751FGD03](#) [M8340108K1052FGD03](#) [CRA06S083180KJTA](#) [CRA06S083220KJTA](#)  
[DG211BDY](#) [CRA04S08368K0JTD](#) [VS-60EPS08PBF](#) [CRA06S0835K60JTA](#) [IH10EB600K12](#) [VS-MBRB1545CTPBF](#) [VS-60CTQ150-N3](#)  
[CNY651AGRST](#) [CRA04S0833K90JTD](#) [1KAB100E](#) [D55342H07B10E0RT5](#) [516D477M016MN6AE3](#) [BFC237852224](#) [VJ0402A4R7CNAAJ](#)  
[CRA04S08322K0JTD](#) [RS02C30K00FB12](#) [TLHK5400](#) [CRA04S08336R0JTD](#) [IRF644](#) [PTN0805H40R2BBT1](#) [516D227M016MM6AE3](#)  
[MKP1848C65090JY5L](#) [CRA04S08320K0JTD](#) [516D476M035LM6AE3](#) [CRA04S08318K0JTD](#) [SIA406DJ-T1-GE3](#) [CRA06P08318R0JTA](#)  
[CRA06S0834K30JTA](#) [CRA06S083360RJTA](#) [562R5GAD47RR](#) [VJ1825A223FXAAT](#)