







## SKINTOP® STR-M

SKINTOP® STR-M, increased oil-resistant plastic cable gland with permanent vibration protection and reducing seal insert

### Info

Now with IP69 approval! Proven to withstand the most demanding cleaning procedures for industrial machinery with high-pressure cleaners and hot water!



-  Variety of approval certifications
-  Temperature-resistant
-  Optimum strain relief
-  Assembly time
-  Mechanical resistance
-  Maximum vibration protection
-  Wide clamping range

### Application range

With reducing seal insert, to seal cables with smaller outer diameters.

### Norm references / Approvals

UL File Nr. E79903  
GGVS: TÜ.EGG.020-95

## SKINTOP® STR-M

### Product Make-up

Metric connection thread acc. to DIN EN 60423

Basis for technical information DIN IEC 62444

### Note

Refer to SKINTOP® metric accessories for suitable accessories

Counter nut to be used: SKINTOP® GMP-GL-M

SKINTOP® ST(R) M ISO types have an extra-long connection thread

SKINTOP® ST(R) M ISO versions with extra-long connection thread, see table, no DNV approval

### Technical Data

|                        |   |
|------------------------|---|
| Classification ETIM 5: | ETIM 5.0 Class-ID: EC000441<br>ETIM 5.0 Class-Description: Cable screw gland      |
| Classification ETIM 6: | ETIM 6.0 Class-ID: EC000441<br>ETIM 6.0 Class-Description: Cable screw gland      |
| Caution:               | Refer to Appendix T21 for the installation dimensions and torques                 |
| Colour delivered:      | Silver grey (RAL 7001)<br>Light grey (RAL 7035)<br>Black (RAL 9005), UV-resistant |
| Material:              | Body: Polyamide<br>Seal: CR   |
| Tests:                 | GGVS: TÜ.EGG.020-95   |
| Protection rating:     | IP 68 - 5 bar<br>IP 69  |
| Temperature range:     | Fixed: -40 °C to +100 °C<br>Dynamic: -20 °C to +100 °C                            |

### Note

Photographs and graphics are not to scale and do not represent detailed images of the respective products.

Prices are net prices without VAT and surcharges. Sale to business customers only.

| Article number   | Article designation / size | Clamping range ØF (mm) | SW wrench size mm | Overall length, C (mm) |
|--|----------------------------|------------------------|-------------------|------------------------|
| <b>SKINTOP® STR-M silver grey</b>  |                            |                        |                   |                        |
| 53111100   | M 12 x 1,5                 | 2 - 5                  | 15                | 30.0                   |
| 53111110   | M 16 x 1,5                 | 3.5 - 7                | 19                | 34.0                   |
| 53111120   | M 20 x 1,5                 | 4 - 10                 | 25                | 37.0                   |
| 53111130   | M 25 x 1,5                 | 5 - 13                 | 30                | 40.0                   |
| 53111140   | M 32 x 1,5                 | 6 - 15                 | 36                | 47.0                   |
| 53111150   | M 40 x 1,5                 | 9 - 23                 | 46                | 52.0                   |
| 53111160   | M 50 x 1,5                 | 24 - 29                | 55                | 62.0                   |
| 53111170   | M 63 x 1,5                 | 28 - 39                | 66                | 71.0                   |
| <b>SKINTOP® STR-M black</b>  |                            |                        |                   |                        |
| 53111300   | M 12 x 1,5                 | 2 - 5                  | 15                | 30.0                   |
| 53111310   | M 16 x 1,5                 | 3.5 - 7                | 19                | 34.0                   |
| 53111320   | M 20 x 1,5                 | 4 - 10                 | 25                | 37.0                   |
| 53111330   | M 25 x 1,5                 | 5 - 13                 | 30                | 40.0                   |
| 53111340   | M 32 x 1,5                 | 6 - 15                 | 36                | 47.0                   |
| 53111350   | M 40 x 1,5                 | 9 - 23                 | 46                | 52.0                   |
| 53111360   | M 50 x 1,5                 | 24 - 29                | 55                | 62.0                   |
| 53111370   | M 63 x 1,5                 | 28 - 39                | 66                | 71.0                   |
| <b>SKINTOP® STR-M light grey</b>   |                            |                        |                   |                        |
| 53111500   | M 12 x 1,5                 | 2 - 5                  | 15                | 30.0                   |
| 53111510   | M 16 x 1,5                 | 3.5 - 7                | 19                | 34.0                   |
| 53111520   | M 20 x 1,5                 | 4 - 10                 | 25                | 37.0                   |
| 53111530   | M 25 x 1,5                 | 5 - 13                 | 30                | 40.0                   |
| 53111540   | M 32 x 1,5                 | 6 - 15                 | 36                | 47.0                   |
| 53111550   | M 40 x 1,5                 | 9 - 23                 | 46                | 52.0                   |
| 53111560   | M 50 x 1,5                 | 24 - 29                | 55                | 62.0                   |
| 53111570   | M 63 x 1,5                 | 28 - 39                | 66                | 71.0                   |
| <b>SKINTOP® STR M ISO silver-grey (with long metric connecting thread)</b> |                            |                        |                   |                        |
| 53017110   | M 16 x 1,5 ISO             | 2 - 6                  | 19                | 40.0                   |
| 53017130   | M 20 x 1,5 ISO             | 4 - 9                  | 24                | 45.0                   |
| 53017140   | M 25 x 1,5 ISO             | 6 - 12                 | 27                | 47.0                   |
| <b>SKINTOP® STR M ISO black (with long metric connecting thread)</b>       |                            |                        |                   |                        |
| 53017310   | M 16 x 1,5 ISO             | 2 - 6                  | 19                | 40.0                   |
| 53017330   | M 20 x 1,5 ISO             | 4 - 9                  | 24                | 45.0                   |
| 53017340   | M 25 x 1,5 ISO             | 6 - 12                 | 27                | 47.0                   |

## SKINTOP® STR-M

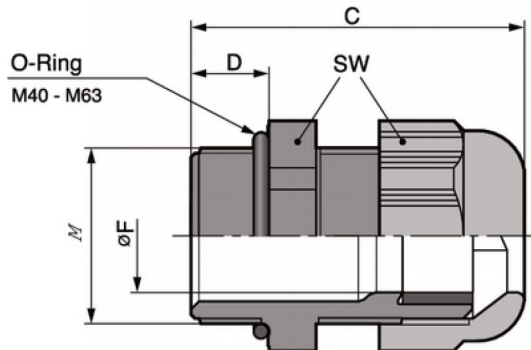

## X-ON Electronics

Largest Supplier of Electrical and Electronic Components

*Click to view similar products for [Cable Glands, Strain Reliefs & Cord Grips](#) category:*

*Click to view products by [Lapp Kabel](#) manufacturer:*

Other Similar products are found below :

[120-116-1-1-20BP](#) [120-116-1-1-32BE](#) [120-117-40](#) [120-123-14](#) [120-123-16](#) [120-125-16](#) [120-125-16R](#) [120-125-16Y](#) [120-125-24Y](#) [120-125-28](#) [120-125-28R](#) [120-125-32](#) [120-125-32R](#) [120-125-40](#) [120-125-56](#) [120-126-14](#) [120-126-16](#) [120-126-20](#) [120-126-20BL](#) [120-126-20R](#) [120-126-24](#) [120-126-28](#) [120-126-32](#) [120-126-40BL](#) [120-116-1-1-06BP-509](#) [120-116-1-1-06CP](#) [120-116-1-1-16BE](#) [120-116-1-1-28BP](#) [120-123-20](#) [120-123-24](#) [120-123-32](#) [120-125-20](#) [120-125-20Y](#) [120-125-24](#) [120-125-24R](#) [120-125-28Y](#) [120-126-14BL](#) [120-126-16R](#) [120-126-16Y](#) [120-126-24BL](#) [120-126-28BL](#) [120-126-32BL](#) [120-126-40](#) [120-126-48](#) [120-126-48BL](#) [1300980012](#) [1300980105](#) [DBZM-6828](#) [1498](#) [15190-103 R2](#)