

Kumanda Butonlari ve Sinyal Lambalari

Control Units and
Pilot Lights

Kumanda Butonları ve Sinyal Lambaları

Control Units and Pilot Lights



B Serisi Ø 22mm Kumanda Butonları (IP50)

Genel Özellikler ve Teknik Bilgiler	4
Genel Şema	5
Seçim Tablosu	6
Buton Tipleri	8
Kontakt Blok Tipleri	14
Yedekler	15
Aksesuarlar	17
Montaj Şekli ve Boyutlar	18

B Series Ø 22mm Control Units (IP50)

General Specifications and Technical Information	4
General Scheme	5
Selection Table	5
Control Unit Types	8
Contact Block Types	14
Spare Parts	15
Accessories	17
Assembly and Dimensions	18

CM Metal Serisi Ø 22mm Kumanda Butonları (IP65)

Genel Özellikler ve Teknik Bilgiler	19
Genel Şema	20
Seçim Tablosu	22
Buton Tipleri	24
Kontakt Blok Tipleri	29
Yedekler	30
Aksesuarlar	31
Montaj Şekli ve Boyutlar	32

CM Metal Series Ø 22mm Control Units (IP65)

General Specifications and Technical Information	19
General Scheme	20
Selection Table	22
Control Unit Types	24
Contact Block Types	29
Spare Parts	30
Accessories	31
Assembly and Dimensions	32

CP Plastik Serisi Ø 22mm Kumanda Butonları (IP65)

Genel Özellikler ve Teknik Bilgiler	33
Genel Şema	34
Seçim Tablosu	36
Buton Tipleri	38
Kontakt Blok Tipleri	43
Yedekler	44
Aksesuarlar	45
Montaj Şekli ve Boyutlar	47

CP Plastic Series Ø 22mm Control Units (IP65)

General Specifications and Technical Information	33
General Scheme	34
Selection Table	36
Control Unit Types	38
Contact Block Types	43
Spare Parts	44
Accessories	45
Assembly and Dimensions	47

D Serisi Ø 16mm Kumanda Butonları (IP50)

Genel Özellikler ve Teknik Bilgiler	48
Genel Şema	49
Seçim Tablosu	50
Buton Tipleri	51
Kontakt Blok Tipleri	53
Yedekler	53
Aksesuarlar	53
Montaj Şekli ve Boyutlar	54

D Series Ø 16mm Control Units (IP50)

General Specifications and Technical Information	48
General Scheme	49
Selection Table	50
Control Unit Types	51
Contact Block Types	53
Spare Parts	53
Accessories	53
Assembly and Dimensions	54

Kumanda Butonları ve Sinyal Lambaları

Control Units and Pilot Lights



H Serisi Ø 30mm Kumanda Butonları (IP50)

Genel Özellikler ve Teknik Bilgiler	55
Genel Şema	56
Seçim Tablosu	57
Buton Tipleri	58
Kontakt Blok Tipleri	60
Montaj Şekli ve Boyutlar	61

H Series Ø 30mm Control Units (IP50)

General Specifications and Technical Information	55
General Scheme	56
Selection Table	57
Control Unit Types	58
Contact Block Types	60
Assembly and Dimensions	61

MB Monoblok Serisi Ø 22mm Kumanda Butonları (IP50)

Genel Özellikler ve Teknik Bilgiler	62
Genel Şema	63
Seçim Tablosu	64
Buton Tipleri	65
Aksesuarlar	67
Montaj Şekli ve Boyutlar	68

MB Monoblock Series Ø 22mm Control Units (IP50)

General Specifications and Technical Information	62
General Scheme	63
Selection Table	64
Control Unit Types	65
Accessories	67
Assembly and Dimensions	68

KB Serisi Ø 22mm Kumanda Butonları (IP50)

Genel Özellikler ve Teknik Bilgiler	69
Genel Şema	70
Seçim Tablosu	71
Buton Tipleri	72
Kontakt Blok Tipleri	74
Yedekler	74
Montaj Şekli ve Boyutlar	75

KB Series Ø 22mm Control Units (IP50)

General Specifications and Technical Information	69
General Scheme	70
Selection Table	71
Control Unit Types	72
Contact Block Types	74
Spare Parts	74
Assembly and Dimensions	75

Sinyal Lambaları

Genel Özellikler ve Teknik Bilgiler	76
Sinyal Tipleri	77
Ampuller	79
Boyutlar	80

Pilot Lights

General Specifications and Technical Information	76
Pilot Light Types	77
Neon Lamps	79
Dimensions	80



B Serisi Ø 22mm Kumanda Butonları

- Maksimum güvenlik için parmak koruma
- Darbe dayanıklı polikarbonat buton lensi
- Alev almayan VO PA6.6 kontak bloklar
- İstenildiğinde çeşitli ışıklı kontak blokların uygunluğu
- Adaptöre kontak blokların takılmasında alete ihtiyaç olmaması
- Led ışıkla, minimum ısınma maksimum ömür
- Arka arkaya 2 kontak blok takılabilir
- Farklı dillerde ve özel işaretli çeşitli markalama etiketleri
- Tüm uygulamalara cevap verecek ürün çeşitliliği.

Teknik Bilgiler

Mekanik Ömür	: 500.000 açma-kapama min.
Elektriksel Ömür	: 100.000 açma-kapama min.
Çalışma Sıcaklığı	: min./maks. °C -5/+40
Koruma Sınıfı	: IP50
Çalışma Sıklığı	: Yüksüz 3.000 açma-kapama/saat
	: Yükte 1.200 açma-kapama/saat
Çalışma Gerilimi (Ue)	: 250 V AC
Çalışma Akımı (Ie)	: 4 A
Yalıtım Gerilimi (Ui)	: 300 V
Darbe Dayanım Gerilimi (Uimp)	: 2.5 kV
Kısa Devre Kesme Kap. (Icn)	: 1 kA
İzolasyon Direnci	: 10 MΩ min. (500 V DC)
Kullanım Sınıfı	: AC15
Dielektrik Mukavemeti	: 1.500 V AC (1 dakika için)
Standart Kontak Malzemesi	: AgNi
Bağlantı Kablo Kesiti	: 1.5 - 2.5 mm ²
Standart	: UL 508 TS EN 60947-5-1 VDE0660
	: IEC 60393-1 (BPR Potansiyometre için)



B Series Ø 22mm Control Units

- Finger safe protection for maximum safety
- Impact-resistant polycarbonate button lens
- Non-flammable VO PA6.6 contact blocks
- Various illumination contact blocks availability on request
- Tools not required to attach contact blocks to adapter
- With LED illumination, minimum warm-up and maximum lifetime.
- Contact blocks can be stacked by two blocks deep.
- Various legend plates with different languages and custom markings
- Variety of products for all areas of application

Technical Information

Mechanical Life	: 500.000 operations min.
Electrical Life	: 100.000 operations min.
Operating Temperature	: min./max. °C -5/+40
Protection Degree	: IP50
Operating Frequency	: Without load 3.000 operations/hour
	: At full load 1.200 operations/hour
Operating Voltage (Ue)	: 250 V AC
Operating Current (Ie)	: 4 A
Insulation Voltage (Ui)	: 300 V
Impact Resistance (Uimp)	: 2.5 kV
Short Circuit Breaking Capacity (Icn)	: 1 kA
Insulation Resistance	: 10 MΩ min. (500 V DC)
Utilization Category	: AC15
Dielectric Strength	: 1.500 V AC (1 for minute)
Standard Contact Material	: AgNi
Cable Section	: 1.5 - 2.5 mm ²
Standard	: UL 508 TS EN 60947-5-1 VDE0660
	: IEC 60393-1 (For BPR Potentiometer)



Kumanda Butonları ve Sinyal Lambaları

Control Units and Pilot Lights

B Serisi Ø 22mm Kumanda Butonları Genel Şema

B Series Ø 22mm Control Units General Scheme

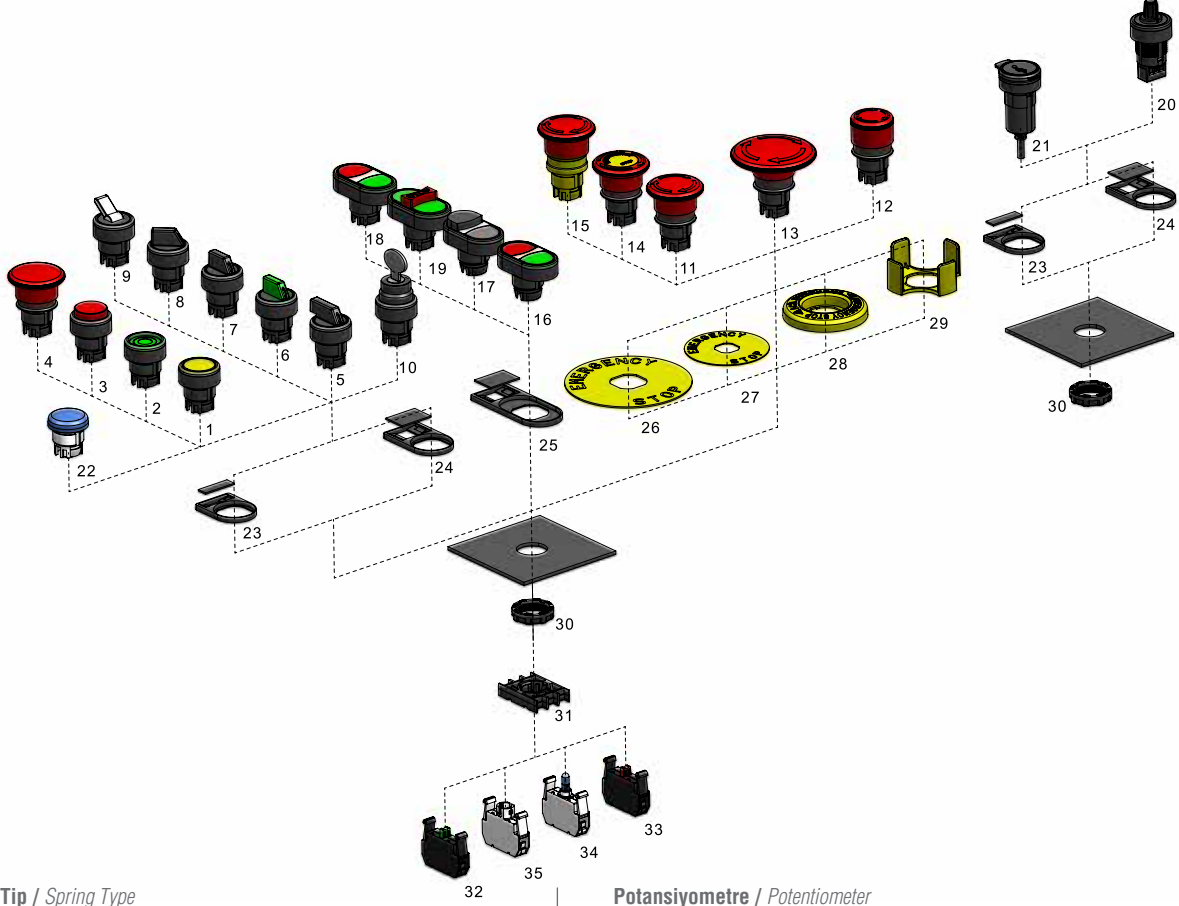

Yaylı Tip / Spring Type

- 1 D Düz / Flush
- 2 F Kalıcı / Stay Put
- 3 H Çıkık / Extended
- 4 M Mantar, Ø 40 mm / Mushroom, Ø 40 mm

Seçici Tip / Selector Type

- 5 S 60° / 60°
- 6 SL Işıklı, 60° / Illuminated, 60°
- 7 R 45° / 45°
- 8 T 90° / 90°
- 9 C Mandallı / Handle

10 Anahtarlı Tip / Key Operated Type

Acil Stop / Emergency Stop

- 11 E Ø 40mm, Çevirmeli / Ø 40mm, Turn to Release
- 12 E30 Ø 30mm, Çevirmeli / Ø 30mm, Turn to Release
- 13 E60 Ø 60mm, Çevirmeli / Ø 60mm, Turn to Release
- 14 EE Ø 40mm, Etiketli, Çevirmeli / Ø 40mm, With Label, Turn to Release
- 15 EG Ø 40mm, Pozisyon, Göstergeli / Ø 40mm, With Position Cursor

Çiftli / Double

- 16 K20 Düz Kafalı / Flush
- 17 K21 1 Çıkık Kafalı / Single Extended
- 18 B20 Büyük Düz Kafalı / Big Flush
- 19 B30 Üçüz Buton, 1 Çıkık Kafalı, Stop / Triple, Single Extended, Stop

Potansiyometre / Potentiometer

- 20 BPR

- 21 USB

Sinyal / Pilots

- 22 X Yuvarlak, Sinyal / Round, Pilots

Aksesuarlar / Accessories

- 23 BROZET08 Rozet, 8mm / Legend Plate Holder, 8mm
- 24 BROZET18 Rozet, 18mm / Legend Plate Holder, 18mm
- 25 BCIFTLIROZET18 Rozet, İki Buton, 18mm / Legend Plate Holder, Double, 18mm
- 26 BET90A/P Etiket, Ø90mm Acil Stop, Alüminyum Plastik / Legend Plate, Ø90mm Emergency Stop, Aluminium / Plastic
- 27 BET60A/P Etiket, Ø60mm Acil Stop, Alüminyum/Plastik / Legend Plate, Ø60mm Emergency Stop, Aluminium/Plastic
- 28 BET60LED Etiket, Ø60mm Acil Stop, LED / LED Illuminated Legend Plate, Ø60mm Emergency Stop
- 29 BMUHAFAZA Emniyet Koruma / Emergency Protective Cover
- 30 SOMUN Plastic Somun, M22 X 1,5 / Plastic Nut, M22 X 1,5
- 31 ADAPTÖR Adaptör / Adapter
- 32 START KONTAKBLOK Kontak Blok, Start (NA) / Contact Block, Start (NO)
- 33 STOP KONTAKBLOK Kontak Blok, Stop (NK) / Contact Block, Stop (NC)
- 34 LED KONTAK BLOK Kontak Blok, LED / Contact Block, LED
- 35 AMPULLU LED Ba9S Duylu Işık Kontak Blok / Lampholder for Ba9S Bulbs

Kumanda Butonları ve Sinyal Lambaları

Control Units and Pilot Lights



B Serisi Kumanda Butonlar Seçim Tablosu

Series Control Units Selection Table

Seri	Kontakt Blok Kombinasyonu	Buton Tipi
B	1 K 2	D
Series	Contact Block Combination	Button Type
Seri Series	Işık Bloğu Tipi Illumination Block Type	Buton Tipi Button Type
B Serisi Ø 22mm Kumanda Butonu Series Ø 22mm Control Units	0 Boş Without Illumination	D Düz Flush
	3 Işık Blok Illumination Block	F Kalıcı Stay Put
	5 12 - 30V AC/DC 12 - 30V AC/DC	H Çıkık Extended
	6 12 - 30V AC/DC 12 - 30V AC/DC	M Mantar Mushroom
	7 12 - 30V AC/DC 12 - 30V AC/DC	Ø 40 mm Ø 40 mm
	8 12 - 30V AC/DC 12 - 30V AC/DC	
	9 12 - 30V AC/DC 12 - 30V AC/DC	
	B 100 - 230V AC 100 - 230V AC	
	K 100 - 230V AC 100 - 230V AC	
	M 100 - 230V AC 100 - 230V AC	
	S 100 - 230V AC 100 - 230V AC	
	Y 100 - 230V AC 100 - 230V AC	
	Q Özel Gerilim Special Voltage	
	X Özel Gerilim Special Voltage	
	V Özel Gerilim Special Voltage	
	W Özel Gerilim Special Voltage	
	Z Özel Gerilim Special Voltage	
	Kontakt Blok Tipi Contact Block Type	
	0 Boş Empty	
	1 Start Butonluk Start For Button	
	2 Stop Butonluk Stop For Button	
	Buton Tipi Button Type	
	Yaylı Tip Spring Type	
	D Düz Flush	
	F Kalıcı Stay Put	
	H Çıkık Extended	
	M Mantar Mushroom	
	Seçici Tip Selector Type	
	S20 2 Pozisyonlu 2 Position	Kalıcı Stay Put
	S21 2 Pozisyonlu 2 Position	Dönüşlü Spring Return
	S30 3 Pozisyonlu 3 Position	Kalıcı Stay Put
	S31 3 Pozisyonlu 3 Position	Tek Dönüşlü Single Spring Return
	S32 3 Pozisyonlu 3 Position	Çift Dönüşlü Double Spring Return
	SL20 2 Pozisyonlu 2 Position	Işıklı Illuminated
	SL21 2 Pozisyonlu 2 Position	Işıklı Illuminated
	SL30 3 Pozisyonlu 3 Position	Işıklı Illuminated
	SL31 3 Pozisyonlu 3 Position	Işıklı Illuminated
	SL32 3 Pozisyonlu 3 Position	Işıklı Illuminated
	R20 2 Pozisyonlu 2 Position	Kalıcı Stay Put
	R21 2 Pozisyonlu 2 Position	Dönüşlü Spring Return
	T20 2 Pozisyonlu 2 Position	Kalıcı Stay Put
	T21 2 Pozisyonlu 2 Position	Dönüşlü Spring Return
	C Mandallı Handle	

Kumanda Butonları ve Sinyal Lambaları

Control Units and Pilot Lights



Renk



Colour

Yazı



Pad Printing

Anahtarlı Tip

Key Operated Type

AA20	2 Pozisyonlu 2 Position	0 Pozisyonunda Anahtarı Çıkan Key Removal at 0 Position	Kalıcı Stay Put	(0-1) (0-1)	60° 60°	✓
AA21	2 Pozisyonlu 2 Position	0 Pozisyonunda Anahtarı Çıkan Key Removal at 0 Position	Dönüşlü Spring Return	(0-1) (0-1)	60° 60°	✓
AA30	3 Pozisyonlu 3 Position	0 Pozisyonunda Anahtarı Çıkan Key Removal at 0 Position	Kalıcı Stay Put	(II-0-1) (II-0-1)	60° 60°	✓
AA31	3 Pozisyonlu 3 Position	0 Pozisyonunda Anahtarı Çıkan Key Removal at 0 Position	Tek Dönüşlü Single Spring Return	(II-0-1) (II-0-1)	60° 60°	✓
AA32	3 Pozisyonlu 3 Position	0 Pozisyonunda Anahtarı Çıkan Key Removal at 0 Position	Çift Dönüşlü Double Spring Return	(II-0-1) (II-0-1)	60° 60°	✓
AC20	2 Pozisyonlu 2 Position	Tüm Pozisyonlarda Anahtarı Çıkan Key Removal at all Positions	Kalıcı Stay Put	(0-1) (0-1)	60° 60°	✓
AC30	3 Pozisyonlu 3 Position	Tüm Pozisyonlarda Anahtarı Çıkan Key Removal at all Positions	Kalıcı Stay Put	(II-0-1) (II-0-1)	60° 60°	✓
AC31	3 Pozisyonlu 3 Position	Tüm Pozisyonlarda Anahtarı Çıkan Key Removal at all Positions	Tek Dönüşlü Single Spring Return	(II-0-1) (II-0-1)	60° 60°	✓
AC32	3 Pozisyonlu 3 Position	Tüm Pozisyonlarda Anahtarı Çıkan Key Removal at all Positions	Çift Dönüşlü Double Spring Return	(II-0-1) (II-0-1)	60° 60°	✓

Acil Stop Tip

Emergency Stop Type

E	Ø 40mm Ø 40mm	Çevirmeli Turn to Release
E30	Ø 30mm Ø 30mm	Çevirmeli Turn to Release
E60	Ø 60mm Ø 60mm	Çevirmeli Turn to Release
EE	Ø 40mm Ø 40mm	Etiketli With Label
EG	Ø 40mm Ø 40mm	Pozisyon Göstergeli With Position Cursor

Çiftli Tip

Double Type

K20	Düz Kafalı Flush
K21	1 Çıkık Kafalı Single Extended
B20	Büyük Düz Kafalı Big Flush
B30	Üçüz Buton Triple
	1 Çıkık Kafalı Single Extended
	Stop Stop

Sinyal

Pilots

X	Sinyal Pilot Lights
----------	------------------------

B	Beyaz White
K	Kırmızı Red
M	Mavi Blue
S	Sarı Yellow
Y	Yeşil Green
H	Siyah Black
BB	Beyaz White
HB	Siyah Black
HH	Siyah Black
KY	Kırmızı Red
SS	Sarı Yellow
YY	Yeşil Green

Beyaz White
Beyaz White
Siyah Black
Siyah Black
Yeşil Green
Sarı Yellow
Yeşil Green

0	0 0	Yazılı Printed
10	I-0 I-0	Yazılı Printed
1	I I	Yazılı Printed
2	II II	Yazılı Printed
12	I-II I-II	Yazılı Printed
L	LIGHT LIGHT	Yazılı Printed
OD	OK Vertical Arrow	Dikey Yazılı Printed
OY	OK Horizontal Arrow	Yatay Yazılı Printed
OK	OK Special Arrow	Özel Yazılı Printed
OO	OK Special Arrow	Özel Yazılı Printed
S	Siren İşareti Siren Symbol	Printed
Z	Zil İşareti Bell Symbol	Printed

Örnek: B1K2DK → Örnek olarak B serisi, start-stop, 100-230 V AC/DC kırmızı ledli, kırmızı renkli, düz buton seçilmiştir.

Example: B1K2DK → B series, start-stop, 100-230 V AC/DC with red led, red coloured, Flush type button has been selected.

Kumanda Butonları ve Sinyal Lambaları





















Control Units and Pilot Lights



B Serisi Ø 22 mm Adaptörlü Kumanda Butonu Tipleri

Series Ø 22 mm Push Buttons With Adapter

Yaylı Tip Kumanda Butonlar / Spring Type Control Units

Ürün Kodu	Kontakt Blok Tipi		Işık	Buton Tipi	Renk
Code	Contact Block Type		Illumination	Button Type	Colour
B100D*	 Normal Açık Normally Open	-	✓	Düz / Flush	
B101D*	2	-	✓	Düz / Flush	
B102D*	1	1	✓	Düz / Flush	
B200D*	-	1	✓	Düz / Flush	
B202D*	-	2	✓	Düz / Flush	
B100F*	1	-	✓	Kalıcı / Stay Put	
B101F*	2	-	✓	Kalıcı / Stay Put	
B102F*	1	1	✓	Kalıcı / Stay Put	
B200F*	-	1	✓	Kalıcı / Stay Put	
B202F*	-	2	✓	Kalıcı / Stay Put	
B100H*	1	-	✓	Çıkık / Extended	
B101H*	2	-	✓	Çıkık / Extended	
B102H*	1	1	✓	Çıkık / Extended	
B200H*	-	1	✓	Çıkık / Extended	
B202H*	-	2	✓	Çıkık / Extended	
B100M*	1	-	-	Mantar / Mushroom	
B101M*	2	-	-	Mantar / Mushroom	
B102M*	1	1	-	Mantar / Mushroom	
B200M*	-	1	-	Mantar / Mushroom	
B202M*	-	2	-	Mantar / Mushroom	

• (*) yerine istenen rengin harfi eklenir.

• Please choose the colour and replace (*) with the letter.

• Işık Bloğu seçenekleri için bakınız sayfa 6 Kumanda Butonları Seçim Tablosu.

• See page 6 Control Units Selection table for illumination block types.



B100DY



B100FY



B200HK





B200MK

Kumanda Butonları ve Sinyal Lambaları

Control Units and Pilot Lights



Seçici Tip Kumanda Butonları / Selector Type Control Units

Ürün Kodu	Kontakt Blok Tipi	Işık	Etiket	Buton Tipi	Pozisyon	Renk	
Code	Contact Block Type	Illumination	Button Plates	Button Type	Position	Colour	
	 Normal Açık Normally Open	 Normal Kapalı Normally Closed	LED LED				
B100S20	1	-	-	0-I	Seçici / Selector	2 Pozisyonlu-Kalıcı-60° / 2 Position-Stay Put-60°	H
B101S20	2	-	-	0-I	Seçici / Selector	2 Pozisyonlu-Kalıcı-60° / 2 Position-Stay Put-60°	H
B102S20	1	1	-	0-I	Seçici / Selector	2 Pozisyonlu-Kalıcı-60° / 2 Position-Stay Put-60°	H
B100S21	1	-	-	0-I	Seçici / Selector	2 Pozisyonlu-Dönüşlü-60° / 2 Position-Spring Return-60°	H
B101S21	2	-	-	0-I	Seçici / Selector	2 Pozisyonlu-Dönüşlü-60° / 2 Position-Spring Return-60°	H
B102S21	1	1	-	0-I	Seçici / Selector	2 Pozisyonlu-Dönüşlü-60° / 2 Position-Spring Return-60°	H
B101S30	2	-	-	II-0-I	Seçici / Selector	3 Pozisyonlu-Kalıcı -60° / 3 Position-Stay Put-60°	H
B102S30	1	1	-	II-0-I	Seçici / Selector	3 Pozisyonlu-Kalıcı -60° / 3 Position-Stay Put-60°	H
B101S31	2	-	-	II-0-I	Seçici / Selector	3 Pozisyonlu-Tek Dönüşlü-60° / 3 Position-Single Spring Return-60°	H
B102S31	1	1	-	II-0-I	Seçici / Selector	3 Pozisyonlu-Tek Dönüşlü-60° / 3 Position-Single Spring Return-60°	H
B101S32	2	-	-	II-0-I	Seçici / Selector	3 Pozisyonlu-Çift Dönüşlü -60° / 3 Position-Double Spring Return-60°	H
B102S32	1	1	-	II-0-I	Seçici / Selector	3 Pozisyonlu-Çift Dönüşlü-60° / 3 Position-Double Spring Return-60°	H
B100SL20*	1	-	✓	0-I	Seçici / Selector	2 Pozisyonlu-Işıklı -Kalıcı-60° / 2 Position-Illuminated-Stay Put-60°	B K M S Y H
B101SL20*	2	-	✓	0-I	Seçici / Selector	2 Pozisyonlu-Işıklı -Kalıcı-60° / 2 Position-Illuminated-Stay Put-60°	B K M S Y H
B100SL21*	1	-	✓	0-I	Seçici / Selector	2 Pozisyonlu-Işıklı -Dönüşlü -60° / 2 Position-Illuminated-Spring Return-60°	B K M S Y H
B101SL21*	2	-	✓	0-I	Seçici / Selector	2 Pozisyonlu-Işıklı -Dönüşlü -60° / 2 Position-Illuminated-Spring Return-60°	B K M S Y H
B101SL30*	2	-	✓	II-0-I	Seçici / Selector	3 Pozisyonlu-Işıklı-Kalıcı-60° / 3 Position-Illuminated-Stay Put-60°	B K M S Y H
B101SL31*	2	-	✓	II-0-I	Seçici / Selector	3 Pozisyonlu-Işıklı-Tek Dönüşlü-60° / 3 Position-Illuminated-Single Spring Return-60°	B K M S Y H
B102SL31*	1	1	✓	II-0-I	Seçici / Selector	3 Pozisyonlu-Işıklı-Tek Dönüşlü-60° / 3 Position-Illuminated-Single Spring Return-60°	B K M S Y H
B101SL32*	2	-	✓	II-0-I	Seçici / Selector	3 Pozisyonlu-Işıklı-Çift Dönüşlü-60° / 3 Position-Illuminated-Double Spring Return-60°	B K M S Y H
B102SL32*	1	1	✓	II-0-I	Seçici / Selector	3 Pozisyonlu-Işıklı-Çift Dönüşlü-60° / 3 Position-Illuminated-Double Spring Return-60°	B K M S Y H
B100R20	1	-	-	0-I	Seçici / Selector	2 Pozisyon-Kalıcı-45° / 2 Position-Stay Put-45°	H
B101R20	2	-	-	0-I	Seçici / Selector	2 Pozisyon-Kalıcı-45° / 2 Position-Stay Put-45°	H
B100R21	1	-	-	0-I	Seçici / Selector	2 Pozisyon-Dönüşlü-45° / 2 Position-Spring Return-45°	H
B101R21	2	-	-	0-I	Seçici / Selector	2 Pozisyon-Dönüşlü-45° / 2 Position-Spring Return-45°	H
B100T20	1	-	-	0-I	Seçici / Selector	2 Pozisyonlu-Kalıcı-90° / 2 Position-Stay Put-90°	H
B101T20	2	-	-	0-I	Seçici / Selector	2 Pozisyonlu-Kalıcı-90° / 2 Position-Stay Put-90°	H
B100T21	1	-	-	0-I	Seçici / Selector	2 Pozisyonlu-Kalıcı-90° / 2 Position-Stay Put-90°	H
B101T21	2	-	-	0-I	Seçici / Selector	2 Pozisyonlu-Dönüşlü-90° / 2 Position-Spring Return-90°	H
B100C	1	-	-	-	Mandallı / Handle Switch	-	B
B102C	1	1	-	-	Mandallı / Handle Switch	-	B
B200C	-	1	-	-	Mandallı / Handle Switch	-	B

- Işık Bloğu seçenekleri için bakınız sayfa 6 Kumanda Butonları Seçim Tablosu.
- See page 6 Control Units Selection table for illumination block types.



B100S20



B100SL20Y



B131SL30Y



B101T20



B101R20



B100C

Kumanda Butonları ve Sinyal Lambaları

Control Units and Pilot Lights



B Serisi Ø 22 mm Adaptörlü Kumanda Butonu Tipleri

Series Ø 22 mm Push Buttons With Adapter

Anahtarlı Tip Kumanda Butonları / Key Operated Type Control Units

Ürün Kodu	Kontakt Blok Tipi	Işık	Etiket	Tip	Pozisyon	Anahtar Çıkma Pozisyonu		
Code	Contact Block Type	Illumination	Button Plates	Type	Position	Key Removal Position		
	 Normal Açık Normally Open	 Normal Kapalı Normally Closed	LED LED					
B100AA20	1	-	-	0-I	Kalıcı / Stay Put	2 Pozisyonlu / 2 Position	✓	0
B101AA20	2	-	-	0-I	Kalıcı / Stay Put	2 Pozisyonlu / 2 Position	✓	0
B102AA20	1	1	-	0-I	Kalıcı / Stay Put	2 Pozisyonlu / 2 Position	✓	0
B100AA21	1	-	-	0-I	Dönüştü / Spring Return	2 Pozisyonlu / 2 Position	↕	0
B101AA21	2	-	-	0-I	Dönüştü / Spring Return	2 Pozisyonlu / 2 Position	↕	0
B102AA21	1	1	-	0-I	Dönüştü / Spring Return	2 Pozisyonlu / 2 Position	↕	0
B101AA30	2	-	-	II-0-I	Kalıcı / Stay Put	3 Pozisyonlu / 3 Position	✓	0
B102AA30	1	1	-	II-0-I	Kalıcı / Stay Put	3 Pozisyonlu / 3 Position	✓	0
B101AA31	2	-	-	II-0-I	Tek Dönüştü / Single Spring Return	3 Pozisyonlu / 3 Position	↕	0
B102AA31	1	1	-	II-0-I	Tek Dönüştü / Single Spring Return	3 Pozisyonlu / 3 Position	↕	0
B101AA32	2	-	-	II-0-I	Çift Dönüştü / Double Spring Return	3 Pozisyonlu / 3 Position	↕	0
B102AA32	1	1	-	II-0-I	Çift Dönüştü / Double Spring Return	3 Pozisyonlu / 3 Position	↕	0
B100AC20	1	-	✓	0-I	Kalıcı / Stay Put	2 Pozisyonlu / 2 Position	✓	Tüm / All
B101AC20	2	-	✓	0-I	Kalıcı / Stay Put	2 Pozisyonlu / 2 Position	✓	Tüm / All
B102AC20	1	1	✓	0-I	Kalıcı / Stay Put	2 Pozisyonlu / 2 Position	✓	Tüm / All
B100AC21	1	-	✓	0-I	Dönüştü / Spring Return	2 Pozisyonlu / 2 Position	↕	Tüm / All
B101AC21	2	-	✓	0-I	Dönüştü / Spring Return	2 Pozisyonlu / 2 Position	↕	Tüm / All
B102AC21	1	1	✓	0-I	Dönüştü / Spring Return	2 Pozisyonlu / 2 Position	↕	Tüm / All
B101AC30	2	-	✓	II-0-I	Kalıcı / Stay Put	3 Pozisyonlu / 3 Position	✓	Tüm / All
B102AC30	1	1	✓	II-0-I	Kalıcı / Stay Put	3 Pozisyonlu / 3 Position	✓	Tüm / All
B101AC31	2	-	✓	II-0-I	Tek Dönüştü / Single Spring Return	3 Pozisyonlu / 3 Position	↕	Tüm / All
B102AC31	1	1	-	II-0-I	Tek Dönüştü / Single Spring Return	3 Pozisyonlu / 3 Position	↕	Tüm / All
B101AC32	2	-	-	II-0-I	Çift Dönüştü / Double Spring Return	3 Pozisyonlu / 3 Position	↕	Tüm / All
B102AC32	1	1	-	II-0-I	Çift Dönüştü / Double Spring Return	3 Pozisyonlu / 3 Position	↕	Tüm / All





B102AA31

Kumanda Butonları ve Sinyal Lambaları

Control Units and Pilot Lights



Acil Stop Tip Kumanda Butonları / Emergency Stop Type Control Units

Ürün Kodu	Kontakt Blok Tipi		Etiket	Tip	Çap (mm)	Renk
Code	Contact Block Type		Button Plates	Type	Dia (mm)	Colour
						
	Normal Açık Normally Open	Normal Kapalı Normally Closed				
B100E	1	-		Çevirmeli / Turn to Release	Ø 40mm	K
B102E	1	1		Çevirmeli / Turn to Release	Ø 40mm	K
B200E	-	1		Çevirmeli / Turn to Release	Ø 40mm	K
B202E	-	2		Çevirmeli / Turn to Release	Ø 40mm	K
B100EE	1	-	Etiketli / With Label	Çevirmeli / Turn to Release	Ø 40mm	K
B102EE	1	1	Etiketli / With Label	Çevirmeli / Turn to Release	Ø 40mm	K
B200EE	-	1	Etiketli / With Label	Çevirmeli / Turn to Release	Ø 40mm	K
B202EE	-	2	Etiketli / With Label	Çevirmeli / Turn to Release	Ø 40mm	K
B100EG	1	-	Pozisyon Göstergeli / With Position Cursor	Çevirmeli / Turn to Release	Ø 40mm	K
B102EG	1	1	Pozisyon Göstergeli / With Position Cursor	Çevirmeli / Turn to Release	Ø 40mm	K
B200EG	-	1	Pozisyon Göstergeli / With Position Cursor	Çevirmeli / Turn to Release	Ø 40mm	K
B202EG	-	2	Pozisyon Göstergeli / With Position Cursor	Çevirmeli / Turn to Release	Ø 40mm	K
B100E30	1	-		Çevirmeli / Turn to Release	Ø 30mm	K
B102E30	1	1		Çevirmeli / Turn to Release	Ø 30mm	K
B200E30	-	1		Çevirmeli / Turn to Release	Ø 30mm	K
B202E30	-	2		Çevirmeli / Turn to Release	Ø 30mm	K
B100E60	1	-		Çevirmeli / Turn to Release	Ø 60mm	K
B102E60	1	1		Çevirmeli / Turn to Release	Ø 60mm	K
B200E60	-	1		Çevirmeli / Turn to Release	Ø 60mm	K
B202E60	-	2		Çevirmeli / Turn to Release	Ø 60mm	K



B200E



B200E30



B200E60



B200EE



B200EG

Kumanda Butonları ve Sinyal Lambaları

Control Units and Pilot Lights



B Serisi Ø 22 mm Adaptörlü Kumanda Butonu Tipleri

Series Ø 22 mm Push Buttons With Adapter

Çiftli Tip Kumanda Butonları / Double Type Control Units

Ürün Kodu	Kontakt Blok Tipi	Işık	Etiket	Buton Tipi	Renk		
Code	Contact Block Type	Illumination	Button Plates	Control Unit Type	Colour		
	Normal Açık Normally Open	Normal Kapalı Normally Closed	Opsiyonel Optional				
B101K20KY	2	-	√	0-I	Çiftli / Double	Düz Kafalı / Flush	
B102K20KY	1	1	√	0-I	Çiftli / Double	Düz Kafalı / Flush	
B101K21KY	2	-	√	0-I	Çiftli / Double	Çıkık Kafalı / Single Extended	
B102K21KY	1	1	√	0-I	Çiftli / Double	Çıkık Kafalı / Single Extended	
B101K20HB	2	-	√	0-I	Çiftli / Double	Düz Kafalı / Flush	
B102K20HB	1	1	√	0-I	Çiftli / Double	Düz Kafalı / Flush	
B101K21HB	2	-	√	II-0-I	Çiftli / Double	Çıkık Kafalı / Single Extended	
B102K21HB	1	1	√	II-0-I	Çiftli / Double	1 Çıkık Kafalı / Single Extended	
B101K20HH	2	-	√	II-0-I	Çiftli / Double	Düz Kafalı / Flush	
B102K20HH	1	1	√	II-0-I	Çiftli / Double	Düz Kafalı / Flush	
B101K21HH	2	-	√	II-0-I	Çiftli / Double	Çıkık Kafalı / Single Extended	
B102K21HH	1	1	√	II-0-I	Çiftli / Double	Düz Kafalı / Flush	
B101K20SH	2	-	√	0-I	Çiftli / Double	Düz Kafalı / Flush	
B102K20SH	1	1	√	0-I	Çiftli / Double	Düz Kafalı / Flush	
B101K21SH	2	-	√	0-I	Çiftli / Double	Çıkık Kafalı / Single Extended	
B102K21SH	1	1	√	0-I	Çiftli / Double	Çıkık Kafalı / Single Extended	
B101B20KY	2	-	√	0-I	Çiftli / Double	Düz Kafalı / Flush	
B102B20KY	1	1	√	0-I	Çiftli / Double	Düz Kafalı / Flush	
B101B21KY	2	-	√	II-0-I	Çiftli / Double	Çıkık Kafalı / Single Extended	
B102B21KY	1	1	√	II-0-I	Çiftli / Double	Çıkık Kafalı / Single Extended	
B101B20HB	2	-	√	II-0-I	Çiftli / Double	Düz Kafalı / Flush	
B102B20HB	1	1	√	II-0-I	Çiftli / Double	Düz Kafalı / Flush	
B101B21HB	2	-	√	II-0-I	Çiftli / Double	Çıkık Kafalı / Single Extended	
B102B21HB	1	1	√	II-0-I	Çiftli / Double	Çıkık Kafalı / Single Extended	
B121B30BB	2	1	-		Üçüz Buton / Triple	1 Çıkık Kafalı / Single Extended	
B121B30YY	2	1	-		Üçüz Buton / Triple	1 Çıkık Kafalı / Single Extended	



B102K20KY



B102B20KY



B121B30YY



B132K21HB

- Işık Bloğu seçenekleri için bakınız sayfa 6 Kumanda Butonları Seçim Tablosu.
- See page 6 Control Units Selection table for illumination block types.
- Standart çiftli buton B102K20KY, kırmızı / yeşil ve şeffaftır.
- Standard double head control unit is B102K20KY which is red/green and transparent.
- Çiftli butonda sadece kırmızı ve siyah renkli basma düğmeleri çıkıktır.
- For double head control unit, only red and black colored buttons are extended position.

Kumanda Butonları ve Sinyal Lambaları

Control Units and Pilot Lights



Potansiyometre / Potentiometer

	Ürün Kodu Code				
	BPR01K	BPR02K	BPR05K	BPR10K	BPR100K
Empedans (R) Impedance (R)	1 kΩ	2 kΩ	5 kΩ	10 kΩ	100 kΩ
Anma Gücü (P) Rated Power (P)	Lineer 1,5W (70°C)			Lineer 1,22W (70°C)	
Koruma Sınıfı Protection Degree	IP65				
İzolasyon Direnci Isolation Resistance	min 10 MΩ (500V DC)				
Çalışma Sıcaklığı Operating Temperature	-25°C / +70°C				
Direnç Elemanı Resistive Element	Sermet / Cermet				
Elektriksel Kurs Turning Range	270° 15°				
Tolerans Tolerance	%10				
Isı Katsayısı Thermal Coefficient	%100 ppm /°C				
Dielektrik Dayanımı Dielectric Endurance	± 1750 Vrms				
Klimatik Kategori Climatic Category	55/125/56				
Maksimum Çalışma Gerilimi (V) Maximum Operating Voltage (V)	38.70	54.80	86.60	122.50	350
Maksimum Fırça Akımı (mA) Maximum Brush Current (mA)	38.70	27.4	17.30	12.20	3.5
Koruma Sınıfı Protection Degree	IP65				



BPR05K
5K Potansiyometre
5K Potentiometer

Potansiyometre / Potentiometer

Ürün Kodu Code	Özellik Features	Renk Colour
BPR01K	1 kΩ	Seramik, Telli / Ceramic, Wired
BPR02K	2 kΩ	Seramik, Telli / Ceramic, Wired
BPR05K	5 kΩ	Seramik, Telli / Ceramic, Wired
BPR10K	10 kΩ	Seramik, Telli / Ceramic, Wired
BPR100K	100 kΩ	Seramik, Telli / Ceramic, Wired

Bağlantı / Connection

Ürün Kodu Code	Özellik Features	Özellik Features
BUSB10	1 Metre / 1 Meter	USB Bağlantı / USB Connection
BRJ45	-	ETHERNET Bağlantı / ETHERNET Connection



BUSB

Kumanda Butonları ve Sinyal Lambaları

Control Units and Pilot Lights



B Serisi Ø 22 mm Adaptörlü Kumanda Butonu Tipleri

Series Ø 22 mm Push Buttons With Adapter

Sinyaller / Pilot Lights

Ürün Kodu	Işık	Nominal Gerilim	Renk
Code	Illumination	Nominal Voltage	Colour
B030X*	Ba9S Duyulu		
B050XB	LED	12 - 30V AC/DC	
B060XK	LED	12 - 30V AC/DC	
B070XM	LED	12 - 30V AC/DC	
B080XS	LED	12 - 30V AC/DC	
B090XY	LED	12 - 30V AC/DC	
B0B0XB	LED	100 - 230V AC	
B0K0XK	LED	100 - 230V AC	
B0M0XM	LED	100 - 230V AC	
B0S0XS	LED	100 - 230V AC	
B0Y0XY	LED	100 - 230V AC	



B080XS



B050XB

Kontakt Blok Tipler / Contact Block Types

Ürün Kodu	Kontakt Blok Tipi	Işık	Nominal Akım	Nominal Gerilim	Renk
Code	Contact Block Type	Illumination	Nominal Current	Nominal Voltage	Colour
	Normal Açık Normally Open				
	Normal Kapalı Normally Closed				
B1	1	-	4A	250V	-
B2	1	-	4A	250V	-
B3		Ba9S Duyulu	-	-	-
B5		LED	5-20mA	12-30V AC/DC	
B6		LED	5-20mA	12-30V AC/DC	
B7		LED	5-20mA	12-30V AC/DC	
B8		LED	5-20mA	12-30V AC/DC	
B9		LED	5-20mA	12-30V AC/DC	
BB		LED	5-15mA	100-230V AC	
BK		LED	5-15mA	100-230V AC	
BM		LED	5-15mA	100-230V AC	
BS		LED	5-15mA	100-230V AC	
BY		LED	5-15mA	100-230V AC	
BB4		LED	4-5mA	110V AC/DC	
BK4		LED	4-5mA	110V AC/DC	
BM4		LED	4-5mA	110V AC/DC	
BS4		LED	4-5mA	110V AC/DC	
BY4		LED	4-5mA	110V AC/DC	

- Max. 2W'lık Ba9S duylu Neon Ampul takılabilir.
- Assembly possibility only for Neon Lamp with max. 2W socket.
- • Maksimum 3 adet kontak blok arka arkaya eklenebilir.
- • Max. 3 contact blocks can be added subsequently.



B1



B2



B3



B9

Kumanda Butonları ve Sinyal Lambaları

Control Units and Pilot Lights



Yedekler / Spare Parts

Ürün Kodu	Tip	Pozisyon	Renk
Code	Types	Position	Colour
BDD*	Düz / Flush		B K M S Y H
BDF*	Kalıcı / Stay Put		B K M S Y H
BDH*	Çıkık / Extended		B K M S Y H
BDM*	Mantar / Mushroom		K S Y H
BDS20	Seçici / Selector	2 Pozisyonlu-Kalıcı-60° / 2 Position-Stay Put-60°	
BDS21	Seçici / Selector	2 Pozisyonlu-Dönüşlü-60° / 2 Position-Spring Return-60°	
BDS30	Seçici / Selector	3 Pozisyonlu-Kalıcı-60° / 3 Position-Stay Put-60°	
BDS31	Seçici / Selector	3 Pozisyonlu-Tek Dönüşlü-60° / 3 Position-Single Spring Return-60°	
BDS32	Seçici / Selector	3 Pozisyonlu-Çift Dönüşlü-60° / 3 Position-Double Spring Return-60°	
BDSL20*	Seçici / Selector	2 Pozisyonlu-Işıklı-Kalıcı-60° / 2 Position-Illuminated-Stay Put-60°	B K M S Y H
BDSL21*	Seçici / Selector	2 Pozisyonlu-Işıklı-Dönüşlü-60° / 2 Position-Illuminated-Spring Return-60°	B K M S Y H
BDSL30*	Seçici / Selector	3 Pozisyonlu-Işıklı-Kalıcı-60° / 3 Position-Illuminated-Stay Put-60°	B K M S Y H
BDSL31*	Seçici / Selector	3 Pozisyonlu-Işıklı-Tek Dönüşlü-60° / 3 Position-Illuminated-Single Spring Return-60°	B K M S Y H
BDSL32*	Seçici / Selector	3 Pozisyonlu-Işıklı-Çift Dönüşlü-60° / 3 Position-Illuminated-Double Spring Return-60°	B K M S Y H
BDR20	Seçici / Selector	2 Pozisyon-Kalıcı-45° / 2 Position-Stay Put-45°	
BDR21	Seçici / Selector	2 Pozisyon-Dönüşlü-45° / 2 Position-Spring Return-45°	
BDR30	Seçici / Selector	3 Pozisyon-Kalıcı-45° / 3 Position-Stay Put-45°	
BDT20	Seçici / Selector	2 Pozisyonlu-Kalıcı-90° / 2 Position-Stay Put-90°	
BDT21	Seçici / Selector	2 Pozisyonlu-Dönüşlü-90° / 2 Position-Spring Return-90°	
BDC	Mandallı / Handle Switch		H
BDAA20	Anahtarlı / Key Operated	2 Pozisyonlu, Kalıcı / 2 Position, Stay Put	
BDAA21	Anahtarlı / Key Operated	2 Pozisyonlu, Dönüşlü / 2 Position, Spring Return	
BDAA30	Anahtarlı / Key Operated	3 Pozisyonlu, Kalıcı / 3 Position, Stay Put	
BDAA31	Anahtarlı / Key Operated	3 Pozisyonlu, Tek Dönüşlü / 3 Position, Single Spring Return	
BDAA32	Anahtarlı / Key Operated	3 Pozisyonlu, Çift Dönüşlü / 3 Position, Double Spring Return	
BDAC20	Anahtarlı / Key Operated	2 Pozisyonlu, Kalıcı / 2 Position, Stay Put	
BDAC21	Anahtarlı / Key Operated	3 Pozisyonlu, Kalıcı / 3 Position, Stay Put	
BDAC30	Anahtarlı / Key Operated	3 Pozisyonlu, Kalıcı / 3 Position, Stay Put	
BDAC31	Anahtarlı / Key Operated	3 Pozisyonlu, Tek Dönüşlü / 3 Position, Single Spring Return	
BDAC32	Anahtarlı / Key Operated	3 Pozisyonlu, Çift Dönüşlü / 3 Position, Double Spring Return	
LED24*	Ba9S Duyulu LED / Ba9S LED	24V AC/DC	B K M S Y
LED220*	Ba9S Duyulu LED / Ba9S LED	220V AC	B K M S Y



BDH



BDAA20



BDS20



BDK20KY



BDSL20Y



BDE60



BDMH



BDC



LED220K



LED24S

Kumanda Butonları ve Sinyal Lambaları

Control Units and Pilot Lights



B Serisi Ø 22 mm Adaptörlü Kumanda Butonu Tipleri

Series Ø 22 mm Push Buttons With Adapter

Yedekler / Spare Parts

Ürün Kodu	Çap (mm)	Buton Tipi	Pozisyon	Renk
Code	Dia (mm)	Control Unit Types	Position	Colour
BDE	Ø 40mm	Acil Stop / Emergency Stop	Çevirmeli / Turn to Release	K
BDE30	Ø 30mm	Acil Stop / Emergency Stop	Çevirmeli / Turn to Release	K
BDE60	Ø 60mm	Acil Stop / Emergency Stop	Çevirmeli / Turn to Release	K
BDEE	Ø 40mm	Acil Stop / Emergency Stop	Etiketli - Çevirmeli / With Label - Turn to Release	K
BDEG	Ø 40mm	Acil Stop / Emergency Stop	Pozisyon-Göstergeli / With Position Cursor	K
BDK20KY		Çiftli / Double	Düz Kafalı / Flush	K Y
BDK21KY		Çiftli / Double	1 Çıkık Kafalı / Single Extended	K Y
BDK20HB		Çiftli / Double	Düz Kafalı / Flush	B H
BDK21HB		Çiftli / Double	1 Çıkık Kafalı / Single Extended	B H
BDK20HH		Çiftli / Double	Düz Kafalı / Flush	B H
BDK21HH		Çiftli / Double	1 Çıkık Kafalı / Single Extended	B H
BDK20SH		Çiftli / Double	Düz Kafalı / Flush	S H
BDK21SH		Çiftli / Double	1 Çıkık Kafalı / Single Extended	S H
BDB20KY		Çiftli / Double	Düz Kafalı / Flush	K Y
BDB21KY		Çiftli / Double	Düz Kafalı / Flush	K Y
BDB20HB		Çiftli / Double	Düz Kafalı / Flush	B K Y H
BDB21HB		Çiftli / Double	Düz Kafalı / Flush	B K Y H
BDB30BB		Üçüz Buton / Triple	Düz Kafalı / Flush	B K Y B
BDB30YY		Üçüz Buton / Triple	-	K Y Y
BDX*		Sinyal / Pilot Lights	-	B K M S Y

Özel Tampon Baskılı Butonlar / Special Pad Printed Control Units

Ürün Kodu / Code	B102K20KY-10	B101K20YY-12	B101K20YY-OK	B102K20HB-10	B101K20HH-OK	B101K20BB-12	B101K20SH-10	B101K20SS-12
Baskı / Print	I-O	I-II	Oklu / Arrow Symbol	I-O	Oklu / Arrow Symbol	I-II	I-O	I-II
Ürün Kodu / Code	B100DY-OD	B100DY-OY	B100DH-OD	B100DH-OY	B100DB-OD	B100DB-OY	B100DB-Z	B100DB-L
Baskı / Print	Dikey Oklu Vertical Arrow	Yatay Oklu Horizontal Arrow	Dikey Oklu Vertical Arrow	Yatay Oklu Horizontal Arrow	Dikey Oklu Vertical Arrow	Yatay Oklu Horizontal Arrow	Zil / Bell	Lamba / Lamp
Ürün Kodu / Code	B100DY-1	B100DY-2	B100DB-1	B100DB-2	B200DK-0	B200DH-0	B200DS-Z	B200DS-L
Baskı / Print	I	II	I	II	O	O	Zil / Bell	Lamba / Lamp

Kumanda Butonları ve Sinyal Lambaları

Control Units and Pilot Lights



Aksesuarlar / Accessories

Ürün Kodu	Tip	Özellik	Özellik	Malzeme
Code	Types	Features	Features	Material
BA	Adaptör / Adapter			Plastik / Plastic
B-ANAHTAR	Anahtar / Key			
BBUTONORTA	Kontakt Baskı Parçası / Middle Contact Activator	Düz Buton 22mm / Flush Button 22mm		
BCIFTLİROZET18	Çiftli Rozet / Double Legend Plate Holder	18mm		
BEB	Etanj Başlık / Silicon Cover	Düz Buton 22mm / Flush Button 22mm		
BEBK20	Etanj Başlık / Silicon Cover	Çiftli Butonlar / Double Buttons		
BEBK21	Etanj Başlık / Silicon Cover	1 Çıkık Kafalı-Çiftli Butonlar Single Extended-Double Buttons		
BMUHAFAZA	Emniyet Koruma / Emergency Protective Cover	Darbe Muhafaza / Stroke Protection		
BPROT	Buton Koruma / Protective Cover	Darbe Muhafaza / Stroke Protection		
BPUL	Pul / Plate	Buton Sıkıştırma / Button Tightening		
BROZET08	Rozet / Legend Plate Holder	8mm		
BROZET18	Rozet / Legend Plate Holder	18mm		
BSECICIORTA	Kontakt Baskı Parçası / Middle Contact Activator	Tek Dönümlü Seçici Buton Single Spring Return Selector Button		
BSOMAN	Somun Anahtar / Nut Tightener			
BET08	Etiket / Legend Plate	8mm	BOŞ	
BET08-01	Etiket / Legend Plate	8mm	(0-1)	
BET08-01OK	Etiket / Legend Plate	8mm	(0-1) OKLU	
BET08-12	Etiket / Legend Plate	8mm	(I-II)	
BET08-201	Etiket / Legend Plate	8mm	(2-0-1)	
BET08-201OK	Etiket / Legend Plate	8mm	(2-0-1) OKLU	
BET08-201OK2	Etiket / Legend Plate	8mm	(2-0-1) ÇİFT OKLU	
BET08-START	Etiket / Legend Plate	8mm	START	
BET08-STOP	Etiket / Legend Plate	8mm	STOP	
BET18	Etiket / Legend Plate	18mm	BOŞ	
BET18-01	Etiket / Legend Plate	18mm	(0-1)	
BET18-START	Etiket / Legend Plate	18mm	START	
BET48P	Etiket / Legend Plate	48mm	EMERGENCY	Plastik / Plastic
BET60A	Etiket / Legend Plate	60mm	ACİL STOP	Alüminyum / Aluminium
BET60LED1	Etiket-Işıklı-24V AC/DC Legend Plate-With LED-24V AC/DC	60mm	ACİL STOP-EMERGENCY	
BET60LED2	Etiket-Işıklı-24V AC/DC Legend Plate-With LED-24V AC/DC	60mm	EMERGENCY STOP EMERGENCY STOP	
BET60P	Etiket / Legend Plate	60mm	EMERGENCY STOP	Plastik / Plastic
BET60P1	Etiket / Legend Plate	60mm	ACİL DURDURMA	Plastik / Plastic
BET60P2	Etiket / Legend Plate	60mm	ARRET D'URGENCE	Plastik / Plastic
BET90A	Etiket / Legend Plate	90mm	ACİL STOP	Alüminyum / Aluminium
BET90P	Etiket / Legend Plate	90mm	ACİL STOP	Plastik / Plastic
BET90P-1	Etiket / Legend Plate	90mm	ACİL DURDURMA	Plastik / Plastic



Kumanda Butonları ve Sinyal Lambaları

Control Units and Pilot Lights



MONTAJ ŞEKLİ / ASSEMBLY

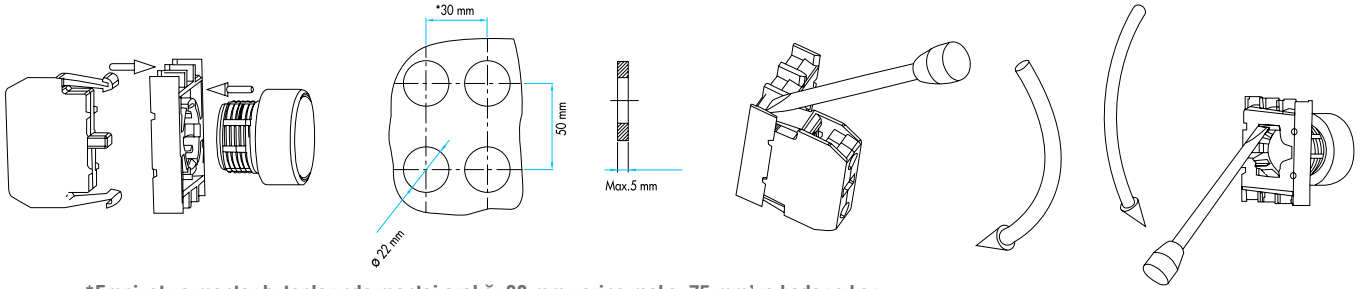

*Emniyet ve mantar butonlarında montaj aralığı 30 mm yerine maks. 75 mm'ye kadar çıkar.
The mounting distance in emergency and mushroom buttons increases up to max. 75 mm instead of 30 mm

BOYUTLAR (mm) / DIMENSIONS (mm)

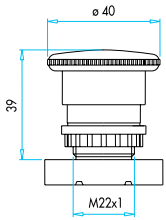

Acil Stop Ø 40 mm
Emergency Stop Ø 40 mm

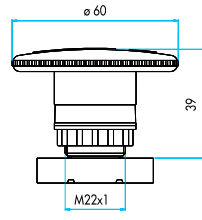

Acil Stop Ø 60 mm
Emergency Stop Ø 60 mm

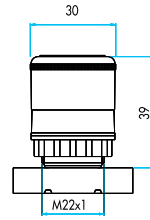

Acil Stop Ø 30 mm
Emergency Stop Ø 30 mm

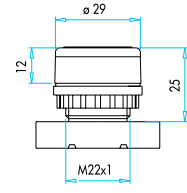

Düz
Flush

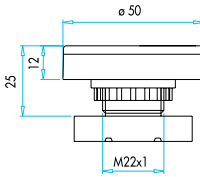

Çiftli Düz Kafalı
Double, Spring Return

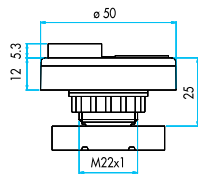

Çiftli Çıkık Kafalı
Double Extended, Spring Return

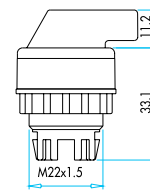

Seçici
Selector

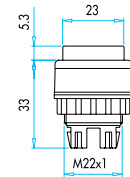

Çıkık Kafalı
Extended, Spring Return

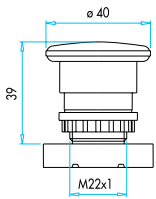

Mantar
Mushroom, Spring Return

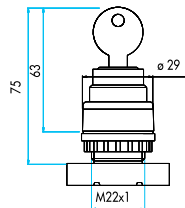

Anahtarlı
Key Operated

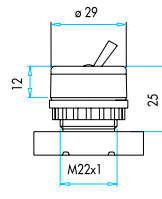

Mandallı
Handle Button

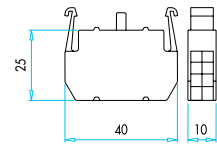

B Serisi Kontak Blok
B Series Contact Block

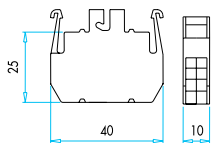

B Serisi Ampul Takılabilen Işıklı Blok
Neon Lamp Mountable
B Series Light Block

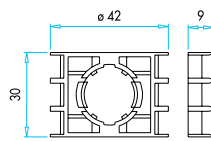

Adaptör
Adapter

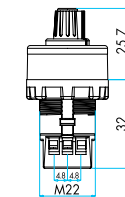

Potansiyometre
Potentiometer

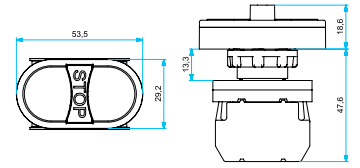

Üçüz Buton
Triple, With Extended Stop



CM Serisi Metal Ø 22mm Kumanda Buton Tipleri

- Ağır koşullara dayanıklı metal yapı, korozyona karşı krom kaplama
- Maksimum güvenlik için parmak koruma
- Darbe dayanıklı polikarbonat buton lensi
- Alev almayan V0 PA6.6 kontak bloklar
- İstenildiğinde çeşitli ışıklı kontak blokların uygunluğu
- Kolaylıkla tek elle adaptörün sökülebilmesi, adaptöre kontak blokların takılmasında alete ihtiyaç olmaması
- Led ışıkla, minimum ısınma maksimum ömür
- Arka arkaya 2 kontak blok takılabilir
- Farklı dillerde ve özel işaretli çeşitli markalama etiketleri
- Üstün silikon conta tekniği ile IP65 koruma
- Tüm uygulamalara cevap verecek ürün çeşitliliği

Teknik Bilgiler

Mekanik Ömür	: 500.000 açma-kapama min.
Elektriksel Ömür	: 100.000 açma-kapama min.
Çalışma Sıcaklığı	: min./maks. °C -5/+40
Koruma Sınıfı	: IP65
Çalışma Sıklığı	: Yüksüz 3.000 açma-kapama/saat
	: Yükte 1.200 açma-kapama/saat
Çalışma Gerilimi (Ue)	: 230 V AC
Çalışma Akımı (Ie)	: 4 A
Yalıtım Gerilimi (Ui)	: 300 V
Darbe Dayanım Gerilimi (Uimp)	: 2.5 kV
Kısa Devre Kesme Kap. (Icn)	: 1 kA
İzolasyon Direnci	: 10 MΩ min. (500 V DC)
Kullanım Sınıfı	: AC15
Dielektrik Mukavemeti	: 1.500 V AC (1dk. için)
Standart Kontak Malzemesi	: AgNi
Bağlantı Kablo Kesiti	: 1.5 - 2.5 mm ²
Standart	: UL 508 TS EN 60947-5-1 VDE0660



CM Series Metal Ø 22mm Control Units Types

- Die cast metal construction for harsh environment, corrosion-resistant chromate plating
- Finger safe protection for maximum safety
- Impact-resistant polycarbonate button lens
- Non-flammable V0 PA6.6 contact blocks
- Various illumination contact blocks availability on request
- Easy one-hand adapter removal, tools not required to attach contact blocks to adapter
- With LED illumination, minimum warm-up and maximum lifetime.
- Compact design contact blocks can be stacked by 2 blocks deep
- Various legend plates with different languages and custom markings
- IP65 protection degree with superior silicone sealing techniques
- Variety of products for all areas of application

Technical Information

Mechanical Life	: 500.000 operations min.
Electrical Life	: 100.000 operations min.
Operating Temperature	: min./max. °C -5/+40
Protection Degree	: IP65
Operating Frequency	: Without load 3.000 operations/hour
	: At full load 1.200 operations/hour
Operating Voltage (Ue)	: 230 V AC
Operating Current (Ie)	: 4 A
Insulation Voltage (Ui)	: 300 V
Impact Resistance (Uimp)	: 2.5 kV
Short Circuit Breaking Capacity (Icn)	: 1 kA
Insulation Resistance	: 10 MΩ min. (500 V DC)
Utilization Category	: AC15
Dielectric Strength	: 1.500 V AC (for 1 minute)
Standard Contact Material	: AgNi
Cable Section	: 1.5 - 2.5 mm ²
Standard	: UL 508 TS EN 60947-5-1 VDE0660



Kumanda Butonları ve Sinyal Lambaları

Control Units and Pilot Lights



CM Metal Serisi Ø 22mm Kumanda Butonları Genel Şema

CM Metal Series Ø 22mm Control Units General Scheme

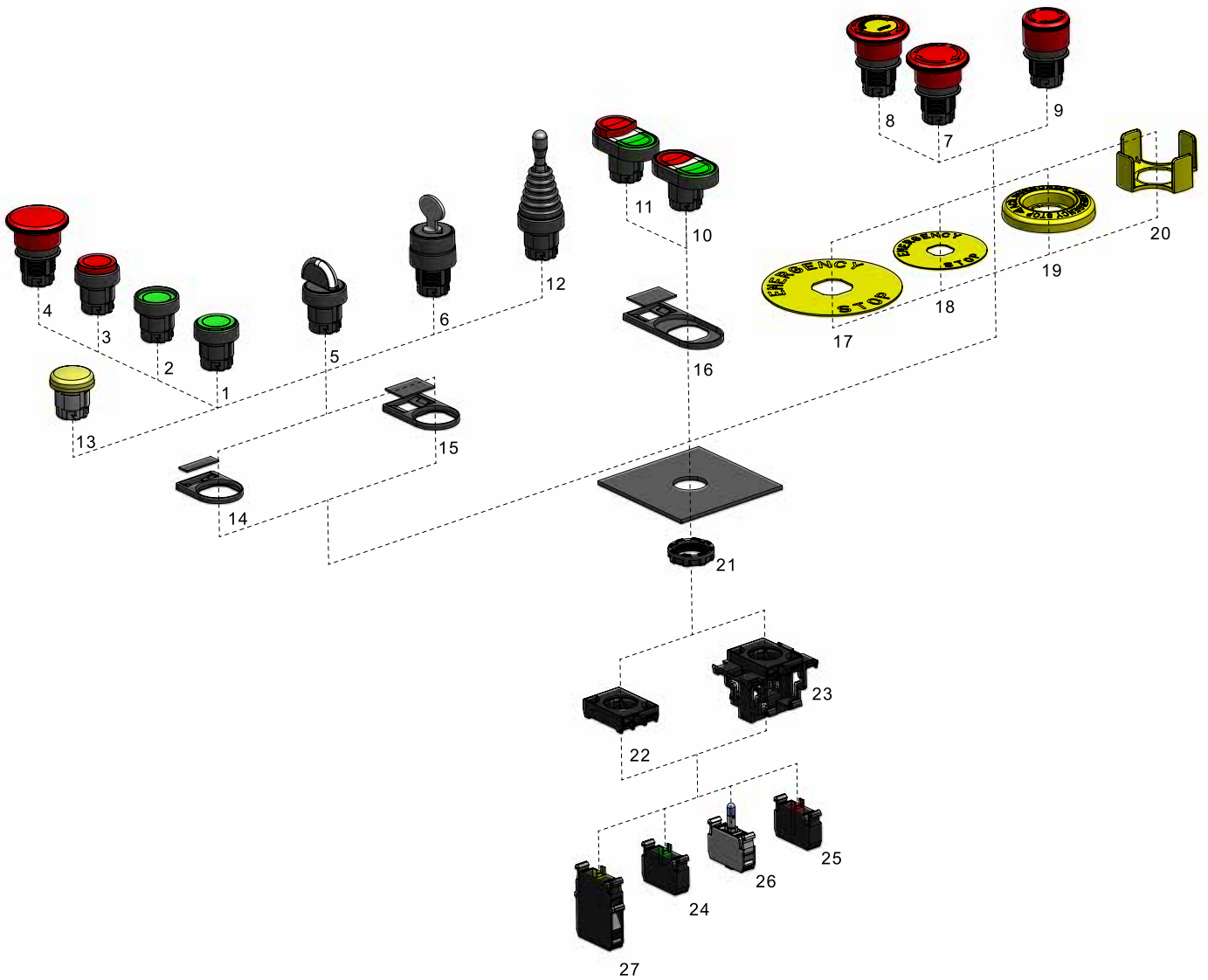

Kumanda Butonları ve Sinyal Lambaları

Control Units and Pilot Lights



	Yaylı Tip / Spring Type	
1	D	Düz / Flush
2	F	Kalıcı / Stay Put
3	H	Çıkık / Extended
4	M	Mantar, Ø 40 mm / Mushroom, Ø 40 mm
	Seçici Tip / Selector Type	
5	S	60° / 60°
	Anahtarlı Tip / Key Operated Type	
6		
	Acil Stop / Emergency Stop Type	
7	E	Ø 40mm, Çevirmeli / Ø 40mm, Turn to Release
8	EE	Ø 40mm, Etiketli, Çevirmeli / Ø 40mm, With Label, Turn to Release
9	EK30	
	Çiftli / Double	
10	K20	Düz Kafalı / Flush
11	K21	1 Çıkık kafalı / Single Extended
	Joystick Tip / Joystick	
12	DJ20	2 Pozisyonlu, Kalıcı / 2 Position, Stay Put
12	DJ21	2 Pozisyonlu, Dönüştü / 2 Position, Spring Return
12	DJ40	4 Pozisyonlu, Kalıcı / 4 Position, Stay Put
12	DJ41	4 Pozisyonlu, Dönüştü / 4 Position, Spring Return
	Sinyal / Pilots	
13	X	Yuvarlak, Sinyal / Round, Pilots
	Aksesuarlar / Accessories	
14	BROZET08	Rozet, 8mm / Legend Plate Holder, 8mm
15	BROZET18	Rozet, 18mm / Legend Plate Holder, 18mm
16	BCIFTLIROZET18	Rozet, İkiz Buton, 18mm / Legend Plate Holder, Double, 18mm
17	BET90A/P	Etiket, Ø90mm Acil Stop, Alüminyum/Plastik Legend Plate, Ø90mm Emergency Stop, Aluminium/Plastic
18	BET60A/P	Etiket, Ø60mm Acil Stop, Alüminyum/Plastik Legend Plate, Ø60mm Emergency Stop, Aluminium/Plastic
19	BET60LED	Etiket, Ø60mm Acil Stop, Led LED Illuminated Legend Plate, Ø60mm Emergency Stop
20	CMUHFAZA	Emniyet Koruma / Emergency Protective Cover
21	SOMUN	Plastic Somun, M22 X 1,5 / Plastic Nut, M22 X 1,5
22	ADAPTÖR	Adaptör / Adapter
23	EKLİ ADAPTÖR	Ek adaptör / Additional Adapter
24	START KONTAKBLOK	Kontak Blok, Start (NA) / Contact Block, Start (NO)
25	STOP KONTAKBLOK	Kontak Blok, Stop (NK) / Contact Block, Stop (NC)
26	LED KONTAKBLOK	Kontak Blok, LED / Contact Block, LED
27	JOYSTİK KONTAKBLOK	Kontak, Joystick / Contact Block, Joystick

Kumanda Butonları ve Sinyal Lambaları

Control Units and Pilot Lights



CM Serisi Kumanda Butonlar Seçim Tablosu

Series Control Units Selection Table

Seri	Kontakt Blok Kombinasyonu			Buton Tipi																																																																											
CM	1	K	2	D																																																																											
Series	Contact Block Combination			Button Type																																																																											
Seri Series CM Metal Serisi Ø 22mm Kumanda Butonları Metal Series Ø 22mm Control Units	Kontakt Blok Tipi Contact Block Type	Kontakt Blok Tipi Contact Block Type	Kontakt Blok Tipi Contact Block Type	Acil Stop Tip Emergency Stop Type																																																																											
	<table border="1"> <tr><td>0</td><td>Boş</td><td></td><td></td></tr> <tr><td>1</td><td>Start</td><td>Butonluk</td><td></td></tr> <tr><td>2</td><td>Stop</td><td>Butonluk</td><td></td></tr> <tr><td>3</td><td>Yanyana</td><td>Start</td><td>Start</td></tr> <tr><td>4</td><td>Yanyana</td><td>Start</td><td>Stop</td></tr> <tr><td>5</td><td>Yanyana</td><td>Stop</td><td>Stop</td></tr> <tr><td>6</td><td>Start</td><td>Start</td><td>Düşey</td></tr> <tr><td>7</td><td>Start</td><td>Stop</td><td>Joystick İçin</td></tr> </table>	0	Boş			1	Start	Butonluk		2	Stop	Butonluk		3	Yanyana	Start	Start	4	Yanyana	Start	Stop	5	Yanyana	Stop	Stop	6	Start	Start	Düşey	7	Start	Stop	Joystick İçin	<table border="1"> <tr><td>0</td><td>Boş</td><td></td><td></td></tr> <tr><td>1</td><td>Start</td><td>Butonluk</td><td></td></tr> <tr><td>2</td><td>Stop</td><td>Butonluk</td><td></td></tr> <tr><td>3</td><td>Yanyana</td><td>Start</td><td>Start</td></tr> <tr><td>4</td><td>Yanyana</td><td>Start</td><td>Stop</td></tr> <tr><td>5</td><td>Yanyana</td><td>Stop</td><td>Stop</td></tr> <tr><td>6</td><td>Start</td><td>Start</td><td>Düşey</td></tr> <tr><td>7</td><td>Start</td><td>Stop</td><td>Joystick İçin</td></tr> </table>	0	Boş			1	Start	Butonluk		2	Stop	Butonluk		3	Yanyana	Start	Start	4	Yanyana	Start	Stop	5	Yanyana	Stop	Stop	6	Start	Start	Düşey	7	Start	Stop	Joystick İçin	<table border="1"> <tr><td>E</td><td>Ø 40mm</td><td></td><td>Çevirmeli</td></tr> <tr><td>EE</td><td>Ø 40mm</td><td>Etiketli</td><td>Çevirmeli</td></tr> <tr><td>EK30</td><td>Ø 30mm</td><td>Kısa</td><td>Çevirmeli*</td></tr> </table>	E	Ø 40mm		Çevirmeli	EE	Ø 40mm	Etiketli	Çevirmeli	EK30	Ø 30mm	Kısa	Çevirmeli*
0	Boş																																																																														
1	Start	Butonluk																																																																													
2	Stop	Butonluk																																																																													
3	Yanyana	Start	Start																																																																												
4	Yanyana	Start	Stop																																																																												
5	Yanyana	Stop	Stop																																																																												
6	Start	Start	Düşey																																																																												
7	Start	Stop	Joystick İçin																																																																												
0	Boş																																																																														
1	Start	Butonluk																																																																													
2	Stop	Butonluk																																																																													
3	Yanyana	Start	Start																																																																												
4	Yanyana	Start	Stop																																																																												
5	Yanyana	Stop	Stop																																																																												
6	Start	Start	Düşey																																																																												
7	Start	Stop	Joystick İçin																																																																												
E	Ø 40mm		Çevirmeli																																																																												
EE	Ø 40mm	Etiketli	Çevirmeli																																																																												
EK30	Ø 30mm	Kısa	Çevirmeli*																																																																												
	Işık Bloğu Tipi Illumination Block Type			Çiftli Tip Double Type																																																																											
	<table border="1"> <tr><td>0</td><td>Boş</td><td></td><td></td></tr> <tr><td>5</td><td>12 - 30V AC/DC</td><td>Beyaz LED'li</td><td></td></tr> <tr><td>6</td><td>12 - 30V AC/DC</td><td>Kırmızı LED'li</td><td></td></tr> <tr><td>7</td><td>12 - 30V AC/DC</td><td>Mavi LED'li</td><td></td></tr> <tr><td>8</td><td>12 - 30V AC/DC</td><td>Sarı LED'li</td><td></td></tr> <tr><td>9</td><td>12 - 30V AC/DC</td><td>Yeşil LED'li</td><td></td></tr> <tr><td>B</td><td>100 - 230V AC</td><td>Beyaz LED'li</td><td></td></tr> <tr><td>K</td><td>100 - 230V AC</td><td>Kırmızı LED'li</td><td></td></tr> <tr><td>M</td><td>100 - 230V AC</td><td>Mavi LED'li</td><td></td></tr> <tr><td>S</td><td>100 - 230V AC</td><td>Sarı LED'li</td><td></td></tr> <tr><td>Y</td><td>100 - 230V AC</td><td>Yeşil LED'li</td><td></td></tr> <tr><td>Q</td><td>Özel Gerilim</td><td>Beyaz LED'li</td><td></td></tr> <tr><td>X</td><td>Özel Gerilim</td><td>Kırmızı LED'li</td><td></td></tr> <tr><td>V</td><td>Özel Gerilim</td><td>Mavi LED'li</td><td></td></tr> <tr><td>W</td><td>Özel Gerilim</td><td>Sarı LED'li</td><td></td></tr> <tr><td>Z</td><td>Özel Gerilim</td><td>Yeşil LED'li</td><td></td></tr> </table>	0	Boş			5	12 - 30V AC/DC	Beyaz LED'li		6	12 - 30V AC/DC	Kırmızı LED'li		7	12 - 30V AC/DC	Mavi LED'li		8	12 - 30V AC/DC	Sarı LED'li		9	12 - 30V AC/DC	Yeşil LED'li		B	100 - 230V AC	Beyaz LED'li		K	100 - 230V AC	Kırmızı LED'li		M	100 - 230V AC	Mavi LED'li		S	100 - 230V AC	Sarı LED'li		Y	100 - 230V AC	Yeşil LED'li		Q	Özel Gerilim	Beyaz LED'li		X	Özel Gerilim	Kırmızı LED'li		V	Özel Gerilim	Mavi LED'li		W	Özel Gerilim	Sarı LED'li		Z	Özel Gerilim	Yeşil LED'li				<table border="1"> <tr><td>K20</td><td>Düz Kafalı</td><td></td><td></td></tr> <tr><td>K21</td><td>1 Çıkık Kafalı</td><td></td><td></td></tr> </table>	K20	Düz Kafalı			K21	1 Çıkık Kafalı					
0	Boş																																																																														
5	12 - 30V AC/DC	Beyaz LED'li																																																																													
6	12 - 30V AC/DC	Kırmızı LED'li																																																																													
7	12 - 30V AC/DC	Mavi LED'li																																																																													
8	12 - 30V AC/DC	Sarı LED'li																																																																													
9	12 - 30V AC/DC	Yeşil LED'li																																																																													
B	100 - 230V AC	Beyaz LED'li																																																																													
K	100 - 230V AC	Kırmızı LED'li																																																																													
M	100 - 230V AC	Mavi LED'li																																																																													
S	100 - 230V AC	Sarı LED'li																																																																													
Y	100 - 230V AC	Yeşil LED'li																																																																													
Q	Özel Gerilim	Beyaz LED'li																																																																													
X	Özel Gerilim	Kırmızı LED'li																																																																													
V	Özel Gerilim	Mavi LED'li																																																																													
W	Özel Gerilim	Sarı LED'li																																																																													
Z	Özel Gerilim	Yeşil LED'li																																																																													
K20	Düz Kafalı																																																																														
K21	1 Çıkık Kafalı																																																																														
				Joystick Tip Joystick Type																																																																											
				<table border="1"> <tr><td>DJ20</td><td>2 Pozisyonlu</td><td>Kalıcı</td></tr> <tr><td>DJ21</td><td>2 Pozisyonlu</td><td>Dönüşlü</td></tr> <tr><td>DJ40</td><td>4 Pozisyonlu</td><td>Kalıcı</td></tr> <tr><td>DJ41</td><td>4 Pozisyonlu</td><td>Dönüşlü</td></tr> </table>	DJ20	2 Pozisyonlu	Kalıcı	DJ21	2 Pozisyonlu	Dönüşlü	DJ40	4 Pozisyonlu	Kalıcı	DJ41	4 Pozisyonlu	Dönüşlü																																																															
DJ20	2 Pozisyonlu	Kalıcı																																																																													
DJ21	2 Pozisyonlu	Dönüşlü																																																																													
DJ40	4 Pozisyonlu	Kalıcı																																																																													
DJ41	4 Pozisyonlu	Dönüşlü																																																																													
				Sinyal Pilot Lights																																																																											
				<table border="1"> <tr><td>X</td><td>Sinyal</td><td></td></tr> </table>	X	Sinyal																																																																									
X	Sinyal																																																																														

Kumanda Butonları ve Sinyal Lambaları

Control Units and Pilot Lights



Renk



Colour

Yazı



Pad Printing

Buton Tipi

Button Type

Yaylı Tip

Spring Type

D	Düz Flush
F	Kalıcı Stay Put
H	Çıkık Extended
M	Mantar \varnothing 40 mm Mushroom \varnothing 40 mm

Seçici Tip

Selector Type

S20	2 Pozisyonlu 2 Position	Kalıcı Stay Put	(0-I) (0-I)	60° 60°	↙
S21	2 Pozisyonlu 2 Position	Dönüslü Spring Return	(0-I) (0-I)	60° 60°	↗
S30	3 Pozisyonlu 3 Position	Kalıcı Stay Put	(II-0-I) (II-0-I)	60° 60°	↙
S31	3 Pozisyonlu 3 Position	Tek Dönüslü Single Spring Return	(II-0-I) (II-0-I)	60° 60°	↘
S32	3 Pozisyonlu 3 Position	Çift Dönüslü Double Spring Return	(II-0-I) (II-0-I)	60° 60°	↕

Anahtarlı Tip

Key Operated Type

AA20	2 Pozisyonlu 2 Position	0 Pozisyonunda Anahtarı Çıkan Key Removal at 0 Position	Kalıcı Stay Put	(0-I) (0-I)	60° 60°	↙
AA21	2 Pozisyonlu 2 Position	0 Pozisyonunda Anahtarı Çıkan Key Removal at 0 Position	Dönüslü Spring Return	(0-I) (0-I)	60° 60°	↗
AA30	3 Pozisyonlu 3 Position	0 Pozisyonunda Anahtarı Çıkan Key Removal at 0 Position	Kalıcı Stay Put	(II-0-I) (II-0-I)	60° 60°	↙
AA31	3 Pozisyonlu 3 Position	0 Pozisyonunda Anahtarı Çıkan Key Removal at 0 Position	Tek Dönüslü Single Spring Return	(II-0-I) (II-0-I)	60° 60°	↘
AA32	3 Pozisyonlu 3 Position	0 Pozisyonunda Anahtarı Çıkan Key Removal at 0 Position	Çift Dönüslü Double Spring Return	(II-0-I) (II-0-I)	60° 60°	↕
AC20	2 Pozisyonlu 2 Position	Tüm Pozisyonlarda Anahtarı Çıkan Key Removal at all Positions	Kalıcı Stay Put	(0-I) (0-I)	60° 60°	↙
AC30	3 Pozisyonlu 3 Position	Tüm Pozisyonlarda Anahtarı Çıkan Key Removal at all Positions	Kalıcı Stay Put	(II-0-I) (II-0-I)	60° 60°	↙
AC31	3 Pozisyonlu 3 Position	Tüm Pozisyonlarda Anahtarı Çıkan Key Removal at all Positions	Tek Dönüslü Single Spring Return	(II-0-I) (II-0-I)	60° 60°	↘
AC32	3 Pozisyonlu 3 Position	Tüm Pozisyonlarda Anahtarı Çıkan Key Removal at all Positions	Çift Dönüslü Double Spring Return	(II-0-I) (II-0-I)	60° 60°	↕

B	Beyaz White	
K	Kırmızı Red	
M	Mavi Blue	
S	Sarı Yellow	
Y	Yeşil Green	
H	Siyah Black	
BB	Beyaz White	Beyaz White
HB	Siyah Black	Beyaz White
HH	Siyah Black	Siyah Black
KY	Kırmızı Red	Yeşil Green
SS	Sarı Yellow	Sarı Yellow
YY	Yeşil Green	Yeşil Green

0	0 0	Yazılı Printed
10	I-0 I-0	Yazılı Printed
1	I I	Yazılı Printed
2	II II	Yazılı Printed
12	I-II I-II	Yazılı Printed
L	LIGHT LIGHT	Yazılı Printed
OD	OK Vertical Arrow	Dikey Yazılı Printed
OY	OK Horizontal Arrow	Yatay Yazılı Printed
OK	OK Special Arrow	Özel Yazılı Printed
OO	OK Special Arrow	Özel Yazılı Printed
S	Siren İşareti Siren Symbol	Printed
Z	Zil İşareti Siren Symbol	Printed

Örnek: CM1K2DK → Örnek olarak CM metal serisi, start-stop, 100-230 V AC/DC kırmızı ledli, kırmızı renkli, düz, yuvarlak buton seçilmiştir.

Example: CM1K2DK → CM series, start-stop, 100-230 V AC/DC with red led, red, Flush type button has been selected.

Kumanda Butonları ve Sinyal Lambaları

Control Units and Pilot Lights

EMES®

CM Metal Ø 22 mm Kumanda Buton Tipleri

Metal Ø 22 mm Control Units Types

Yaylı Tip Kumanda Butonlar / Spring Type Control Units

Ürün Kodu	Kontakt Blok Tipi		Işık	Buton Tipi	Renk
Code	Contact Block Type		Illumination	Button Type	Colour
CM100D*	1	-	✓	Düz / Flush	B K M S Y H
CM101D*	2	-	✓	Düz / Flush	B K M S Y H
CM102D*	1	1	✓	Düz / Flush	B K M S Y H
CM200D*	-	1	✓	Düz / Flush	B K M S Y H
CM202D*	-	2	✓	Düz / Flush	B K M S Y H
CM303D*	4	-	✓	Düz / Flush	B K M S Y H
CM305D*	2	2	✓	Düz / Flush	B K M S Y H
CM101F*	2	-	✓	Kalıcı / Stay Put	B K M S Y H
CM102F*	1	1	✓	Kalıcı / Stay Put	B K M S Y H
CM200F*	-	1	✓	Kalıcı / Stay Put	B K M S Y H
CM202F*	-	2	✓	Kalıcı / Stay Put	B K M S Y H
CM101H*	1	1	✓	Çıkık / Extended	B K M S Y H
CM102H*	1	1	✓	Çıkık / Extended	B K M S Y H
CM200H*	-	1	✓	Çıkık / Extended	B K M S Y H
CM202H*	-	2	✓	Çıkık / Extended	B K M S Y H
CM100M*	1	-	-	Mantar / Mushroom	K S Y H
CM101M*	2	-	-	Mantar / Mushroom	K S Y H
CM102M*	1	1	-	Mantar / Mushroom	K S Y H
CM200M*	-	1	-	Mantar / Mushroom	K S Y H
CM202M*	-	2	-	Mantar / Mushroom	K S Y H

• (*) yerine istenen rengin harfi eklenir.

• Please choose the colour and replace (*) with the letter.

• • Işık Bloğu seçenekleri için bakınız sayfa 22 Kumanda Butonları Seçim Tablosu.

• • See page 22 Control Units Selection table for illumination block types.



CM100DY



CM100HY





CM200MK

Kumanda Butonları ve Sinyal Lambaları

Control Units and Pilot Lights



Seçici Tip Kumanda Butonları / Selector Type Control Units

Ürün Kodu	Kontakt Blok Tipi	Işık	Etiket	Buton Tipi	Pozisyon	Renk	
Code	Contact Block Type	Illumination	Button Plates	Button Type	Position	Colour	
	 Normal Açık Normally Open	 Normal Kapalı Normally Closed	LED LED				
CM100S20	1	-	√	0-I	Seçici / Selector	2 Pozisyonlu-Kalıcı-60° / 2 Position-Stay Put-60°	H
CM101S20	2	-	√	0-I	Seçici / Selector	2 Pozisyonlu-Kalıcı-60° / 2 Position-Stay Put-60°	H
CM102S20	1	1	√	0-I	Seçici / Selector	2 Pozisyonlu-Kalıcı-60° / 2 Position-Stay Put-60°	H
CM100S21	1	-	√	0-I	Seçici / Selector	2 Pozisyonlu-Kalıcı-60° / 2 Position-Stay Put-60°	H
CM101S21	2	-	√	0-I	Seçici / Selector	2 Pozisyonlu-Kalıcı-60° / 2 Position-Stay Put-60°	H
CM102S21	1	1	√	0-I	Seçici / Selector	2 Pozisyonlu-Kalıcı-60° / 2 Position-Stay Put-60°	H
CM101S30	2	-	√	II-0-I	Seçici / Selector	3 Pozisyonlu-Kalıcı-60° / 3 Position-Stay Put-60°	H
CM102S30	1	1	√	II-0-I	Seçici / Selector	3 Pozisyonlu-Kalıcı-60° / 3 Position-Stay Put-60°	H
CM101S31	2	-	√	II-0-I	Seçici / Selector	3 Pozisyonlu-Tek Dönüştü-60° / 3 Position-Single Spring Return-60°	H
CM102S31	1	1	√	II-0-I	Seçici / Selector	3 Pozisyonlu-Tek Dönüştü-60° / 3 Position-Single Spring Return-60°	H
CM101S32	2	-	√	II-0-I	Seçici / Selector	3 Pozisyonlu-Çift Dönüştü -60° / 3 Position-Double Spring Return-60°	H
CM102S32	1	1	√	II-0-I	Seçici / Selector	3 Pozisyonlu-Çift Dönüştü -60° / 3 Position-Double Spring Return-60°	H

- Işık Bloğu seçenekleri için bakınız sayfa 22 Kumanda Butonları Seçim Tablosu.
- See page 22 Control Units Selection table for illumination block types.



CM100S20

Kumanda Butonları ve Sinyal Lambaları

Control Units and Pilot Lights



CM Metal Ø 22 mm Kumanda Buton Tipleri

Metal Ø 22 mm Control Units Types

Anahtarlı Tip Kumanda Butonları / Key Operated Type Control Units

Ürün Kodu	Kontakt Blok Tipi	Etiket	Tip	Pozisyon	Anahtar Çıkma Pozisyonu
Code	Contact Block Type	Button Plates	Type	Position	Key Removal Position
CM100AA20	1	-	(0-I) Kalıcı / Stay Put	2 Pozisyonlu / 2 Position	✓ 0
CM101AA20	2	-	(0-I) Kalıcı / Stay Put	2 Pozisyonlu / 2 Position	✓ 0
CM102AA20	1	1	(0-I) Kalıcı / Stay Put	2 Pozisyonlu / 2 Position	✓ 0
CM100AA21	1	-	(0-I) Dönüşlü / Spring Return	2 Pozisyonlu / 2 Position	↖ 0
CM101AA21	2	-	(0-I) Dönüşlü / Spring Return	2 Pozisyonlu / 2 Position	↖ 0
CM102AA21	1	1	(0-I) Dönüşlü / Spring Return	2 Pozisyonlu / 2 Position	↖ 0
CM101AA30	2	-	(II-0-I) Kalıcı / Stay Put	3 Pozisyonlu / 3 Position	✓ 0
CM102AA30	1	1	(II-0-I) Kalıcı / Stay Put	3 Pozisyonlu / 3 Position	✓ 0
CM101AA31	2	-	(II-0-I) Tek Dönüşlü / Single Spring Return	3 Pozisyonlu / 3 Position	↖ 0
CM102AA31	1	1	(II-0-I) Tek Dönüşlü / Single Spring Return	3 Pozisyonlu / 3 Position	↖ 0
CM101AA32	2	-	(II-0-I) Çift Dönüşlü / Double Spring Return	3 Pozisyonlu / 3 Position	↖ 0
CM101AA32	2	-	(II-0-I) Çift Dönüşlü / Double Spring Return	3 Pozisyonlu / 3 Position	↖ 0
CM100AC20	1	-	(0-I) Kalıcı / Stay Put	2 Pozisyonlu / 2 Position	✓ Tüm / All
CM101AC20	2	-	(0-I) Kalıcı / Stay Put	2 Pozisyonlu / 2 Position	✓ Tüm / All
CM102AC20	1	1	(0-I) Kalıcı / Stay Put	2 Pozisyonlu / 2 Position	✓ Tüm / All
CM100AC21	1	-	(0-I) Dönüşlü / Spring Return	2 Pozisyonlu / 2 Position	↖ Tüm / All
CM101AC21	2	-	(0-I) Dönüşlü / Spring Return	2 Pozisyonlu / 2 Position	↖ Tüm / All
CM102AC21	1	1	(0-I) Dönüşlü / Spring Return	2 Pozisyonlu / 2 Position	↖ Tüm / All
CM101AC30	2	-	(II-0-I) Kalıcı / Stay Put	3 Pozisyonlu / 3 Position	✓ Tüm / All
CM102AC30	1	1	(II-0-I) Kalıcı / Stay Put	3 Pozisyonlu / 3 Position	✓ Tüm / All
CM101AC31	2	-	(II-0-I) Tek Dönüşlü / Single Spring Return	3 Pozisyonlu / 3 Position	↖ Tüm / All
CM102AC31	1	1	(II-0-I) Tek Dönüşlü / Single Spring Return	3 Pozisyonlu / 3 Position	↖ Tüm / All
CM101AC32	2	-	(II-0-I) Çift Dönüşlü / Double Spring Return	3 Pozisyonlu / 3 Position	↖ Tüm / All
CM101AC32	2	-	(II-0-I) Çift Dönüşlü / Double Spring Return	3 Pozisyonlu / 3 Position	↖ Tüm / All



CM100AC20

Kumanda Butonları ve Sinyal Lambaları

Control Units and Pilot Lights



Acil Stop Tip Kumanda Butonları / Emergency Stop Type Control Units

Ürün Kodu	Kontakt Blok Tipi	Etiket	Tip	Çap (mm)	Renk
Code	Contact Block Type	Button Plates	Type	Dia (mm)	Colour
	 Normal Açık Normally Open	 Normal Kapalı Normally Closed			
CM100E	1	-	Çevirmeli / Turn to Release	Ø 40mm	K S
CM102E	1	1	Çevirmeli / Turn to Release	Ø 40mm	K S
CM200E	-	1	Çevirmeli / Turn to Release	Ø 40mm	K S
CM202E	-	2	Çevirmeli / Turn to Release	Ø 40mm	K S
CM100EE	1	-	Etiketli - Çevirmeli / With Label - Turn to Release	Ø 40mm	K
CM102EE	1	1	Etiketli - Çevirmeli / With Label - Turn to Release	Ø 40mm	K
CM200EE	-	1	Etiketli - Çevirmeli / With Label - Turn to Release	Ø 40mm	K
CM202EE	-	2	Etiketli - Çevirmeli / With Label - Turn to Release	Ø 40mm	K
CM100EK30	1	-	Çevirmeli Kısa / Turn to Release	Ø 30mm	K
CM102EK30	1	1	Çevirmeli Kısa / Turn to Release	Ø 30mm	K
CM200EK30	-	1	Çevirmeli Kısa / Turn to Release	Ø 30mm	K
CM202EK30	-	2	Çevirmeli Kısa / Turn to Release	Ø 30mm	K





CM200E



CM200EE

Çiftli Tip Kumanda Butonları / Double Type Control Units

Ürün Kodu	Kontakt Blok Tipi	Işık	Buton Tipi	Renk		
Code	Contact Block Type	Illumination	Control Unit Type	Colour		
	 Normal Açık Normally Open	 Normal Kapalı Normally Closed	Opsiyonel Optional			
CM102K20HB	1	1	✓	Çiftli / Double	Düz Kafalı / Flush	B H
CM102K20HS	1	1	✓	Çiftli / Double	Düz Kafalı / Flush	S H
CM102K20KY	1	1	✓	Çiftli / Double	Düz Kafalı / Flush	K Y
CM102K21HB	1	1	✓	Çiftli / Double	1 Çıkık Kafalı / Single Extended	B H
CM102K21KY	1	1	✓	Çiftli / Double	1 Çıkık Kafalı / Single Extended	K Y

• Işık Bloğu seçenekleri için bakınız sayfa 22 Kumanda Butonları Seçim Tablosu.

• See page 22 Control Units Selection table for illumination block types.

• Standart çiftli buton B102K20KY, kırmızı / yeşil ve şeffaftır.

• Standard double head control unit is B102K20KY which is red/green and transparent.

••• Çiftli butonda sadece kırmızı ve siyah renkli basma düğmeleri çıkıktır.

••• For double head control unit, only red and black colored buttons are extended position.



CM102K20KY

Kumanda Butonları ve Sinyal Lambaları



Control Units and Pilot Lights



CM Metal Ø 22 mm Kumanda Buton Tipleri

Metal Ø 22 mm Control Units Types

Joystick Tip Kumanda Butonları / Joystick Type Control Units

Ürün Kodu	Kontakt Blok Tipi	Etiket	Tip	Pozisyon	Renk
Code	Contact Block Type	Button Plates	Type	Position	Colour
					
CM101DJ20	2	-	Kalıcı / Stay Put	2 Pozisyonlu / 2 Position	H
CM101DJ21	2	-	Dönüşlü / Spring Return	2 Pozisyonlu / 2 Position	H
CM102DJ21	1	-	Dönüşlü / Spring Return	2 Pozisyonlu / 2 Position	H
CM707DJ40	4	-	Kalıcı / Stay Put	2 Pozisyonlu / 2 Position	H
CM707DJ41	4	-	Dönüşlü / Spring Return	2 Pozisyonlu / 2 Position	H



CM707DJ40



CM101DJ20

Sinyaller / Pilot Lights

Ürün Kodu	Işık	Ürün Kodu	Nominal Gerilim	Renk
Code	Illumination	Nominal Voltage	Colour	
CM050XB	LED	12 - 30V AC/DC	B	
CM060XK	LED	12 - 30V AC/DC	K	
CM070XM	LED	12 - 30V AC/DC	M	
CM080XS	LED	12 - 30V AC/DC	S	
CM090XY	LED	12 - 30V AC/DC	Y	
CM0B0XB	LED	100 - 230V AC	B	
CM0K0XK	LED	100 - 230V AC	K	
CM0M0XM	LED	100 - 230V AC	M	
CM0S0XS	LED	100 - 230V AC	S	
CM0Y0XY	LED	100 - 230V AC	Y	



CM090XY



CM050XB



CM0B0XB



CM0M0XM



CM0S0XS

Kumanda Butonları ve Sinyal Lambaları

Control Units and Pilot Lights



Kontakt Blok Tipler / Contact Block Types

Ürün Kodu	Kontakt Blok Tipi	İşık	Nominal Akım	Nominal Gerilim	Kullanım Yeri	Özellik	Renk
Code	Contact Block Type	Illumination	Nominal Current	Nominal Voltage	Place of Use	Features	Colour
	 Normal Açık Normally Open	 Normal Kapalı Normally Closed					
C1	1	-	4A	230V	Butonluk / For Control Units		
C1AU	1	-	4A	230V	Butonluk -Altın Kaplamalı For Control Units-Gold Plated	Altın Kaplama / Gold Plated	
C2	-	1	4A	230V	Butonluk / For Control Units		
C2AU	-	1	4A	230V	Butonluk -Altın Kaplamalı For Control Units-Gold Plated	Altın Kaplama / Gold Plated	
C12	2	-	4A	230V	Joystick- Butonluk Joystick For Control Units		
CB5		LED	5-20mA	12-30V AC/DC	Butonluk / For Control Units		B
CB6		LED	5-20mA	12-30V AC/DC	Butonluk / For Control Units		K
CB7		LED	5-20mA	12-30V AC/DC	Butonluk / For Control Units		M
CB8		LED	5-20mA	12-30V AC/DC	Butonluk / For Control Units		S
CB9		LED	5-20mA	12-30V AC/DC	Butonluk / For Control Units		Y
CBB		LED	5-15mA	100-230V AC	Butonluk / For Control Units		B
CBK		LED	5-15mA	100-230V AC	Butonluk / For Control Units		K
CBM		LED	5-15mA	100-230V AC	Butonluk / For Control Units		M
CBS		LED	5-15mA	100-230V AC	Butonluk / For Control Units		S
CBY		LED	5-15mA	100-230V AC	Butonluk / For Control Units		Y
CBB4		LED	4-5mA	110V AC/DC	Butonluk / For Control Units		B
CBK4		LED	4-5mA	110V AC/DC	Butonluk / For Control Units		K
CBM4		LED	4-5mA	110V AC/DC	Butonluk / For Control Units		M
CBS4		LED	4-5mA	110V AC/DC	Butonluk / For Control Units		S
CBY4		LED	4-5mA	110V AC/DC	Butonluk / For Control Units		Y

• Maksimum 2 adet kontak blok arka arkaya eklenebilir.

• Max. 2 contact blocks can be added subsequently.

•• C1AU, C2AU Altın kaplamalı kontak blok.

•• C1AU, C2AU gold plated contact block.

••• C12, Joystick kontak blok.

••• C12, Joystick contact block.



C1



C2



CBB

Kumanda Butonları ve Sinyal Lambaları

Control Units and Pilot Lights



CM Metal Ø 22 mm Kumanda Buton Tipleri

Metal Ø 22 mm Control Units Types

Yedekler / Spare Parts

Ürün Kodu Code	Buton Tipi Control Unit Types	Pozisyon Position	Renk Colour
CMDD*	Düz / Flush		
CMDF*	Kalıcı / Stay, Put		
CMDH*	Çıkık / Extended		
CMDM*	Mantar / Mushroom		
CMDS20	Seçici / Selector	2 Pozisyonlu-Kalıcı-60° / 2 Position-Stay Put-60°	
CMDS21	Seçici / Selector	2 Pozisyonlu-Dönüşlü-60° / 2 Position-Spring Return-60°	
CMDS30	Seçici / Selector	3 Pozisyonlu-Kalıcı -60° / 3 Position-Stay Put-60°	
CMDS31	Seçici / Selector	3 Pozisyonlu-Tek Dönüşlü-60° / 3 Position-Single Spring Return-60°	
CMDS32	Seçici / Selector	3 Pozisyonlu-Çift Dönüşlü -60° / 3 Position-Double Spring Return-60°	
CMDAA20	Anahtarlı / Key Operated	2 Pozisyonlu, Kalıcı / 2 Position, Stay Put	
CMDAA21	Anahtarlı / Key Operated	2 Pozisyonlu-Dönüşlü / 2 Position-Spring Return	
CMDAA30	Anahtarlı / Key Operated	3 Pozisyonlu-Kalıcı / 3 Position-Stay Put	
CMDAA31	Anahtarlı / Key Operated	3 Pozisyonlu-Tek Dönüşlü / 3 Position-Single Spring Return	
CMDAC20	Anahtarlı / Key Operated	2 Pozisyonlu, Kalıcı / 2 Position, Stay Put	
CMDAC21	Anahtarlı / Key Operated	2 Pozisyonlu-Dönüşlü / 2 Position-Spring Return	
CMDAC30	Anahtarlı / Key Operated	3 Pozisyonlu-Kalıcı / 3 Position-Stay Put	
CMDAC31	Anahtarlı / Key Operated	3 Pozisyonlu-Tek Dönüşlü / 3 Position-Single Spring Return	
CMDAC32	Anahtarlı / Key Operated	3 Pozisyonlu-Çift Dönüşlü / 3 Position-Double Spring Return	
CMDK20HB	Çiftli / Double	Düz Kafalı / Flush	
CMDK20KY	Çiftli / Double	Düz Kafalı / Flush	
CMDK21HB	Çiftli / Double	1 Çıkık Kafalı / Single Extended	
CMDK21KY	Çiftli / Double	1 Çıkık Kafalı / Single Extended	
CMDJ20	Joystick	2 Pozisyonlu-Kalıcı / 2 Position-Stay Put	
CMDJ21	Joystick	2 Pozisyonlu-Dönüşlü / 2 Position-Spring Return	
CMDJ40	Joystick	4 Pozisyonlu-Kalıcı / 4 Position-Stay Put	
CMDJ41	Joystick	4 Pozisyonlu-Dönüşlü / 4 Position-Spring Return	
CMDX*	Sinyal / Pilot Lights		

Özel Tampon Baskılı Butonlar / Special Pad Printed Control Units

Ürün Kodu / Code	CM102K20KY-10	CM101K20YY-12	CM101K20YY-OK	CM102K20HB-10	CM101K20HH-OK	CM101K20BB-12	CM101K20SH-10	CM101K20SS-12
Baskı / Print	I-O	I-II	Oklu / Arrow Symbol	I-O	Oklu / Arrow Symbol	I-II	I-O	I-II
Ürün Kodu / Code	CM100DY-OD	CM100DY-OY	CM100DH-OD	CM100DH-OY	CM100DB-OD	CM100DB-OY	CM100DB-Z	CM100DB-L
Baskı / Print	Dikey Oklu Vertical Arrow	Yatay Oklu Horizontal Arrow	Dikey Oklu Vertical Arrow	Yatay Oklu Horizontal Arrow	Dikey Oklu Vertical Arrow	Yatay Oklu Horizontal Arrow	Zil / Bell	Lamba / Lamp
Ürün Kodu / Code	CM100DY-1	CM100DY-2	CM100DB-1	CM100DB-2	CM200DK-O	CM200DH-O	CM200DS-Z	CM200DS-L
Baskı / Print	I	II	I	II	O	O	Zil / Bell	Lamba / Lamp

Not: Minimum Sipariş miktarı 50 Adettir.
Note : Minimum Order Quantity : 50 pcs

Kumanda Butonları ve Sinyal Lambaları

Control Units and Pilot Lights



Aksesuarlar / Accessories

Ürün Kodu Code	Tip Types	Özellik Features	Etiket Button Plates	Malzeme Material
BCIFTLİROZET18	Çiftli Rozet / Double Legend Plate Holder	18mm		
BEB	Etanj Başlık / Silicon Cover	Düz Buton 22mm / Flush Button 22mm		
BEBK20	Etanj Başlık / Silicon Cover	Çiftli Butonlar / Double Buttons		
BEBK21	Etanj Başlık / Silicon Cover	1 Çıkık Kafalı-Çiftli Butonlar Single Extended -Double Buttons		
BMUHFAZA	Emniyet Koruma / Emergency Protective Cover	Darbe Muhafaza / Stroke Protection		
BPROT	Buton Koruma / Protective Cover	Darbe Muhafaza / Stroke Protection		
BPUL	Pul / Plate	Buton Sıkıştırma / Button Tightening		
BROZET08	Rozet / Legend Plate Holder	8mm		
BROZET18	Rozet / Legend Plate Holder	18mm		
BSOMAN	Somun Anahtarları / Nut Tightener			
BET08	Etiket / Legend Plate	8mm	BOŞ	
BET08-01	Etiket / Legend Plate	8mm	(0-1)	
BET08-01OK	Etiket / Legend Plate	8mm	(0-1) OKLU	
BET08-12	Etiket / Legend Plate	8mm	(I-II)	
BET08-201	Etiket / Legend Plate	8mm	(2-0-1)	
BET08-201OK	Etiket / Legend Plate	8mm	(2-0-1) OKLU	
BET08-201OK2	Etiket / Legend Plate	8mm	(2-0-1) ÇİFT OKLU	
BET08-START	Etiket / Legend Plate	8mm	START	
BET08-STOP	Etiket / Legend Plate	8mm	STOP	
BET18	Etiket / Legend Plate	18mm	BOŞ	
BET18-01	Etiket / Legend Plate	18mm	(0-1)	
BET18-START	Etiket / Legend Plate	18mm	START	
BET48P	Etiket / Legend Plate	48mm	EMERGENCY	Plastik / Plastic
BET60A	Etiket / Legend Plate	60mm	ACİL STOP	Alüminyum / Aluminium
BET60LED1	Etiket-Işıkli-24V AC/DC Plate-With LED-24V AC/DC	60mm	ACİL STOP- EMERGENCY	
BET60LED2	Etiket-Işıkli-24V AC/DC Plate-With LED-24V AC/DC	60mm	EMERGENCY STOP - EMERGENCY STOP	
BET60P	Etiket / Legend Plate	60mm	EMERGENCY STOP	Plastik / Plastic
BET60P1	Etiket / Legend Plate	60mm	ACİL DURDURMA	Plastik / Plastic
BET60P2	Etiket / Legend Plate	60mm	ARRET D'URGENCE	Plastik / Plastic
BET90A	Etiket / Legend Plate	90mm	ACİL STOP	Alüminyum / Aluminium
BET90P	Etiket / Legend Plate	90mm	ACİL STOP	Plastik / Plastic
BET90P-1	Etiket / Legend Plate	90mm	ACİL DURDURMA	Plastik / Plastic



BROZET18



BROZET08



BET60LED1



BET60LED2



BET60P



BPUL



BPROT



BMUHFAZA

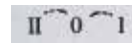

BET08-201OK2



BET08-201OK



BET08



BET18



BET08-START

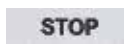

BET08-STOP



BET08-01



BET08-01OK



BET08-201

MONTAJ ŞEKLİ / ASSEMBLY

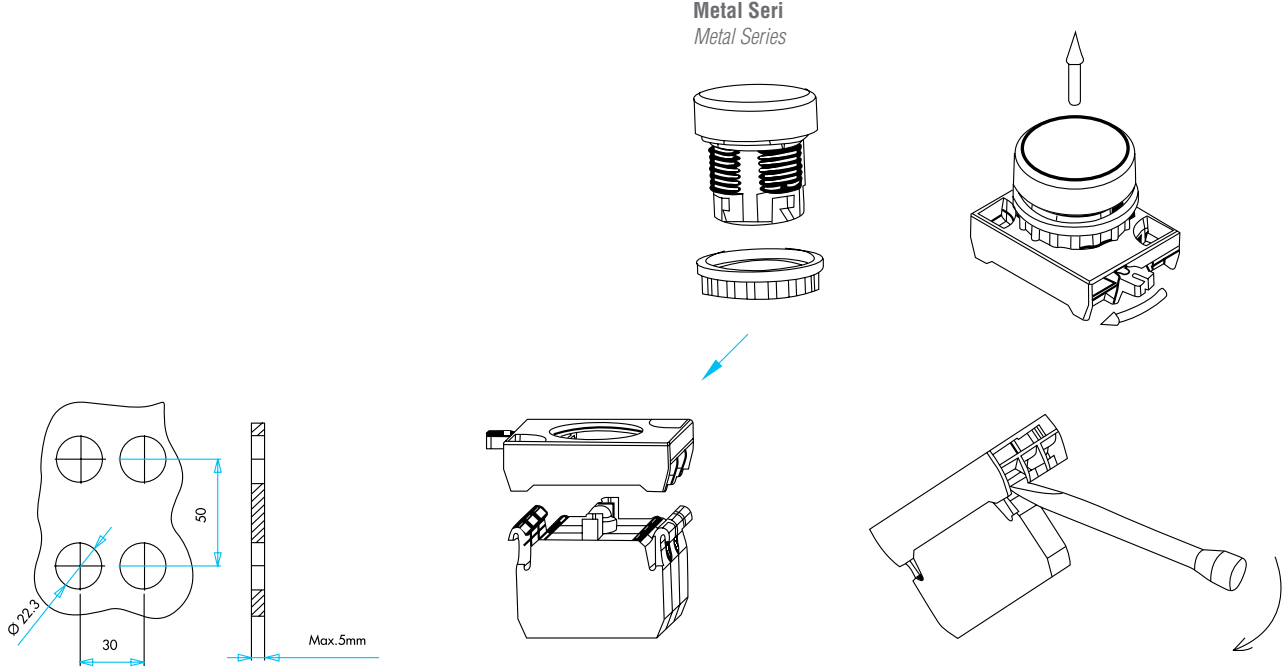

Emniyet ve mantar butonlarında 30 mm ölçüsü 45 mm'dir.
30 mm size is 45 mm in emergency and mushroom buttons.

BOYUTLAR (mm) / DIMENSIONS (mm)

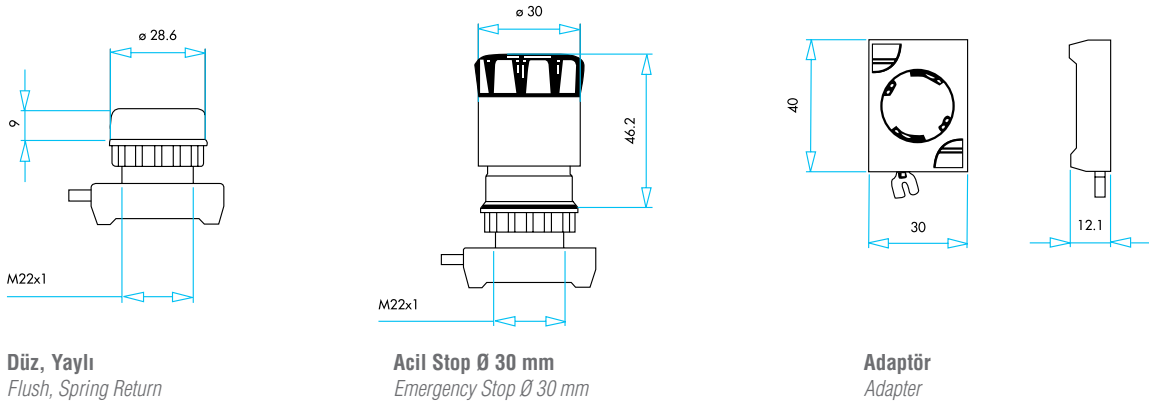



CP Serisi Plastik Ø 22mm Kumanda Buton Tipleri

- Maksimum güvenlik için parmak koruma
- Darbe dayanıklı polikarbonat buton lensi
- Alev almayan V0 PA6.6 kontak bloklar
- İstenildiğinde çeşitli ışıklı kontak blokların uygunluğu
- Kolaylıkla tek elle adaptörün sökülebilmesi, adaptöre kontak blokların takılmasında alete ihtiyaç olmaması
- Led ışıkla, minimum ısınma maksimum ömür
- Arka arkaya 2 kontak blok takılabilir
- Farklı dillerde ve özel işaretli çeşitli markalama etiketleri
- Üstün silikon conta tekniği ile IP65 koruma
- Tüm uygulamalara cevap verecek ürün çeşitliliği

Teknik Bilgiler

Mekanik Ömür	: 500.000 açma-kapama min.
Elektriksel Ömür	: 100.000 açma-kapama min.
Çalışma Sıcaklığı	: min./maks. °C -5/+40
Koruma Sınıfı	: IP65
Çalışma Sıklığı	: Yüksüz 3.000 açma-kapama/saat
	: Yükte 1.200 açma-kapama/saat
Çalışma Gerilimi (Ue)	: 230 V AC
Çalışma Akımı (Ie)	: 4 A
Yalıtım Gerilimi (Ui)	: 300 V
Darbe Dayanım Gerilimi (Uimp)	: 2.5 kV
Kısa Devre Kesme Kap. (Icn)	: 1 kA
İzolasyon Direnci	: 10 MΩ min. (500 V DC)
Kullanım Sınıfı	: AC15
Dielektrik Mukavemeti	: 1.500 V AC (1 dk. için)
Standart Kontak Malzemesi	: AgNi
Bağlantı Kablo Kesiti	: 1.5 - 2.5 mm ²
Standart	: UL 508 TS EN 60947-5-1 VDE0660



CP Series Plastic Ø 22mm Control Units Types

- Finger safe protection for maximum safety
- Impact-resistant polycarbonate button lens
- Non-flammable V0 PA6.6 contact blocks
- Various illumination contact blocks availability on request
- Easy one-hand adapter removal, tools not required to attach contact blocks to adapter
- With LED illumination, minimum warm-up and maximum lifetime
- Compact design contact blocks can be stacked by 2 blocks deep
- Various legend plates with different languages and custom markings
- IP65 protection degree with superior silicone sealing techniques
- Variety of products for all areas of application

Technical Information

Mechanical Life	: 500.000 operations min.
Electrical Life	: 100.000 operations min.
Operating Temperature	: min./max. °C -5/+40
Protection Degree	: IP65
Operating Frequency	: Without load 3.000 operations/hour
	: At full load 1.200 operations/hour
Operating Voltage (Ue)	: 230 V AC
Operating Current (Ie)	: 4 A
Insulation Voltage (Ui)	: 300 V
Impact Resistance (Uimp)	: 2.5 kV
Short Circuit Breaking Capacity (Icn)	: 1 kA
Insulation Resistance	: 10 MΩ min. (500 V DC)
Utilization Category	: AC15
Dielectric Strength	: 1.500 V AC (For 1 minute)
Standard Contact Material	: AgNi
Cable Section	: 1.5 - 2.5 mm ²
Standard	: UL 508 TS EN 60947-5-1 VDE0660



Kumanda Butonları ve Sinyal Lambaları Control Units and Pilot Lights



CP Plastik Serisi Ø 22mm Kumanda Butonları Genel Şema CP Plastic Series Ø 22mm Control Units General Scheme

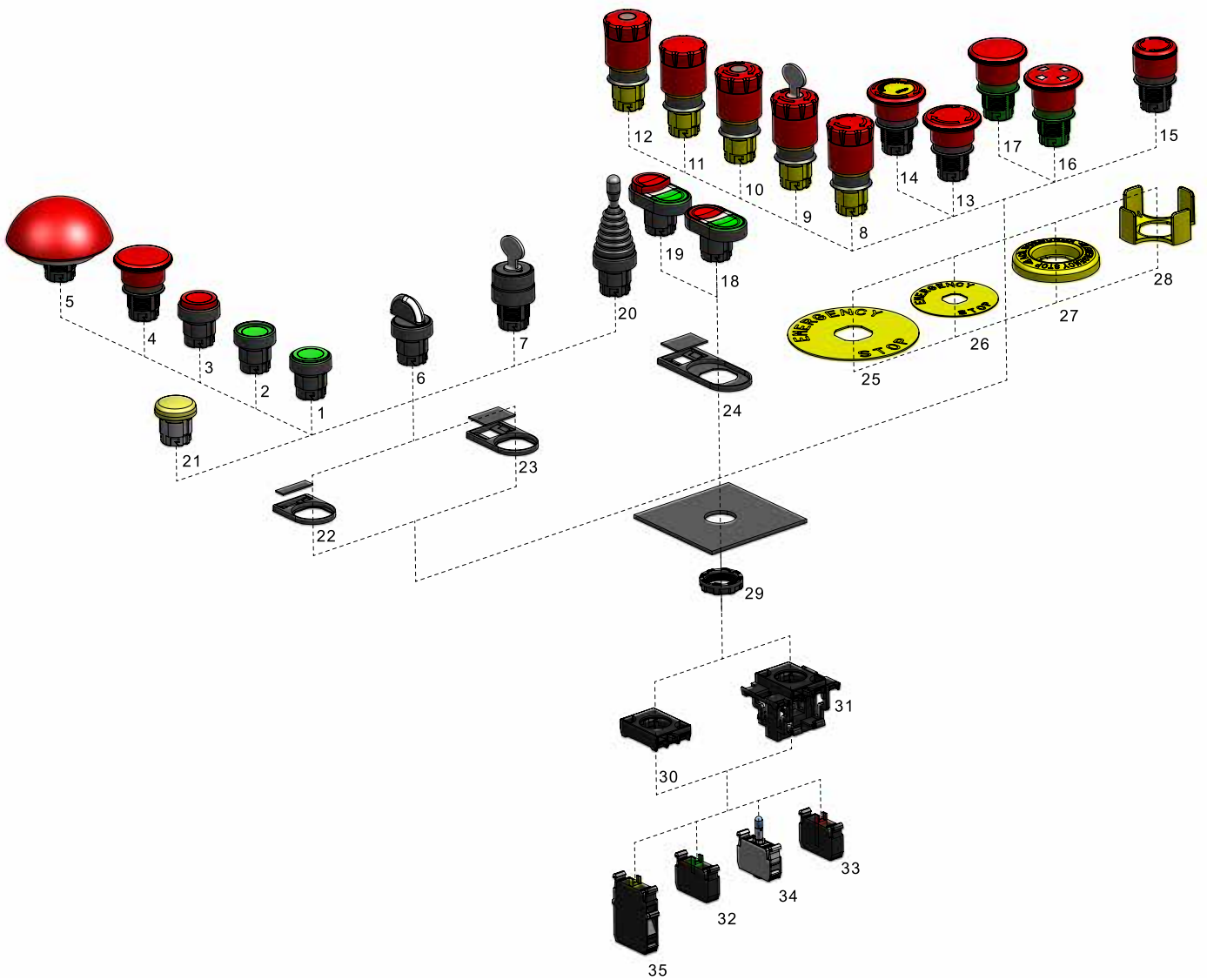

Kumanda Butonları ve Sinyal Lambaları

Control Units and Pilot Lights



Yaylı Tip / Spring Type		
1	D	Düz / Flush
2	F	Kalıcı / Stay Put
3	H	Çıkık / Extended
4	M	Mantar, Ø 40 mm / Mushroom, Ø 40 mm
5	M72	Mantar, Ø 72 mm / Mushroom, Ø 72 mm
Seçici Tip / Selector Type		
6	S	60° / 60°
Anahtarlı Tip / Key Operated Type		
7	A	
Acil Stop / Emergency Stop Type		
8	E30	Ø 30mm, Çevirmeli / Ø 30mm, Turn to Release
9	EA30	Ø 30mm, Anahtarlı, Çevirmeli / Ø 30mm, Key Operated, Turn to Release
10	ES30	Ø 30mm, Sinyalli, Çevirmeli / Ø 30mm, With Signal, Turn to Release
11	ECN30	Ø 30mm, Çekmeli / Ø 30mm, Pull to Release
12	ECS30	Ø 30mm, Sinyalli, Çekmeli / Ø 30mm, With Signal, Pull to Release
13	E	Ø 40mm, Çevirmeli / Ø 40mm, Turn to Release
14	EE	Ø 40mm, Etiketli, Çevirmeli / Ø 40mm, With Label, Turn to Release
15	EK30	Ø 30mm, Kısa, Çevirmeli / Ø 30mm, Short, Turn to Release
16	EP	Ø 40mm, Pencere, Çekmeli / Ø 40mm, With Window, Pull to Release
17	EC	Ø 40mm, Çekmeli / Ø 40mm, Pull to Release
Çiftli / Double		
18	K20	Düz Kafalı / Flush
19	K21	1 Çıkık Kafalı / Single Extended
Joystik Tip / Joystick		
20	DJ20	2 Pozisyonlu, Kalıcı / 2 Position, Stay Put
20	DJ21	2 Pozisyonlu, Dönüştü / 2 Position, Spring Return
20	DJ40	4 Pozisyonlu, Kalıcı / 4 Position, Stay Put
20	DJ41	4 Pozisyonlu, Dönüştü / 4 Position, Spring Return
Sinyal / Pilots		
21	X	Yuvarlak, Sinyal / Round, Pilots
Aksesuarlar / Accessories		
22	BROZET08	Rozet, 8mm / Legend Plate Holder, 8mm
23	BROZET18	Rozet, 18mm / Legend Plate Holder, 18mm
24	BCIFTLIROZET18	Rozet, İkiz Buton, 18mm / Legend Plate Holder, Double, 18mm
25	BET90A/P	Etiket, Ø90mm Acil Stop, Alüminyum / Plastik / Legend Plate, Ø90mm Emergency Stop, Aluminium / Plastic
26	BET60A/P	Etiket, Ø60mm Acil Stop, Alüminyum / Plastik / Legend Plate, Ø60mm Emergency Stop, Aluminium / Plastic
27	BET60LED	Etiket, Ø60mm Acil Stop, LED / LED Illuminated Legend Plate, Ø60mm Emergency Stop
28	CMUHAFAZA	Emniyet Koruma / Emergency Protective Cover
29	SOMUN	Plastic Somun, M22 X 1,5 / Plastic Nut, M22 X 1,5
30	ADAPTÖR	Adaptör / Adapter
31	EKLİ ADAPTÖR	Ek Adaptör / Additional Adapter
32	START KONTAKBLOK	Kontakt Blok, Start (NA) / Contact Block, Start (NO)
33	STOP KONTAKBLOK	Kontakt Blok, Stop (NK) / Contact Block, Stop (NC)
34	LED KONTAKBLOK	Kontakt Blok, LED / Contact Block, LED
35	JOYSTIK KONTAKBLOK	Kontakt, Joystik / Contact Block, Joystick

Kumanda Butonları ve Sinyal Lambaları

Control Units and Pilot Lights



CP Serisi Kumanda Butonlar Seçim Tablosu

Series Control Units Selection Table

Seri	Kontakt Blok Kombinasyonu			Buton Tipi
CP	1	K	2	D
Series	Contact Block Combination			Button Type
Seri Series CP Plastik Serisi Ø 22mm Kumanda Butonları Plastic Series Ø 22mm Control Units	Kontakt Blok Tipi Contact Block Type 0 Boş Empty 1 Start Start 2 Stop Stop 3 Yanyana Tandem 4 Yanyana Tandem 5 Yanyana Tandem 6 Start Start 7 Start Start Butonluk For Button Butonluk For Button Start Start Start Start Stop Stop Stop Stop Start Start Start Start Düşey Back to Back Joystick İçin For Joystick	Kontakt Blok Tipi Contact Block Type 0 Boş Empty 1 Start Start 2 Stop Stop 3 Yanyana Tandem 4 Yanyana Tandem 5 Yanyana Tandem 6 Start Start 7 Start Start Butonluk For Button Butonluk For Button Start Start Start Start Stop Stop Stop Stop Start Start Start Start Düşey Back to Back Joystick İçin For Joystick	Acil Stop Tipi Emergency Stop Type E Ø 40mm Ø 40mm E30 Ø 30mm Ø 30mm EA30 Ø 30mm Ø 30mm ECN30 Ø 30mm Ø 30mm ECS30 Ø 30mm Ø 30mm EE Ø 40mm Ø 40mm EK30 Ø 30mm Ø 30mm EP Ø 40mm Ø 40mm ES30 Ø 30mm Ø 30mm EC Ø 40mm Ø 40mm Çevirmeli Turn to Release Çevirmeli Turn to Release Çevirmeli* Turn to Release Çekmeli* Pull to Release Çekmeli* Pull to Release Çekmeli* Pull to Release Çevirmeli Turn to Release Çevirmeli* Turn to Release Çekmeli Pull to Release Çevirmeli* Turn to Release Çekmeli* Pull to Release Çiftli Tip Double Type K20 Düz Kafalı Flush K21 1 Çıkık Kafalı Single Extended Joystick Tipi Joystick Type DJ20 2 Pozisyonlu 2 Position DJ21 2 Pozisyonlu 2 Position DJ40 4 Pozisyonlu 4 Position DJ41 4 Pozisyonlu 4 Position Sinyal Pilot Lights X Sinyal Pilot Lights	İşık Bloğu Tipi Illumination Block Type 0 Boş Without Illumination 5 12 - 30V AC/DC 12 - 30V AC/DC 6 12 - 30V AC/DC 12 - 30V AC/DC 7 12 - 30V AC/DC 12 - 30V AC/DC 8 12 - 30V AC/DC 12 - 30V AC/DC 9 12 - 30V AC/DC 12 - 30V AC/DC B 100 - 230V AC 100 - 230V AC K 100 - 230V AC 100 - 230V AC M 100 - 230V AC 100 - 230V AC S 100 - 230V AC 100 - 230V AC Y 100 - 230V AC 100 - 230V AC Q Özel Gerilim Special Voltage X Özel Gerilim Special Voltage V Özel Gerilim Special Voltage W Özel Gerilim Special Voltage Z Özel Gerilim Special Voltage Beyaz LED'li With White LED Kırmızı LED'li With Red LED Mavi LED'li With Blue LED Sarı LED'li With Yellow LED Yeşil LED'li With Green LED Beyaz LED'li With White LED Kırmızı LED'li With Red LED Mavi LED'li With Blue LED Sarı LED'li With Yellow LED Yeşil LED'li With Green LED Beyaz LED'li With White LED Kırmızı LED'li With Red LED Mavi LED'li With Blue LED Sarı LED'li With Yellow LED Yeşil LED'li With Green LED

Kumanda Butonları ve Sinyal Lambaları

Control Units and Pilot Lights



Renk



Colour

Yazı



Pad Printing

Buton Tipi

Button Type

Yaylı Tip

Spring Type

D	Düz Flush
F	Kalıcı Stay Put
H	Çıkık Extended
M	Mantar Ø 40 mm Mushroom Ø 40 mm
M72	Mantar Ø 72 mm Mushroom Ø 72 mm

Seçici Tip

Selector Type

S20	2 Pozisyonlu 2 Position	Kalıcı Stay Put	(0-I) 60°	60°	↙
S21	2 Pozisyonlu 2 Position	Dönüşlü Spring Return	(0-I) 60°	60°	↖
S30	3 Pozisyonlu 3 Position	Kalıcı Stay Put	(II-0-I) 60°	60°	↘
S31	3 Pozisyonlu 3 Position	Tek Dönüşlü Single Spring Return	(II-0-I) 60°	60°	↙
S32	3 Pozisyonlu 3 Position	Çift Dönüşlü Double Spring Return	(II-0-I) 60°	60°	↖

Anahtarlı Tip

Key Operated Type

AA20	2 Pozisyonlu 2 Position	0 Pozisyonunda Anahtarı Çıkan Key Removal at 0 position	Kalıcı Stay Put	(0-I) 60°	60°	↙
AA21	2 Pozisyonlu 2 Position	0 Pozisyonunda Anahtarı Çıkan Key Removal at 0 position	Dönüşlü Spring Return	(0-I) 60°	60°	↖
AA30	3 Pozisyonlu 3 Position	0 Pozisyonunda Anahtarı Çıkan Key Removal at 0 position	Kalıcı Stay Put	(II-0-I) 60°	60°	↘
AA31	3 Pozisyonlu 3 Position	0 Pozisyonunda Anahtarı Çıkan Key Removal at 0 position	Tek Dönüşlü Single Spring Return	(II-0-I) 60°	60°	↙
AA32	3 Pozisyonlu 3 Position	0 Pozisyonunda Anahtarı Çıkan Key Removal at 0 position	Çift Dönüşlü Double Spring Return	(II-0-I) 60°	60°	↖
AC20	2 Pozisyonlu 2 Position	Tüm Pozisyonlarda Anahtarı Çıkan Key Removal at all positions	Kalıcı Stay Put	(0-I) 60°	60°	↙
AC30	3 Pozisyonlu 3 Position	Tüm Pozisyonlarda Anahtarı Çıkan Key Removal at all positions	Kalıcı Stay Put	(II-0-I) 60°	60°	↘
AC31	3 Pozisyonlu 3 Position	Tüm Pozisyonlarda Anahtarı Çıkan Key Removal at all positions	Tek Dönüşlü Single Spring Return	(II-0-I) 60°	60°	↙
AC32	3 Pozisyonlu 3 Position	Tüm Pozisyonlarda Anahtarı Çıkan Key Removal at all positions	Çift Dönüşlü Double Spring Return	(II-0-I) 60°	60°	↖

B	Beyaz White		
K	Kırmızı Red		
M	Mavi Blue		
S	Sarı Yellow		
Y	Yeşil Green		
H	Siyah Mat Black Mat		
BB	Beyaz White	Beyaz White	
HB	Siyah Black	Beyaz White Mat	
HH	Siyah Black	Siyah Black	
KY	Kırmızı Red	Yeşil Green	
SS	Sarı Yellow	Sarı Yellow	
YY	Yeşil Green	Yeşil Green	
0	0		Yazılı Printed
10	I-0		Yazılı Printed
1	I		Yazılı Printed
2	II		Yazılı Printed
12	I-II		Yazılı Printed
L	LIGHT		Yazılı Printed
OD	OK	Vertical Arrow	Dikey Yazılı Printed
OY	OK	Horizontal Arrow	Yatay Yazılı Printed
OK	OK	Special Arrow	Özel Yazılı Printed
OO	OK	Special Arrow	Özel Yazılı Printed
S	Siren İşareti Siren Symbol		Printed
Z	Zil İşareti Bell Symbol		Printed

Örnek: CP1K2DK → Örnek olarak CP plastik serisi, start-stop, 100-230 V AC/DC kırmızı ledli, kırmızı renkli, düz, buton seçilmiştir.

Example: CP1K2DK → CP series, start-stop, 100-230 V AC/DC with red LED, red, Flush button has been selected.

Kumanda Butonları ve Sinyal Lambaları

Control Units and Pilot Lights



CP Plastik Ø 22 mm Kumanda Buton Tipleri

Plastic Ø 22 mm Control Units Types

Yaylı Tip Kumanda Butonlar / Spring Type Control Units

Ürün Kodu	Kontakt Blok Tipi		Işık	Buton Tipi	Renk
Code	Contact Block Type		Illumination	Button Type	Colour
	Normal Açık Normally Open	Normal Kapalı Normally Closed	Opsiyonel Optional		
CP100D*	1	-	√	Düz / Flush	
CP101D*	2	-	√	Düz / Flush	
CP102D*	1	1	√	Düz / Flush	
CP200D*	-	1	√	Düz / Flush	
CP202D*	-	2	√	Düz / Flush	
CP303D*	4	-	√	Düz / Flush	
CP305D*	2	2	√	Düz / Flush	
CP100F*	1	-	√	Kalıcı / Stay Put	
CP101F*	2	-	√	Kalıcı / Stay Put	
CP102F*	1	1	√	Kalıcı / Stay Put	
CP200F*	-	1	√	Kalıcı / Stay Put	
CP202F*	-	2	√	Kalıcı / Stay Put	
CP101H*	1	1	√	Çıkık / Extended	
CP102H*	1	1	√	Çıkık / Extended	
CP200H*	-	1	√	Çıkık / Extended	
CP202H*	-	2	√	Çıkık / Extended	
CP100M*	1	-	-	Mantar / Mushroom	
CP101M*	2	-	-	Mantar / Mushroom	
CP102M*	1	1	-	Mantar / Mushroom	
CP200M*	-	1	-	Mantar / Mushroom	
CP202M*	-	2	-	Mantar / Mushroom	
CP100M72*	1	-	-	Mantar Ø 72 mm / Mushroom Ø 72 mm	
CP200M72*	-	1	-	Mantar Ø 72 mm / Mushroom Ø 72 mm	

• (*) yerine istenen rengin harfi eklenir.

• Please choose the colour and replace (*) with the letter.

• Işık Bloğu seçenekleri için bakınız sayfa 36 Kumanda Butonları Seçim Tablosu.

• See page 36 Control Units Selection table for illumination block types.



CP200DK



CP100HK

Kumanda Butonları ve Sinyal Lambaları

Control Units and Pilot Lights



Seçici Tip Kumanda Butonları / Selector Type Control Units

Ürün Kodu	Kontakt Blok Tipi	Işık	Etiket	Buton Tipi	Pozisyon	Renk	
Code	Contact Block Type	Illumi-nation	Button Plates	Button Type	Position	Colour	
	Normal Açık Normally Open	Normal Kapalı Normally Closed	LED LED				
CP100S20	1	-	√	0-I	Seçici / Selector	2 Pozisyonlu-Kalıcı-60° / 2 Position-Stay Put-60°	H
CP101S20	2	-	√	0-I	Seçici / Selector	2 Pozisyonlu-Kalıcı-60° / 2 Position-Stay Put-60°	H
CP102S20	1	1	√	0-I	Seçici / Selector	2 Pozisyonlu-Kalıcı-60° / 2 Position-Stay Put-60°	H
CP100S21	1	-	√	0-I	Seçici / Selector	2 Pozisyonlu-Kalıcı-60° / 2 Position-Stay Put-60°	H
CP101S21	2	-	√	0-I	Seçici / Selector	2 Pozisyonlu-Kalıcı-60° / 2 Position-Stay Put-60°	H
CP102S21	1	1	√	0-I	Seçici / Selector	2 Pozisyonlu-Kalıcı-60° / 2 Position-Stay Put-60°	H
CP101S30	2	-	√	II-0-I	Seçici / Selector	3 Pozisyonlu-Kalıcı-60° / 3 Position-Stay Put-60°	H
CP102S30	1	1	√	II-0-I	Seçici / Selector	3 Pozisyonlu-Kalıcı-60° / 3 Position-Stay Put-60°	H
CP101S31	2	-	√	II-0-I	Seçici / Selector	3 Pozisyonlu-Tek Dönüşlü-60° / 3 Position-Single Spring Return-60°	H
CP102S31	1	1	√	II-0-I	Seçici / Selector	3 Pozisyonlu-Tek Dönüşlü-60° / 3 Position-Single Spring Return-60°	H
CP101S32	2	-	√	II-0-I	Seçici / Selector	3 Pozisyonlu-Çift Dönüşlü -60° / 3 Position-Double Spring Return-60°	H
CP102S32	1	1	√	II-0-I	Seçici / Selector	3 Pozisyonlu-Çift Dönüşlü -60° / 3 Position-Double Spring Return-60°	H
CP303S30	4	-	√	II-0-I	Seçici / Selector	3 Pozisyonlu-Kalıcı-60° / 3 Position-Stay Put-60°	H
CP305S30	2	2	√	II-0-I	Seçici / Selector	3 Pozisyonlu-Kalıcı-60° / 3 Position-Stay Put-60°	H

• Işık Bloğu seçenekleri için bakınız sayfa 36 Kumanda Butonları Seçim Tablosu.

• See page 36 Control Units Selection table for illumination block types.



CP100S20

Kumanda Butonları ve Sinyal Lambaları

Control Units and Pilot Lights



CP Plastik Ø 22 mm Kumanda Buton Tipleri

Plastic Ø 22 mm Control Units Types

Anahtarlı Tip Kumanda Butonları / Key Operated Type Control Units

Ürün Kodu	Etiket	Tip	Pozisyon	Anahtar Çıkma Pozisyonu
Code	Button Plates	Type	Position	Key Removal Position
CP100AA20	(0-I)	Kalıcı / Stay Put	2 Pozisyonlu / 2 Position	↙ 0
CP101AA20	(0-I)	Kalıcı / Stay Put	2 Pozisyonlu / 2 Position	↙ 0
CP102AA20	(0-I)	Kalıcı / Stay Put	2 Pozisyonlu / 2 Position	↙ 0
CP100AA21	(0-I)	Dönüslü / Spring Return	2 Pozisyonlu / 2 Position	↗ 0
CP101AA21	(0-I)	Dönüslü / Spring Return	2 Pozisyonlu / 2 Position	↗ 0
CP102AA21	(0-I)	Dönüslü / Spring Return	2 Pozisyonlu / 2 Position	↗ 0
CP101AA30	(II-0-I)	Kalıcı / Stay Put	3 Pozisyonlu / 3 Position	↘ 0
CP102AA30	(II-0-I)	Kalıcı / Stay Put	3 Pozisyonlu / 3 Position	↘ 0
CP101AA31	(II-0-I)	Tek Dönüslü / Single Spring Return	3 Pozisyonlu / 3 Position	↘ 0
CP102AA31	(II-0-I)	Tek Dönüslü / Single Spring Return	3 Pozisyonlu / 3 Position	↘ 0
CP101AA32	(II-0-I)	Çift Dönüslü / Double Spring Return	3 Pozisyonlu / 3 Position	↘ 0
CP101AA32	(II-0-I)	Çift Dönüslü / Double Spring Return	3 Pozisyonlu / 3 Position	↘ 0
CP100AC20	(0-I)	Kalıcı / Stay Put	2 Pozisyonlu / 2 Position	↙ Tüm / All
CP101AC20	(0-I)	Kalıcı / Stay Put	2 Pozisyonlu / 2 Position	↙ Tüm / All
CP102AC20	(0-I)	Kalıcı / Stay Put	2 Pozisyonlu / 2 Position	↙ Tüm / All
CP100AC21	(0-I)	Dönüslü / Spring Return	2 Pozisyonlu / 2 Position	↗ Tüm / All
CP101AC21	(0-I)	Dönüslü / Spring Return	2 Pozisyonlu / 2 Position	↗ Tüm / All
CP102AC21	(0-I)	Dönüslü / Spring Return	2 Pozisyonlu / 2 Position	↗ Tüm / All
CP101AC30	(II-0-I)	Kalıcı / Stay Put	3 Pozisyonlu / 3 Position	↘ Tüm / All
CP102AC30	(II-0-I)	Kalıcı / Stay Put	3 Pozisyonlu / 3 Position	↘ Tüm / All
CP101AC31	(II-0-I)	Tek Dönüslü / Single Spring Return	3 Pozisyonlu / 3 Position	↘ Tüm / All
CP102AC31	(II-0-I)	Tek Dönüslü / Single Spring Return	3 Pozisyonlu / 3 Position	↘ Tüm / All
CP101AC32	(II-0-I)	Çift Dönüslü / Double Spring Return	3 Pozisyonlu / 3 Position	↘ Tüm / All
CP101AC32	(II-0-I)	Çift Dönüslü / Double Spring Return	3 Pozisyonlu / 3 Position	↘ Tüm / All



CP100AC20



CP100AA32

Kumanda Butonları ve Sinyal Lambaları

Control Units and Pilot Lights



Acil Stop Tip Kumanda Butonları / Emergency Stop Type Control Units

Ürün Kodu Code	Kontakt Blok Tipi Contact Block Type		Tip Type	Çap (mm) Dia (mm)	Renk Colour
					
	Normal Açık Normally Open	Normal Kapalı Normally Closed			
CP100E	1	-	Çevirmeli / Turn to Release	Ø 40mm	K S
CP102E	1	1	Çevirmeli / Turn to Release	Ø 40mm	K S
CP200E	-	1	Çevirmeli / Turn to Release	Ø 40mm	K S
CP202E	-	2	Çevirmeli / Turn to Release	Ø 40mm	K S
CP100EE	1	-	Etiketli - Çevirmeli / With Label - Turn to Release	Ø 40mm	K
CP102EE	1	1	Etiketli - Çevirmeli / With Label - Turn to Release	Ø 40mm	K
CP200EE	-	1	Etiketli - Çevirmeli / With Label - Turn to Release	Ø 40mm	K
CP202EE	-	2	Etiketli - Çevirmeli / With Label - Turn to Release	Ø 40mm	K
CP100EP	1	-	Pencereli-Çekmeli / With Window-Pull to Release	Ø 40mm	K
CP102EP	1	1	Pencereli-Çekmeli / With Window-Pull to Release	Ø 40mm	K
CP200EP	-	1	Pencereli-Çekmeli / With Window-Pull to Release	Ø 40mm	K
CP202EP	-	2	Pencereli-Çekmeli / With Window-Pull to Release	Ø 40mm	K
CP100EK30	1	-	Çevirmeli Kısa / Short, Turn to Release	Ø 30mm	K
CP102EK30	1	1	Çevirmeli Kısa / Short, Turn to Release	Ø 30mm	K
CP200EK30	-	1	Çevirmeli Kısa / Short, Turn to Release	Ø 30mm	K
CP202EK30	-	2	Çevirmeli Kısa / Short, Turn to Release	Ø 30mm	K
CP100E30	1	-	Çevirmeli / Turn to Release	Ø 30mm	K
CP102E30	1	1	Çevirmeli / Turn to Release	Ø 30mm	K
CP200E30	-	1	Çevirmeli / Turn to Release	Ø 30mm	K
CP202E30	-	2	Çevirmeli / Turn to Release	Ø 30mm	K
CP102ES30	1	1	Sinyalli-Çevirmeli / With Signal-Turn to Release	Ø 30mm	K
CP200ES30	-	1	Sinyalli-Çevirmeli / With Signal-Turn to Release	Ø 30mm	K
CP102EA30	1	1	Anahtarlı-Çevirmeli / Key Operated-Turn to Release	Ø 30mm	K
CP200EA30	-	1	Anahtarlı-Çevirmeli / Key Operated-Turn to Release	Ø 30mm	K
CP102EC	1	1	Çekmeli / Pull to Release	Ø 40mm	K
CP200EC	-	1	Çekmeli / Pull to Release	Ø 40mm	K
CP102ECN30	1	1	Çekmeli / Pull to Release	Ø 30mm	K
CP200ECN30	-	1	Çekmeli / Pull to Release	Ø 30mm	K
CP102ECS30	1	1	Sinyalli-Çekmeli / With Signal-Pull to Release	Ø 30mm	K
CP200ECS30	-	1	Sinyalli-Çekmeli / With Signal-Pull to Release	Ø 30mm	K



CP200E



CP200EE



CP200EP



CP200EC



CP200EK30



CP200EA30

Kumanda Butonları ve Sinyal Lambaları

Control Units and Pilot Lights



CP Plastik Ø 22 mm Kumanda Buton Tipleri

Plastic Ø 22 mm Control Units Types

Çiftli Tip Kumanda Butonları / Double Type Control Units



CP102K20KY

Ürün Kodu	Kontakt Blok Tipi		Işık	Buton Tipi	Renk	
Code	Contact Block Type		Illumination	Control Unit Type	Colour	
	Normal Açık Normally Open	Normal Kapalı Normally Closed	Opsiyonel Optional			
CP102K20HB	1	1	✓	Çiftli / Double	Düz Kafalı / Flush	
CP102K20HS	1	1	✓	Çiftli / Double	Düz Kafalı / Flush	
CP102K20KY	1	1	✓	Çiftli / Double	Düz Kafalı / Flush	
CP102K21HB	1	1	✓	Çiftli / Double	1 Çıkık Kafalı / Single Extended	
CP102K21KY	1	1	✓	Çiftli / Double	1 Çıkık Kafalı / Single Extended	

- Işık Bloğu seçenekleri için bakınız sayfa 36 Kumanda Butonları Seçim Tablosu.
- See page 36 Control Units Selection table for illumination block types.
- Standart çiftli buton B102K20KY, kırmızı / yeşil ve şeffaftır.
- Standard double head control unit is B102K20KY which is red/green and transparent.
- • Çiftli butonda sadece kırmızı ve siyah renkli basma düğmeleri çıkıktır.
- • • For double head control unit, only red and black colored buttons are extended position.

Joystick Tip Kumanda Butonları / Joystick Type Control Units



CP707DJ40

Ürün Kodu	Kontakt Blok Tipi	Tip	Pozisyon	Renk	
Code	Contact Block Type	Type	Position	Colour	
	Normal Açık Normally Open	Normal Kapalı Normally Closed			
CP101DJ20	2	-	Kalıcı / Stay Put	2 Pozisyonlu / 2 Position	
CP101DJ21	2	-	Dönüşlü / Spring Return	2 Pozisyonlu / 2 Position	
CP102DJ21	1	1	Dönüşlü / Spring Return	2 Pozisyonlu / 2 Position	
CP707DJ40	4	-	Kalıcı / Stay Put	2 Pozisyonlu / 2 Position	
CP707DJ41	4	-	Dönüşlü / Spring Return	2 Pozisyonlu / 2 Position	

Sinyaller / Pilot Lights



CP060XK

Ürün Kodu	Işık	Nominal Gerilim	Renk
Code	Illumination	Nominal Voltage	Colour
CP050XB	LED	12 - 30V AC/DC	
CP060XK	LED	12 - 30V AC/DC	
CP070XM	LED	12 - 30V AC/DC	
CP080XS	LED	12 - 30V AC/DC	
CP090XY	LED	12 - 30V AC/DC	
CP0B0XB	LED	100 - 230V AC	
CP0K0XK	LED	100 - 230V AC	
CP0M0XM	LED	100 - 230V AC	
CP0S0XS	LED	100 - 230V AC	
CP0Y0XY	LED	100 - 230V AC	

Kumanda Butonları ve Sinyal Lambaları

Control Units and Pilot Lights



Kontakt Blok Tipler / Contact Block Types

Ürün Kodu	Kontakt Blok Tipi	Işık	Nominal Akım	Nominal Gerilim	Kullanım Yeri	Renk
Code	Contact Block Type	Illumination	Nominal Current	Nominal Voltage	Place of Use	Colour
C1	1	-	4A	230V AC	Butonluk / For Control Units	
C1AU			4A	230V AC	Butonluk -Altın Kaplamalı/ For Control Units-Gold Plated	
C2	1	-	4A	230V AC	Butonluk / For Control Units	
C2AU			4A	230V AC	Butonluk -Altın Kaplamalı / For Control Units-Gold Plated	
C12			4A	230V AC	Joystick- Butonluk / Joystick For Control Units	
CB5		LED	5-20mA	12-30V AC/DC	Butonluk / For Control Units	B
CB6		LED	5-20mA	12-30V AC/DC	Butonluk / For Control Units	K
CB7		LED	5-20mA	12-30V AC/DC	Butonluk / For Control Units	M
CB8		LED	5-20mA	12-30V AC/DC	Butonluk / For Control Units	S
CB9		LED	5-20mA	12-30V AC/DC	Butonluk / For Control Units	Y
CBB		LED	5-15mA	100-230V AC	Butonluk / For Control Units	B
CBK		LED	5-15mA	100-230V AC	Butonluk / For Control Units	K
CBM		LED	5-15mA	100-230V AC	Butonluk / For Control Units	M
CBS		LED	5-15mA	100-230V AC	Butonluk / For Control Units	S
CBY		LED	5-15mA	100-230V AC	Butonluk / For Control Units	Y
CBB4		LED	4-5mA	110V AC/DC	Butonluk / For Control Units	B
CBK4		LED	4-5mA	110V AC/DC	Butonluk / For Control Units	K
CBM4		LED	4-5mA	110V AC/DC	Butonluk / For Control Units	M
CBS4		LED	4-5mA	110V AC/DC	Butonluk / For Control Units	S
CBY4		LED	4-5mA	110V AC/DC	Butonluk / For Control Units	Y
C3	1		4A	230V AC	Kutuluk / For Boxes	
C4	1		4A	230V AC	Kutuluk / For Boxes	
C3CK	1		4A	230V AC	C Serisi Butona Uygun Kutuluk / Suitable for C Series Control Unit For Boxes	
C4CK	1		4A	230V AC	C Serisi Butona Uygun Kutuluk / Suitable for C Series Control Unit For Boxes	
C3BK	1		4A	230V AC	B Serisi Butona Uygun Kutuluk / Suitable for B Series Control Unit For Boxes	
C4BK	1		4A	230V AC	B Serisi Butona Uygun Kutuluk / Suitable for B Series Control Unit For Boxes	
CK5		LED	5-20 mA	12-30V AC/DC	Kutuluk / For Boxes	B
CK6		LED	5-20 mA	12-30V AC/DC	Kutuluk / For Boxes	K
CK7		LED	5-20 mA	12-30V AC/DC	Kutuluk / For Boxes	M
CK8		LED	5-20 mA	12-30V AC/DC	Kutuluk / For Boxes	S
CK9		LED	5-20 mA	12-30V AC/DC	Kutuluk / For Boxes	Y
CKB		LED	5-15 mA	100-230V AC/DC	Kutuluk / For Boxes	B
CKK		LED	5-15 mA	100-230V AC/DC	Kutuluk / For Boxes	K
CKM		LED	5-15 mA	100-230V AC/DC	Kutuluk / For Boxes	M
CKS		LED	5-15 mA	100-230V AC/DC	Kutuluk / For Boxes	S
CKY		LED	5-15 mA	100-230V AC/DC	Kutuluk / For Boxes	Y
CKB4		LED	4-5 mA	110V AC/DC	Kutuluk / For Boxes	B
CKK4		LED	4-5 mA	110V AC/DC	Kutuluk / For Boxes	K
CKM4		LED	4-5 mA	110V AC/DC	Kutuluk / For Boxes	M
CKS4		LED	4-5 mA	110V AC/DC	Kutuluk / For Boxes	S
CKY4		LED	4-5 mA	110V AC/DC	Kutuluk / For Boxes	Y

• Maksimum 3 adet kontak blok arka arkaya eklenebilir.

• Max. 3 contact blocks can be added subsequently.

• • C1AU, C2AU Altın kaplamalı kontak blok.

• • C1AU, C2AU gold plated contact block.

• • • C12, Joystic kontak blok.

• • • C12, Joystick contact block.



C1



C2



C3



C4



CKM

Kumanda Butonları ve Sinyal Lambaları

Control Units and Pilot Lights



CP Plastik Ø 22 mm Kumanda Buton Tipleri

Plastic Ø 22 mm Control Units Types

Yedekler / Spare Parts

Ürün Kodu	Çap (mm)	Buton Tipi	Pozisyon	Renk
Code	Dia (mm)	Control Unit Types	Position	Colour
CPDD*		Düz / Flush		
CPDF*		Kalıcılı / Stay Put		
CPDH*		Çıkık / Extended		
CPDM*		Mantar / Mushroom		
CPDM72*	Ø 72mm	Mantar / Mushroom		
CPDS20		Seçici / Selector	2 Pozisyonlu-Kalıcı-60° / 2 Position-Stay Put-60°	
CPDS21		Seçici / Selector	2 Pozisyonlu-Dönüslü-60° / 2 Position-Spring Return-60°	
CPDS30		Seçici / Selector	3 Pozisyonlu-Kalıcı -60° / 3 Position-Stay Put-60°	
CPDS31		Seçici / Selector	3 Pozisyonlu-Çift Dönüslü -60° / 3 Position-Double Spring Return-60°	
CPDS32		Seçici / Selector	3 Pozisyonlu-Tek Dönüslü-60° / 3 Position-Single Spring Return-60°	
CPDAA20		Anahtarlı / Key Operated	2 Pozisyonlu- Kalıcı / 2 Position-Stay Put	
CPDAA21		Anahtarlı / Key Operated	2 Pozisyonlu, Dönüslü / 2 Position, Spring Return	
CPDAA30		Anahtarlı / Key Operated	3 Pozisyonlu, Kalıcı / 3 Position, Stay Put	
CPDAA31		Anahtarlı / Key Operated	3 Pozisyonlu, Tek Dönüslü / 3 Position, Single Spring Return	
CPDAA32		Anahtarlı / Key Operated	3 Pozisyonlu, Çift Dönüslü / 3 Position, Double Spring Return	
CPDAC20		Anahtarlı / Key Operated	2 Pozisyonlu, Kalıcı / 2 Position, Stay Put	
CPDAC21		Anahtarlı / Key Operated	2 Pozisyonlu, Dönüslü / 2 Position, Spring Return	
CPDAC30		Anahtarlı / Key Operated	3 Pozisyonlu, Kalıcı / 3 Position, Stay Put	
CPDAC31		Anahtarlı / Key Operated	3 Pozisyonlu-Tek Dönüslü / 3 Position - Single Spring Return	
CPDAC32		Anahtarlı / Key Operated	3 Pozisyonlu -Çift Dönüslü / 3 Position - Double Spring Return	
CPDE		Acil Stop / Emergency Stop	Çevirmeli / Turn to Release	
CPDEE	Ø 40mm	Acil Stop / Emergency Stop	Etiketli - Çevirmeli / With Label - Turn to Release	
CPDEP	Ø 40mm	Acil Stop / Emergency Stop	Pencereli-Çekmeli / With Window-Pull to Release	
CPDEK30	Ø 30mm	Acil Stop / Emergency Stop	Kısa, Çevirmeli / Short, Turn to Release	
CPDE30	Ø 30mm	Acil Stop / Emergency Stop	Çevirmeli / Turn to Release	
CPDES30	Ø 30mm	Acil Stop / Emergency Stop	Sinyalli-Çevirmeli / With Signal-Turn to Release	
CPDEA30	Ø 30mm	Acil Stop / Emergency Stop	Anahtarlı-Çevirmeli / Key Operated-Turn to Release	
CPDEC	Ø 40mm	Acil Stop / Emergency Stop	Çekmeli / Pull to Release	
CPDECN30	Ø 30mm	Acil Stop / Emergency Stop	Çekmeli / Pull to Release	
CPDECS30	Ø 30mm	Acil Stop / Emergency Stop	Sinyalli-Çekmeli / With Signal-Pull to Release	
CPDK20KY		Çiftli / Double	Düz Kafalı / Flush	
CPDK20HB		Çiftli / Double	Düz Kafalı / Flush	
CPDK20HS		Çiftli / Double	Düz Kafalı / Flush	
CPDK21KY		Çiftli / Double	1 Çıkık Kafalı / Single Extended	
CP102K21HB		Çiftli / Double	1 Çıkık Kafalı / Single Extended	
CPDJ20		Joystick	2 Pozisyonlu-Kalıcı / 2 Position-Stay Put	
CPDJ21		Joystick	2 Pozisyonlu-Dönüslü / 2 Position-Spring Return	
CPDJ40		Joystick	4 Pozisyonlu-Kalıcı / 4 Position-Stay Put	
CPDJ41		Joystick	4 Pozisyonlu-Dönüslü / 4 Position-Spring Return	
CPDX*		Sinyal / Pilot Lights	Plastik / Plastic	



CPDY



CPDS20

Kumanda Butonları ve Sinyal Lambaları

Control Units and Pilot Lights



Özel Tampon Baskılı Butonlar / Special Pad Printed Control Units

Ürün Kodu / Code	CP102K20KY-10	CP101K20YY-12	CP101K20YY-OK	CP102K20HB-10	CP101K20HH-OK	CP101K20BB-12	CP101K20SH-10	CP101K20SS-12
Baskı / Print	I-0	I-II	Oklu / Arrow Symbol	I-0	Oklu / Arrow Symbol	I-II	I-0	I-II
Ürün Kodu / Code	CP100DY-0D	CP100DY-0Y	CP100DH-0D	CP100DH-0Y	CP100DB-0D	CP100DB-0Y	CP100DB-Z	CP100DB-L
Baskı / Print	Dikey Oklu Vertical Arrow	Yatay Oklu Horizontal Arrow	Dikey Oklu Vertical Arrow	Yatay Oklu Horizontal Arrow	Dikey Oklu Vertical Arrow	Yatay Oklu Horizontal Arrow	Zil / Bell	Lamba / Lamp
Ürün Kodu / Code	CP100DY-1	CP100DY-2	CP100DB-1	CP100DB-2	CP200DK-0	CP200DH-0	CP200DS-Z	CP200DS-L
Baskı / Print	I	II	I	II	0	0	Zil / Bell	Lamba / Lamp

Not: Minimum Sipariş miktarı 50 Adettir.

Note : Minimum Order Quantity : 50 pcs

Aksesuarlar / Accessories

Ürün Kodu	Tip	Özellik	Etiket	Malzeme
Code	Types	Features	Button Plates	Material
CA	Adaptör / Adapter			
CA11				
CBUTONORTA	Kontakt Baskı Parçası / Middle Contact Activator			
CEA	Ek Adaptör / Additional Adapter			
CMB				
CMSB				
CMUHFAZA	Emniyet Koruma / Emergency Protective Cover			
BCIFTLİROZET18	Çiftli Rozet / Double Legend Plate Holder	18mm		
BEB	Etanj Başlık / Silicon Cover	Düz Buton 22mm / Flush Button 22mm		
BEBK20	Etanj Başlık / Silicon Cover	Çiftli Butonlar / Double Buttons		
BEBK21	Etanj Başlık / Silicon Cover	1 Çıkık Kafalı-Çiftli Butonlar Single Extended-Double Buttons		
BMUHFAZA	Emniyet Koruma / Emergency Protective Cover	Darbe Muhafaza / Stroke Protection		
BPROT	Buton Koruma / Protective Cover	Darbe Muhafaza / Stroke Protection		
BPUL	Pul / Legend Plate	Buton Sıkıştırma / Button Tightening		
BROZET08	Rozet / Legend Plate Holder	8mm		
BROZET18	Rozet / Legend Plate Holder	18mm		
BSOMAN	Somun Anahtarları / Nut Tightener			
BET08	Etiket / Legend Plate	8mm	BOŞ	
BET08-01	Etiket / Legend Plate	8mm	(0-1)	
BET08-01OK	Etiket / Legend Plate	8mm	(0-1) OKLU	
BET08-12	Etiket / Legend Plate	8mm	(I-II)	
BET08-201	Etiket / Legend Plate	8mm	(2-0-1)	

Kumanda Butonları ve Sinyal Lambaları

Control Units and Pilot Lights



CP Plastik Ø 22 mm Kumanda Buton Tipleri

Plastic Ø 22 mm Control Units Types

Aksesuarlar / Accessories

Ürün Kodu	Tip	Özellik	Etiket	Malzeme
Code	Types	Features	Button Plates	Material
BET08-2010K	Etiket / Legend Plate	8mm	(2-0-1) OKLU	
BET08-2010K2	Etiket / Legend Plate	8mm	(2-0-1) ÇİFT OKLU	
BET08-START	Etiket / Legend Plate	8mm	START	
BET08-STOP	Etiket / Legend Plate	8mm	STOP	
BET18	Etiket / Legend Plate	18mm	BOŞ	
BET18-01	Etiket / Legend Plate	18mm	(0-1)	
BET18-START	Etiket / Legend	18mm	START	
BET48P	Etiket / Legend Plate	48mm	EMERGENCY	Plastik / Plastic
BET60A	Etiket / Legend Plate	60mm	ACİL STOP	Alüminyum / Aluminium
BET60LED1	Etiket-Işıkli-24V AC/DC Plate-With LED-24V AC/DC	60mm	ACİL STOP - EMERGENCY STOP	
BET60LED2	Etiket-Işıkli-24V AC/DC Plate-With LED-24V AC/DC	60mm	EMERGENCY STOP - EMERGENCY STOP	
BET60P	Etiket / Legend Plate	60mm	EMERGENCY STOP	Plastik / Plastic
BET60P1	Etiket / Legend Plate	60mm	ACİL DURDURMA	Plastik / Plastic
BET60P2	Etiket / Legend Plate	60mm	ARRET D'URGENCE	Plastik / Plastic
BET90A	Etiket / Legend Plate	90mm	ACİL STOP	Alüminyum / Aluminium
BET90P	Etiket / Plate	90mm	ACİL STOP	Plastik / Plastic
BET90P-1	Etiket / Plate	90mm	ACİL DURDURMA	Plastik / Plastic



BROZET18



BROZET08



BET60LED1



BET60LED2



BET60P



BPUL



BPROT



BMUHAFAZA

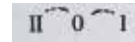

BET08-2010K2



BET08-2010K



BET08



BET18



BET08-START



BET08-STOP



BET08-01



BET08-010K



BET08-201

MONTAJ ŞEKLİ / ASSEMBLY

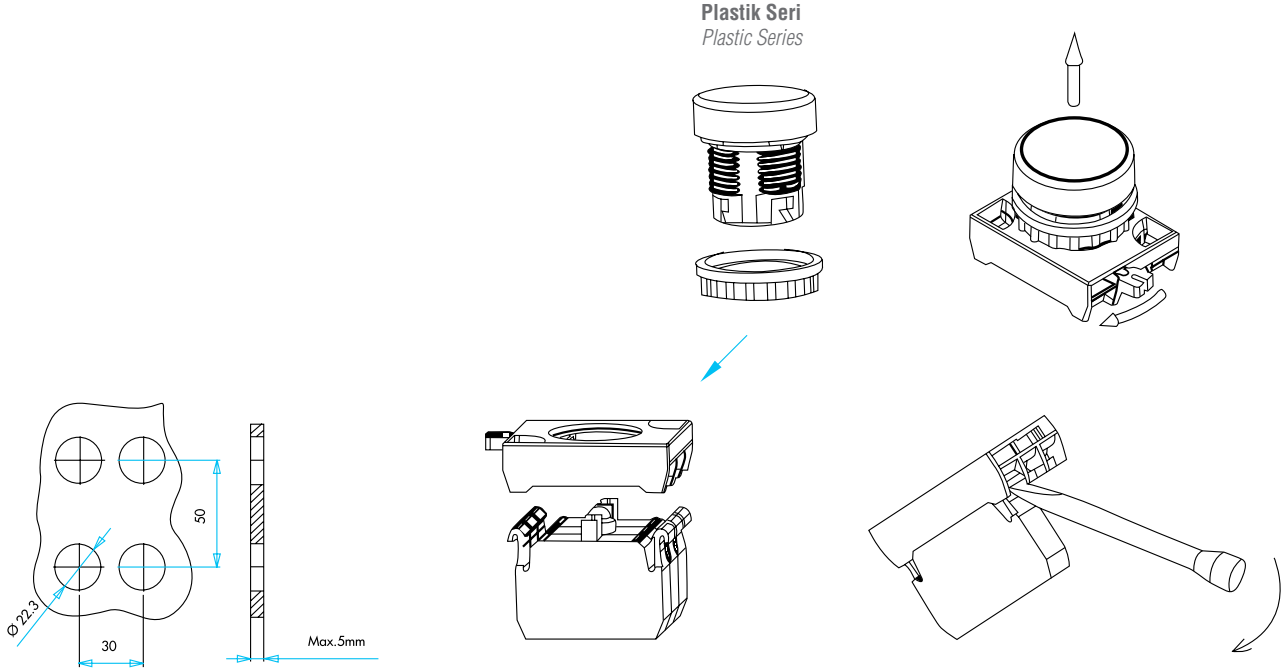

BOYUTLAR (mm) / DIMENSIONS (mm)

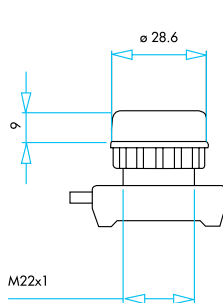

Düz, Yaylı
Flush, Spring Return

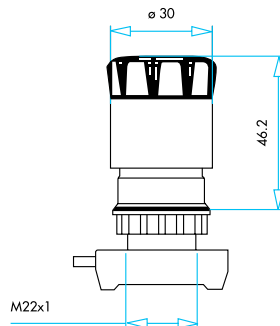

Acil Stop Ø 30 mm
Emergency Stop Ø 30 mm

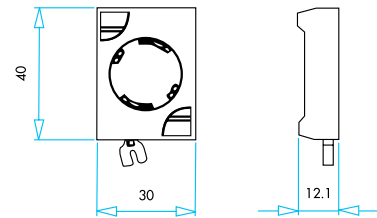

Adaptör
Adapter



D Serisi Ø 16mm Kumanda Butonları

- Dar alanlarda kullanım kolaylığı
- Darbe dayanıklı polikarbonat buton lensi
- Alev almayan V0 PA6.6 kontak bloklar
- İstenildiğinde çeşitli ışıklı kontak blokların uygunluğu
- Adaptöre kontak blokların takılmasında alete ihtiyaç olmaması
- Led ışıkla, minimum ısınma maksimum ömür
- Tüm uygulamalara cevap verecek ürün çeşitliliği

Teknik Bilgiler

Mekanik Ömür	: 500.000 açma-kapama min.
Elektriksel Ömür	: 100.000 açma-kapama min.
Çalışma Sıcaklığı	: min./maks. °C -5/+40
Koruma Sınıfı	: IP50
Çalışma Sıklığı	: Yüksüz 3.000 açma-kapama/saat
	: Yükte 1.200 açma-kapama/saat
Çalışma Gerilimi (Ue)	: 250 V AC
Çalışma Akımı (Ie)	: 1,5 A
Yalıtım Gerilimi (Ui)	: 250 V
Darbe Dayanım Gerilimi (Uimp)	: 2,5 kV
Kısa Devre Kesme Kap. (Icn)	: 1 kA
İzolasyon Direnci	: 10 MΩ min. (500 V DC)
Kullanım Sınıfı	: AC15
Dielektrik Mukavemeti	: 1.500 V AC (1 dakika için)
Standart Kontak Malzemesi	: AgNi
Bağlantı Kablo Kesiti	: FASTON 2,8x0,5 mm
Standart	: TS EN 60947-5-1 VDE0660



D Series Ø 16mm Control Units

- Ease of use in limited spaces
- Impact-resistant polycarbonate button lens
- Non-flammable V0 PA6.6 contact blocks
- Various illumination contact blocks availability on request
- Tools not required to attach contact blocks to adapter
- With LED illumination, minimum warm-up and maximum lifetime
- Variety of products for all areas of application

Technical Information

Mechanical Life	: 500.000 operations min.
Electrical Life	: 100.000 operations min.
Operating Temperature	: min./max. °C -5/+40
Protection Degree	: IP50
Operating Frequency	: Without load 3.000 operations/hour
	: At full load 1.200 operations/hour
Operating Voltage (Ue)	: 250 V AC
Operating Current (Ie)	: 1,5 A
Insulation Voltage (Ui)	: 250 V
Impact Resistance (Uimp)	: 2,5 kV
Short Circuit Breaking Capacity (Icn)	: 1 kA
Insulation Resistance	: 10 MΩ min. (500 V DC)
Utilization Category	: AC15
Dielectric Strength	: 1.500 V AC (For 1 minute)
Standard Contact Material	: AgNi
Cable Section	: FASTON 2,8x0,5 mm
Standard	: TS EN 60947-5-1 VDE0660



Kumanda Butonları ve Sinyal Lambaları Control Units and Pilot Lights



D Serisi Ø 16mm Kumanda Butonları Genel Şema

D Series Ø 16mm Control Units General Scheme

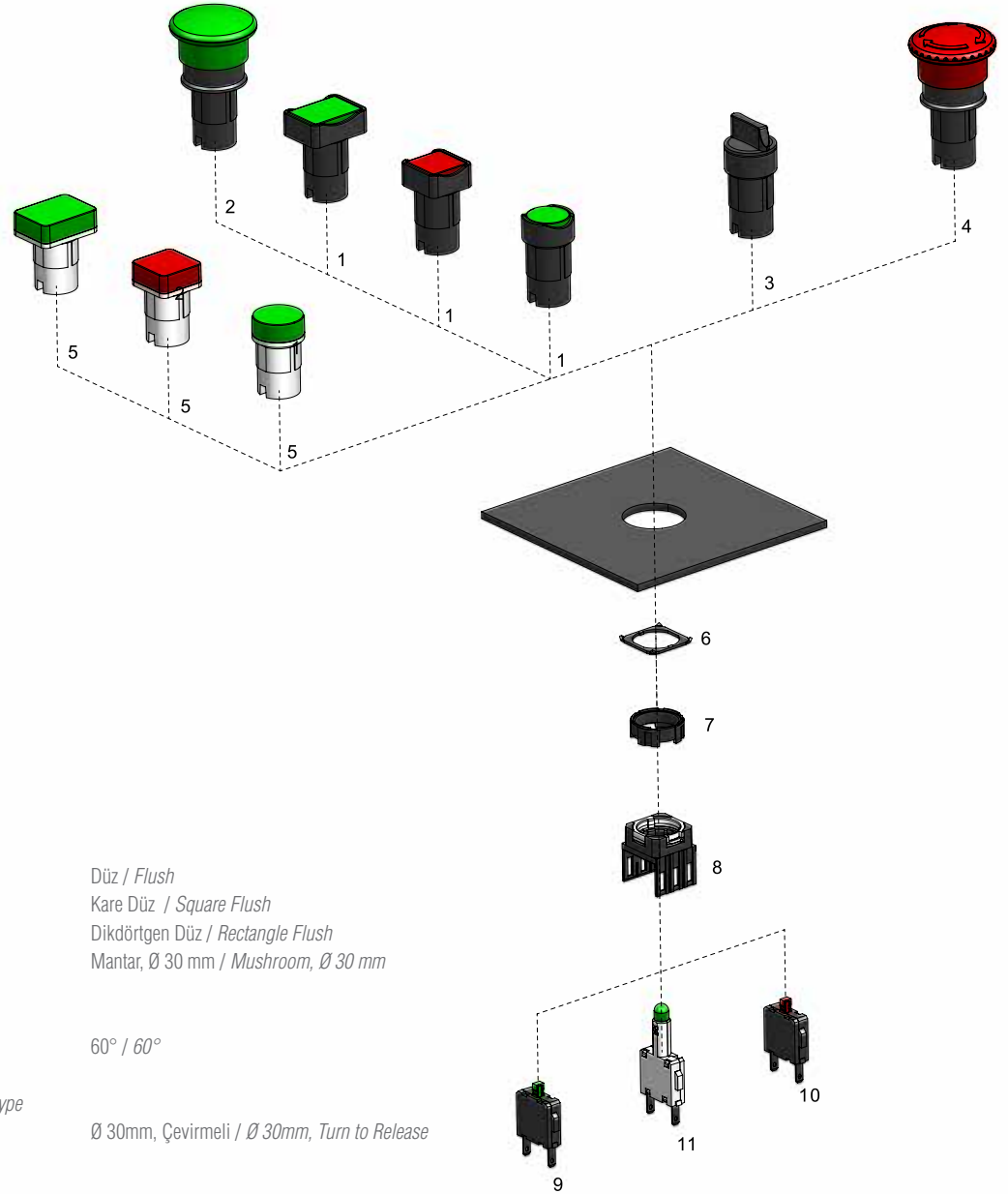

Yaylı Tip / Spring Type

- | | | |
|---|-----|-------------------------------------|
| 1 | YD | Düz / Flush |
| 1 | KD | Kare Düz / Square Flush |
| 1 | DD | Dikdörtgen Düz / Rectangle Flush |
| 2 | M30 | Mantar, Ø 30 mm / Mushroom, Ø 30 mm |

Seçici Tip / Selector Type

- | | | |
|---|---|-----------|
| 3 | S | 60° / 60° |
|---|---|-----------|

Acil Stop / Emergency Stop Type

- | | | |
|---|-----|---|
| 4 | E30 | Ø 30mm, Çevirmeli / Ø 30mm, Turn to Release |
|---|-----|---|

Sinyal / Pilots

- | | | |
|---|----|--|
| 5 | KX | D Serisi Ø 16mm, Kare, Sinyal / D Series Ø 16mm, Square, Pilots |
| 5 | DX | D Serisi Ø 16mm, Dikdörtgen, Sinyal / D Series Ø 16mm, Rectangle, Pilots |
| 5 | YX | D Serisi Ø 16mm, Yuvarlak, Sinyal, / D Series Ø 16mm, Round, Pilots |

Aksesuarlar / Accessories

- | | | |
|----|------------------|--|
| 6 | DPUL | Metal Pul / Metal Washer |
| 7 | SOMUN | Plastik Somun / Plastic Nut |
| 8 | ADAPTÖR | Adaptör / Adapter |
| 9 | START KONTAKBLOK | Kontakt Blok, Start (NA) / Contact Block, Start (NO) |
| 10 | STOP KONTAKBLOK | Kontakt Blok, Stop (NK) / Contact Block, Stop (NC) |
| 11 | LED KONTAKBLOK | Kontakt Blok, LED / Contact Block, LED |

Kumanda Butonları ve Sinyal Lambaları

Control Units and Pilot Lights

EMES®

D Serisi Kumanda Butonlar Seçim Tablosu

Series Control Units Selection Table

Seri	Kontakt Blok Kombinasyonu	Buton Şekli	Buton Tipi	Renk
D Series	1 6 2 Contact Block Combination	D Button Shape	D Button Type	K Colour
Seri Series	Kontakt Blok Tipi Contact Block Type	Buton Şekli Button Shape	Buton Tipi Button Type	Renk Colour
D Serisi Ø 16mm Kumanda Butonu Series Ø 16mm Control Units	0 Boş Empty 1 Start Butonluk Start For Button 2 Stop Butonluk Stop For Button	0 Boş Empty 1 Start Butonluk Start For Button 2 Stop Butonluk Stop For Button	Yaylı Tip Spring Type D Düz Flush M30 Mantar Ø 30 mm Mushroom Ø 30 mm	K Kırmızı Red
Kontakt Blok Tipi Contact Block Type	0 Boş Empty 1 Start Butonluk Start For Button 2 Stop Butonluk Stop For Button	Buton Şekli Button Shape 0 Boş Empty 1 Start Butonluk Start For Button 2 Stop Butonluk Stop For Button	Seçici Tip Selector Type S20 2 Pozisyonlu 2 Position S21 2 Pozisyonlu 2 Position S30 3 Pozisyonlu 3 Position S31 3 Pozisyonlu 3 Position S32 3 Pozisyonlu 3 Position	Renk Colour K Kırmızı Red M Mavi Blue S Sarı Yellow Y Yeşil Green H Siyah Black
Işık Bloğu Tipi Illumination Block Type	0 Boş Without Illumination 5 12 - 24V AC/DC Beyaz LED'li 12 - 24V AC/DC With White LED 6 12 - 24V AC/DC Kırmızı LED'li 12 - 24V AC/DC With Red LED 7 12 - 24V AC/DC Mavi LED'li 12 - 24V AC/DC With Blue LED 8 12 - 24V AC/DC Sarı LED'li 12 - 24V AC/DC With Yellow LED 9 12 - 24V AC/DC Yeşil LED'li 12 - 24V AC/DC With Green LED	Kontakt Blok Tipi Contact Block Type D Dikdörtgen Rectangle K Kare Square Y Yuvarlak Round	Acil Stop Tip Emergency Stop Type E30 Ø 30mm Ø 30mm Çevirmeli Turn to Release	Sinyal Pilot Lights X Sinyal Pilot Lights

Örnek: D162DDK → D serisi, start-stop, 12 - 24V AC/DC, kırmızı LED'li, kırmızı renkli, Dikdörtgen, Düz, buton seçilmiştir.



Example: D162DDK → D series, start-stop, 12 - 24V AC/DC, with red LED, Rectangle, Flush button has been selected.

Kumanda Butonları ve Sinyal Lambaları

Control Units and Pilot Lights



Yaylı Tip Kumanda Butonlar / Spring Type Control Units

Ürün Kodu	Kontakt Blok Tipi	Işık	Buton Tipi	Buton Şekli	Renk	
Code	Contact Block Type	Illumination	Button Type	Button Shape	Colour	
	 Normal Açık Normally Open	 Normal Kapalı Normally Closed	Opsiyonel Optional			
D100DD*	1	-	√	Düz / Flush	Dikdörtgen / Rectangle	
D101DD*	2	-	√	Düz / Flush	Dikdörtgen / Rectangle	
D102DD*	1	1	√	Düz / Flush	Dikdörtgen / Rectangle	
D200DD*	-	1	√	Düz / Flush	Dikdörtgen / Rectangle	
D202DD*	-	2	√	Düz / Flush	Dikdörtgen / Rectangle	
D100KD*	1	-	√	Düz / Flush	Kare / Square	
D101KD*	2	-	√	Düz / Flush	Kare / Square	
D102KD*	1	1	√	Düz / Flush	Kare / Square	
D200KD*	-	1	√	Düz / Flush	Kare / Square	
D202KD*	-	2	√	Düz / Flush	Kare / Square	
D100YD*	1	-	√	Düz / Flush	Yuvarlak / Round	
D101YD*	2	-	√	Düz / Flush	Yuvarlak / Round	
D102YD*	1	1	√	Düz / Flush	Yuvarlak / Round	
D200YD*	-	1	√	Düz / Flush	Yuvarlak / Round	
D202YD*	-	2	√	Düz / Flush	Yuvarlak / Round	
D100YM30*	1	-	-	Mantar Ø 30 mm / Mushroom Ø 30 mm	Yuvarlak / Round	
D200YM30*	-	1	-	Mantar Ø 30 mm / Mushroom Ø 30 mm	Yuvarlak / Round	



D100DDY



D200KDK



D200YDK

Seçici Tip Kumanda Butonları / Selector Type Control Units

Ürün Kodu	Buton Tipi	Pozisyon	Renk
Code	Button Type	Position	Colour
D100YS20	Seçici / Selector	2 Pozisyonlu-Kalıcı-60° / 2 Position-Stay Put-60°	
D100YS21	Seçici / Selector	2 Pozisyonlu-Dönüşlü-60° / 2 Position-Spring Return-60°	
D101YS30	Seçici / Selector	3 Pozisyonlu-Kalıcı-60° / 3 Position-Stay Put-60°	
D101YS31	Seçici / Selector	3 Pozisyonlu-Tek Dönüşlü-60° / 3 Position-Single Spring Return-60°	
D101YS32	Seçici / Selector	3 Pozisyonlu-Çift Dönüşlü-60° / 3 Position-Double Spring Return-60°	



D101YS30

Kumanda Butonları ve Sinyal Lambaları

Control Units and Pilot Lights



D Serisi Ø 16 mm Kumanda Buton Tipleri

Series Ø 16 mm Control Units Types

Acil Stop Tip Kumanda Butonları / Emergency Stop Type Control Units

Ürün Kodu	Kontakt Blok Tipi	Etiket	Tip	Çap (mm)	Renk
Code	Contact Block Type	Button Plates	Type	Dia (mm)	Colour
D102YE30*	1	1	Çevirmeli / Turn to Release	Ø 30mm	K
D200YE30*	1	-	Çevirmeli / Turn to Release	Ø 30mm	K

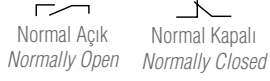

D200YE30

Sinyaller / Pilot Lights

Ürün Kodu	Işık	Nominal Gerilim	Buton Şekli	Renk
Code	Illumination	Nominal Voltage	Button Shape	Colour
D050DXB	LED	12 - 24V AC/DC	Dikdörtgen / Rectangle	B
D050KXB	LED	12 - 24V AC/DC	Kare / Square	B
D050YXB	LED	12 - 24V AC/DC	Yuvarlak / Round	B
D060DXK	LED	12 - 24V AC/DC	Dikdörtgen / Rectangle	K
D060KXK	LED	12 - 24V AC/DC	Kare / Square	K
D060YXK	LED	12 - 24V AC/DC	Yuvarlak / Round	K
D070DXM	LED	12 - 24V AC/DC	Dikdörtgen / Rectangle	M
D070KXM	LED	12 - 24V AC/DC	Kare / Square	M
D070YXM	LED	12 - 24V AC/DC	Yuvarlak / Round	M
D080DXS	LED	12 - 24V AC/DC	Dikdörtgen / Rectangle	S
D080KXS	LED	12 - 24V AC/DC	Kare / Square	S
D080YXS	LED	12 - 24V AC/DC	Yuvarlak / Round	S
D090DXY	LED	12 - 24V AC/DC	Dikdörtgen / Rectangle	Y
D090KXY	LED	12 - 24V AC/DC	Kare / Square	Y
D090YXY	LED	12 - 24V AC/DC	Yuvarlak / Round	Y



D060DXK



D080KXS



D070YXM

Kumanda Butonları ve Sinyal Lambaları

Control Units and Pilot Lights



Kontakt Blok Tipleri / Contact Block Types

Ürün Kodu Code	Kontakt Blok Tipi Contact Block Type		Işık Illumination	Nominal Gerilim Nominal Voltage	Renk Colour
D1	1	-	-	240V	-
D2	-	1	-	240V	-
D5	-	-	LED	12 - 24V AC/DC	B
D6	-	-	LED	12 - 24V AC/DC	K
D7	-	-	LED	12 - 24V AC/DC	M
D8	-	-	LED	12 - 24V AC/DC	S
D9	-	-	LED	12 - 24V AC/DC	Y



D9



D2

Yedekler / Spare Parts

Ürün Kodu Code	Buton Şekli Button Shape	Buton Tipi Control Unit Types	Renk Colour
DDD*	Dikdörtgen / Rectangle	Düz / Flush	B K M S Y H
DDK*	Kare / Square	Düz / Flush	B K M S Y H
DDX*	Dikdörtgen / Rectangle	Sinyal / Pilot Lights	B K M S Y H
DDY*	Yuvarlak / Round	Düz / Flush	B K M S Y H
DDYE30K	Yuvarlak / Round	Acil Stop / Emergency Stop	K
DDYM30*	Yuvarlak / Round	Mantar / Mushroom	B K M S Y H
DKX*	Kare / Square	Sinyal / Pilot Lights	K

Aksesuarlar / Accessories

Ürün Kodu Code	Tip Type
DA	Adaptör / Adapter

BOYUTLAR (mm) / DIMENSIONS (mm)

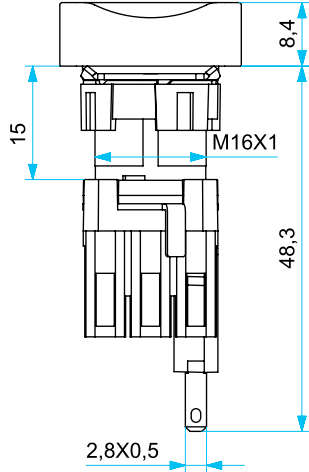

Dikdörtgen-Kare-Yuvarlak Buton
Rectangle-Square-Round Button

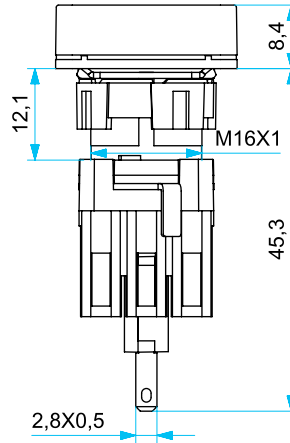

Dikdörtgen-Kare-Yuvarlak Led Buton
Rectangle-Square-Round LED Button

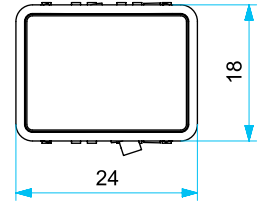

Dikdörtgen Buton
Rectangle Button

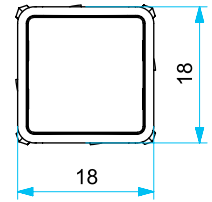

Kare Buton
Square Button

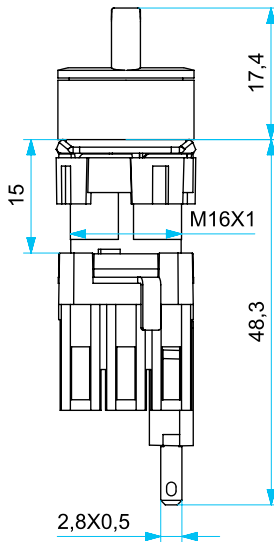
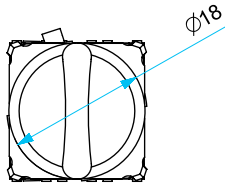

Seçici Buton
Selector Button

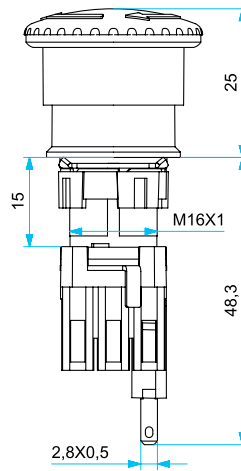
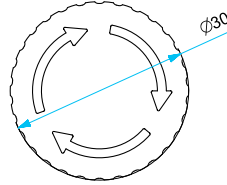

Emniyet Mantar Buton
Emergency Mushroom Button

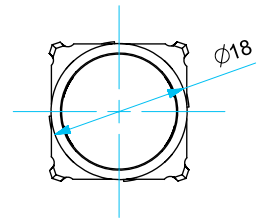

Yuvarlak Buton
Round Button



H Serisi Ø 30mm Kumanda Butonları

- Darbe dayanıklı polikarbonat buton lensi
- Alev almayan V0 PA6.6 kontak bloklar
- İstenildiğinde çeşitli ışıklı kontak blokların uygunluğu
- Adaptöre kontak blokların takılmasında alete ihtiyaç olmaması
- Led ışıkla, minimum ısınma maksimum ömür
- Arka arkaya 2 kontak blok takılabilir
- Tüm uygulamalara cevap verecek ürün çeşitliliği

Teknik Bilgiler

Mekanik Ömür	: 500.000 açma-kapama min.
Elektriksel Ömür	: 100.000 açma-kapama min.
Çalışma Sıcaklığı	: min./maks. °C -5/+40
Koruma Sınıfı	: IP50
Çalışma Sıklığı	: Yüzsüz .3000 açma-kapama/saat
	: Yükte 1.200 açma-kapama/saat
Çalışma Gerilimi (Ue)	: 250 V AC
Çalışma Akımı (Ie)	: 4 A
Yalıtım Gerilimi (Ui)	: 300 V
Darbe Dayanım Gerilimi (Uimp)	: 2.5 kV
Kısa Devre Kesme Kap. (Icn)	: 1 kA
İzolasyon Direnci	: 10 MΩ min. (500 V DC)
Kullanım Sınıfı	: AC15
Dielektrik Mukavemeti	: 1.500 V AC (1 dk. için)
Standart Kontak Malzemesi	: AgNi
Bağlantı Kablo Kesiti	: 1.5 - 2.5 mm ²
Standart	: UL 508 TS EN 60947-5-1 VDE0660



Kontakt Bloklarda

H Series Ø 30mm Control Units

- Impact-resistant polycarbonate button lens
- Non-flammable V0 PA6.6 contact blocks
- Various illumination contact blocks availability on request
- Tools not required to attach contact blocks to adapter
- With LED illumination, minimum warm-up and maximum lifetime
- Contact blocks can be stacked by two blocks deep
- Variety of products for all areas of application

Technical Information

Mechanical Life	: 500.000 operations min.
Electrical Life	: 100.000 operations min.
Operating Temperature	: min./max. °C -5/+40
Protection Degree	: IP50
Operating Frequency	: Without load 3000 operations/hour
	: At full load 1200 operations/hour
Operating Voltage (Ue)	: 250 V AC
Operating Current (Ie)	: 4 A
Insulation Voltage (Ui)	: 300 V
Impact Resistance (Uimp)	: 2.5 kV
Short Circuit Breaking Capacity (Icn)	: 1 kA
Insulation Resistance	: 10 MΩ min. (500 V DC)
Utilization Category	: AC15
Dielectric Strength	: 1.500 V AC (For 1 minute)
Standard Contact Material	: AgNi
Cable Section	: 1.5 - 2.5 mm ²
Standard	: UL 508 TS EN 60947-5-1 VDE0660



Contact Blocks

Kumanda Butonları ve Sinyal Lambaları Control Units and Pilot Lights



H Serisi Ø 30mm Kumanda Butonları Genel Şema

H Series Ø 30mm Control Units General Scheme

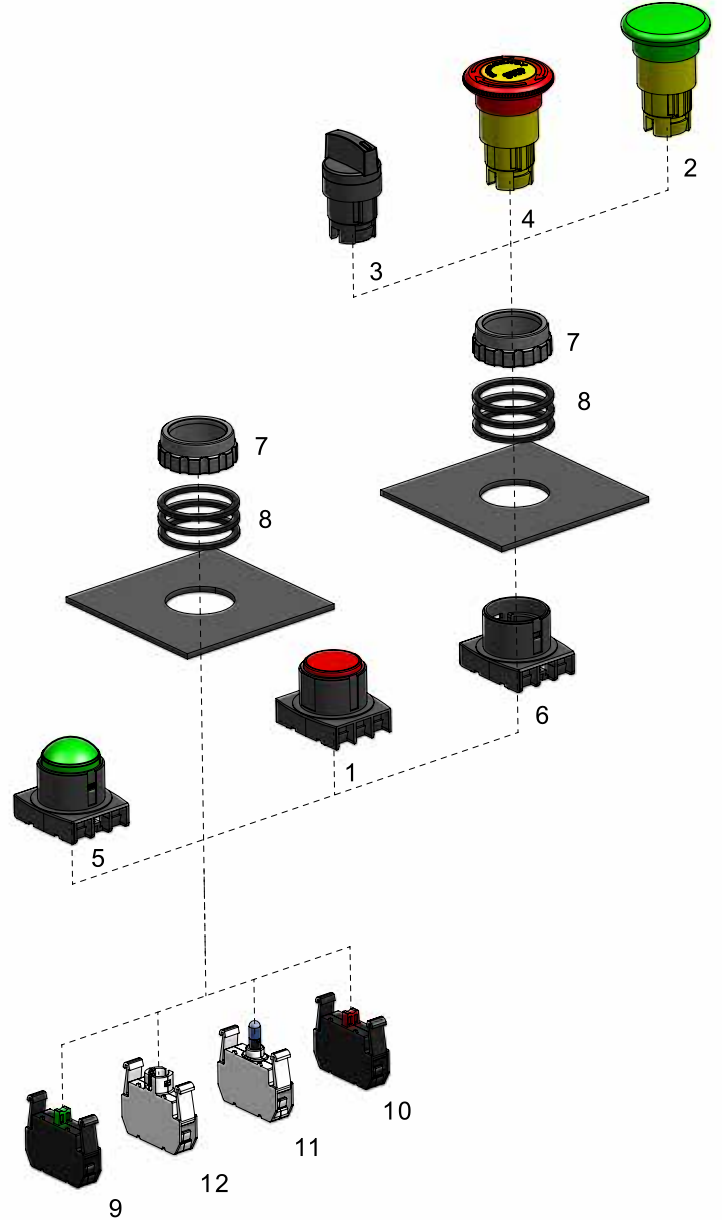

Yaylı Tip / Spring Type

- 1 D
- 2 M

Düz / Flush
Mantar, Ø 40 mm
Mushroom, Ø 40 mm

Seçici Tip / Selector Type

- 3 S

60° / 60°

Acil Stop / Emergency Stop Type

- 4 EE

Ø 40mm, Etiketli, Çevirmeli
Ø 40mm, With Label, Turn to Release

Sinyal / Pilots

- 5 X

Yuvarlak, Sinyal / Round, Pilots,

Aksesuarlar / Accessories

- 6 ADAPTÖR
- 7 SOMUN
- 8 CONTA
- 9 START KONTAKBLOK
- 10 STOP KONTAKBLOK
- 11 AMPULLU LED
- 12 LED KONTAKBLOK

Adaptör / Adapter
Plastik Somun / Plastic Nut
Mesafe Ayarlama Contası / Spacing Gasket
Kontakt Blok, Start (NA) / Contact Block, Start (NO)
Kontakt Blok, Stop (NK) / Contact Block, Stop (NC)
Ba9S Duyulu Işık Kontakt Blok / Lampholder for Ba9S Bulbs
Kontakt Blok, LED / Contact Block, LED

Kumanda Butonları ve Sinyal Lambaları

Control Units and Pilot Lights



H Serisi Kumanda Butonlar Seçim Tablosu

Series Control Units Selection Table

Seri	Kontakt Blok Kombinasyonu	Buton Tipi	Renk
H Series	1 K 2 Contact Block Combination	D Button Type	K Colour
Seri Series	Kontakt Blok Tipi Contact Block Type	Buton Tipi Button Type	Renk Colour
H Serisi Ø 30mm Kumanda Butonu Series Ø 30mm Control Units	0 Boş Empty 1 Start Butonluk Start For Button 2 Stop Butonluk Stop For Button	Yaylı Tip Spring Type D Düz Flush M Mantar Ø 40 mm Mushroom Ø 40 mm	B Beyaz White K Kırmızı Red M Mavi Blue S Sarı Yellow Y Yeşil Green H Siyah Black
Kontakt Blok Tipi Contact Block Type	0 Boş Empty 1 Start Butonluk Start For Button 2 Stop Butonluk Stop For Button	Seçici Tip Selector Type S20 2 Pozisyonlu Kalıcı 2 Position Stay Put (0-1) 60° S21 2 Pozisyonlu Dönümlü 2 Position Spring Return (0-1) 60° S30 3 Pozisyonlu Kalıcı 3 Position Stay Put (II-0-I) 60° S31 3 Pozisyonlu Tek Dönümlü 3 Position Single Spring Return (II-0-I) 60° S32 3 Pozisyonlu Çift Dönümlü 3 Position Double Spring Return (II-0-I) 60°	
Işık Bloğu Tipi Illumination Block Type	0 Boş Without Illumination 3 Işık Blok Illumination Block Ba9S Ampullere Uygun Duylu Suitable for Ba9S Bulbs 5 12 - 30V AC/DC Beyaz LED'li 12 - 30V AC/DC With White LED 6 12 - 30V AC/DC Kırmızı LED'li 12 - 30V AC/DC With Red LED 7 12 - 30V AC/DC Mavi LED'li 12 - 30V AC/DC With Blue LED 8 12 - 30V AC/DC Sarı LED'li 12 - 30V AC/DC With Yellow LED 9 12 - 30V AC/DC Yeşil LED'li 12 - 30V AC/DC With Green LED B 100 - 230V AC Beyaz LED'li 100 - 230V AC With White LED K 100 - 230V AC Kırmızı LED'li 100 - 230V AC With Red LED M 100 - 230V AC Mavi LED'li 100 - 230V AC With Blue LED S 100 - 230V AC Sarı LED'li 100 - 230V AC With Yellow LED Y 100 - 230V AC Yeşil LED'li 100 - 230V AC With Green LED Q Özel Gerilim Beyaz LED'li Special Voltage With White LED X Özel Gerilim Kırmızı LED'li Special Voltage With Red LED V Özel Gerilim Mavi LED'li Special Voltage With Blue LED W Özel Gerilim Sarı LED'li Special Voltage With Yellow LED Z Özel Gerilim Yeşil LED'li Special Voltage With Green LED	Acil Stop Tip Emergency Stop Type EE Ø 40mm Etiketli Çevirmeli Ø 40mm With Label Turn to Release	Sinyal Pilot Lights X Sinyal Pilot Lights
		Örnek: H1K2DK → H Serisi, start-stop, 100 - 230V AC, kırmızı LED'li, kırmızı renkli, Düz, buton seçilmiştir.	
		Example: H1K2DK → H Series, start-stop, 100 - 230V AC, with red LED Red, Flush button has been selected.	

Kumanda Butonları ve Sinyal Lambaları

Control Units and Pilot Lights



H Serisi Ø 30 mm Kumanda Buton Tipleri

Series Ø 30 mm Control Units Types

Yaylı Tip Kumanda Butonlar / Spring Type Control Units

Ürün Kodu	Kontakt Blok Tipi		Işık	Buton Tipi	Renk
Code	Contact Block Type		Illumination	Button Type	Colour
	Normal Açık Normally Open	Normal Kapalı Normally Closed	Opsiyonel Optional		
H100D*	1	-	√	Düz / Flush	
H101D*	2	-	√	Düz / Flush	
H102D*	1	1	√	Düz / Flush	
H200D*	-	1	√	Düz / Flush	
H202D*	-	2	√	Düz / Flush	
H102M*	1	1	-	Mantar / Mushroom	
H200M*	-	1	-	Mantar / Mushroom	
H202M*	-	2	-	Mantar / Mushroom	



H100DY



H200DK

Seçici Tip Kumanda Butonları / Selector Type Control Units

Ürün Kodu	Kontakt Blok Tipi		Işık	Etiket	Buton Tipi	Pozisyon	Renk
Code	Contact Block Type		Illumination	Button Plates	Button Type	Position	Colour
	Normal Açık Normally Open	Normal Kapalı Normally Closed	LED LED				
H100S20	1	-	-	0-I	Seçici / Selector	2 Pozisyonlu-Kalıcı-60° / 2 Position-Stay Put-60°	
H101S20	2	-	-	0-I	Seçici / Selector	2 Pozisyonlu-Kalıcı-60° / 2 Position-Stay Put-60°	
H102S20	1	1	-	0-I	Seçici / Selector	2 Pozisyonlu-Kalıcı-60° / 2 Position-Stay Put-60°	
H100S21	1	-	-	0-I	Seçici / Selector	2 Pozisyonlu-Dönüşlü-60° / 2 Position-Spring Return-60°	
H101S21	2	-	-	0-I	Seçici / Selector	2 Pozisyonlu-Dönüşlü-60° / 2 Position-Spring Return-60°	
H102S21	1	1	-	0-I	Seçici / Selector	2 Pozisyonlu-Dönüşlü-60° / 2 Position-Spring Return-60°	
H101S30	2	-	-	II-0-I	Seçici / Selector	3 Pozisyonlu-Kalıcı -60° / 3 Position-Stay Put-60°	
H102S30	1	1	-	II-0-I	Seçici / Selector	3 Pozisyonlu-Kalıcı -60° / 3 Position-Stay Put-60°	
H101S31	2	-	-	II-0-I	Seçici / Selector	3 Pozisyonlu-Tek Dönüşlü-60° / 3 Position-Single Spring Return-60°	
H102S31	1	1	-	II-0-I	Seçici / Selector	4 Pozisyonlu-Tek Dönüşlü-60° / 3 Position-Single Spring Return-60°	
H101S32	2	-	-	II-0-I	Seçici / Selector	3 Pozisyonlu-Çift Dönüşlü -60° / 3 Position-Double Spring Return-60°	
H102S32	1	1	-	II-0-I	Seçici / Selector	3 Pozisyonlu-Çift Dönüşlü-60° / 3 Position-Double Spring Return-60°	

Kumanda Butonları ve Sinyal Lambaları

Control Units and Pilot Lights



Acil Stop Tip Kumanda Butonları / Emergency Stop Type Control Units

Ürün Kodu	Kontakt Blok Tipi	Etiket	Tip	Çap (mm)	Renk
Code	Contact Block Type	Button Plates	Type	Dia (mm)	Colour
H200E	-	1	Çevirmeli / Turn to Release	Ø 40mm	K
H200EE	-	1	Etiketli - Çevirmeli / With Label - Turn to Release	Ø 40mm	K

Normal Açık
Normally Open

Normal Kapalı
Normally Closed



H200EE

Sinyaller / Pilot Lights

Ürün Kodu	Işık	Nominal Gerilim	Renk
Code	Illumination	Nominal Voltage	Colour
H030X*	Ba9S Duyulu		B K M S Y H
H050XB	LED	12 - 30V AC/DC	B
H060XK	LED	12 - 30V AC/DC	K
H070XM	LED	12 - 30V AC/DC	M
H080XS	LED	12 - 30V AC/DC	S
H090XY	LED	12 - 30V AC/DC	Y
H0B0XB	LED	100 - 230V AC	B
H0K0XK	LED	100 - 230V AC	K
H0M0XM	LED	100 - 230V AC	M
H0S0XS	LED	100 - 230V AC	S
H0Y0XY	LED	100 - 230V AC	Y



H060XK



H050XS



H090XY

Kumanda Butonları ve Sinyal Lambaları

Control Units and Pilot Lights



H Serisi Ø 30 mm Kumanda Buton Tipleri

Series Ø 30 mm Control Units Types

Kontakt Blok Tipler / Contact Block Types

Ürün Kodu	Kontakt Blok Tipi	Işık	Nominal Akım	Nominal Gerilim	Renk
Code	Contact Block Type	Illumination	Nominal Current	Nominal Voltage	Colour
B1	1	-	4A	250V	-
B2	1	-	4A	250V	-
B3		Ba9S Duyulu	-	-	-
B5		LED	5-20mA	12-30V AC/DC	B
B6		LED	5-20mA	12-30V AC/DC	K
B7		LED	5-20mA	12-30V AC/DC	M
B8		LED	5-20mA	12-30V AC/DC	S
B9		LED	5-20mA	12-30V AC/DC	Y
BB		LED	5-15mA	100-230V AC	B
BK		LED	5-15mA	100-230V AC	K
BM		LED	5-15mA	100-230V AC	M
BS		LED	5-15mA	100-230V AC	S
BY		LED	5-15mA	100-230V AC	Y
BB4		LED	4-5mA	110V AC/DC	B
BK4		LED	4-5mA	110V AC/DC	K
BM4		LED	4-5mA	110V AC/DC	M
BS4		LED	4-5mA	110V AC/DC	S
BY4		LED	4-5mA	110V AC/DC	Y



B1



B2



B3



B9

H100DY

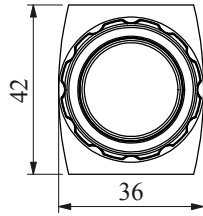
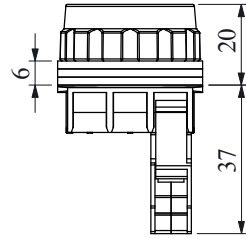

H100S20

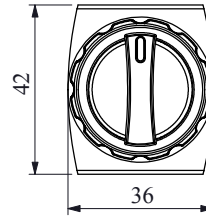
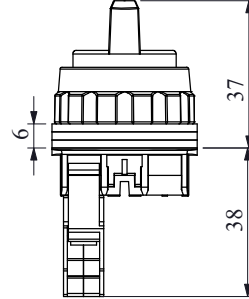

H200EE

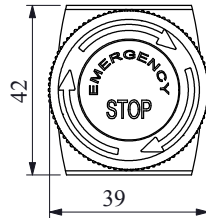
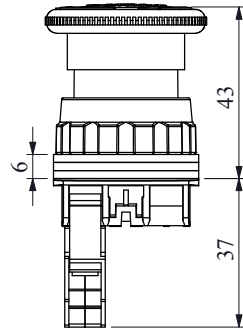

H050XB

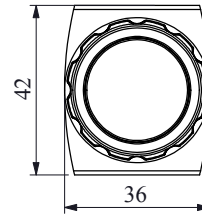
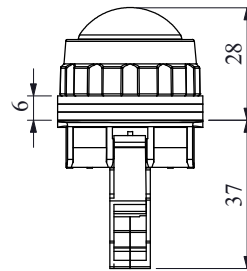

Montaj Ölçüsü / Mounting Measures

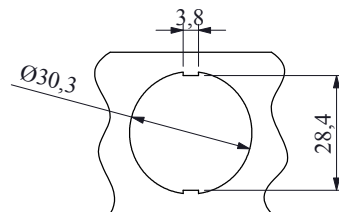



MB Monoblok Serisi Ø 22mm Kumanda Butonları

- Maksimum güvenlik için parmak koruma
- Darbe dayanıklı polikarbonat buton lensi
- Farklı dillerde ve özel işaretli çeşitli markalama etiketleri
- Tüm uygulamalara cevap verecek ürün çeşitliliği
- Yekpare sağlam gövde

Teknik Bilgiler

Mekanik Ömür	: 300.000 açma-kapama min.
Elektriksel Ömür	: 100.000 açma-kapama min.
Çalışma Sıcaklığı	: min./maks. °C -5/+40
Koruma Sınıfı	: IP50
Çalışma Sıklığı	: Yüksüz 3.000 açma-kapama/saat
	: Yükte 1.200 açma-kapama/saat
Çalışma Gerilimi (Ue)	: 240 V AC
Çalışma Akımı I(e)	: 3 A
Yalıtım Gerilimi (Ui)	: 250 V
Darbe Dayanım Gerilimi Uimp	: 2.5 kV
Anma Kesme Kapasitesi AC 15	: 1 kA
İzolasyon Direnci	: 10 MΩ min. (500 V DC)
Kullanım Sınıfı	: AC15
Dielektrik Mukavemeti	: 1.500 V AC (1 dk. için)
Standart Kontak Malzemesi	: AgNi
Bağlantı Kablo Kesiti	: 1.5 - 2.5 mm ²
Standart	: UL 508 TS EN 60947-5-1 VDE0660



MB Monoblock Series Ø 22mm Control Units

- Finger safe protection for maximum safety
- Impact-resistant polycarbonate button lens
- Various legend plates with different languages and custom markings
- Variety of products for all areas of application
- Monoblock strong body

Technical Information

Mechanical Life	: 300.000 operations min.
Electrical Life	: 100.000 operations min.
Operating Temperature	: min./max. °C -5/+40
Protection Degree	: IP50
Operating Frequency	: Without load 3.000 operations/hour
	: At full load 1.200 operations/hour
Operating Voltage (Ue)	: 240 V AC
Operating Current (Ie)	: 3 A
Insulation Voltage (Ui)	: 250 V
Impact Resistance (Uimp)	: 2.5 kV
Short Circuit Breaking Capacity (Icn)	: 1 kA
Insulation Resistance	: 10 MΩ min. (500 V DC)
Utilization Category	: AC15
Dielectric Strength	: 1.500 V AC (For 1 minute)
Standard Contact Material	: AgNi
Cable Section	: 1.5 - 2.5 mm ²
Standard	: UL 508 TS EN 60947-5-1 VDE0660



Kumanda Butonları ve Sinyal Lambaları Control Units and Pilot Lights



MB Monoblok Serisi Ø 22mm Kumanda Butonlar Genel Şema MB Monoblock Series Ø 22mm Control Units General Scheme

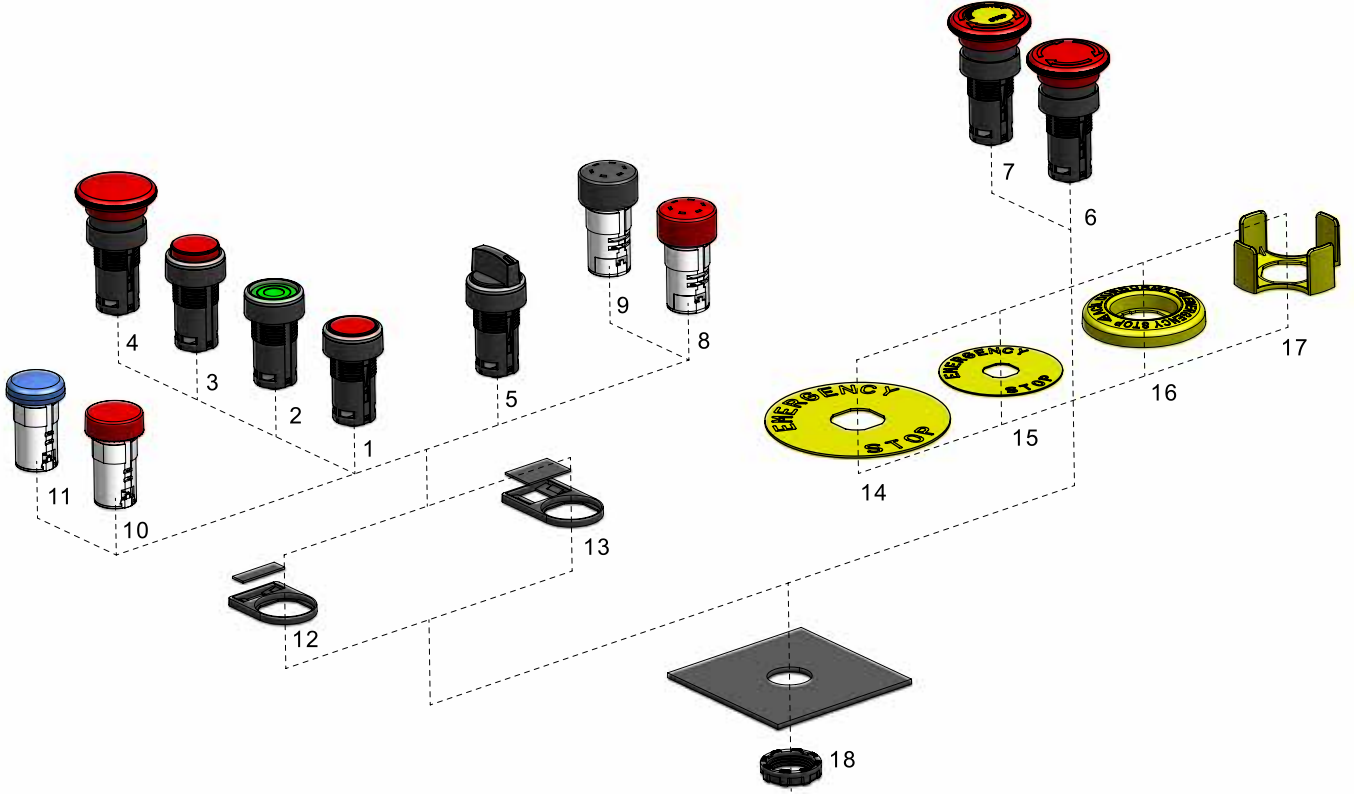

Yaylı Tip / Spring Type

- | | | |
|---|---|-------------------------------------|
| 1 | D | Düz / Flush |
| 2 | F | Kalıcı / Stay Put |
| 3 | H | Çıkık / Extended |
| 4 | M | Mantar, Ø 40 mm / Mushroom, Ø 40 mm |

Seçici Tip / Selector Type

- | | | |
|---|---|-----------|
| 5 | S | 60° / 60° |
|---|---|-----------|

Acil Stop / Emergency Stop Type

- | | | |
|---|----|---|
| 6 | E | Ø 40mm, Çevirmeli / Ø 40mm, Turn to Release |
| 7 | EE | Ø 40mm, Etiketli, Çevirmeli / Ø 40mm, With Label, Turn to Release |

Buzzer / Buzzer

- | | | |
|---|----|--------------------------------|
| 8 | ZS | Işıklı / Illuminated |
| 9 | ZX | Işıksız / Without Illumination |

Sinyal / Pilots

- | | | |
|----|----|--|
| 10 | SD | Düz, LED, Sinyal / Flat, LED, Pilots, |
| 11 | SP | Petekli, LED, Sinyal / Cellular, LED, Pilots |

Aksesuarlar / Accessories

- | | | |
|----|-----------|--|
| 12 | BROZET08 | Rozet, 8mm / Legend Plate Holder, 8mm |
| 13 | BROZET18 | Rozet, 18mm / Legend Plate Holder, 18mm |
| 14 | BET90A/P | Etiket, Ø90mm Acil Stop, Alüminyum / Plastik / Legend Plate, Ø90mm Emergency Stop, Aluminium / Plastic |
| 15 | BET60A/P | Etiket, Ø60mm Acil Stop, Alüminyum / Plastik / Legend Plate, Ø60mm Emergency Stop, Aluminium / Plastic |
| 16 | BET60LED | Etiket, Ø60mm Acil Stop, LED / LED Illuminated Legend Plate, Ø60mm Emergency Stop |
| 17 | BMUHAFAZA | Emniyet Koruma / Emergency Protective Cover |
| 18 | SOMUN | Plastic Somun, M22 X 1,5 / Plastic Nut, M22 X 1,5 |

Kumanda Butonları ve Sinyal Lambaları

Control Units and Pilot Lights



MB Serisi Monoblok Kumanda Butonlar Seçim Tablosu

Series Monoblock Control Units Selection Table

Seri	Kontakt Blok Kombinasyonu	Buton Tipi	Renk	Yazı
MB Series	1 0 2 Contact Block Combination	D Button Type	K Colour	1 Pad Printing
Seri Series MB Serisi Monoblok Ø 22mm Kumanda Butonu Series Monoblock Ø 22mm Control Units	Kontakt Blok Tipi Contact Block Type 1 Start Butonluk Start For Button 2 Stop Butonluk Stop For Button	Buton Tipi Button Type Yaylı Tip Spring Type D Düz Flush F Kalıcı Stay Put H Çıkık Extended M Mantar Mushroom Ø 40 mm Ø 40 mm	Renk Colour B Beyaz White K Kırmızı Red M Mavi Blue S Sarı Yellow Y Yeşil Green H Siyah Black	Yazı Pad Printing 0 0 0 10 I-0 I-0 1 I I 2 II II 12 I-II I-II L LIGHT LIGHT OD OK Vertical Arrow OY OK Horizontal Arrow OK OK Special Arrow OO OK Special Arrow S Siren İşareti Siren Symbol Z Zil İşareti Bell Symbol
Kontakt Blok Tipi Contact Block Type 1 Start Butonluk Start For Button 2 Stop Butonluk Stop For Button	Işık Bloğu Tipi Illumination Block Type 0 Boş Without Illumination	Seçici Tip Selector Type S20 2 Pozisyonlu Kalıcı 2 Position Stay Put (0-1) 60° S21 2 Pozisyonlu Dönüşlü 2 Position Spring Return (0-1) 60° S30 3 Pozisyonlu Kalıcı 3 Position Stay Put (II-0-I) 60° S31 3 Pozisyonlu Tek Dönüşlü 3 Position Single Spring Return (II-0-I) 60° S32 3 Pozisyonlu Çift Dönüşlü 3 Position Double Spring Return (II-0-I) 60°	Acil Stop Tip Emergency Stop Type E Ø 40mm Çevirmeli Ø 40mm Turn to Release EE Ø 40mm Etiketli Çevirmeli Ø 40mm With Label Turn to Release	Sinyal Pilot Lights X Sinyal Pilot Lights
			Yazılı Printed Dikey Yazılı Printed Yatay Yazılı Printed Özel Yazılı Printed Özel Yazılı Printed 	

H1K2DK → H Serisi, start-stop, 100 - 230V AC, kırmızı LEDli, kırmızı renkli, Düz, buton seçilmiştir.

Örnek: MB102DK → MB Monoblok serisi, start-stop, kırmızı renkli, Düz Buton seçilmiştir.

Example: MB102DK → MB Monoblock series, start-stop, red, Flush Button has been selected.

Kumanda Butonları ve Sinyal Lambaları

Control Units and Pilot Lights



Yaylı Tip Kumanda Butonları / Spring Type Control Units

Ürün Kodu	Kontakt Blok Tipi		Buton Tipi	Renk
Code	Contact Block Type		Button Type	Colour
	Normal Açık Normally Open	Normal Kapalı Normally Closed		
MB100D*	1	-	Düz / Flush	
MB101D*	2	-	Düz / Flush	
MB102D*	1	1	Düz / Flush	
MB200D*	-	1	Düz / Flush	
MB202D*	-	2	Düz / Flush	
MB100F*	1	-	Kalıcı / Stay Put	
MB101F*	2	-	Kalıcı / Stay Put	
MB102F*	1	1	Kalıcı / Stay Put	
MB200F*	-	1	Kalıcı / Stay Put	
MB202F*	-	2	Kalıcı / Stay Put	
MB100H*	1	-	Çıkık / Extended	
MB101H*	2	-	Çıkık / Extended	
MB102H*	1	1	Çıkık / Extended	
MB200H*	-	1	Çıkık / Extended	
MB202H*	-	2	Çıkık / Extended	
MB100M*	1	-	Mantar / Mushroom	
MB101M*	2	-	Mantar / Mushroom	
MB102M*	1	1	Mantar / Mushroom	
MB200M*	-	1	Mantar / Mushroom	
MB202M*	-	2	Mantar / Mushroom	



MB102DM



MB100DY



MB200MK



MB100FY



MB100HY

Seçici Tip Kumanda Butonları / Selector Type Control Units

Ürün Kodu	Kontakt Blok Tipi		Işık	Etiket	Buton Tipi	Pozisyon	Renk
Code	Contact Block Type		Illumi- nation	Button Plates	Button Type	Position	Colour
	Normal Açık Normally Open	Normal Kapalı Normally Closed	LED LED				
MB100S20	1	-	-	0-I	Seçici / Selector	2 Pozisyonlu-Kalıcı-60° / 2 Position-Stay Put-60°	
MB101S20	2	-	-	0-I	Seçici / Selector	2 Pozisyonlu-Kalıcı-60° / 2 Position-Stay Put-60°	
MB102S20	1	1	-	0-I	Seçici / Selector	2 Pozisyonlu-Kalıcı-60° / 2 Position-Stay Put-60°	
MB100S21	1	-	-	0-I	Seçici / Selector	2 Pozisyonlu-Dönüşlü-60° / 2 Position-Spring Return-60°	
MB101S21	1	1	-	0-I	Seçici / Selector	2 Pozisyonlu-Dönüşlü-60° / 2 Position-Spring Return-60°	
MB101S30	2	-	-	II-0-I	Seçici / Selector	3 Pozisyonlu-Kalıcı -60° / 3 Position-Stay Put-60°	
MB101S31	2	-	-	II-0-I	Seçici / Selector	3 Pozisyonlu-Tek Dönüşlü-60° / 3 Position-Single Spring Return-60°	
MB101S32	2	-	-	II-0-I	Seçici / Selector	3 Pozisyonlu-Çift Dönüşlü -60° / 3 Position-Double Spring Return-60°	



MB100S20

Kumanda Butonları ve Sinyal Lambaları

Control Units and Pilot Lights



MB Serisi Monoblok Ø 22 mm Kumanda Buton Tipleri

Series Monoblock Ø 22 mm Control Units Types

Acil Stop Tip Kumanda Butonları / Emergency Stop Type Control Units

Ürün Kodu	Kontakt Blok Tipi	Etiket	Tip	Çap (mm)	Renk
Code	Contact Block Type	Button Plates	Type	Dia (mm)	Colour
	 Normal Açık Normally Open	 Normal Kapalı Normally Closed			
MB100E	1	-	Çevirmeli / Turn to Release	Ø 40mm	K
MB102E	1	1	Çevirmeli / Turn to Release	Ø 40mm	K
MB200E	-	1	Çevirmeli / Turn to Release	Ø 40mm	K
MB202E	-	2	Çevirmeli / Turn to Release	Ø 40mm	K
MB100EE	1	-	✓ Etiketli - Çevirmeli / With Label - Turn to Release	Ø 40mm	K
MB102EE	1	1	✓ Etiketli - Çevirmeli / With Label - Turn to Release	Ø 40mm	K
MB200EE	-	1	✓ Etiketli - Çevirmeli / With Label - Turn to Release	Ø 40mm	K
MB202EE	-	2	✓ Etiketli - Çevirmeli / With Label - Turn to Release	Ø 40mm	K



MB200E



MB200EE

Buzzerlar / Buzzers

Ürün Kodu	Işık	Özellik	Nominal Gerilim	Özellik	Renk
Code	Illumination	Features	Nominal Voltage	Features	Colour
MBZX012S	LED	IP40	12V AC/DC	90 db (10cm uzaklıkta) Sabit / 90 db (10cm distance) Single Melody	K
MBZS024S	LED	IP40	24V AC/DC	90 db (10cm uzaklıkta) Sabit / 90 db (10cm distance) Single Melody	K
MBZS024SE	LED	IP65	24V AC/DC	85 db (10cm uzaklıkta) Sabit / 85db (10cm distance) Single Melody	K
MBZS110S	LED	IP40	110V AC	90 db (10cm uzaklıkta) Sabit / 90 db (10cm distance) Single Melody	K
MBZS220S	LED	IP40	220V AC	90 db (10cm uzaklıkta) Sabit / 90 db (10cm distance) Single Melody	K
MBZS220SE	LED	IP65	220V AC	85 db (10cm uzaklıkta) Sabit / 85db (10cm distance) Single Melody	K
MBZX024S	LED	IP40	24V AC/DC	90 db (10cm uzaklıkta) Sabit / 90 db (10cm distance) Single Melody	K
MBZX024SE	LED	IP65	24V AC/DC	85 db (10cm uzaklıkta) Sabit / 85db (10cm distance) Single Melody	K
MBZX110S		IP40	110V AC	90 db (10cm uzaklıkta) Sabit / 90 db (10cm distance) Single Melody	H
MBZX220S		IP40	220V AC	90 db (10cm uzaklıkta) Sabit / 90 db (10cm distance) Single Melody	H
MBZX220SE		IP65	220V AC	85 db (10cm uzaklıkta) Sabit / 85db (10cm distance) Single Melody	H

- IP65 istendiğinde sonuna "E" harfi eklenmektedir. Ses 5 desibel düşmektedir.
- For IP65 preferences, please add "E" letter to end of the code. In case of IP65 preferences, volume has been decreased 5 db.



MBZS024S



MBZX220S

Kumanda Butonları ve Sinyal Lambaları

Control Units and Pilot Lights



Sinyaller / Pilot Lights

Ürün Kodu	Işık	Özellik	Nominal Gerilim	Renk
Code	Illumination	Features	Nominal Voltage	Colour
MBSD012*	LED	Düz / Flat	12V AC/DC	B K M S Y H
MBSD024*	LED	Düz / Flat	24V AC/DC	B K M S Y H
MBSD110*	LED	Düz / Flat	110V AC	B K M S Y H
MBSD220*	LED	Düz / Flat	220V AC	B K M S Y H
MBSP012*	LED	Petekli / Cellular	12V AC/DC	B K M S Y H
MBSP024*	LED	Petekli / Cellular	24V AC/DC	B K M S Y H
MBSP110*	LED	Petekli / Cellular	110V AC	B K M S Y H
MBSP220*	LED	Petekli / Cellular	220V AC	B K M S Y H



MBSD024Y



MBSP220M

Özel Tampon Baskılı Butonlar / Special Pad Printed Control Units

Ürün Kodu / Code	MB100DY-0D	MB100DY-0Y	MB100DH-0D	MB100DH-0Y	MB100DB-0D	MB100DB-0Y	MB100DB-Z	MB100DB-L
Baskı / Print	Dikey Oklu Vertical Arrow	Yatay Oklu Horizontal Arrow	Dikey Oklu Vertical Arrow	Yatay Oklu Horizontal Arrow	Dikey Oklu Vertical Arrow	Yatay Oklu Horizontal Arrow	Zil / Bell	Lamba / Lamp
Ürün Kodu / Code	MB100DY-1	MB100DY-2	MB100DB-1	MB100DB-2	MB200DK-0	MB200DH-0	MB200DS-Z	MB200DS-L
Baskı / Print	I	II	I	II	O	O	Zil / Bell	Lamba / Lamp

Aksesuarlar / Accessories

Ürün Kodu	Tip	Özellik
Code	Type	Features
BPUL	Pul / Plate	Buton Sıkıştırma / Button Tightening
BSOMAN	Somun Anahtar / Nut Tightener	

Kumanda Butonları ve Sinyal Lambaları

Control Units and Pilot Lights



BOYUTLAR (mm) / DIMENSIONS (mm)

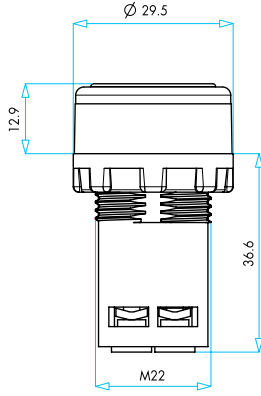

Düz Kafalı Yaylı Buton
Flush, Spring Return

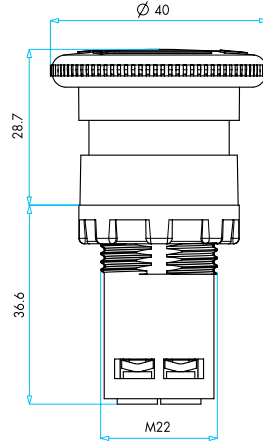

40 mm Acil Stop Butonu
40 mm Emergency Stop

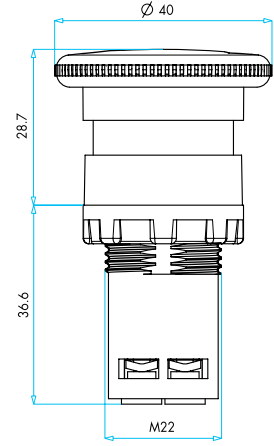

40 mm Mantar Buton
40 mm Mushroom Button

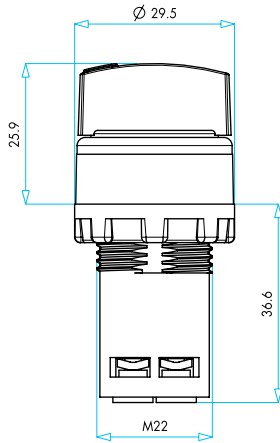

Seçici Buton
Selector Switch

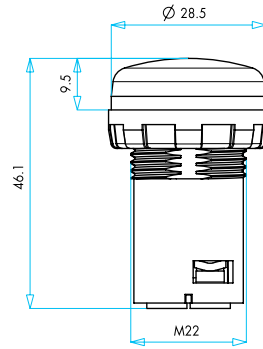

Sinyal (Petekli Cam)
Signal (Comb Glass)

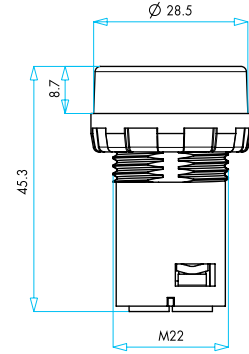

Sinyal (Düz Cam)
Signal (Flat Glass)

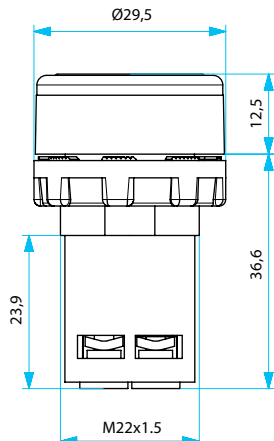

Monoblok Kalıcı Buton
Monoblock Stay-Put Button

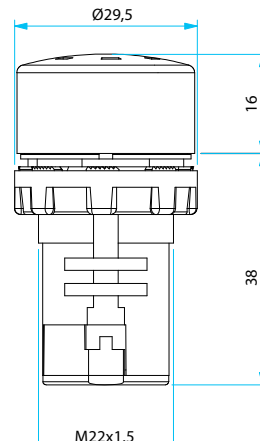

Monoblok Buzzer
Monoblock Buzzer



KB Serisi Ø 22mm Kumanda Butonları

- Darbe dayanıklı polikarbonat buton lensi
- Alev almayan VO PA6.6 kontak bloklar
- Farklı dillerde ve özel işaretli çeşitli markalama etiketleri
- Tüm uygulamalara cevap verecek ürün çeşitliliği
- 1980'den beri güvenle kullanılan tasarım

Teknik Bilgiler

Mekanik Ömür	: 500.000 açma-kapama min.
Elektriksel Ömür	: 100.000 açma-kapama min.
Çalışma Sıcaklığı	: min./maks. °C -5/+40
Koruma Sınıfı	: IP50
Çalışma Sıklığı	: Yüksüz 3.000 açma-kapama/saat
	: Yükte 1.200 açma-kapama/saat
Anma İşletme Gerilimi (Ue)	: 220 V AC
Anma İşletme Akımı (Ie)	: 4 A
Yalıtım Gerilimi (Ui)	: 300 V
Darbe Dayanım Gerilimi (Uimp)	: 2.5 kV
Anma Kesme Kapasitesi AC 15	: 1 kA
İzolasyon Direnci	: 10 MΩ min. (500 V DC)
Kullanım Sınıfı	: AC15
Dielektrik Mukavemeti	: 1.500 V AC (1 dk. için)
Standart Kontak Malzemesi	: AgNi
Bağlantı Kablo Kesiti	: 1.5 - 2.5 mm ²
Standart	: UL 508 TS EN 60947-5-1 VDE0660



KB Series Ø 22mm Control Units

- Impact-resistant polycarbonate button lens
- Non-flammable VO PA6.6 contact blocks
- Various legend plates with different languages and custom markings
- Variety of products for all areas of application
- Reliable design since 1980

Technical Information

Mechanical Life	: 500.000 operations min.
Electrical Life	: 100.000 operations min.
Operating Temperature	: min./max. °C -5/+40
Protection Degree	: IP50
Operating Frequency	: Without load 3.000 operations/hour
	: At full load 1.200 operations/hour
Operating Voltage (Ue)	: 220 V AC
Operating Current (Ie)	: 4 A
Insulation Voltage (Ui)	: 300 V
Impact Resistance (Uimp)	: 2.5 kV
Short Circuit Breaking Capacity (Icn)	: 1 kA
Insulation Resistance	: 10 MΩ min. (500 V DC)
Utilization Category	: AC15
Dielectric Strength	: 1.500 V AC (For 1 minute)
Standard Contact Material	: AgNi
Cable Section	: 1.5 - 2.5 mm ²
Standard	: UL 508 TS EN 60947-5-1 VDE0660



Kumanda Butonları ve Sinyal Lambaları

Control Units and Pilot Lights



KB Serisi Ø 22mm Kumanda Butonları Genel Şema

KB Series Ø 22mm Control Units General Scheme

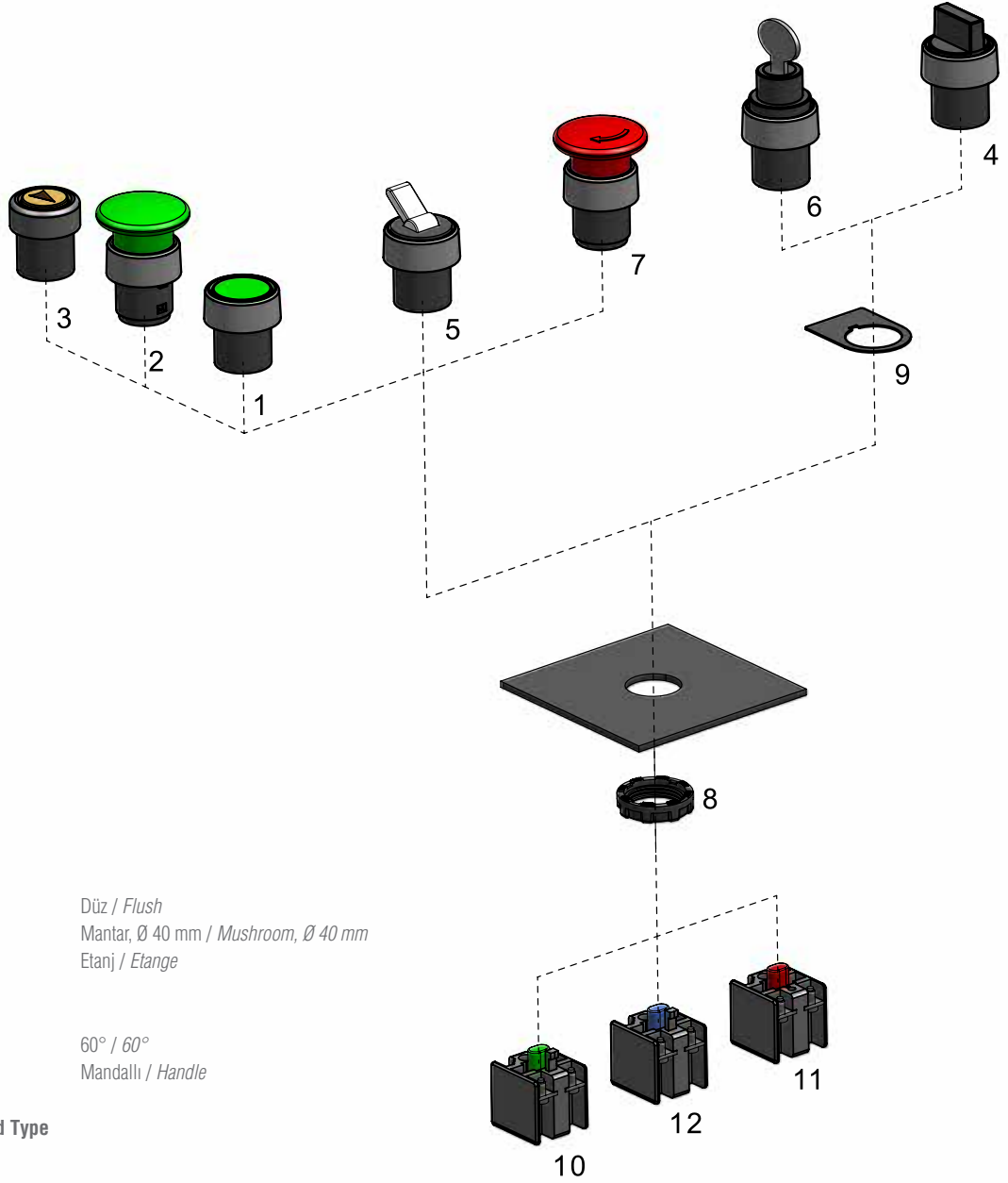

Yaylı Tip / Spring Type

- 1 D Düz / Flush
2 M Mantar, Ø 40 mm / Mushroom, Ø 40 mm
3 R Etanj / Etange

Seçici Tip / Selector Type

- 4 S2 60° / 60°
5 C Mandallı / Handle

Anahtarlı Tip / Key Operated Type

- 6 A2

Acil Stop / Emergency Stop Type

- 7 E Ø 40mm, Çevirmeli / Ø 40mm, Turn to Release

Aksesuarlar / Accessories

- 8 SOMUN Plastic Somun, M22 X 1,5 / Plastic Nut, M22 X 1,5
9 ROZET Rozet, KB Buton / Legend Plate Holder, KB Buton
10 START KONTAKBLOK Kontak Blok, Start (NA) / Contact Block, Start (NO)
11 STOP KONTAKBLOK Kontak Blok, Stop (NK) / Contact Block, Stop (NC)
12 START-STOP KONTAK BLOK Kontak Blok, Start-Stop (NA+NK) / Contact Block, Start-Stop (NO+NC)

Kumanda Butonları ve Sinyal Lambaları

Control Units and Pilot Lights



KB Serisi Kumanda Butonlar Seçim Tablosu

Series Control Units Selection Table

Seri	Kontakt Tipi	Buton Tipi	Renk	Yazı
KB Series	12 Contact Block Type	D Button Type	K Colour	1 Pad Printing
Seri Series KB Serisi Ø 22mm Kumanda Butonu Series Ø 22mm Control Units	Kontakt Blok Tipi Contact Block Type 12 Stop Stop 14 Çift Devre Double Circuit 34 Start Start	Buton Tipi Button Type Yaylı Tip Spring Type D Düz Flush M Mantar Ø40 mm Mushroom Ø 40 mm R Etanj Etange Seçici Tip Selector Type S2 2 Pozisyonlu Kalıcı 2 Position Stay Put C Mandallı Handle Anahtarlı Tip Key Operated Type A2 2 Pozisyonlu 0 Pozisyonunda Anahtarı Çıkan Kalıcı 2 Position Key Removal at 0 position Stay Put Acil Stop Tip Emergency Stop Type E Ø 40mm Çevirmeli Ø 40mm Turn to Release	Renk Colour B Beyaz White K Kırmızı Red M Mavi Blue S Sarı Yellow Y Yeşil Green H Siyah Black 0 0 Yazılı 0 Printed	Yazı Pad Printing 0 0 Yazılı 0 Printed

Örnek: KB12DK → KB Serisi Stop, Düz kırmızı buton seçilmiştir.

Example: KB12DK → KB Series, Stop, Flush, Red button has been selected.

Kumanda Butonları ve Sinyal Lambaları

Control Units and Pilot Lights



KB Serisi Ø 22 mm Kumanda Buton Tipleri

Series Ø 22 mm Control Units Types

Yaylı Tip Kumanda Butonlar / Spring Type Control Units

Ürün Kodu Code	Kontakt Blok Tipi Contact Block Type	Işık Illumination	Buton Tipi Button Type	Renk Colour
	Normal Açık Normally Open	Normal Kapalı Normally Closed		
KB12D*		-	Düz / Flush	
KB14D*	1	1	Düz / Flush	
KB34D*	1	-	Düz / Flush	
KB12M*		1	Mantar / Mushroom	
KB14M*	1	1	Mantar / Mushroom	
KB34M*	1	-	Mantar / Mushroom	
KB12R*		1	Etanj / Etange	
KB14R*	1	1	Etanj / Etange	
KB34R*	1	-	Etanj / Etange	
KB12RB-0		1	Etanj Oklu / Etange	
KB14RB-0	1	1	Etanj Oklu / Etange	
KB34RB-0	1	-	Etanj Oklu / Etange	



KB34DY



KB12C

Seçici Tip Kumanda Butonları / Selector Type Control Units

Ürün Kodu Code	Kontakt Blok Tipi Contact Block Type	Işık Illumination	Etiket Button Plates	Buton Tipi Button Type	Pozisyon Position	Renk Colour	
	Normal Açık Normally Open	Normal Kapalı Normally Closed	LED LED				
KB14S2	1	1	-	0-I	Seçici / Selector	2 Pozisyonlu-Kalıcı-60° / 2 Position-Stay Put-60°	
KB34S2	1	-	-	0-I	Seçici / Selector	2 Pozisyonlu-Kalıcı-60° / 2 Position-Stay Put-60°	
KB12C	-	1	-	0-I	Mandallı / Handle Switch		
KB14C	1	1	-	0-I	Mandallı / Handle Switch		
KB34C	1	-	-	0-I	Mandallı / Handle Switch		





KB34S2

Kumanda Butonları ve Sinyal Lambaları

Control Units and Pilot Lights







Anahtarlı Tip Kumanda Butonları / Key Operated Type Control Units

Ürün Kodu	Kontakt Blok Tipi		Etiket	Tip	Pozisyon	Anahtar Çıkma Pozisyonu
Code	Contact Block Type		Button Plates	Type	Position	Key Removal Position
	 Normal Açık Normally Open	 Normal Kapalı Normally Closed				
KB14A2	1	1	(0-1)	Kalıcı / Stay Put	2 Pozisyonlu / 2 Position	0
KB34A2	1	-	(0-1)	Kalıcı / Stay Put	2 Pozisyonlu / 2 Position	0



KB14A2

Acil Stop Tip Kumanda Butonları / Emergency Stop Type Control Units

Ürün Kodu	Kontakt Blok Tipi		Tip	Çap (mm)	Renk
Code	Contact Block Type		Type	Dia (mm)	Colour
	 Normal Açık Normally Open	 Normal Kapalı Normally Closed			
KB12E	-	1	Çevirmeli / Turn to Release	Ø 40mm	
KB14E	1	1	Çevirmeli / Turn to Release	Ø 40mm	





KB12E

Kumanda Butonları ve Sinyal Lambaları Control Units and Pilot Lights





Kontak Blok Tipler / Contact Block Types

Ürün Kodu Code	Kontak Blok Tipi Contact Block Type	Nominal Akım Nominal Current	Nominal Gerilim Nominal Voltage	Kullanım Yeri	
	 Normal Açık Normally Open	 Normal Kapalı Normally Closed			
KB12	-	1	4A	220V	Butonluk / For Control Units
KB14B	1	1	4A	220V	Butonluk / For Control Units
KB14K	1	1	4A	220V	Kutuluk / For Boxes
KB34B	1	-	4A	220V	Butonluk / For Control Units
KB34K	1	-	4A	220V	Kutuluk / For Boxes



KB12

Yedekler / Spare Parts

Ürün Kodu Code	Nominal akım Nominal Current	Buton Tipi Control Unit Types	Pozisyon Position	Renk Colour
D*		Düz / Flush		
DM*		Mantar / Mushroom		
DR*		Etanj / Etange		
DR-0		Etanj Oklu / Etange		
DS2		Seçici / Selector		
DC		Mandallı / Handle Switch		
DA2	0-1	Kalıcı / Stay Put	2 Pozisyonlu / 2 Position	
DE		Çevirmeli / Turn to Release	Ø 40mm	

KB Serisi Ø 22 mm Kumanda Buton Tipleri Series Ø 22 mm Control Units Types

BOYUTLAR (mm) / DIMENSIONS (mm)

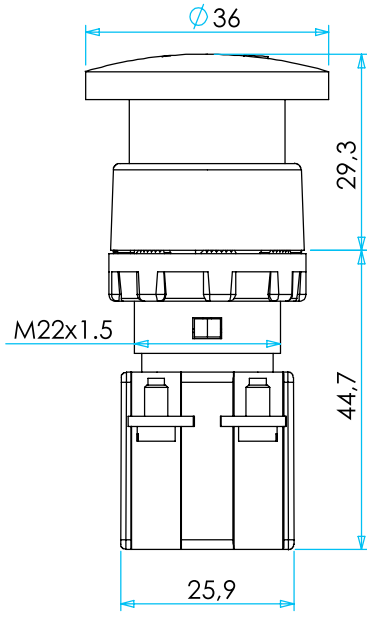

KB14E

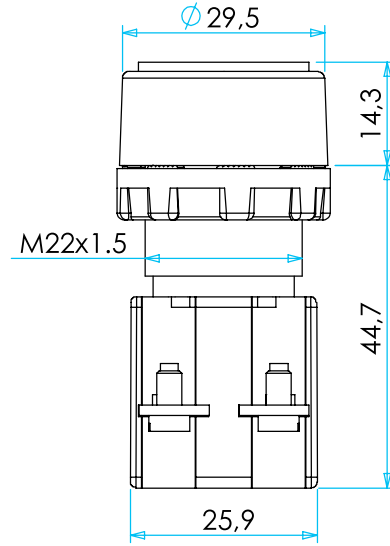

KB14DY

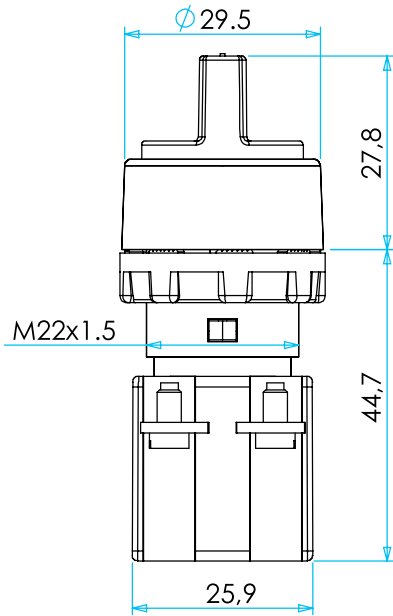

KB14S2

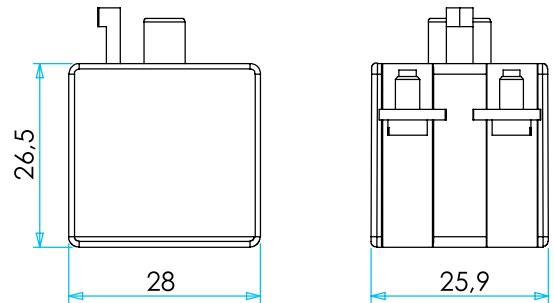

KB14B



Sinyal Lambaları

- Ø10, 14, 22 mm çaplı yuvarlak sinyaller
- Darbe dayanıklı polikarbonat lens
- Farklı terminal çeşitleri ile bağlantı kolaylığı
- Değişik voltaj seçenekleri
- Somunlu veya tırnaklı sistem ile basit ve hızlı montaj

Teknik Bilgiler

Elektriksel Ömür : min. 10.000 saat
Çalışma Sıcaklığı : -5°C/ +85°C



Pilot Lights

- Ø10, 14, 22 mm round types
- Impact - resistant polycarbonate lens
- Connection facility with different terminal types
- Different voltage variety
- Basic and fast mounting with nut and fingerproof system

Technical Information

Electrical Life : min. 10.000 hours
Operating Temperature : -5°C/ +85°C



Kumanda Butonları ve Sinyal Lambaları

Control Units and Pilot Lights



Sinyal Lambaları

Pilot Lights



S100K



S100LK

Ürün Kodu	Cam Tipi	Bağlantı Tipi	Montaj Tipi	Çalışma Gerilimi (V)	Ampul ve Duy Tipi
Code	Lens Type	Connection Type	Mounting Type	Voltage	Lamp and Socket Type
S100*	Yuvarlak, İnce, Termo Round, Thin, Thermo	Kablolu With Cable	Somunlu With Nut	230V AC	Neon Neon
S100L*	Yuvarlak, İnce, Termo Round, Thin, Thermo	Kablolu With Cable	Somunlu With Nut	230V AC	LED LED
S100L1*	Yuvarlak, İnce, Termo Round, Thin, Thermo	Kablolu With Cable	Somunlu With Nut	12V AC/DC	LED LED
S100L2*	Yuvarlak, İnce, Termo Round, Thin, Thermo	Kablolu With Cable	Somunlu With Nut	24V AC/DC	LED LED

* Renk/Colour B: Beyaz/White, K: Kırmızı/Red, M: Mavi/Blue, S: Sarı/Yellow, Y: Yeşil/Green



S102S

Ürün Kodu	Cam Tipi	Bağlantı Tipi	Montaj Tipi	Çalışma Gerilimi (V)	Ampul ve Duy Tipi
Code	Lens Type	Connection Type	Mounting Type	Voltage	Lamp and Socket Type
S102*	Yuvarlak, İnce, Termo Round, Thin, Thermo	Terminalli With Terminal	Somunlu With Nut	230V AC	Neon Neon
S102L*	Yuvarlak, İnce, Termo Round, Thin, Thermo	Terminalli With Terminal	Somunlu With Nut	230V AC/DC	LED LED
S102L1*	Yuvarlak, İnce, Termo Round, Thin, Thermo	Terminalli With Terminal	Somunlu With Nut	12V AC/DC	LED LED
S102L2*	Yuvarlak, İnce, Termo Round, Thin, Thermo	Terminalli With Terminal	Somunlu With Nut	24V AC/DC	LED LED

* Renk/Colour B: Beyaz/White, K: Kırmızı/Red, M: Mavi/Blue, S: Sarı/Yellow, Y: Yeşil/Green



S105Y

Ürün Kodu	Cam Tipi	Bağlantı Tipi	Montaj Tipi	Çalışma Gerilimi (V)	Ampul ve Duy Tipi
Code	Lens Type	Connection Type	Mounting Type	Voltage	Lamp and Socket Type
S105*	Yuvarlak, İnce, Termo Round, Thin, Thermo	Terminalli With Terminal	Somunsuz Nutless	230V AC	Neon Neon

* Renk/Colour B: Beyaz/White, K: Kırmızı/Red, M: Mavi/Blue, S: Sarı/Yellow, Y: Yeşil/Green



S140K

Ürün Kodu	Cam Tipi	Bağlantı Tipi	Montaj Tipi	Çalışma Gerilimi (V)	Ampul ve Duy Tipi
Code	Lens Type	Connection Type	Mounting Type	Voltage	Lamp and Socket Type
S140*	Yuvarlak, İnce, Termo Round, Thin, Thermo	Terminalli With Terminal	Somunsuz Nutless	230V AC	Neon Neon

* Renk/Colour B: Beyaz/White, K: Kırmızı/Red, M: Mavi/Blue, S: Sarı/Yellow, Y: Yeşil/Green

Kumanda Butonları ve Sinyal Lambaları

Control Units and Pilot Lights



Sinyal Lambaları

Pilot Lights



S140Y2

Ürün Kodu	Cam Tipi	Bağlantı Tipi	Montaj Tipi	Çalışma Gerilimi (V)	Ampul ve Duy Tipi
Code	Lens Type	Connection Type	Mounting Type	Voltage	Lamp and Socket Type
S140*1	Yuvarlak, İnce, Termo Round, Thin, Thermo	Terminalli With Terminal	Somunlu With Nut	12V AC / DC	Flamanlı With Filament
S140*2	Yuvarlak, İnce, Termo Round, Thin, Thermo	Terminalli With Terminal	Somunlu With Nut	24V AC / DC	Flamanlı With Filament

* Renk/Colour B: Beyaz/White, K: Kırmızı/Red, M: Mavi/Blue, S: Sarı/Yellow, Y: Yeşil/Green



S145S

Ürün Kodu	Cam Tipi	Bağlantı Tipi	Montaj Tipi	Çalışma Gerilimi (V)	Ampul ve Duy Tipi
Code	Lens Type	Connection Type	Mounting Type	Voltage	Lamp and Socket Type
S145*	Yuvarlak, İnce, Termo Round, Thin, Thermo	Terminalli With Terminal	Somunsuz Nutless	230V AC	Neon Neon
S145*1	Yuvarlak, İnce, Termo Round, Thin, Thermo	Terminalli With Terminal	Somunsuz Nutless	12V AC / DC	Flamanlı With Filament
S145*2	Yuvarlak, İnce, Termo Round, Thin, Thermo	Terminalli With Terminal	Somunsuz Nutless	24V AC / DC	Flamanlı With Filament

* Renk/Colour B: Beyaz/White, K: Kırmızı/Red, M: Mavi/Blue, S: Sarı/Yellow, Y: Yeşil/Green



S220K

Ürün Kodu	Cam Tipi	Bağlantı Tipi	Montaj Tipi	Çalışma Gerilimi (V)	Ampul ve Duy Tipi
Code	Lens Type	Connection Type	Mounting Type	Voltage	Lamp and Socket Type
S220*	Yuvarlak, Konik, Normal Round, Conic, Normal	Vidalı Screw Mounting	Somunlu With Nut	230V AC	Neon - Plastik Neon - Plastic
S220*6	Yuvarlak, Konik, Normal Round, Conic, Normal	Vidalı Screw Mounting	Somunlu With Nut	-	Neon - Vidalı Neon - Screwed

* Renk/Colour B: Beyaz/White, K: Kırmızı/Red, M: Mavi/Blue, S: Sarı/Yellow, Y: Yeşil/Green

Kumanda Butonları ve Sinyal Lambaları

Control Units and Pilot Lights



S222K



S222LS



S224Y

Ürün Kodu	Cam Tipi	Bağlantı Tipi	Montaj Tipi	Çalışma Gerilimi (V)	Ampul ve Duy Tipi
Code	Lens Type	Connection Type	Mounting Type	Voltage	Lamp and Socket Type
S222*	Düz, Petek, Termo Flat, Cellular, Thermo	Vidalı Screw Mounting	Somunlu With Nut	230V AC	Neon - Plastik Neon - Plastic
S222L*	Düz, Petek, Termo Flat, Cellular, Thermo	Vidalı Screw Mounting	Somunlu With Nut	230V AC	LED LED

* Renk/Colour B: Beyaz/White, K: Kırmızı/Red, M: Mavi/Blue, S: Sarı/Yellow, Y: Yeşil/Green

Ürün Kodu	Cam Tipi	Bağlantı Tipi	Montaj Tipi	Çalışma Gerilimi (V)	Ampul ve Duy Tipi
Code	Lens Type	Connection Type	Mounting Type	Voltage	Lamp and Socket Type
S224*	Düz, Petek, Termo Flat, Cellular, Thermo	Terminalli / Vidalı With Terminal / Screw Mounting	Somunlu With Nut	230V AC	Neon - Sürgülü Neon - Bayonet Ba9s
S224*7	Düz, Petek, Termo Flat, Cellular, Thermo	Terminalli / Vidalı With Terminal / Screw Mounting	Somunlu With Nut	-	Sürgülü Ba9s - 10 mm Bayonet Ba9s - 10 mm

* Renk/Colour B: Beyaz/White, K: Kırmızı/Red, M: Mavi/Blue, S: Sarı/Yellow, Y: Yeşil/Green

Ampuller / Neon Lamps



PDA



N201



NA101



LED220K



LED24S

Ürün Kodu	Çalışma Gerilimi (V)	Akım (mA)	Ampul ve Duy Tipi	Ömür (s)	Renk
Code	Voltage	Current	Lamp and Socket Type	Life (h)	Colour
PDA	230 V AC	1.10÷1.80	Neon-Plastik Neon-Plastic	10.000	Sarı Yellow
NA101	230 V AC	0.80÷1.70	Neon-Vidalı 10 mm EX-10 Neon-Screw 10 mm EX-10	10.000	Sarı Yellow
NA101Y	230 V AC	0.45÷1.00	Neon-Vidalı 10 mm EX-10 Neon-Screw 10 mm EX-10	10.000	Yeşil Green
NA201	230 V AC	2.30÷2.50	Neon-Sürgülü 10 mm Ba9s Neon-Bayonet 10 mm Ba9s	10.000	Sarı Yellow
NA201Y	230 V AC	1.60÷1.80	Neon-Sürgülü 10 mm Ba9s Neon-Bayonet 10 mm Ba9s	10.000	Yeşil Green
LED24*	24 VDC/ AC		Ba9S Duyulu LED		* *
LED220*	220 V AC		Ba9S Duyulu LED		* *

* Beyaz, Kırmızı, Mavi, Sarı, Yeşil / White, Red, Blue, Yellow, Green

Kumanda Butonları ve Sinyal Lambaları

Control Units and Pilot Lights



BOYUTLAR (mm) / DIMENSIONS (mm)

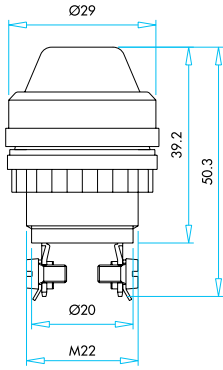

S220

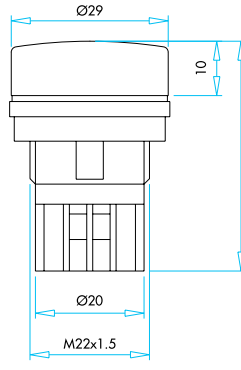

S222

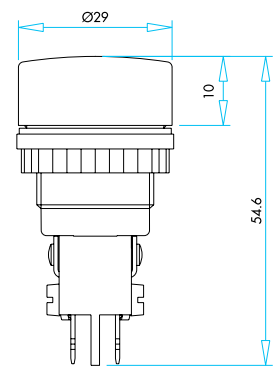

S224

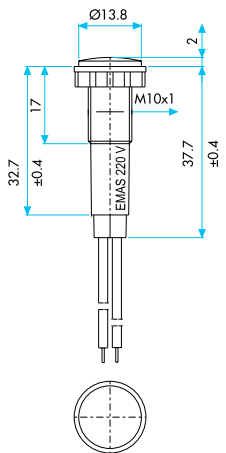

S100

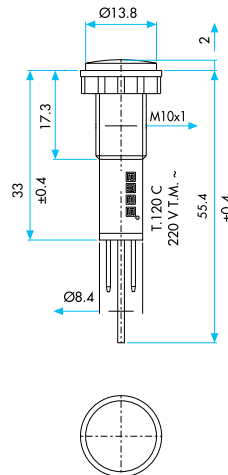

S102

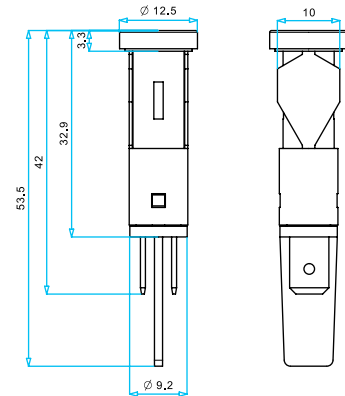

S105

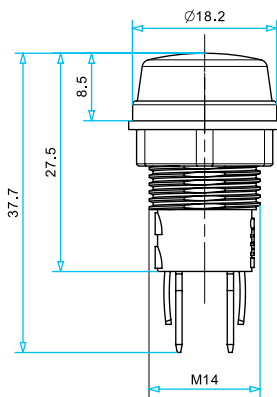

S140

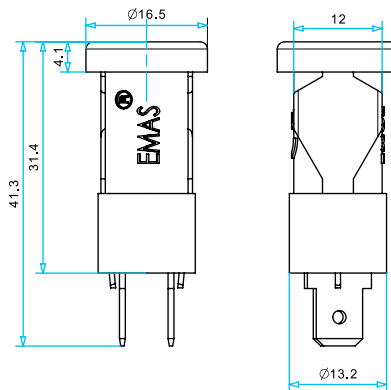

S145

X-ON Electronics

Largest Supplier of Electrical and Electronic Components

Click to view similar products for [LED Lighting Mounting Accessories](#) category:

Click to view products by [EMAS](#) manufacturer:

Other Similar products are found below :

[3635](#) [PALBF18](#) [C16142_HEKLA-SOCKET-K](#) [3SU1900-0BC31-0AA0](#) [3SU1900-0BC31-0NB0](#) [2213118-2](#) [47.319.6380.50](#) [3SU1401-2BB40-1AA0](#) [3SU1401-2BB60-1AA0](#) [1SFA611621R1041](#) [23110040](#) [23120022](#) [23130000](#) [68550022](#) [68550040](#) [70290000](#) [70290022](#) [70290040](#) [70300022](#) [70300040](#) [76620000](#) [76990022](#) [77280022](#) [77980022](#) [77990001](#) [77990002](#) [77990040](#) [83130001](#) [83130040](#) [83150001](#) [83150022](#) [83150040](#) [83980001](#) [83980040](#) [83990001](#) [83990022](#) [83990040](#) [84040022](#) [84510002](#) [86050038](#) [86180003](#) [89080002](#) [89080022](#) [89140002](#) [89980002](#) [89980019](#) [98050040](#) [A1070001](#) [A1070002](#) [A2070001](#)