

CR65 series, with a blue case, outside the US and the UK.

PT65 series

Rotary code switches

Through-hole

UG1006-A



- 4 actuator types
- Save board space
- Highly reliable
- Solder and flux sealed, washable

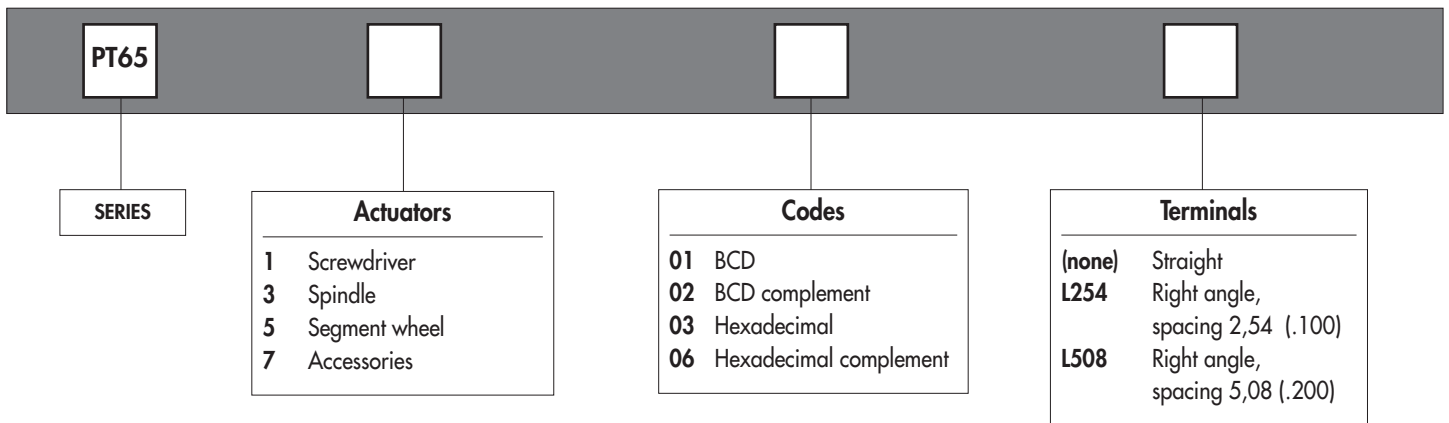

ELECTRICAL SPECIFICATIONS
<ul style="list-style-type: none"> • Operating voltage : 24 VDC max. • Contact load, static : 400mA max. • Contact load, dynamic : 150mA max. • Initial contact resistance : 80 mΩ max. • Insulation resistance : 100 MΩ min.

MECHANICAL AND THERMAL SPECS
<ul style="list-style-type: none"> • Torque : 0,7 Ncm min. • Expected life : 10.000 cycles min. • Operating temperature : -20°C to +70°C

MATERIALS
<ul style="list-style-type: none"> • Base : UL94-V0, high temperature thermoplastic • Cover : UL94-V0, high temperature thermoplastic, grey • Actuator : PA 4.6 nylon • Contacts : gold over nickel plated phosphor bronze • Terminals : tin plated

SOLDER RECOMMENDATIONS
(DIN CEI 68-2-20)
<ul style="list-style-type: none"> • Manual soldering : 340°C max. for 2 seconds max. • Wave soldering : 260°C max. for 10 seconds max.

PACKAGING
<ul style="list-style-type: none"> • Switches for screwdriver slot or accessory actuation (PT651 and PT657) : tubes of 50 pieces • Switches with spindle (PT653) or segment wheel (PT655) : candy trays of 50 pieces • Accessories : bags of 50 pieces

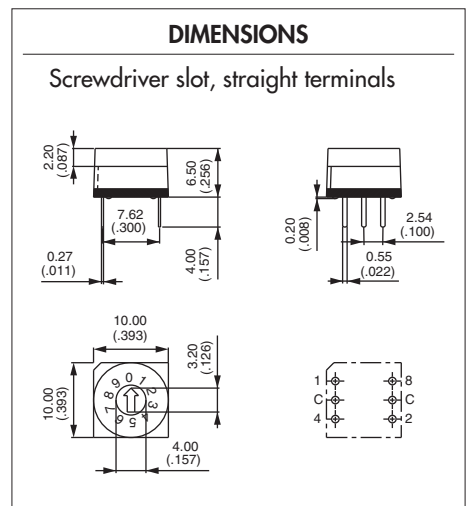

Dimensions : first dimensions are in mm while inches are shown as bracketted numbers.

PT65 series

Rotary code switches

Through-hole

ACTUATORS

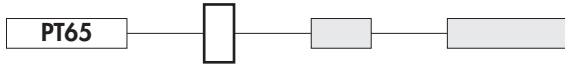

1 Screwdriver

3 Spindle (grey)

5 Segment wheel (grey)

7 Accessories

See next page

CODES / TRUTH TABLES

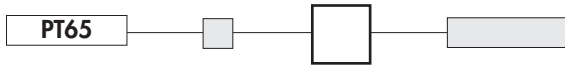

01 BCD

	C	1	2	4	8	
0	●					0
1	●	●				1
2	●		●			2
3	●	●	●			3
4	●			●		4
5	●	●		●		5
6	●		●	●		6
7	●	●	●	●		7
8	●				●	8
9	●	●			●	9

02 BCD complement

	C	1	2	4	8	
0	●	●	●	●	●	0
1	●	●	●	●	●	1
2	●	●	●	●	●	2
3	●	●	●	●	●	3
4	●	●	●	●	●	4
5	●	●	●	●	●	5
6	●	●	●	●	●	6
7	●	●	●	●	●	7
8	●	●	●	●	●	8
9	●	●	●	●	●	9

03 Hexadecimal

	C	1	2	4	8	
0	●					0
1	●	●				1
2	●		●			2
3	●	●	●			3
4	●			●		4
5	●	●		●		5
6	●		●	●		6
7	●	●	●	●		7
8	●				●	8
9	●	●			●	9
10	●		●		●	A
11	●	●			●	B
12	●		●		●	C
13	●	●		●	●	D
14	●		●	●	●	E
15	●	●	●	●	●	F

06 Hexadecimal complement

	C	1	2	4	8	
0	●	●	●	●	●	0
1	●	●	●	●	●	1
2	●	●	●	●	●	2
3	●	●	●	●	●	3
4	●	●	●	●	●	4
5	●	●	●	●	●	5
6	●	●	●	●	●	6
7	●	●	●	●	●	7
8	●	●	●	●	●	8
9	●	●	●	●	●	9
10	●	●	●	●	●	A
11	●	●	●	●	●	B
12	●	●	●	●	●	C
13	●	●	●	●	●	D
14	●	●	●	●	●	E
15	●	●	●	●	●	F

▲ Position ▲ Marking

TERMINALS



(none) Straight

L254 Right angle spacing 2,54 (.100)

L508 Right angle spacing 5,08 (.200)

PT65 series

Rotary code switches

Through-hole

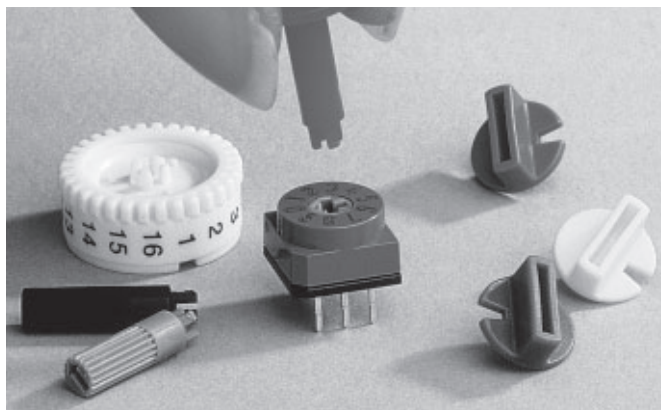

ACCESSORIES ADAPTED TO YOUR APPLICATIONS

Basic model PT657 has been designed to accept different actuators with snap-in connection.

According to your application, you can choose between spindles or plastic knobs in two different lengths and a Ø 17 mm (.669) knurled wheel for lateral marking.

Standard colours are shown below. Special colours are also available on request.

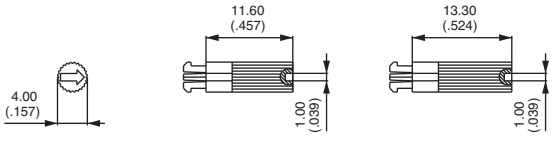
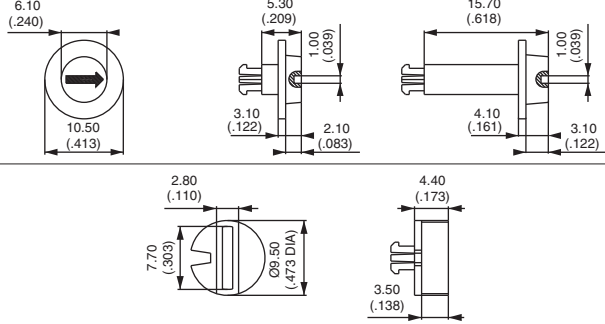
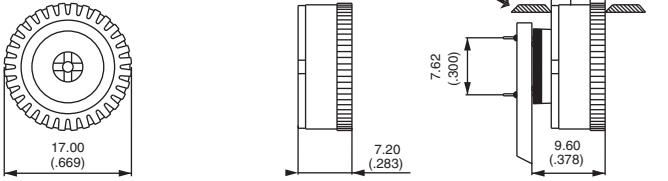
<p>SPINDLES Length 11,6 mm (standard) Length 13,3 mm</p>	<p>P/N U4822 U4824 U4832</p>	<p>COLOURS black grey black</p>	
<p>PLASTIC KNOBS Length 5,3 mm (standard) Length 15,7 mm Length 4,4 mm</p>	<p>P/N U4906 U4916 U4941 U4943 U4944 U4945 U4946</p>	<p>COLOURS red red blue green grey yellow red</p>	
<p>KNURLED WHEEL (unmarked - marking on request)</p>	<p>P/N U4847/1</p>	<p>COLOUR white/black</p>	<p>→ Panel</p> 

STANDARD PRODUCTS

MODELS CODES	FOR SCREWDRIVER		WITH SPINDLE	WITH SEGMENT WHEEL		FOR ACCESS.
	Upper actuation	Side actuation	Upper actuation	Upper actuation	Side actuation	Upper actuation
BCD	PT65101	PT65101L254	PT65301	PT65501	-	PT65701
		PT65101L508			-	
BCD complement	PT65102	-	-	PT65502	-	-
Hexadecimal	PT65103	PT65103L254	PT65303	PT65503	PT65303L254	-
		PT65103L508				-
Hexadecimal complem.	PT65106	-	-	-	-	-

X-ON Electronics

Largest Supplier of Electrical and Electronic Components

Click to view similar products for [Hartmann](#) manufacturer:

Other Similar products are found below :

[B5LS](#) [P65SMT701](#) [PT65103](#) [PT65712L254](#) [P36THR101L508](#) [SRPT659544GELB](#) [PT65501L254](#) [P65THR101L254](#) [PT65721](#)
[SMCD137AK2](#) [P25SMT303](#) [P65THR103L254](#) [PT65 701 L 5,08](#) [P25SMT101](#) [SX254](#) [DPS9/10P2](#) [PT65503](#) [P36THR101L254](#)
[PT65501SCHALTRADGRAU](#) [PT65103L508](#) [P36SMT103TR](#) [PT65106](#) [PT65703L508](#) [PT65703](#) [P36SMT101](#) [P36THR103L254](#) [PT65701](#)
[PT65103L254](#) [PT65303](#) [P65SMT103TR](#)