

E31 eSM—Multiplexed Keypad



E30 eSM—Multiplexed Rockers



E32 eSM—Multiplexed Rockers



E33 eSM—Sealed Multiplex Rocker Switch Units



eVu—Electronic Vehicle Display



1.1 E31 eSM—Keypad Multiplexed Switch Module	
Product Description	V11-T1-2
Application Description	V11-T1-2
Features and Benefits	V11-T1-2
Catalog Number Selection	V11-T1-3
Product Selection	V11-T1-4
Technical Data and Specifications	V11-T1-5
Dimensions	V11-T1-5
1.2 E30 eSM—Multiplexed Rocker Switch Units	
Product Description	V11-T1-7
Application Description	V11-T1-7
Product Selection	V11-T1-7
Technical Data and Specifications	V11-T1-8
Wiring	V11-T1-9
Dimensions	V11-T1-9
1.3 E32 eSM—Multiplexed Rocker Switch Units	
Product Description	V11-T1-10
Application Description	V11-T1-10
Features and Benefits	V11-T1-10
Product Selection	V11-T1-11
Accessories	V11-T1-11
Wiring	V11-T1-12
Dimensions	V11-T1-13
1.4 E33 eSM—Sealed Multiplexed Rocker Switch Units	
Product Description	V11-T1-14
Application Description	V11-T1-14
Features and Benefits	V11-T1-14
Product Selection	V11-T1-15
Wiring	V11-T1-15
Technical Data and Specifications	V11-T1-15
Dimensions	V11-T1-16
1.5 eVu—Electronic Vehicle Display	
Product Description	V11-T1-17
Application Description	V11-T1-17
Features	V11-T1-17
Product Selection	V11-T1-17
Dimensions	V11-T1-17

E31 eSM—Keypad Multiplexed Switch Module



Product Description

Because your vehicle is continuously exposed to nature's elements, we offer the latest in Eaton's multiplexed line of switch product, the E31 Keypad eSM. Eaton's E31 Keypad eSM multiplex switch module offers a flexible and sealed solution for high-density switch requirements in severe environments. The keypad can be configured with any graphic/switch, as well as with customer-defined illumination. For customers requiring additional switches, expansion modules can be used with no requirement for additional CAN nodes. For additional product flexibility and differentiated operator control, the E31 Keypad eSM is designed to communicate with Eaton's E32 and E33 sealed rocker expansion modules.

Application Description

Great for specialty vehicle, construction, and agricultural equipment markets. The eSM product is especially suitable for severe environmental applications and where there is a desire to move to a multiplexed solution to simplify wiring and control requirements. Typical applications are:

Target Market Segments:

- Tractors
- Wheel loaders
- Refuse vehicles
- Concrete mixers
- Street sweepers
- Mining equipment
- Emergency vehicles
- Transit buses

Contents

Description

E31 eSM—Keypad Multiplexed Switch Module

	<i>Page</i>
Catalog Number Selection	V11-T1-3
Product Selection	V11-T1-4
Technical Data and Specifications	V11-T1-5
Dimensions	V11-T1-5

Features and Benefits

Key Features

- Fully compliant with J1939/CAN 2.0b messaging
- IP68 degree of protection from front and rear of module
- Rocker and keypad expansion module capability
- Exceptional illumination characteristics
 - LED backlighting of icons
 - Four color daylight-visible indicators per switch
 - Message-controlled dimming and flash rates
- Large switch surface area and alignment ridges for ease of gloved hand use
- Exceptional tactile and audible feedback of switch actuation
- Electrical/mechanical life to over 1,000,000 cycles
- 9–32 Vdc operating voltage
- Immunity per SAE J1455/1113
 - Power disturbance
 - Radiated immunity
 - Radiated emissions

Advantages

- Reduced assembly labor due to ease of installation, allowing for mounting and connection of eight switches at one time as opposed to individually
- Reduced wire harness complexity; uses one harness to a controller, reducing wiring, connection point, and controller requirements
- Reduced harness size offers an overall reduction in weight, improving operational efficiency of the equipment
- Increase in life-cycle over traditional electromechanical switches
- Front, rear, and panel sealing for harsh environments

Catalog Number Selection

How To Order—E31 eSM—Keypad Multiplexed Switch Module, 2x4

To determine complete catalog number, start with the appropriate control type and add the appropriate code letters and/or numbers.

Example: **E31 2 4 M 4 W 1 CV 1**

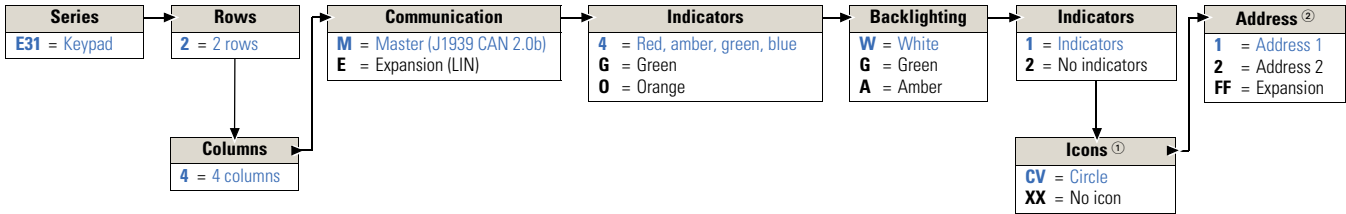

How To Order—E31 eSM—Keypad Master Module, 4x3

To determine complete catalog number, start with the appropriate control type and add the appropriate code letters and/or numbers.

Example: **E31 4 3 M 4 W CV 1**

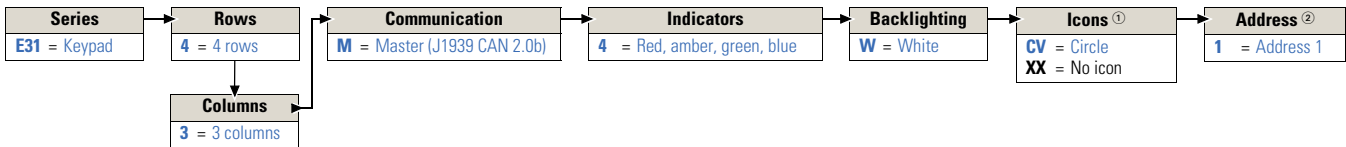

How To Order—E31 eSM—Keypad Master Module, 3x5

To determine complete catalog number, start with the appropriate control type and add the appropriate code letters and/or numbers.

Example: **E31 3 5 M 4 W CV 1**

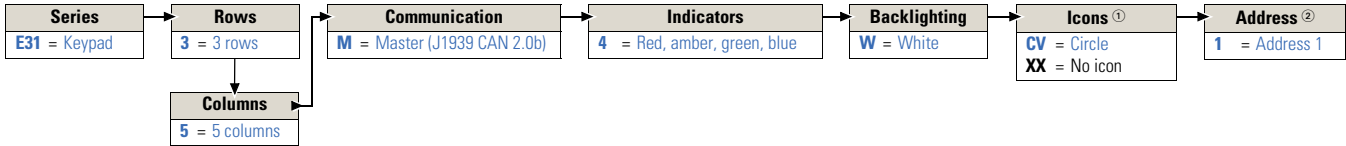

Notes

- ① Contact Eaton sales for custom graphics. See V11-T2-80–V11-T2-84 and V11-T2-95–V11-T2-102, symbols library, for available graphics.
- ② For use of multiple masters on one system. (Address 3–8 available as special order.)

Product Selection

Master

E3124M4W1CV1



E31 Keypad eSM Master Module, 2x4

Basic Part	Indicator Colors	Backlighting	Icon Graphic	Address	Catalog Number
E3124M	Red, amber, green, blue	White	Circle	1	E3124M4W1CV1
				2	E3124M4W1CV2
			None	1	E3124M4W1XX1
				2	E3124M4W1XX2
	Green	Green	Circle	1	E3124MGG1CV1
				2	E3124MGG1CV2
			None	1	E3124MGG1XX1
				2	E3124MGG1XX2
Orange	Amber	Circle	1	E3124MOA1CV1	
			2	E3124MOA1CV2	
		None	1	E3124MOA1XX1	
			2	E3124MOA1XX2	

E3143M—Custom



E31 Keypad eSM Master Module, 4x3

Basic Part	Indicator Colors	Backlighting	Icon Graphic	Address	Catalog Number
E3143M	Red, amber, green, blue	White	Circle	1	E3143M4W1CV1
				2	E3143M4W1CV2
			None	1	E3143M4W1XX1
				2	E3143M4W1XX2

E3135M—Custom



E31 Keypad eSM Master Module, 3x5

Basic Part	Indicator Colors	Backlighting	Icon Graphic	Address	Catalog Number
E3135M	Red, amber, green, blue	White	Circle	1	E3135M4W1CV1
				2	E3135M4W1CV2
			None	1	E3135M4W1XX1
				2	E3135M4W1XX2

Expansion

E3124EGG1XXFF



E31 Keypad eSM Expansion Module, 2x4 ^①

Basic Part	Indicator Colors	Backlighting	Icon Graphic	Address	Catalog Number
E3124E	Red, amber, green, blue	White	Circle	FF	E3124E4W1CVFF
				FF	E3124E4W1XXFF
			None	FF	E3124EGG1CVFF
				FF	E3124EGG1XXFF
	Green	Green	Circle	FF	E3124EGG1CVFF
				FF	E3124EGG1XXFF
			None	FF	E3124E0A1CVFF
				FF	E3124E0A1XXFF

Note

^① Expansion keypad module is available in 2x4 configuration only.

Technical Data and Specifications

Master Module Wiring Harness

The interconnection between the master module and the controller uses a minimum four-wire harness with an additional two pins associated to expansion module interconnection. Wire sizes of 16–20 AWG can be accommodated with the Deutsch connector shown in the mating connector information.

Wiring Harness

PIN	Master	Expansion
1	Vbat	Vbat
2	Common	Common
3	CAN (+)	LIN
4	CAN (-)	LIN
5	Common	Common
6	LIN	Vbat

Environmental and Electronic Specifications

- Operational temperature: -40° to +85°C
- Storage temperature: -40° to +95°C
- Operational voltage: 9–32 Vdc
- Degree of protection: IP68
- Mechanical shock: 30g for 11 msec
- Handling drop: 1m
- Electrical/mechanical life: 1M cycles
- Load dump
 - SAE J1455: 100V/12V systems
 - SAE J1113/11: 174V for 24V systems

Mating Connector Information

Deutsch DT Series connector
 6-pin connector: DT06-6S
 • EP11 (Black–Master)
 • E008 (Gray–Expansion)
 6-pin wedge lock: W6S
 Female terminal: 0462-201-16141 (16-18-20 AWG)
 Hole plug: 0413-217-1605
 Crimper: HDT-48-00



E32 and E33 Rocker Expansion Modules

The Keypad eSM master module is capable of supporting Eaton’s E32 and E33 product line of rocker eSMs. The E32 and E33 product line is an above-panel-style rocker switch module that contains any combination of rocker or indicator functionality with no additional CAN node requirement to the system. Similar to the keypad, the rocker module offers icon graphic illumination with up to four center indicator bar LEDs for status or mode. This product is also fully functional to support dimming and flashing capabilities through software command.

Dimensions

Approximate Dimensions in mm [in]

2x4 Mounting Dimensions

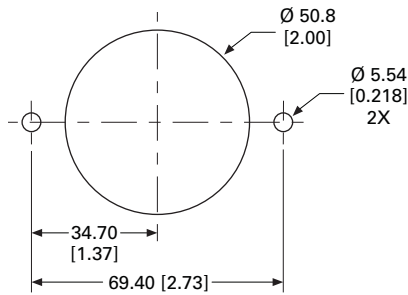

E31 Keypad Master or Expansion Module

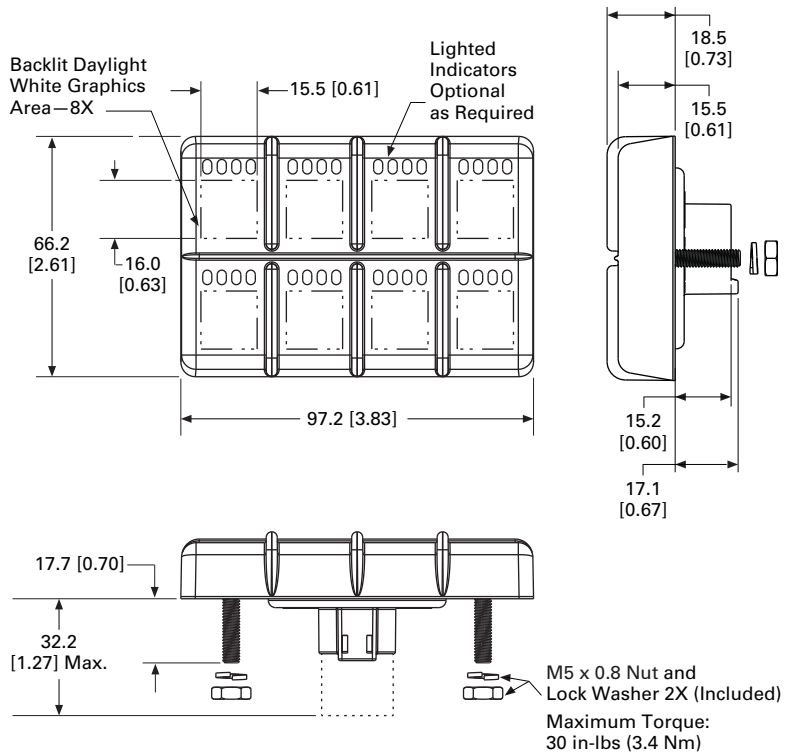

1.1

Electronic Products

E31 eSM—Keypad Multiplexed Switch Module

1

Approximate Dimensions in mm [in]

4x3 Mounting Dimensions

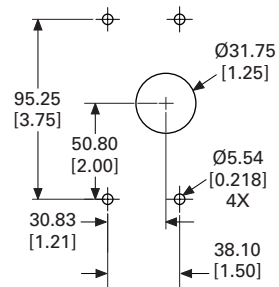

Recommended Panel Opening

E31 Keypad Master Module

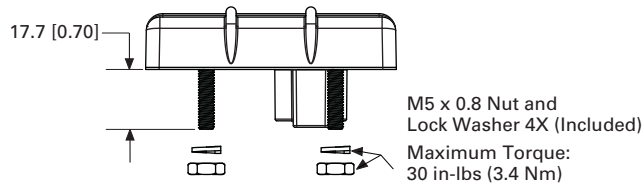
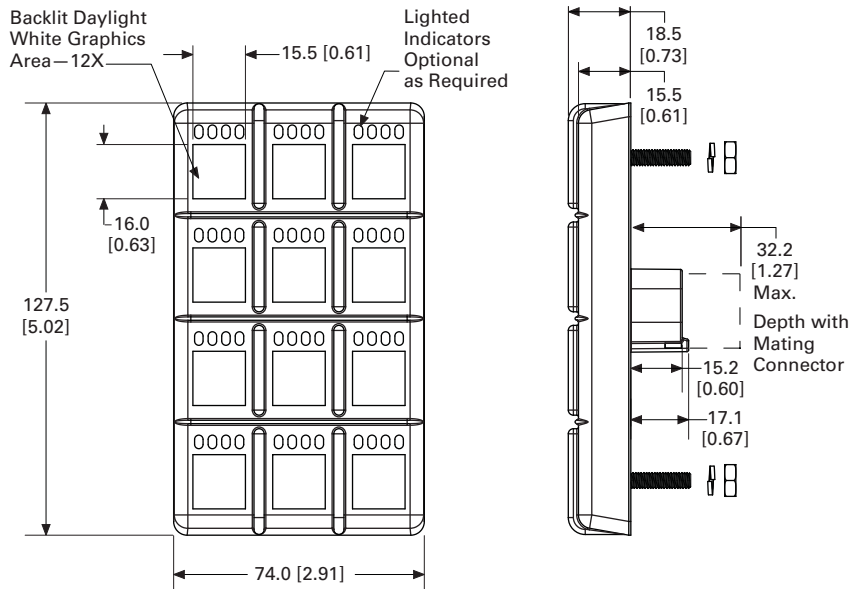

3x5 Mounting Dimensions

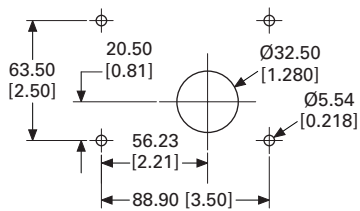

Recommended Panel Opening

E31 Keypad Master Module

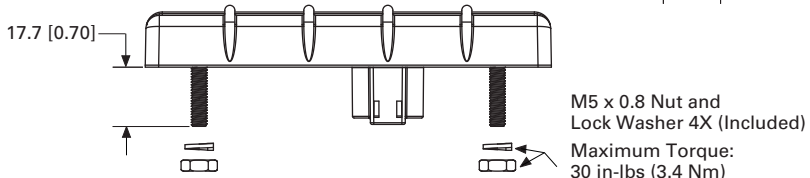
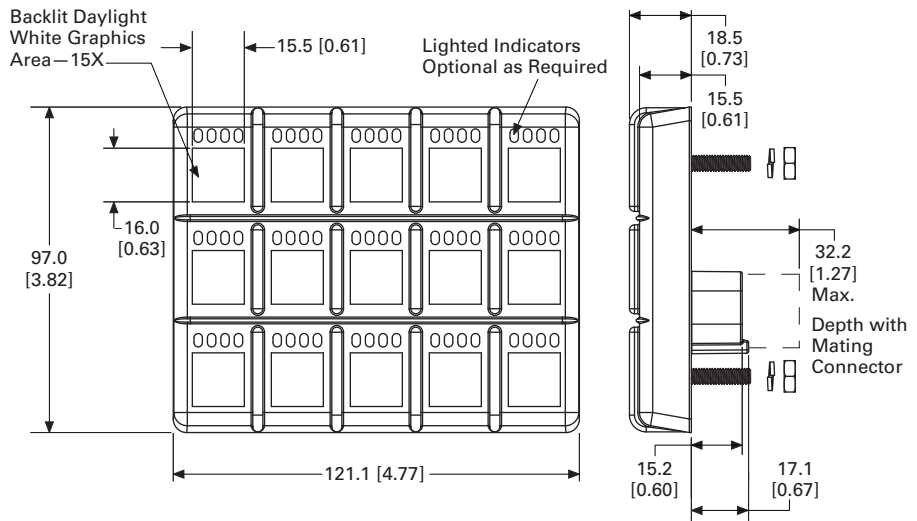

E30 eSM—Multiplexed Rocker Switch Units



Contents

Description

E30 eSM—Multiplexed Rocker Switch Units	
Technical Data and Specifications	V11-T1-8
Wiring	V11-T1-9
Dimensions	V11-T1-10

Product Description

Tailored to meet the same look and feel of Eaton’s NGR product line, the E30 eSM offers the added benefits of multiplexed control and system simplification. The E30 eSM is a below-panel styled multiplexed rocker module capable of communicating via SAE J1939 CAN 2.0b. The modules are set up in a master-expansion configuration capable of supporting up to seven

expansion modules per master thus minimizing the impact on a controller to a single CAN node. Additionally, up to eight master modules per system can be accommodated. Communication with the expansion modules is done via a four-wire sub-bus.

Multiplexing of switches can significantly reduce harness costs and complexity as well as improve installation cycle time.

Application Description

The E30 eSM is especially suited for applications that require both high current independently wired switches using Eaton NGR switches as well as those applications realizing the benefits of multiplexing. The E30 eSM is styled to match the Eaton NGR switch for a consistent look and feel to your dash panel.

The E30 eSM also has the capability of having a separate input for key switch and dimmer control functions to increase the flexibility of the product to interface seamlessly to your vehicle.

Customization of the E30 eSM is done by creating an application specific rocker with icons representing the function as well as by use of colored LEDs to highlight status. Two and three position as well as momentary or maintained circuits are identified using a sub-actuator to offer complete flexibility.

Target Market Segments:

- Motor coach/bus
- Specialty vehicle
- Truck

Master Expansion Modules

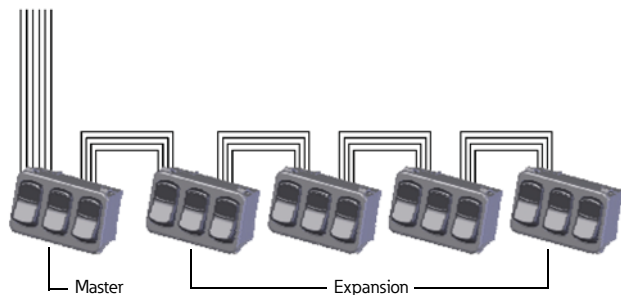

Product Selection

Note: All products are custom ordered. Contact your local Eaton Sales Representative.

Technical Data and Specifications

E30 eSM Specifications

Description	Specification
Power supply	12 Vdc regulated power, 1.5A
Operating temperature	-40° to 85°C
Storage temperature	-40° to 85°C
Sealing	IP42
Illumination	Dependent on search lighting, customer defined LED color
Switch life cycle	
Electrical life	250,000 cycles
Mechanical life	250,000 cycles
Radiated immunity	SAE J1113/21, 100 v/m
Radiated emissions	SAE J1113/41, Class 2
Dimming	0-10 Vdc Analog Input (0 = 0% and 10V = 100% brightness)
Connectors	Delphi Micro VHT 15499927 Delphi Micro VHT 13513469

Power Supply

A regulated 12 Vdc power supply capable of providing 1.5A should be connected to terminals 1, 5 and 6 of the six-pole connector of the master module only. All connected expansion modules receive their supply power from the master module.

Diagnostics

The LED indicators at the back of the modules show the status of the internal diagnostics as follows:

Diagnostics

Label	Color	Meaning
J1939 ACTIVE	Red	CANbus active
MODULE ACTIVE	Amber	Sub bus active
SWITCH CHANGE	Green	Switch change

Communication

The communication to and from the master module is fully compliant to the SAE J1939/CAN 2.0b protocol.

The application-specific J1939 message parameters are as follows:

Transmission Repetition

Description	Specification
Transmission repetition rate	100 ms
Data length	8 bytes
Data page	0
PDU format	255
PDU specific	160
Default priority	5
Parameter group number	65440

SAE J1455

Description	Specification
Dust test (Non-operational)	SAE J726 Course
Mechanical vibration	2gs from 10 to 2 kHz
Mechanical shock	30g
Handling drop	1m, 3-axis
Load dump transient	Table 4A and 4B
Reverse voltage	-28 Vdc for 5 mins
Over-voltage	48 Vdc for 5 mins
Under-voltage	4 Vdc for 5 mins

Message Contents

Status

Byte	Status
Byte 1	Master module status
Byte 2	Expansion module 1 status
Byte 3	Expansion module 2 status
Byte 4	Expansion module 3 status
Byte 5	Expansion module 4 status
Byte 6	Expansion module 5 status
Byte 7	Expansion module 6 status
Byte 8	Expansion module 7 status

Within each status byte, the bits are assigned to the individual switches as follows:

Bit	Switch
Bit 8&7	Not defined
Bit 5&6	Switch 1 status
Bit 3&4	Switch 2 status
Bit 1&2	Switch 3 status

where the switches are numbered as shown below.

Switches

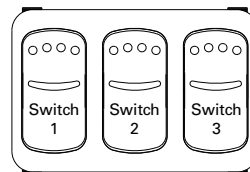

The two status bit pairs represent the switch state in the following manner:

Bit	Switch
00	Switch in DOWN position
01	Switch in MIDDLE position
10	Switch in UP position
11	Not defined

where the position assignment is as shown below.

Position Assignment

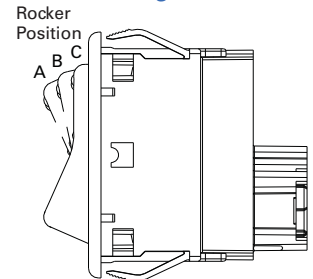

A = DOWN
B = MIDDLE
C = UP

Wiring

The master unit is connected using six unshielded wires. The connection from the master to the first expansion module and between any consecutive expansion modules is made using four unshielded wires.

Master Module

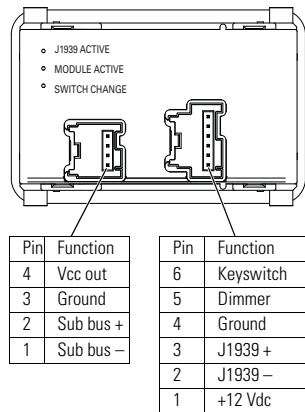

Expansion Module

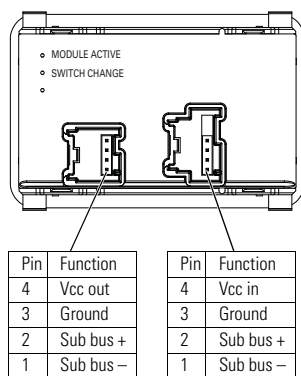

Master wiring:

- Six unshielded wires

Expansion wiring:

- Four unshielded wires

Dimensions

Approximate Dimensions in Inches (mm)

Mounting Dimensions

If you want to mount the modules in a panel, the opening in the panel should be rectangular, 2.835 in wide and 1.732 in high (72.00 mm wide and 44.00 mm high).

The panel thickness should be between 0.039 and 0.157 in (1.00 and 4.00 mm).

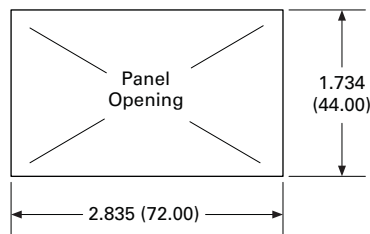

E30 eSM Multiplexed Rocker Switch Units

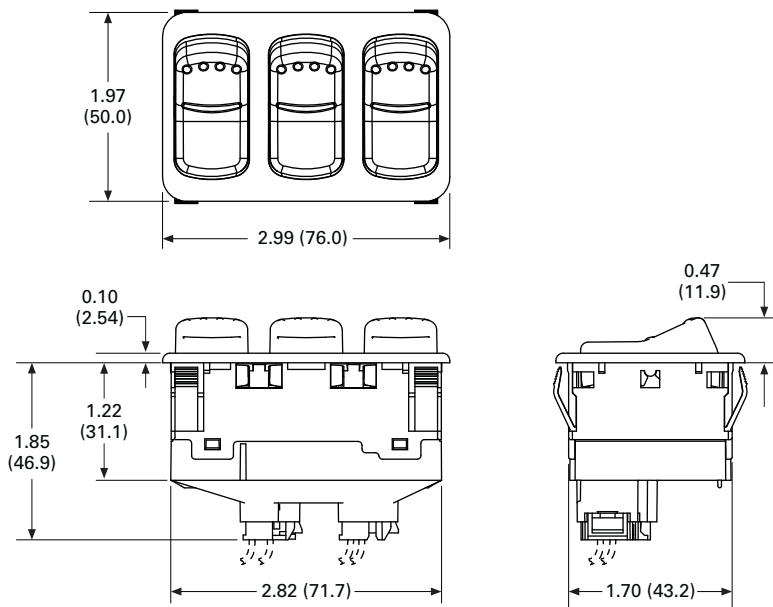



Contents

Description

	<i>Page</i>
E32 eSM—Multiplexed Rocker Switch Units	
Product Selection	V11-T1-13
Accessories	V11-T1-13
Wiring	V11-T1-15
Dimensions	V11-T1-17

Product Description

Multiplexed Master Module using a LIN sub bus to communicate with up to seven expansion modules.

Offering a high level of flexibility, the above-panel electronic multiplex switch module (E32 eSM) covers your wide range of switch and indicator applications using standard or custom graphics, as well as a full range of circuits and illumination options. The above-panel E32 eSM has top, center and bottom LED lighting with software that offers advanced circuit and lighting flexibility, including dimming and flashing options via J1939 CANbus communication. The indicator bar can be lighted with up to four separate colors to indicate operational status, vehicle mode and faults. All standard combinations of maintained and momentary switch actions, matching indicator caps and dummy plugs, along with the complementary styled SVR electromechanical rocker switch are available to complete the offering.

Compared with electromechanical switches, multiplexed switch modules offer several advantages.

- Reduced assembly labor due to ease of installation, allowing for mounting and connection of three switches at one time versus individually
- Reduced wire harness complexity, using one harness to a controller to accommodate up to 24 switches and a three-wire interconnect between expansion and master modules
- Reduced harness size offers an overall reduction in weight, improving operational efficiency of the equipment
- Increase in switch life-cycle over traditional electromechanical switches (500k cycles)

Application Description

Target Market Segments

This product is targeted at the bus/coach, truck and specialty vehicle markets. The product is especially suitable where a customer has “gangs” of switches mounted in a panel or dashboard, and expansion modules can be connected easily to a master module.

- On-road specialty vehicle
- EMS vehicles
- Street sweepers
- Recreational vehicles
- Motor coach/bus
- Refuse vehicles

Features and Benefits

- Fully compliant with J1939 CAN 2.0b messaging
- LED lighting in top, center and bottom positions
- Late point definition of circuit and rockers to reduce inventory and accommodate multiple application requirements
- 9–16 Vdc operating voltage
- 16–32 Vdc operating voltage
- IP53 degree of protection from the front
- Easy address assignment
- Immune to SAE J1455 and J1113 power disturbances
- Front panel removable for ease of maintenance
- Sleep mode available to reduce current draw on the battery
- Wake on switch change configurable
- Decorative-style rocker with matching indicator option available
- Colored rocker options
- CAN controlled digital logic output—500 mA

Product Selection

Note: All fully-assembled products are custom ordered. Contact your local Eaton Sales Representative.



Modules

Voltage	Module	Icon Lighting	Status Bar Lighting	Catalog Number
9–16V	Master	Amber	Amber	E321AAAAAAAAA01
		Green	Green	E321GGGGGGGGG01
		White	Red, Amber, Green, Blue	E321W4WW4WW4W01
	Expansion	Amber	Amber	E322AAAAAAAAA01
		Green	Green	E322GGGGGGGGG01
		White	Red, Amber, Green, Blue	E322W4WW4WW4W01
	Indicator expansion	Amber	Amber	E322AAAAAAAAA17
		Green	Green	E322GGGGGGGGG17
		White	Red, Amber, Green, Blue	E322W4WW4WW4W17
16–32V	Master	Amber	Amber	E323AAAAAAAAA01
		Green	Green	E323GGGGGGGGG01
		White	Red, Amber, Green, Blue	E323W4WW4WW4W01
	Expansion	Amber	Amber	E324AAAAAAAAA01
		Green	Green	E324GGGGGGGGG01
		White	Red, Amber, Green, Blue	E324W4WW4WW4W01
	Indicator expansion	Amber	Amber	E324AAAAAAAAA17
		Green	Green	E324GGGGGGGGG17
		White	Red, Amber, Green, Blue	E324W4WW4WW4W17

Accessories

Rockers

Color	Description	Catalog Number
Black	Full-throw actuator	53-7350
	Half-throw up actuator	53-7350-2
	Half-throw down actuator	53-7350-3
Red	Full-throw actuator	53-7350-4
	Half-throw up actuator	53-7350-5
	Half-throw down actuator	53-7350-6
Black	Indicator	53-7354
	Dummy plug	53-7354-2
	Panel plug	17-24241

Circuit Sub-Actuators

Color	Circuit (Up-Middle-Down)			Catalog Number
Black	On	On	None	61-4043
Red	Momentary	On	None	61-4043-2
Light blue	On	On	On	61-4043-3
White	Momentary	On	Momentary	61-4043-4
Yellow	Momentary	On	On	61-4043-5
Gray	On	None	On	61-4043-6
Pink	Momentary	None	On	61-4043-7
Maroon	None	On	On	61-4043-8
Light purple	None	On	Momentary	61-4043-9
Orange	On	On	Momentary	61-4043-10
Green	On	None	Momentary	61-4043-11

1

Wiring

Master Module Wire Harness

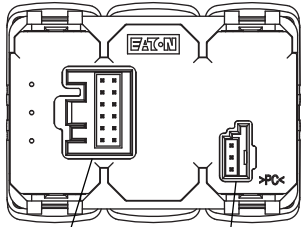

Pin	Function
1	VBAT (clamp 30)
2	Ground
3	CAN high
4	CAN low
5	500 mA output
6	Address 1
7	Address 2
8	Address 3
9	Address 4
10	No connect
11	No connect
12	No connect

Pin	Function
1	VBAT (clamp 30)
2	Ground
3	LIN sub bus

The interconnection between master module and controller uses a simple four-wire harness with addressing specified by jumping between pins 6 to 9. An additional pin-out is provided for a 500 mA output if required.

Mating Connector Information

Housing:

- ETN 28-6982
- Amp/Tyco #1394048-1
- ETN 49-7867
- Amp/Tyco #2-1355524-3

Expansion Module Wire Harness

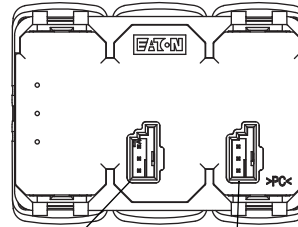

Pin	Function
1	VBAT (clamp 30)
2	Ground
3	LIN sub bus

Pin	Function
1	VBAT (clamp 30)
2	Ground
3	LIN sub bus

The interconnection between modules uses a cost-effective three-wire harness. This simplified wire harness reduces cost, weight and assembly labor for the end-user.

Mating Connector Information

Terminal:

- ETN 28-6983
- Amp/Tyco #1-1718346-1 Coding A
- ETN 80-20608
- Amp/Tyco #963715-1

Master Address Assignment

The master switch module address is set using jumpers in the wire harness to connect the following pins:

Master Address Assignment

Terminal Pins Connected	Address
6-7	A1
6-8	A2
6-9	A3
7-8	A4
7-9	A5
8-9	A6
6-7, 8-9	A7
6-8, 7-9	A8

Manufacturing Flexibility

E32 eSM offers a tremendous amount of flexibility including options for complete assemblies to be provided as well as late-point definable rocker and circuit. Individual components can be purchased independently and assembled to create any combination of circuits and icons which is especially suited for low volume/high mix applications minimizing inventory requirements. Rockers and indicators can also be laser-etched with custom icons by Eaton or other to accommodate application specific requirements. Contact your Eaton representative to discuss the Eaton solution further.

Dimensions

Approximate Dimensions in mm

Mounting Instructions

The modules are easily mounted with plastic retention clips. Modules are mounted in a single, space-saving cutout, reducing assembly time and accommodating up to three switches in a compact design.

The unit will accommodate 1.5 to 3 mm panel thickness.

Mounting Dimensions

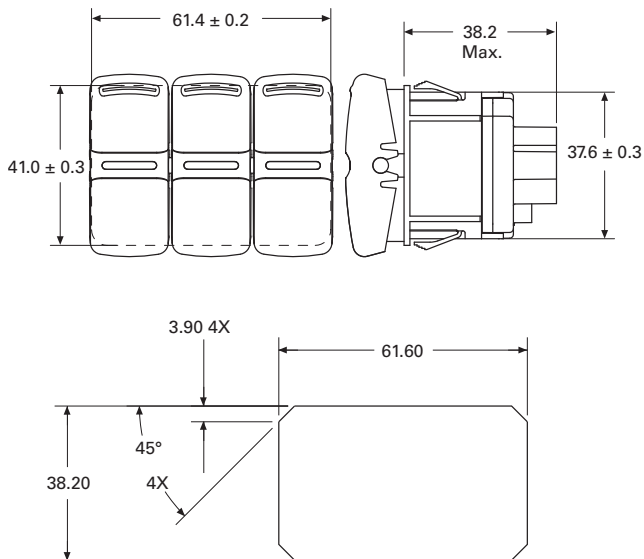



Contents

Description

	<i>Page</i>
E33 eSM—Keypad Multiplexed Switch Module	
Product Selection	V11-T1-22
Wiring	V11-T1-22
Technical Data and Specifications	V11-T1-22
Dimensions	V11-T1-23

Product Description

Sealed Multiplexed Master Module using a LIN sub bus to communicate with up to seven expansion modules.

Eaton is pleased to introduce the newest line of multiplexed electronic Switch Modules (eSM), the E33 product line. The E33 eSM offers an increased level of flexibility over previous modules including:

- Fully sealed to IP68 from the front and rear
- Locking rocker options
- Palm guard option

The E33 eSM offers a complete range of switch circuits as well as indicator options to meet all your control requirements. Similar to the E32 eSM product line, the E33 eSM includes individual icon lighting as well as a multi-color center indicator option allowing for steady state, flashing and dimming controlled via messaging. Additional flexibility is available by using the Eaton IP68 sealed SVR switch line for high-current, hard-wired applications in conjunction with our multiplexed solution.

Compared with electromechanical switches, multiplexed switch modules offer several advantages.

- Reduced assembly labor due to ease of installation, allowing for mounting and connection of three switches at one time versus individually
- Reduced wire harness complexity, using one harness to accommodate up to 24 switches and a three-wire interconnect between expansion and master modules
- Reduced harness size offers an overall reduction in weight, improving operational efficiency of the equipment
- Increase in switch life-cycle over traditional electromechanical switches (500k cycles)
- Reduced connections resulting in less possible failure points

Application Description

Target Market Segments

This product is targeted at harsh environment applications where a ruggedized product is needed to meet demanding requirements. Additionally, applications where there is concern over inadvertent switch actuation driving the need for guarding or locking features are also well-suited. Typical applications include:

- Construction equipment
- Agricultural equipment
- Specialty vehicle
- Material handling
- Emergency vehicle
- School and transit bus

Features and Benefits

- Fully compliant with J1939 CAN 2.0b messaging
- IP68 degree of protection front and rear
- 9–32 Vdc rated
- Immune to SAE J1455 and J1113 power disturbances
- Top, bottom and full guard option available
- Locking rocker available
- Front panel removable for ease of maintenance
- Sleep mode available to reduce current draw on the battery
- Wake on switch change configurable
- LED lighting in top, center-indicator and bottom position
- Decorative style rocker with matching indicator option
- Late point definition of circuit and rockers to reduce inventory
- Diagnostics

Contact your Eaton sales engineer for availability.

Product Selection

Note: All fully-assembled products are custom ordered. Contact your local Eaton Sales Representative.

Wiring

Master/Expansion Module Wire Harness

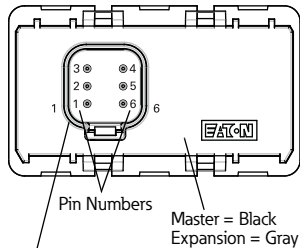

Pin	Master	Expansion
1	VBATT	VBATT
2	Common	Common
3	CAN High	LIN
4	CAN Low	LIN
5	Common	Common
6	LIN	VBATT

The interconnection between master module and controller uses a simple four-wire harness. Addressing of the master can be done by software or via address claim process. Interconnect wiring between master-expansion as well as expansion-expansion uses a three-wire harness.

Mating Connector Information

- Mating connector: Deutsch plug DT06-6S
- Wedge lock: W6S
- Socket contact: 0462-201-16141 (1.0–0.5 mm² [16–20 AWG])
- Hole plug: 0413-217-1605

Technical Data and Specifications

E33 eSM Specifications

Description	Specification
Operating temperature	–40° to 85°C
Storage temperature	–40° to 95°C
Operating voltage	9–32 Vdc
Environmental sealing	IP68
Mechanical shock	30g for 11 ms
Mechanical vibration	MIL-STD-202F/201A 2.0g random
Immunity to SAE J1455 and J1113 power disturbances	
Communication	
Master	SAE J1939 CAN 2.0b
Expansion	LIN 2.0

Contact your Eaton sales engineer for availability.

1

Dimensions

Approximate Dimensions in Inches (mm)

Standard Cut-Out

The modules are easily mounted with plastic retention clips. Modules are mounted in a single, space-saving cutout reducing assembly time and accommodating up to three switches in a compact design.

Serviceability

By modifying the standard cut-out to include the optional front panel removable slots shown below, the modules are easily serviceable from the front of the panel without further disassembly.

Due to the E33's design allowing for late-point definition on assembly, both the actuator and circuit profile are serviceable as individual components.

Standard Cut-Out

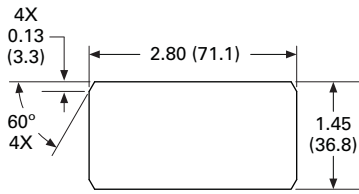

Recommended Panel Opening
Panel Thickness: 0.04–0.16 (1.0–4.0)

Optional Panel Opening Features

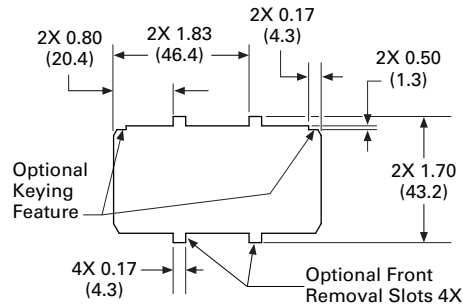

E33 eSM Sealed Multiplexed Rocker Switch Units

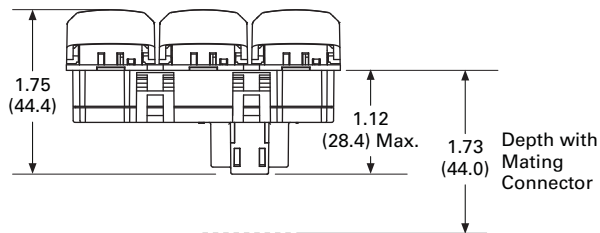
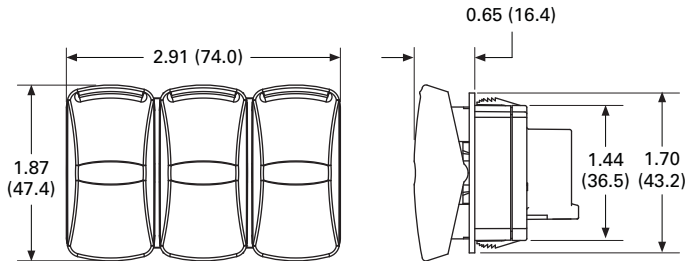

E33 eSM Sealed Multiplexed Rocker Switch Units (Palm Guard Version)

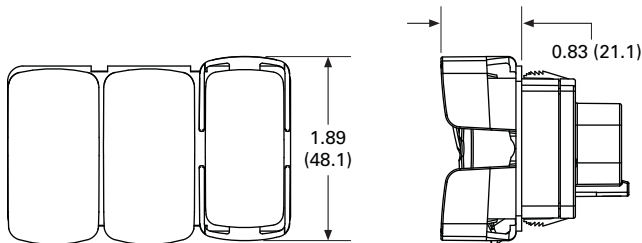

Contact your Eaton sales engineer for availability.

eVu—Electronic Vehicle Display



Product Description

With a focus on communications, convenience and safety, Eaton is pleased to introduce eVu.

Rugged dashpanel displays simplify the viewing, selecting and inputting of key equipment/trip data.

Working in sync with existing controllers and networks, the displays provide the driver with valuable feedback on vehicle status and performance.

eVu displays offer a great deal of flexibility which can include:

- Internal warning/alert buzzer
- Backlighted legend displays
- Sunlight readable LCD characters
- Internal power supply
- Analog or discrete switch inputs
- Up to 2.5 digit character display
- 8-segment bar graph
- Individual LED control

So, what's the e for?

Easy, **e**lectronic and **e**volutionary. eVu fills the gap (literally) between on-board systems and displays, ideal for application-specific functions.

Application Description

Typical applications for information display include:

- Temperature
- Pressure
- Speed
- Distance
- Capacity
- Transmission
- Warnings/alarms
- System information

Safety

eVu displays are easier to access than typical touch screens or soft-key applications. Keeping the dashboard displays within the driver's line of vision helps keep the driver and everyone else on the road safe. Additionally, the eVu displays are designed to meet SAE-1455 specification.

What Do You Want to View?

There are many types of eVu displays and they can be customized with various colors, resolutions and character configurations. Choose the functionality you want with the flexibility you need.

Contents

Description

eVu—Electronic Vehicle Display

Features

Communication and Networking

eVu displays can interface with smart engines, controllers and equipment software via established J1939 and J1708 communication protocols.

In addition, eVu displays can receive input from analog transducers and sub-systems. Analog inputs can be either 0–20 mA or 0–10V. Additional input options exist for up to six logic states.

Designed for Easy Installation

Some advancements in technology create installation obstacles. That isn't the case with eVu. The displays fit into the same cutouts as standard Eaton NGR rocker switches, 0.866 x 1.732 in (22.00 x 44.00 mm), making installation easy. The simplified architecture not only saves dash space, it also saves costs.

Product Selection

Note: All products are custom ordered. Contact your local Eaton Sales Representative.

Dimensions

Approximate Dimensions in mm [in]

Mounting Instructions

Product is designed to mount in panels between 1 to 4 mm (0.039 to 0.157 in) thick.

eVu—Electronic Vehicle Display

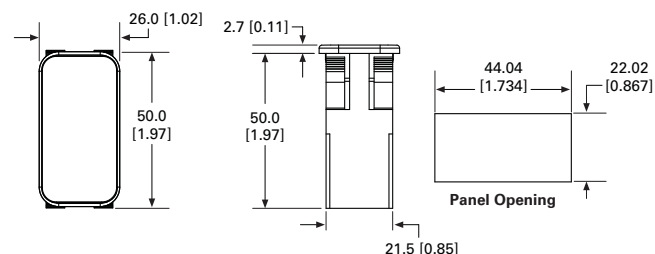

X-ON Electronics

Largest Supplier of Electrical and Electronic Components

Click to view similar products for [Eaton](#) manufacturer:

Other Similar products are found below :

[BK1-S506-2-R](#) [FHN31G1](#) [CH222B](#) [SAMI-2I](#) [SAMI-6I](#) [LPN-RK-25SP](#) [ZE6](#) [ZE9](#) [LPN-RK-15SP](#) [LPN-RK-3SP](#) [SAMI-1I](#) [2499](#) [GMC-500MA](#) [AT-20](#) [BK/SC-45](#) [AGC-1-2](#) [BK/MDA-15](#) [BK/MDA-1](#) [BK/C519-1A](#) [BK/MDL-3-2/10](#) [89096-015](#) [8943K28](#) [8946K153](#) [8961K155](#) [M22-DH-Y](#) [M22-DLH-Y](#) [M22-D-R-GB0/K11](#) [M22-LCH-R](#) [M22-L-R/R](#) [M22-WLK3-B](#) [63ET](#) [6422](#) [6580](#) [CTX20-16-52LP-R](#) [CWL530FI](#) [CXM/CO/GP/R/BB](#) [6HD36](#) [714125](#) [MBO-2](#) [7314K36](#) [7321K2](#) [ETF-200MA](#) [F02A-1-1/2A](#) [F02A-1-1/2AS](#) [F02A-1AS](#) [F02A-3/4A](#) [F03A250V10A](#) [F03A250V12A](#) [MDA-2-8/10-R](#) [MDA-30A](#)