

# TED and YTED (ATEX) Digital pressure switches

For absolute or gauge vacuum and pressure measurements

Two threshold outputs

Thresholds: PNP transistors or galvanic isolation

4...20 mA or Modbus output signal or 0 - 10 V

Totally stainless steel, rugged build for severe industrial environments

300° swivelling version (option)

TED range digital pressure switches are intended for pressure control for industrial process management, such as level management or jack control.

Based on microprocessor technology, the TED can be programmed completely on site using code protected keys.

For use in explosive atmosphere, the YTED is approved ATEX Intrinsically safe Ex ia.

LCIE 03 ATEX 6300X

CE 0081

 I M1  
Ex ia I Ma

 II 1 G  
Ex ia IIC T6 or T5 Ga

Hazardous area : 0, 1, 2

Processing modules for output thresholds and / or 4 ... 20mA signal are also available (ref. data sheet A31.04)

Swivelling version TED



## Specifications (20°C)

\* These characteristics are given for a "basic" TED, as featured on this documentation. When mounting on a chemical seal or any other intermediate part in relation to the process, each component should be taken into account to determine the overall characteristics.

<b>Measurement range</b>	Absolute pressure: 0...1 to 0...400 bar Gauge pressure: -1...0 to 0...400 bar
<b>Display</b>	-1999 to +9999 points. 4 digit red LEDs (8 mm high)
<b>Power supply voltage</b>	<b>TED6-TED7-TEDM:</b> 10 ...32 VDC, regulated. <b>TED5:</b> 18 ...32 VDC, regulated Protection against polarity reversals <b>YTED :</b> 10...28 Vdc regulated
<b>Consumption</b>	<b>YTED-TED6 and TED7 &lt; 22 mA. TED5 :</b> 50 mA max. <b>TEDM :</b> Typ. 20 mA. Communicating : 100 mA
<b>Load impedance</b>	<b>YTED-TED6 and TED7:</b> $R_L \leq (U_{supply} - 10) / 0.02$ <b>TED5:</b> $R_L \leq 400 \Omega$
<b>Output signal</b>	<b>YTED-TED6 and TED7:</b> 4...20 mA (2 wires) <b>TED5:</b> 4...20 mA (3 wires) <b>TEDM:</b> Modbus communication
<b>Threshold outputs</b>	<b>TED6 and TED7:</b> PNP transistors, 400 mA at 24 VDC <b>TED5-TEDM:</b> static relays, 400 mA at 60 VDC or 40 VAC <b>YTED:</b> PNP transistors, 40 mA at 28 VDC
<b>Threshold adjustment range</b>	2% to 98% of the measurement range
<b>Typical response time of the threshold outputs</b>	$\leq 20$ ms
<b>Accuracy</b>	$\pm 0.5\%$ of F.S.
<b>Repeatability</b>	$\pm 0.2\%$ of F.S.
<b>Annual stability</b>	$\leq 0.2\%$ of F.S.
<b>Ambient temperature</b>	<b>YTED:</b> - 25 ... 70°C Ta = +40°C      G: T6 Ta = +70°C      G: T5      (G = Gas/Gaz) <b>Others :</b> -25 ... 85°C
<b>Fluid temperature:</b>	- 25 ... 100°C
<b>Storage temperature:</b>	- 40 ... 85°C
<b>Thermal drift</b>	$\pm 0.015\%$ of F.S. /°C max.

<b>Materials in contact with the fluid</b>	Ceramic, 1.4404 (316L) stainless steel, NBR seal (standard)
<b>Connections</b>	<b>Electrical:</b> <b>TED6-TED7 and YTED:</b> M12-5 pin connector male <b>TED5-TEDM:</b> M12-8 pin connector
<b>Connections</b>	<b>Pressure:</b> G 1/2 EN837, G 1/4 EN837, G1/4 DIN 3852, G1/4 female, 1/2 NPT, 1/4 NPT, M20x1.5 Aseptic union: on request
<b>IP rating (EN 60 529)</b>	IP 67
<b>CE conformity</b>	EMC directive 89/336 CE PED pressure directive 97/23/CE ATEX 94/9/CE
<b>Resistance to vibrations (EN 60068-2-6)</b>	1.5 mm (10 Hz ... 55 Hz) / 20 g (55 Hz ... 2 kHz)
<b>Resistance to shocks (EN 60028-2-32)</b>	25 drops from 1 meter onto a concrete floor
<b>Weight</b>	530 g to 580 g depending on the version

### Options

300° swivelling version. **Code 2037**  
Drinking water application. **Code 0619**  
Oxygen application ( $\leq 320$  bar). **Code 0765**  
Specific cleaning (gas application). **Code 0829**  
Thread locking. **Code 0771**  
10 mm dia. hole in the connection (for G1/2, 1/2NPT, M10x1.5 connection). **Code 9022**  
Capacitive cell (except YTED). **Code 0591**  
Mobile plugs and cables. See page 3  
G1/2 mounted on chemical seals. **Code 0592**

 **Baumer**

## TED range – Description

### Digital pressure switch range

- **TED7** 0 - 10 V output
- **TED6** Digital 2 threshold pressure switch, 4...20 mA output
- **TED5** Galvanically isolated digital 2 threshold pressure switch, 4...20 mA output
- **TEDM** Galvanically isolated digital 2 threshold pressure switch, Modbus communication
- **YTED** Digital 2 threshold pressure switch, 4...20 mA output.  
ATEX Ex ia intrinsic safety approval

### Version with galvanically isolated digital thresholds – TED5 and TEDM

The current supply to the pressure switch is electrically isolated from the threshold outputs and the threshold outputs are isolated from each other. It is possible to have a separate power supply between the TEDM (32 VDC max.) and the threshold contacts (60 VDC max. or 40 VAC max.)

### Modbus communication

The TEDM has a RS485 serial port and uses the Modbus RTU communication protocol.

The Modbus protocol is a two-way exchange protocol based on a hierarchical data base structure between a master and multiple slaves (stations). It enables the user to read the pressure and the status of each threshold (open or closed). Exchange between the master and one slave: the master sends an order and waits for a reply.

Exchange between the master and all slave stations: the master broadcasts a message to all the slaves in the network and they perform the order in the message without sending a reply.

Two slave stations cannot talk together.

The bus stations are identified by addresses given by the user.

These addresses range from 1 to 247.

## Parameter configuration and consultation

### Parameter configuration mode

The three keys on the front panel are used to configure the following operating parameters:

- switching point value for each threshold
- Bottom switching point value for each threshold
- Active status for each threshold (NO or NC)
- Time delay of each threshold from 0 to 25 s in 0.1 s steps
- Auto-zero function
- Self test and parameter protection by a 4 digit code

Additional parameter for the TEDM:

- Modbus slave address of the pressure switch
- Parity selection

### Parameter consultation mode

For each threshold, parameters can be viewed without access code, as modbus adresse and parity for TEDM.

### Max. and min. value consultation

When the pressure switch is in the measurement mode it is possible to display or initialise the max. and min. pressure values saved at any time.

## Dimensional drawing (mm)

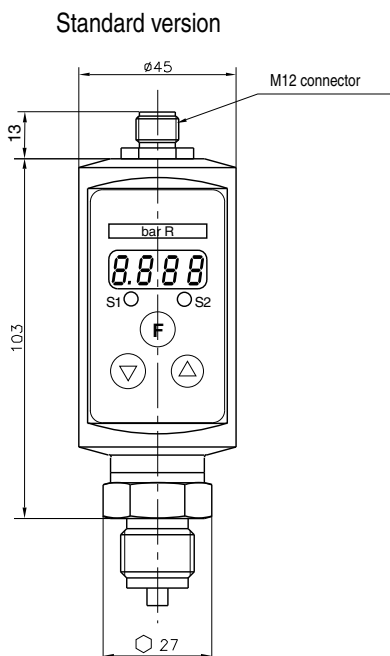

Swivelling version. Option code 0622

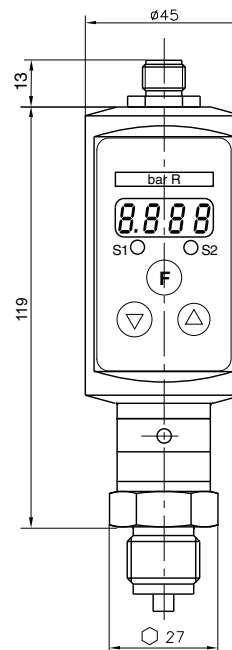

### Pressure connections

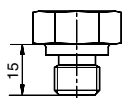

G 1/4 DIN 3852-E

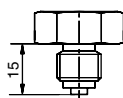

G 1/4 EN837

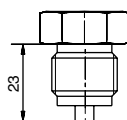

G 1/2 EN837

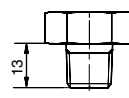

1/4 NPT EN837

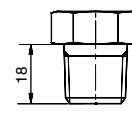

1/2 NPT EN837

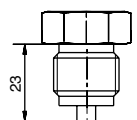

M 20 x 1.5

## Connection diagrams

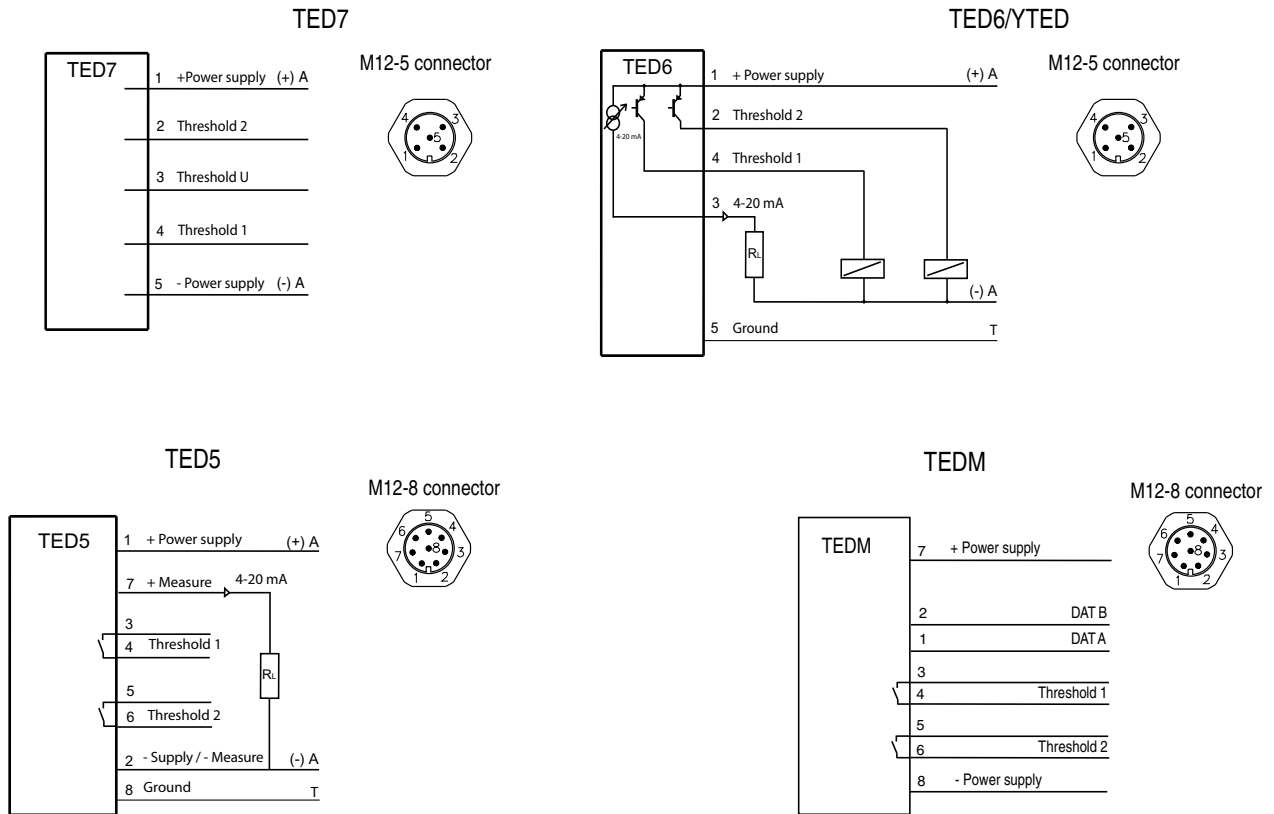

## Installations YTED

**Hazardous area**  
(0, 1, 2)

**Non hazardous area**

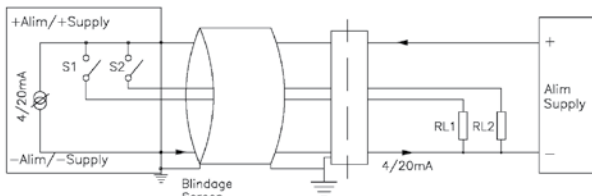

$U_{max} = 28 \text{ Vcc}$   
 $I_{max} = 120 \text{ mA}$   
 $P = 0,8 \text{ W}$

$C_i = 13,2 \text{ nF}$   
 $L_i = 0$

**Important :**

In area 0, the combination of the pressure switch and the safety barrier must be covered by a calculation checked by an approved body.

We offer a system of pressure switch + safety module + cable already certified by an approved body: see next page. : see data sheet A31.04 "YTED-YTTN ATEX Ex ia approved system".

## Accessories

Model	Description	Code
	M12-5 pin mobile plug, screw terminal connection	<b>2260</b>
	Shielded moulded M12-5 pin cable, length 2 m	<b>0604</b>
	Shielded moulded M12-5 pin cable, length 5 m	<b>0605</b>
	Shielded moulded M12-5 pin cable, length 10 m	<b>0606</b>
	Shielded moulded M12-8 pin cable, length 2 m	<b>0607</b>
	Shielded moulded M12-8 pin cable, length 5 m	<b>0608</b>
	Shielded moulded M12-8 pin cable, length 10 m	<b>0609</b>

Important: TED series pressure switches have a immunity against high frequency interference. In environments with a high radiation (eg.GSM), we recommend to use screened cable.

## Measuring ranges (bar)

Measurement range	-1 +0	-1 +0.6	-1 +1.5	-1 +3	-1 +5	-1 +9	-1 +15	-1 +24	-1 +39
Max. over pressure	3	3	4	8	12	20	32	50	80
Burst pressure	6	6	7	12	18	30	48	75	120
Display at Measurement range	-1.000 / 0	-1.000 / 0.600	-1.000 / 1.500	-1.000 / 3.000	-1.000 / 5.000	-1.000 / 9.000	-1.00 / 15.00	-1.00 / 24.00	-1.00 / 39.00

Measurement range	0 +1	0 +1.6	0 +2.5	0 +4	0 +6	0 +10	0 +16	0 +25	0 +40	0 +60	0 +100	0 +160	0 +250	0 +400
Max. over pressure	3	3	4	8	12	20	32	50	80	120	200	320	500	600
Burst pressure	7	7	7	12	18	30	48	75	120	180	300	480	600	800
Display at Measurement range	0 / 1.000	0 / 1.600	0 / 2.500	0 / 4.000	0 / 6.000	0 / 10.00	0 / 16.00	0 / 25.00	0 / 40.00	0 / 60.00	0 / 100.0	0 / 160.0	0 / 250.0	0 / 400.0

## Ordering details – TED

Type	1'...4' digits	XXXXXXXXXX
Digital 2 threshold pressure switch, 4...20 mA output	TED6	
Digital 2 galvanically isolated threshold pressure switch, 4...20 mA output	TED5	
Digital 2 threshold pressure switch, Modbus communication	TEDM	
Digital 2 threshold pressure switch, 0 - 10 V output	TED7	
Digital 2 threshold pressure switch, 4...20 mA output, ATEX Ex ia intrinsic safety	YTED*	
<b>Pressure connection</b> 5' digits		
G1/4	2	
G1/4 DIN 3852	B	
G 1/4 female	H	
G1/2	3	
1/4 NPT	5	
1/2 NPT	6	
M20x1,5	9	
<b>Sensor seal</b> 6' digits		
NBR (nitrile) standard	3	
EPDM	5	
FFKM Chemraz® 505	7	
FKM (Viton®)	9	
<b>Measuring ranges</b> 7'...9' digits		
bar	Bxx	
kPa	Dxx	
kg/cm <sup>2</sup>	Fxx	
psi	Hxx	
<b>Pressure mode</b> 10' digits		
Absolute	A	
Gauge	R	

code	bar kg/cm <sup>2</sup>	kPa	code	psi	A - R
59	-1 + 0	-100 + 0	59	-30"Hg + 0	- R
72	-1 + 0.6	-100 + 60	73	-30"Hg + 15	- R
74	-1 + 1.5	-100 + 150	75	-30"Hg + 30	- R
76	-1 + 3	-100 + 300	2C	-30"Hg + 60	- R
77	-1 + 5	-100 + 500	78	-30"Hg + 100	- R
79	-1 + 9	-100 + 900	79	-30"Hg + 150	- R
81	-1 + 15	-100 + 1500	81	-30"Hg + 220	- R
82	-1 + 24	-100 + 2400	82	-30"Hg + 300	- R
1L	-1 + 39	-100 + 3900	1L	-30"Hg + 600	- R
15	0 + 1	0 + 100	15	0 + 15	A R
16	0 + 1.6	0 + 160	1C	0 + 20	A R
18	0 + 2.5	0 + 250	17	0 + 30	A R
19	0 + 4	0 + 400	19	0 + 60	A R
20	0 + 6	0 + 600	21	0 + 100	A R
22	0 + 10	0 + 1000	22	0 + 160	A R
24	0 + 16	0 + 1600	23	0 + 200	A R
26	0 + 25	0 + 2500	25	0 + 300	A R
27	0 + 40	0 + 4000	26	0 + 400	A R
29	0 + 60	0 + 6000	27	0 + 600	A R
31	0 + 100	0 + 10000	30	0 + 1000	A R
33	0 + 160	0 + 16000	31	0 + 1500	A R
35	0 + 250	0 + 25000	34	0 + 3000	A R
38	0 + 400	0 + 40000	38	0 + 6000	A R

\* See data sheet A31.04 "YTED-YTTN ATEX Ex ia approved system".

## Curve showing change of threshold state

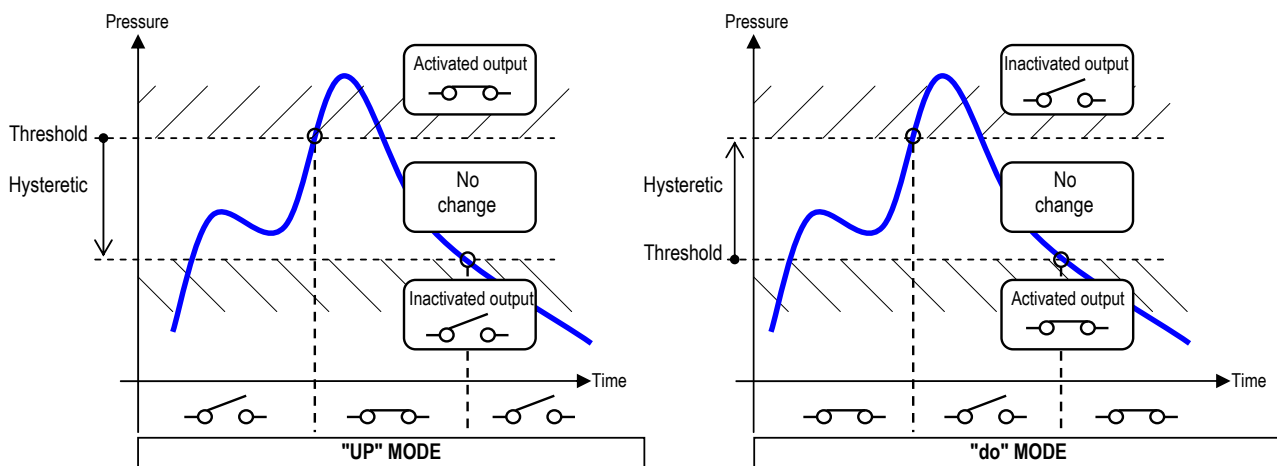

# X-ON Electronics

Largest Supplier of Electrical and Electronic Components

*Click to view similar products for [Industrial Pressure Sensors](#) category:*

*Click to view products by [Baumer](#) manufacturer:*

Other Similar products are found below :

[76053-00000400-01](#) [M83723/72R2041N L/C](#) [M83723/76R2219N](#) [D38999/20ME6BN](#) [75380-05](#) [76053-00000300-01](#) [76053-00000300-05](#) [76061-00000015-01](#) [76062-B00000350-01](#) [76063-00000350-05](#) [76083-05000500-01](#) [76311-05](#) [76577-00000070-01](#) [76584-M00000100-24](#) [77050-04000400-01](#) [77343-24.0H2-01](#) [77343-25.0H2-01](#) [78291-B00000060-01](#) [78303-B00000400-01](#) [78303-B00000400-05](#) [78316-B00000030-01](#) [78665-00000014-05](#) [78678-00000040-01](#) [78928-00000040-01](#) [79279-00000060-01](#) [79296-B00000350-01](#) [79322-00250035-01](#) [79614-30.0H2-14](#) [79670-00000090-15](#) [79700-00002750-01](#) [79917-B00000280-01](#) [80569-00700100-01](#) [81509081](#) [MLH010BST01A](#) [MLH010BST14A](#) [MLH025BGC13B](#) [MLH025BSCDJ1292](#) [MLH025BSCDJ1303](#) [MLH750PSCDJ1245](#) [83250-02500600-05](#) [83271-00000040-04](#) [83276-B00000250-05](#) [83278-B00000200-21](#) [83282-00000100-05](#) [83286-00000150-01](#) [83298-00000120-01](#) [83299-00000150-05](#) [83303-00000600-01](#) [83305-00001350-01](#) [83330-00000100-01](#)