



TOBY-R2 series

Multi-mode LTE Cat 1 modules with 2G/3G fallback

Data Sheet



Abstract

Technical data sheet describing TOBY-R2 series multi-mode cellular modules. The modules are a cost efficient and performance optimized LTE Cat 1/ 3G/ 2G multi-mode solution covering up to four LTE bands, up to four 3G UMTS/HSPA bands, and up to four 2G GSM/EDGE bands in the compact TOBY form factor.

Document Information

| | | |
|-------------------------------|--|-------------|
| Title | TOBY-R2 series | |
| Subtitle | Multi-mode LTE Cat 1 modules with 2G/3G fallback | |
| Document type | Data Sheet | |
| Document number | UBX-16005785 | |
| Revision and date | R12 | 07-Dec-2018 |
| Disclosure Restriction | | |

| Product status | Corresponding content status | |
|--------------------------------------|-------------------------------------|--|
| Functional Sample | Draft | For functional testing. Revised and supplementary data will be published later. |
| In Development / Prototype | Objective Specification | Target values. Revised and supplementary data will be published later. |
| Engineering Sample | Advance Information | Data based on early testing. Revised and supplementary data will be published later. |
| Initial Production | Early Production Information | Data from product verification. Revised and supplementary data may be published later. |
| Mass Production / End of Life | Production Information | Document contains the final product specification. |

This document applies to the following products:

| Product name | Type number | Modem version | Application version | PCN reference | Product status |
|---------------------|--------------------|----------------------|----------------------------|----------------------|-----------------------|
| TOBY-R200 | TOBY-R200-02B-00 | 30.31 | A01.01 | UBX-17006265 | End of Life |
| | TOBY-R200-02B-01 | 30.31 | A02.00 | UBX-17048314 | End of Life |
| | TOBY-R200-02B-02 | 30.31 | A02.01 | UBX-18018067 | End of Life |
| | TOBY-R200-02B-03 | 30.31 | A02.02 | UBX-18057549 | Mass Production |
| TOBY-R202 | TOBY-R202-02B-00 | 30.31 | A01.01 | UBX-17006265 | End of Life |
| | TOBY-R202-02B-01 | 30.31 | A02.00 | UBX-17048314 | End of Life |
| | TOBY-R202-02B-02 | 30.31 | A02.01 | UBX-18018067 | End of Life |
| | TOBY-R202-02B-03 | 30.31 | A02.02 | UBX-18057549 | Mass Production |

u-blox or third parties may hold intellectual property rights in the products, names, logos and designs included in this document. Copying, reproduction, modification or disclosure to third parties of this document or any part thereof is only permitted with the express written permission of u-blox.

The information contained herein is provided "as is" and u-blox assumes no liability for its use. No warranty, either express or implied, is given, including but not limited to, with respect to the accuracy, correctness, reliability and fitness for a particular purpose of the information. This document may be revised by u-blox at any time without notice. For the most recent documents, visit www.u-blox.com.

Copyright © u-blox AG.

Contents

| | |
|--|-----------|
| Document Information | 2 |
| Contents | 3 |
| 1 Functional description | 5 |
| 1.1 Overview..... | 5 |
| 1.2 Product features | 5 |
| 1.3 Block diagram | 6 |
| 1.4 Product description | 7 |
| 1.5 AT command support | 7 |
| 1.6 Supported features | 8 |
| 2 Interfaces | 10 |
| 2.1 Power management | 10 |
| 2.1.1 Module supply input (VCC) | 10 |
| 2.1.2 RTC supply input / output (V_BCKP) | 10 |
| 2.1.3 Generic digital interfaces supply output (V_INT) | 10 |
| 2.2 Antenna interfaces..... | 10 |
| 2.2.1 Antenna RF interfaces..... | 10 |
| 2.2.2 Antenna detection..... | 10 |
| 2.3 System functions..... | 11 |
| 2.3.1 Module power-on | 11 |
| 2.3.2 Module power-off..... | 11 |
| 2.3.3 Module reset | 12 |
| 2.3.4 Module / host configuration selection..... | 12 |
| 2.4 SIM | 12 |
| 2.4.1 SIM interface | 12 |
| 2.4.2 SIM detection | 12 |
| 2.5 Serial communication | 12 |
| 2.5.1 UART interface..... | 13 |
| 2.5.2 USB interface..... | 14 |
| 2.5.3 DDC (I ² C) interface..... | 15 |
| 2.5.4 SDIO interface | 15 |
| 2.6 Audio..... | 15 |
| 2.7 Clock output..... | 15 |
| 2.8 GPIO | 16 |
| 3 Pin definition | 17 |
| 3.1 Pin assignment..... | 17 |
| 4 Electrical specifications | 22 |
| 4.1 Absolute maximum rating..... | 22 |
| 4.1.1 Maximum ESD..... | 22 |
| 4.2 Operating conditions..... | 23 |
| 4.2.1 Operating temperature range..... | 23 |
| 4.2.2 Supply/power pins | 23 |
| 4.2.3 Current consumption..... | 24 |

| | | |
|--------------------------|--|-----------|
| 4.2.4 | LTE RF characteristics | 25 |
| 4.2.5 | 3G RF characteristics | 26 |
| 4.2.6 | 2G RF characteristics | 26 |
| 4.2.7 | ANT_DET pin..... | 27 |
| 4.2.8 | PWR_ON pin..... | 27 |
| 4.2.9 | RESET_N pin..... | 27 |
| 4.2.10 | SIM pins | 28 |
| 4.2.11 | USB pins | 28 |
| 4.2.12 | DDC (I ² C) pins..... | 28 |
| 4.2.13 | Generic Digital Interfaces pins | 29 |
| 5 | Mechanical specifications | 31 |
| 6 | Qualification and approvals..... | 32 |
| 6.1 | Reliability tests..... | 32 |
| 6.2 | Approvals..... | 32 |
| 7 | Product handling & soldering..... | 33 |
| 7.1 | Packaging | 33 |
| 7.1.1 | Reels | 33 |
| 7.1.2 | Tapes..... | 34 |
| 7.2 | Moisture Sensitivity Levels..... | 35 |
| 7.3 | Reflow soldering | 35 |
| 7.4 | ESD precautions..... | 35 |
| 8 | Default settings | 36 |
| 9 | Labeling and ordering information | 37 |
| 9.1 | Product labeling..... | 37 |
| 9.2 | Explanation of codes | 37 |
| 9.3 | Ordering information..... | 38 |
| Appendix | | 39 |
| Related documents | | 42 |
| Revision history | | 43 |
| Contact | | 44 |

1.3 Block diagram

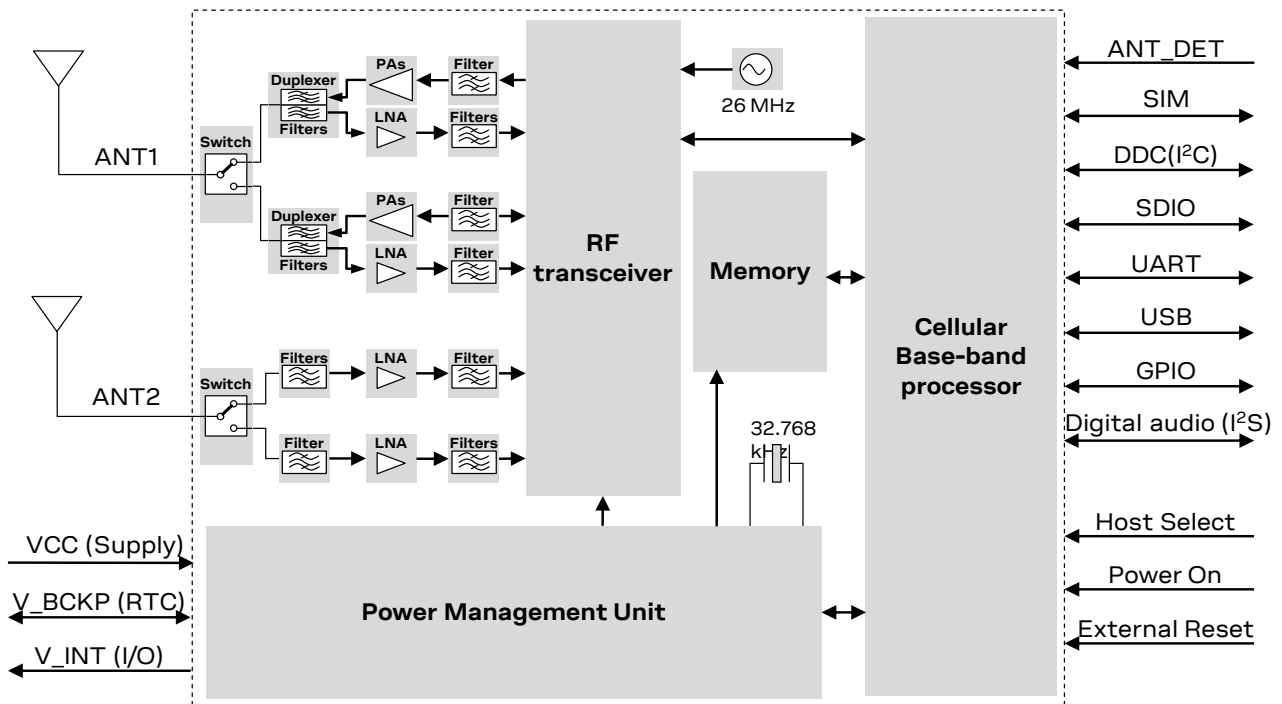

Figure 1: TOBY-R2 series block diagram

TOBY-R200-02B and TOBY-R202-02B modules, i.e. the “02” product versions, do not support the following interfaces, which can be left unconnected and should not be driven by external devices:

- SDIO interface
- HOST_SELECTx pins

1.4 Product description

TOBY-R2 modules provide 4G LTE Cat 1, 3G UMTS / HSPA, 2G GSM/(EGPRS) multi-mode technology:

- TOBY-R200 is designed for worldwide operation, and primarily in North America (on the AT&T network)
- TOBY-R202 is designed primarily for operation in North America (on the AT&T network)

| 4G LTE | 3G UMTS/HSDPA/HSUPA | 2G GSM/GPRS/EDGE |
|---|--|---|
| 3GPP Release 9 | 3GPP Release 9 | 3GPP Release 9 |
| Long Term Evolution (LTE) | High Speed Packet Access (HSPA) | Enhanced Data rate GSM Evolution (EDGE) |
| Evolved Univ. Terrestrial Radio Access (E-UTRA) | UMTS Terrestrial Radio Access (UTRA) | GSM EGPRS Radio Access (GERA) |
| Frequency Division Duplex (FDD) | Frequency Division Duplex (FDD) | Time Division Multiple Access (TDMA) |
| DL Rx Diversity | DL Rx Diversity | DL Advanced Rx Performance Phase 1 |
| Band support ² : | Band support: | Band support: |
| TOBY-R200: | TOBY-R200: | TOBY-R200: |
| <ul style="list-style-type: none"> • Band 12 (700 MHz)³ • Band 5 (850 MHz) • Band 4 (1700 MHz) • Band 2 (1900 MHz) | <ul style="list-style-type: none"> • Band 5 (850 MHz) • Band 8 (900 MHz) • Band 2 (1900 MHz) • Band 1 (2100 MHz) | <ul style="list-style-type: none"> • GSM 850 MHz • E-GSM 900 MHz • DCS 1800 MHz • PCS 1900 MHz |
| TOBY-R202: | TOBY-R202: | |
| <ul style="list-style-type: none"> • Band 12 (700 MHz)³ • Band 5 (850 MHz) • Band 4 (1700 MHz) • Band 2 (1900 MHz) | <ul style="list-style-type: none"> • Band 5 (850 MHz) • Band 2 (1900 MHz) | |
| LTE Power Class | UMTS/HSDPA/HSUPA Power Class | GSM/GPRS (GMSK) Power Class |
| <ul style="list-style-type: none"> • Class 3 (23 dBm) | <ul style="list-style-type: none"> • Class 3 (24 dBm) | <ul style="list-style-type: none"> • Class 4 (33 dBm) for GSM/E-GSM band • Class 1 (30 dBm) for DCS/PCS band |
| | | EDGE (8-PSK) Power Class |
| | | <ul style="list-style-type: none"> • Class E2 (27 dBm) for GSM/E-GSM band • Class E2 (26 dBm) for DCS/PCS band |
| Data rate | Data rate | Data rate ⁴ |
| <ul style="list-style-type: none"> • LTE category 1: up to 10.3 Mb/s DL, 5.2 Mb/s UL | <ul style="list-style-type: none"> • HSDPA category 8: up to 7.2 Mb/s DL • HSUPA category 6: up to 5.76 Mb/s UL | <ul style="list-style-type: none"> • GPRS multi-slot class 33⁵, CS1-CS4, up to 107 kb/s DL, up to 85.6 kb/s UL • EDGE multi-slot class 33⁵, MCS1-MCS9, up to 296 kb/s DL, up to 236.8 kb/s UL |

Table 2: TOBY-R2 series LTE, 3G and 2G characteristics

TOBY-R2 modules provide Voice over LTE (VoLTE) as well as Circuit-Switched-Fall-Back (CSFB) audio capability.

1.5 AT command support

The TOBY-R2 series modules support AT commands according to 3GPP standards TS 27.007 [8], TS 27.005 [9] and the u-blox AT command extension.

² TOBY-R2 series modules support all the E-UTRA channel bandwidths for each operating band as per 3GPP TS 36.521-1 [11]:

- Band 12: 1.4 MHz, 3 MHz, 5 MHz, 10 MHz
- Band 5: 1.4 MHz, 3 MHz, 5 MHz, 10 MHz
- Band 4: 1.4 MHz, 3 MHz, 5 MHz, 10 MHz, 15 MHz, 20 MHz
- Band 2: 1.4 MHz, 3 MHz, 5 MHz, 10 MHz, 15 MHz, 20 MHz

³ LTE band 12 is a superset that includes band 17: the LTE band 12 is supported along with Multi-Frequency Band Indicator (MFBI) feature

⁴ GPRS/EDGE multi-slot class determines the number of timeslots available for upload and download and thus the speed at which data can be transmitted and received, with higher classes typically allowing faster data transfer rates.

⁵ GPRS/EDGE multi-slot class 33 implies a maximum of 5 slots in DL (reception) and 4 slots in UL (transmission) with 6 slots in total.

 For the complete list of all supported AT commands and their syntax, see the u-blox AT Commands Manual [1].

RIL (Radio Interface Layer) software for Android and Embedded Windows is available for TOBY-R2 series modules free of charge; see the Android RIL Production delivery [3] and Windows Embedded RIL Production delivery [4] application notes for supported software deliveries and more information.

1.6 Supported features

Table 3 lists some of the main features supported by TOBY-R2 modules. For more details, see TOBY-R2 series System Integration Manual [2] and u-blox AT Commands Manual [1].

| Feature | Description |
|---|--|
| Network Indication | GPIO configured to indicate the network status: registered home network, registered roaming, voice or data call enabled, no service. The feature can be enabled through the +UGPIOC AT command. |
| Antenna Detection | The ANT_DET pin provides antenna presence detection capability, evaluating the resistance from ANT1 and ANT2 pins to GND by means of an external antenna detection circuit implemented on the application board. The antenna detection feature can be enabled through the +UANTR AT command. |
| Jamming detection ⁶ | Detects “artificial” interference that obscures the operator’s carriers entitled to give access to the radio service and reports the start and stop of such conditions to the application processor, which can then react accordingly. |
| Embedded TCP and UDP stack | Embedded TCP/IP and UDP/IP stack including direct link mode for TCP and UDP sockets. Sockets can be set in Direct Link mode to establish a transparent end to end communication with an already connected TCP or UDP socket via serial interface. |
| FTP, FTPS | File Transfer Protocol as well as Secure File Transfer Protocol (SSL encryption of FTP control channel) functionalities are supported via AT commands. |
| HTTP, HTTPS | AT commands support Hyper-Text Transfer Protocol and Secure Hyper-Text Transfer Protocol (SSL encryption) functionalities. HEAD, GET, POST, DELETE and PUT operations are available. |
| Embedded TLS 1.2 | With the support of X.509 certificates, Embedded TLS 1.2 provides server and client authentication, data encryption, data signature and enables TCP/IP applications like HTTPS and FTPS to communicate over a secured and trusted connection. The feature can be configured and enabled by +USECMNG and +USECPRF AT commands. |
| DNS | Support for DNS functionality. |
| IPv4/IPv6 dual-stack | Capability to move between IPv4 and dual stack network infrastructures. IPv4 and IPv6 addresses can be used. |
| BIP | Bearer Independent Protocol for Over-the-Air SIM provisioning. The data transfer to/from the SIM uses either an already active PDP context or a new PDP context established with the APN provided by the SIM card. |
| Multiple PDP contexts | Up to 8 PDP contexts can be activated, and multi secondary PDP contexts be associated to a primary PDP context |
| VoLTE and CSFB | Voice over LTE (VoLTE) feature allows voice service over LTE bearer, via embedded IP Multimedia Subsystem (IMS) Circuit Switched Fall-Back (CSFB) feature allows voice service over circuit switched infrastructure (3G/2G) |
| Firmware update Over AT commands (FOAT) | Firmware module update Over AT command interfaces. The feature can be enabled and configured through the +UFWUPD AT command. |
| Firmware update Over The Air (FOTA) | Embedded FOTA client to enable the Firmware module update over the cellular air interface. The feature can be enabled and configured through the +UFWINSTALL AT command. |
| LTE / 3G Rx Diversity | Improved cellular link quality and reliability on all operating bands, by means of 2 receiving antenna inputs. |
| GNSS via modem ⁷ | Full access to u-blox positioning chips and modules is available through a dedicated DDC (I ² C) interface. This means that from any host processor a single serial port can control the cellular module |

⁶ Not supported by “02” product versions.

⁷ Not supported by TOBY-R200-02B-00 and TOBY-R202-02B-00



| Feature | Description |
|--|--|
| | and the positioning chip or module. For more details, see the GNSS Implementation Application Note [5]. |
| Embedded AssistNow Software ⁷ | Embedded AssistNow Online and AssistNow Offline clients are available to provide better GNSS performance and faster Time-to-First-Fix. An AT command can enable / disable the clients. |
| CellLocate ^{®7} | Enables the estimation of device position based on the parameters of the mobile network cells visible to the specific device based on the CellLocate [®] database: <ul style="list-style-type: none"> • Normal scan: only the parameters of the visible home network cells are sent CellLocate [®] is available via a set of AT commands for CellLocate [®] service configuration and position request. |
| Hybrid Positioning ⁷ | The current module position is provided by a u-blox positioning chip or module or the estimated position from CellLocate [®] depending on which method provides the best and fastest solution according to the user configuration. Hybrid positioning is available via a set of AT commands that allow the configuration and the position request. |
| Wi-Fi via modem ⁸ | Full access to Wi-Fi modules is available through a dedicated SDIO interface. This means that from any host processor a single serial port can control the cellular module and the short range communication module. |
| DTMF decoder | During a voice call, the Dual-Tone Multi-Frequency detector analyses the RX speech (coming from remote party). The detected DTMF symbols can be output via the related URC. The feature can be enabled and configured through the +UDTMFD AT command. |
| Smart Temperature Supervisor | Constant monitoring of the module board temperature: <ul style="list-style-type: none"> • Warning notification when the temperature approaches an upper or lower predefined threshold • Shutdown notified and forced when the temperature value is outside the specified range (shutdown suspended in case of an emergency call in progress) The Smart Temperature Supervisor feature can be enabled and configured through the +USTS AT command.  The sensor measures board temperature, which can differ from ambient temperature. |
| Power saving | The power saving configuration is by default disabled, but it can be enabled and configured using the +UPSV AT command. When the power saving is enabled, the module automatically enters the low power idle-mode whenever possible, reducing current consumption. During idle-mode, the module processor core runs with the RTC 32 kHz reference clock, which is generated by the internal 32 kHz oscillator. |
| Fast Dormancy | The Fast Dormancy feature, defined in 3GPP Rel.8, allows reduction of current consumption and network utilization during periods of data inactivity. It can be activated and configured by +UFDAC and +UDCONF=61 AT commands. |
| LTE cDRX | Both the Long DRX Cycle and the Short DRX cycle are supported for LTE Connected Discontinuous Reception, allowing reduction of current consumption and LTE network utilization during periods of data inactivity |

Table 3: Some of the main features supported by TOBY-R2 series modules

 u-blox is extremely mindful of user privacy. When a position is sent to the CellLocate[®] server u-blox is unable to track the SIM used or the specific device.

⁸ Not supported by "02" product versions

2 Interfaces

2.1 Power management

2.1.1 Module supply input (VCC)

TOBY-R2 series modules must be supplied through the three **VCC** pins by a DC power supply. Voltage must be stable, because during operation the current drawn from **VCC** can vary by some order of magnitude, especially due to the surging consumption profile of the GSM system (described in the TOBY-R2 series System Integration Manual [2]). It is important that the system power supply circuit is able to support peak power.

TOBY-R200 modules provide separate supply inputs over the three **VCC** pins:

- **VCC** pins #71 and #72 represent the supply input for the internal RF power amplifier, demanding most of the total current drawn by the module when RF transmission is enabled during a voice/data call
- **VCC** pin #70 represents the supply input for the internal baseband Power Management Unit and the internal transceiver, demanding minor part of the total current drawn by the module when RF transmission is enabled during a voice/data call

2.1.2 RTC supply input / output (V_BCKP)

When **VCC** voltage is within the valid operating range, the internal Power Management Unit (PMU) supplies the Real Time Clock (RTC) and the same supply voltage is available on the **V_BCKP** pin. If the **VCC** voltage is under the minimum operating limit (e.g. during not powered mode), the **V_BCKP** pin can externally supply the RTC.

2.1.3 Generic digital interfaces supply output (V_INT)

TOBY-R2 series modules provide a 1.8 V supply rail output on the **V_INT** pin, which is internally generated when the module is switched on. The same voltage domain is used internally to supply the generic digital interfaces of the modules. The **V_INT** supply output can be used in place of an external discrete regulator.

2.2 Antenna interfaces

2.2.1 Antenna RF interfaces

The modules have two RF pins with a characteristic impedance of 50 Ω . The primary antenna pin (**ANT1**) supports both Tx and Rx, providing the main antenna interface, while the secondary antenna pin (**ANT2**) supports Rx only for the LTE / 3G Rx diversity configuration.

2.2.2 Antenna detection

The **ANT_DET** pin is an Analog to Digital Converter (ADC) input with a current source provided by TOBY-R2 modules to sense the antenna presence (as an optional feature). It evaluates the resistance from **ANT1** and **ANT2** pins to GND by means of an external antenna detection circuit implemented on the application board. For more details, see the TOBY-R2 series System Integration Manual [2] and the u-blox AT Commands Manual [1].

2.3 System functions

2.3.1 Module power-on

TOBY-R2 series can be switched on in one of the following ways:

- Rising edge on the **VCC** pins to a valid voltage for module supply, i.e. applying module supply: the modules switch on if the **VCC** supply is applied, starting from a voltage value of less than 2.1 V, with a rise time from 2.3 V to 2.8 V of less than 4 ms, reaching a proper nominal voltage value within **VCC** operating range.

Alternately, in case for example the fast rise time on **VCC** rising edge cannot be guaranteed by the application, TOBY-R2 series modules can be switched on from not-powered mode as following:

- **RESET_N** input pin is held low by the external application during the **VCC** rising edge, so that the modules will switch on when the external application releases the **RESET_N** input pin from the low logic level after the **VCC** supply voltage stabilizes at its proper nominal value within the operating range
- **PWR_ON** input pin is held low by the external application during the **VCC** rising edge, so that the modules will switch on when the external application releases the **PWR_ON** input pin from the low logic level after the **VCC** supply voltage stabilizes at its proper nominal value within the operating range

When the TOBY-R2 series modules are in the power-off mode (i.e. properly switched off as described in section 2.3.2, with valid **VCC** module supply applied), they can be switched on as follows:

- Low pulse on the **PWR_ON** pin, which is normally set high by an internal pull-up, for a valid time period (see section 4.2.8). The **PWR_ON** line should be driven by open drain, open collector or contact switch.
- Rising edge on the **RESET_N** pin, i.e. releasing the pin from the low level, normally set high by an internal pull-up. The **RESET_N** line should be driven by open drain, open collector or contact switch.
- RTC alarm, i.e. pre-programmed scheduled time by AT+CALA command.

2.3.2 Module power-off

TOBY-R2 series can be properly switched off, saving current parameter settings in the module's non-volatile memory and performing a proper network detach, by:

- AT+CPWROFF command (see the u-blox AT Commands Manual [1]).
- Low pulse on the **PWR_ON** pin, which is normally set high by an internal pull-up, for a valid time period (see section 4.2.8). The **PWR_ON** line should be driven by open drain, open collector or contact switch.

An abrupt under-voltage shutdown occurs on TOBY-R2 series modules when the **VCC** supply is removed. If this occurs, it is not possible to store the current parameter settings in the module's non-volatile memory and to perform the proper network detach.

An abrupt shutdown occurs on TOBY-R2 series modules when a low level is applied on the **RESET_N** pin, which is normally set high by an internal pull-up. If this occurs, it is not possible to store the current parameter settings in the module's non-volatile memory and to perform the proper network detach.

An over-temperature or an under-temperature shutdown occurs on TOBY-R2 modules when the temperature measured within the cellular module reaches the dangerous area, if the optional Smart Temperature Supervisor feature is enabled and configured by the dedicated AT command. For more details, see the TOBY-R2 series System Integration Manual [2] and the u-blox AT Commands Manual [1], +USTS AT command.

2.3.3 Module reset

TOBY-R2 series modules can be reset (rebooted) by:

- AT+CFUN command (see the u-blox AT Commands Manual [1]). This causes an “internal” or “software” reset of the module. The current parameter settings are saved in the module’s non-volatile memory and a proper network detach is performed.

An abrupt “external” or “hardware” reset occurs when a low level is applied to the **RESET_N** pin, which is normally set high by an internal pull-up, for a valid time period (see the section 4.2.9). This causes an “external” or “hardware” reset of the entire module, including the integrated power management unit, except for the RTC internal block: the **V_INT** generic digital interfaces supply is switched off and all the digital pins are tri-stated, but the **V_BCKP** supply and the RTC block are enabled. The current parameter settings are not saved in the module’s non-volatile memory and a proper network detach is not performed. The **RESET_N** line should be driven by open drain, open collector or contact switch.

2.3.4 Module / host configuration selection

 Selection of module / host configuration over **HOST_SELECT0** and **HOST_SELECT1** pins is not supported.

TOBY-R2 series modules include two pins (**HOST_SELECT0**, **HOST_SELECT1**) for the selection of the module / host application processor configuration.

2.4 SIM

2.4.1 SIM interface

A SIM card interface is provided on the **VSIM**, **SIM_IO**, **SIM_CLK**, **SIM_RST** pins: the high-speed SIM/ME interface is implemented as well as the automatic detection of the required SIM supporting voltage.

Both 1.8 V and 3 V SIM types are supported (1.8 V and 3 V ME). Activation and deactivation with automatic voltage switch from 1.8 V to 3 V is implemented, according to ISO-IEC 7816-3 specifications. The SIM driver supports the PPS procedure for baud-rate selection, according to the values proposed by the SIM card/chip.

2.4.2 SIM detection

TOBY-R2 series modules provide the SIM detection function over the **GPIO5** pin to sense the SIM card physical presence (as an optional feature) when the pin of the module is properly connected to the mechanical switch of the SIM card holder (for more details, see the TOBY-R2 series System Integration Manual [2]).

2.5 Serial communication

TOBY-R2 series provides the following serial communication interfaces:

- UART interface: Universal Asynchronous Receiver/Transmitter serial interface available for the communication with a host application processor (AT commands, data communication, FW update by means of FOAT), for FW update by means of the u-blox EasyFlash tool and for diagnostic.
- USB interface: Universal Serial Bus 2.0 compliant interface available for the communication with a host application processor (AT commands, data communication, FW update by means of the FOAT feature), for FW update by means of the u-blox EasyFlash tool and for diagnostic.
- DDC interface: I²C bus compatible interface available for the communication with u-blox GNSS positioning chips/modules and with external I²C devices as an audio codec.

- SDIO interface: Secure Digital Input Output interface available for the communication with compatible u-blox short range radio communication Wi-Fi modules.

2.5.1 UART interface

TOBY-R2 series modules include a 9-wire unbalanced Universal Asynchronous Receiver/Transmitter serial interface (UART) for communication with an application host processor (AT commands, data communication, FW update by means of the FOAT feature), for FW update by means of the u-blox EasyFlash tool and for diagnostic.

UART features are:

- Complete serial port with RS-232 functionality conforming to the ITU-T V.24 Recommendation [14], with CMOS compatible signal levels (0 V for low data bit or ON state and 1.8 V for high data bit or OFF state)
- Data lines (**RXD** as output, **TXD** as input), hardware flow control lines (**CTS** as output, **RTS** as input), modem status and control lines (**DTR** as input, **DSR** as output, **DCD** as output, **RI** as output) are provided
- Hardware flow control (default value), software flow control, or none flow control are supported
- Power saving indication available on the hardware flow control output (**CTS** line): the line is driven to the OFF state when the module is not prepared to accept data by the UART interface
- Power saving control over the **RTS** input or the **DTR** input can be enabled via AT+UPSV command (for more details, see the u-blox AT Commands Manual [1] and TOBY-R2 series System Integration Manual [2])
- The following baud rates are supported: 9600, 19200, 38400, 57600, 115200 (default baud rate when autobauding is disabled), 230400, 460800, 921600, 3000000, 3250000, 6000000 and 6500000 bit/s
- One-shot autobauding is supported and it is by default enabled: automatic baud rate detection is performed only once, at module start up. After the detection, the module works at the fixed baud rate (the detected one) and the baud rate can only be changed via AT command (see u-blox AT Commands Manual [1], +IPR).
- The following frame format are supported: 8N2, 8N1 (default format when automatic frame recognition is disabled), 8E1, 8O1, 7E1 and 7O1
- One-shot automatic frame recognition is supported and it is by default enabled in conjunction with automatic baud rate detection (autobauding): the detection is performed only once, at module start up. After the detection, the module works at the detected frame format and it can only be changed via AT command (see u-blox AT Commands Manual [1], +ICF).

UART serial interface can be conveniently configured through AT commands: see the u-blox AT Commands Manual [1] (+IPR, +ICF, +IFC, &K, \Q, +UPSV AT commands) and TOBY-R2 series System Integration Manual [2].

2.5.1.1 Multiplexer protocol

TOBY-R2 series modules include multiplexer functionality as per 3GPP TS 27.010 [10] on the UART physical link.

This is a data link protocol which uses HDLC-like framing and operates between the module (DCE) and the application processor (DTE), allowing a number of simultaneous sessions over the physical link (UART): the user can concurrently use AT interface on one MUX channel and data communication on another MUX channel.

The following virtual channels are available (for details, see the Mux Implementation Application Note [6]):

- Channel 0: Multiplexer control
- Channel 1 – 5: AT commands / data connection
- Channel 6: GNSS data tunneling

 The GNSS data tunneling channel is not supported by TOBY-R200-02B-00 and TOBY-R202-02B-00.

2.5.2 USB interface

TOBY-R2 series modules include a USB High-Speed 2.0 compliant interface with maximum 480 Mbit/s data rate according to the Universal Serial Bus Specification Revision 2.0 [15]. The module itself acts as a USB device and can be connected to any compatible USB host.

The USB interface is available for the communication with a host application processor (AT commands, data communication, FW update by means of the FOAT feature), for FW update by means of the u-blox EasyFlash tool and for diagnostics.

The **USB_D+** / **USB_D-** lines carry the USB data and signaling. The USB interface is automatically enabled by an external valid USB VBUS supply voltage (5.0 V typical) applied on the **VUSB_DET** pin.

The USB interface of TOBY-R2 series modules makes available different USB functions with various capabilities and purposes, such as:

- CDC-ACM for AT commands and data communication
- CDC-ACM for GNSS tunneling
- CDC-ACM for SAP (SIM Access Profile)
- CDC-ACM for Diagnostic log
- CDC-NCM for Ethernet-over-USB

 CDC-ACM for GNSS tunneling is not supported by TOBY-R200-02B-00 and TOBY-R202-02B-00.

 CDC-ACM for SAP, and CDC-NCM for Ethernet-over-USB are not supported by the “02” product versions.

The USB interface provides the following set of USB functions:

- 6 CDC-ACM modem COM ports enumerated as follows:
 - USB1: AT and data
 - USB2: AT and data
 - USB3: AT and data
 - USB4: GNSS tunneling
 - USB5: SAP (SIM Access Profile)
 - USB6: Primary Log (diagnostic purpose)

The user can concurrently use the AT command interface on one CDC, and Packet-Switched / Circuit-Switched Data communication on another CDC.

For more details regarding USB capabilities, see the TOBY-R2 series System Integration Manual [2].

USB drivers are available for the following Windows and Windows Embedded operating system platforms:

- Windows 7
- Windows 8
- Windows 8.1
- Windows 10
- Windows Embedded CE 6.0
- Windows Embedded Compact 7
- Windows Embedded Compact 2013
- Windows 10 IoT

TOBY-R2 series modules are compatible with standard Linux/Android USB kernel drivers.

2.5.3 DDC (I²C) interface

 Communication with u-blox GNSS receivers over DDC (I²C) is not supported by TOBY-R200-02B-00 and TOBY-R202-02B-00 type numbers.

TOBY-R2 series modules include an I²C-bus compatible DDC interface (**SDA**, **SCL**) available to communicate with a u-blox GNSS receiver and with external I²C devices as an audio codec: the TOBY-R2 module acts as an I²C master which can communicate with I²C slaves in accordance with the I²C bus specifications [16].

For more details regarding the DDC (I²C) interface usage and the integration with a u-blox GNSS receiver, see the TOBY-R2 series System Integration Manual [2], the GNSS Implementation Application Note [5], and the I²C and GNSS AT commands description in the u-blox AT Commands Manual [1].

2.5.4 SDIO interface

 The SDIO interface is not supported by “02” modules product versions.

TOBY-R2 series modules include a 4-bit Secure Digital Input Output interface (**SDIO_D0**, **SDIO_D1**, **SDIO_D2**, **SDIO_D3**, **SDIO_CLK**, **SDIO_CMD**) designed to communicate with external compatible u-blox short range radio communication Wi-Fi modules.

2.6 Audio

TOBY-R2 series modules support Voice over LTE (VoLTE) as well as Circuit-Switched Fall-Back (CSFB) from LTE to 3G or 2G radio bearer for providing audio services.

TOBY-R2 series modules include a 4-wire I²S digital audio interface (**I2S_TXD**, **I2S_RXD**, **I2S_CLK**, **I2S_WA**) that can be configured by AT command in PCM mode (short synchronization signal) or in normal I²S mode (long synchronization signal) to transfer digital audio data to/from an external device as an audio codec.

For more details regarding internal audio processing system capabilities, I²S digital audio interface possible configurations, usage and guideline for the integration with an external digital audio device as an audio codec, see the TOBY-R2 series System Integration Manual [2] and the audio sections in the u-blox AT Commands Manual [1].

2.7 Clock output

TOBY-R2 series modules provide a master digital clock output function on the **GPIO6** pin, which can be configured to provide a 13 MHz or 26 MHz square wave. This is mainly designed to feed the master clock input of an external audio codec, as the clock output can be configured in “Audio dependent” mode (generating the square wave only when the audio path is active), or in “Continuous” mode.

For more details, see the u-blox AT Commands Manual [1], +UMCLK AT command.

2.8 GPIO

TOBY-R2 series modules include 9 pins (**GPIO1-GPIO5, I2S_TXD, I2S_RXD, I2S_CLK, I2S_WA**) that can be configured as general purpose input/output or to provide custom functions as summarized in [Table 4](#) (for other details, see the TOBY-R2 series System Integration Manual [\[2\]](#) and GPIO section in u-blox AT Commands Manual [\[1\]](#)).

| Function | Description | Default GPIO | Configurable GPIOs |
|--|---|-----------------------------------|-----------------------------------|
| Network status indication | Network status: registered home network, registered roaming, data transmission, no service | -- | GPIO1-GPIO4 |
| GNSS supply enable ⁹ | Enable/disable the supply of u-blox GNSS receiver connected to the cellular module | GPIO2 | GPIO1-GPIO4 |
| GNSS data ready ⁹ | Sense when u-blox GNSS receiver connected to the module is ready for sending data by the DDC (I ² C) | GPIO3 | GPIO3 |
| GNSS RTC sharing ¹⁰ | RTC synchronization signal to the u-blox GNSS receiver connected to the cellular module | -- | GPIO4 |
| SIM card detection | External SIM card physical presence detection | GPIO5 | GPIO5 |
| SIM card hot insertion/removal | Enable / disable SIM interface upon detection of external SIM card physical insertion / removal | -- | GPIO5 |
| I ² S digital audio interface | I ² S digital audio interface | I2S_RXD, I2S_TXD, I2S_CLK, I2S_WA | I2S_RXD, I2S_TXD, I2S_CLK, I2S_WA |
| Wi-Fi control ¹⁰ | Control of an external Wi-Fi chip or module | -- | -- |
| General purpose input | Input to sense high or low digital level | -- | All |
| General purpose output | Output to set the high or the low digital level | GPIO4 | All |
| Pin disabled | Tri-state with an internal active pull-down enabled | GPIO1 | All |

Table 4: GPIO custom functions configuration

⁹ Not supported by TOBY-R200-02B-00 and TOBY-R202-02B-00. For these type numbers GPIO2 and GPIO3 pins are by default disabled

¹⁰ Not supported by "02" product versions

3 Pin definition

3.1 Pin assignment

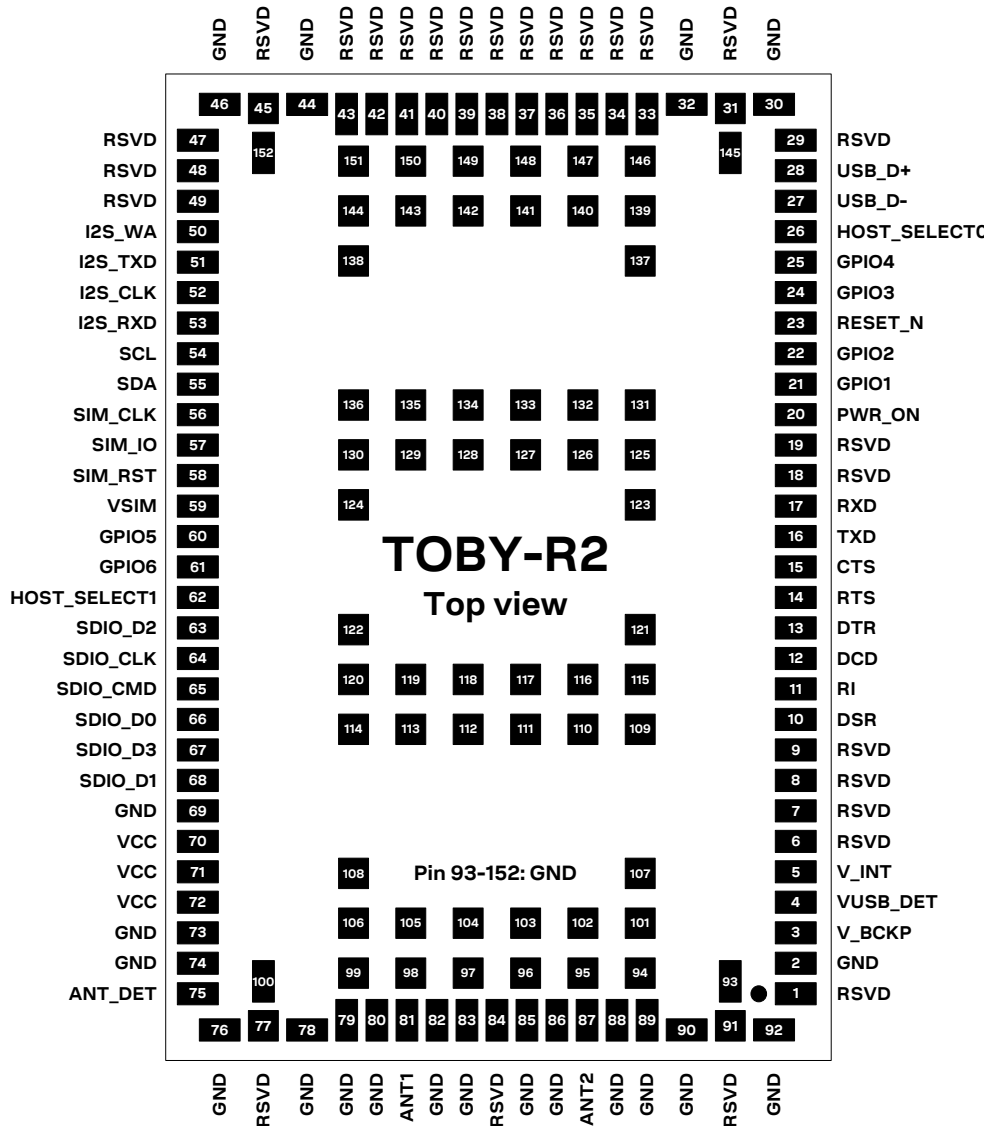

Figure 2: TOBY-R2 series pin assignment (top view)

| No | Name | Power domain | I/O | Description | Remarks |
|----|----------|--------------|-----|--|--|
| 1 | RSVD | - | N/A | RESERVED pin | Leave unconnected. |
| 2 | GND | GND | N/A | Ground | All GND pins must be connected to ground. |
| 3 | V_BCKP | - | I/O | RTC supply Input/Output | 1.8 V (typical) generated by the module when VCC supply voltage is within valid operating range. See section 4.2.2 for detailed electrical specs. |
| 4 | VUSB_DET | VBUS | I | VBUS USB detect input | VBUS (5 V typical) USB supply generated by the host must be connected to this input pin to enable the USB. See section 4.2.11 for detailed electrical specs. |
| 5 | V_INT | GDI | O | Generic Digital Interfaces supply output | 1.8 V (typical) generated by the module when it is switched-on and with the RESET_N is not forced low. See section 4.2.2 for detailed electrical specs. |

| No | Name | Power domain | I/O | Description | Remarks |
|----|---------|--------------|---------|---------------------------------|--|
| 6 | RSVD | - | N/A | RESERVED pin | This pin has special function: it must be connected to GND to allow module to work properly. |
| 7 | RSVD | - | N/A | RESERVED pin | Leave unconnected. |
| 8 | RSVD | - | N/A | RESERVED pin | Leave unconnected. |
| 9 | RSVD | - | N/A | RESERVED pin | Leave unconnected. |
| 10 | DSR | GDI | O / I/O | UART data set ready / GPIO | Circuit 107 (DSR) in ITU-T V.24. Output driver class A. PU/PD class a. Value at internal reset: T/PU. See section 4.2.13 for detailed electrical specs. |
| 11 | RI | GDI | O / I/O | UART ring indicator / GPIO | Circuit 125 (RI) in ITU-T V.24. Output driver class A. PU/PD class a. Value at internal reset: T/PD. See section 4.2.13 for detailed electrical specs. |
| 12 | DCD | GDI | O / I/O | UART data carrier detect / GPIO | Circuit 109 (DCD) in ITU-T V.24. Output driver class A. PU/PD class a. Value at internal reset: T/PD. See section 4.2.13 for detailed electrical specs. |
| 13 | DTR | GDI | I / I/O | UART data terminal ready / GPIO | Circuit 108/2 (DTR) in ITU-T V.24. Internal active pull-up to V_INT enabled. PU/PD class a Value at internal reset: T/PU. See section 4.2.13 for detailed electrical specs. |
| 14 | RTS | GDI | I | UART ready to send | Circuit 105 (RTS) in ITU-T V.24. Internal active pull-up to V_INT. PU/PD class a. Value at internal reset: T/PU. See section 4.2.13 for detailed electrical specs. |
| 15 | CTS | GDI | O | UART clear to send | Circuit 106 (CTS) in ITU-T V.24. Output driver class A. PU/PD class a. Value at internal reset: T/PU. See section 4.2.13 for detailed electrical specs. |
| 16 | TXD | GDI | I | UART data input | Circuit 103 (TxD) in ITU-T V.24. Internal active pull-up to V_INT. PU/PD class a. Value at internal reset: T/PD. See section 4.2.13 for detailed electrical specs. |
| 17 | RXD | GDI | O | UART data output | Circuit 104 (RxD) in ITU-T V.24. Output driver class A. PU/PD class a. Value at internal reset: T/PU. See section 4.2.13 for detailed electrical specs. |
| 18 | RSVD | - | N/A | RESERVED pin | Leave unconnected. Test-Point for diagnostic access is recommended. |
| 19 | RSVD | - | N/A | RESERVED pin | Leave unconnected. Test-Point for diagnostic access is recommended. |
| 20 | PWR_ON | POS | I | Power-on input | Internal 10 kΩ pull-up resistor to V_BCKP. See section 4.2.8 for detailed electrical specs. |
| 21 | GPIO1 | GDI | I/O | GPIO | GPIO configurable as described in section 2.8. Output driver class A. PU/PD class b. Value at internal reset: T/PD. See section 4.2.13 for detailed electrical specs. |
| 22 | GPIO2 | GDI | I/O | GPIO | GPIO configurable as described in section 2.8. Output driver class A. PU/PD class a. Value at internal reset: T/PD. See section 4.2.13 for detailed electrical specs. |
| 23 | RESET_N | ERS | I | External reset input | Internal 10 kΩ pull-up resistor to V_BCKP. See section 4.2.9 for detailed electrical specs. |

| No | Name | Power domain | I/O | Description | Remarks |
|----|--------------|--------------|-----------|--|--|
| 24 | GPIO3 | GDI | I/O | GPIO | GPIO configurable as described in section 2.8. Output driver class A. PU/PD class a. Value at internal reset: T/PD. See section 4.2.13 for detailed electrical specs. |
| 25 | GPIO4 | GDI | I/O | GPIO | GPIO configurable as described in section 2.8. Output driver class A. PU/PD class a. Value at internal reset: T/PD. See section 4.2.13 for detailed electrical specs. |
| 26 | HOST_SELECT0 | GDI | I/O | Selection of module / host processor configuration | Not supported by "O2" product versions. See section 4.2.13 for detailed electrical specs. |
| 27 | USB_D- | USB | I/O | USB Data Line D- | 90 Ω nominal differential characteristic impedance. Pull-up, pull-down and series resistors as required by the USB Revision 2.0 specification [15] are part of the USB pin driver and need not be provided externally. See section 4.2.11 for detailed electrical specs. |
| 28 | USB_D+ | USB | I/O | USB Data Line D+ | 90 Ω nominal differential characteristic impedance. Pull-up, pull-down and series resistors as required by the USB Revision 2.0 specification [15] are part of the USB pin driver and need not be provided externally. See section 4.2.11 for detailed electrical specs. |
| 29 | RSVD | - | N/A | RESERVED pin | Leave unconnected. |
| 30 | GND | GND | N/A | Ground | All GND pins must be connected to ground. |
| 31 | RSVD | - | N/A | RESERVED pin | Leave unconnected. |
| 32 | GND | GND | N/A | Ground | All GND pins must be connected to ground. |
| 33 | RSVD | - | N/A | RESERVED pin | Leave unconnected. |
| 34 | RSVD | - | N/A | RESERVED pin | Leave unconnected. |
| 35 | RSVD | - | N/A | RESERVED pin | Leave unconnected. |
| 36 | RSVD | - | N/A | RESERVED pin | Leave unconnected. |
| 37 | RSVD | - | N/A | RESERVED pin | Leave unconnected. |
| 38 | RSVD | - | N/A | RESERVED pin | Leave unconnected. |
| 39 | RSVD | - | N/A | RESERVED pin | Leave unconnected. |
| 40 | RSVD | - | N/A | RESERVED pin | Leave unconnected. |
| 41 | RSVD | - | N/A | RESERVED pin | Leave unconnected. |
| 42 | RSVD | - | N/A | RESERVED pin | Leave unconnected. |
| 43 | RSVD | - | N/A | RESERVED pin | Leave unconnected. |
| 44 | GND | GND | N/A | Ground | All GND pins must be connected to ground. |
| 45 | RSVD | - | N/A | RESERVED pin | Leave unconnected. |
| 46 | GND | GND | N/A | Ground | All GND pins must be connected to ground. |
| 47 | RSVD | - | N/A | RESERVED pin | Leave unconnected. |
| 48 | RSVD | - | N/A | RESERVED pin | Leave unconnected. |
| 49 | RSVD | - | N/A | RESERVED pin | Leave unconnected. |
| 50 | I2S_WA | GDI | I/O / I/O | I ² S word alignment / GPIO | Configurable as I ² S word alignment, or GPIO (see 2.8) Output driver class A. PU/PD class a. Value at internal reset: T/PD. See section 4.2.13 for detailed electrical specs. |
| 51 | I2S_TXD | GDI | O / I/O | I ² S transmit data / GPIO | Configurable as I ² S data output, or GPIO (see 2.8) Output driver class A. PU/PD class a. Value at internal reset: T/PD. See section 4.2.13 for detailed electrical specs. |

| No | Name | Power domain | I/O | Description | Remarks |
|----|--------------|--------------|--------------|--|--|
| 52 | I2S_CLK | GDI | I/O / I/O | I ² S clock / GPIO | Configurable as I ² S clock , or as GPIO (see section 2.8). Output driver class A. PU/PD class a. Value at internal reset: T/PD. See section 4.2.13 for detailed electrical specs. |
| 53 | I2S_RXD | GDI | I / I/O | I ² S receive data / GPIO | Configurable as I ² S data input, or GPIO (see 2.8) Output driver class A. PU/PD class a. Value at internal reset: T/PD. See section 4.2.13 for detailed electrical specs |
| 54 | SCL | DDC | O | I ² C bus clock line | Fixed open drain. See section 4.2.12 for detailed electrical specs. |
| 55 | SDA | DDC | I/O | I ² C bus data line | Fixed open drain. See section 4.2.12 for detailed electrical specs. |
| 56 | SIM_CLK | SIM | O | SIM clock | See section 4.2.10 for detailed electrical specs. |
| 57 | SIM_IO | SIM | I/O | SIM data | Internal 4.7 kΩ pull-up resistor to VSIM. See section 4.2.10 for detailed electrical specs. |
| 58 | SIM_RST | SIM | O | SIM reset | See section 4.2.10 for detailed electrical specs. |
| 59 | VSIM | - | O | SIM supply output | VSIM = 1.8 V typical or 2.9 V typical generated by the module according to the SIM card/chip voltage type. See section 4.2.2 for detailed electrical specs. |
| 60 | GPIO5 | GDI | I/O | GPIO | Configurable for SIM card detection, or GPIO (see 2.8) Output driver class A. PU/PD class a. Value at internal reset: T/PD. See section 4.2.13 for detailed electrical specs. |
| 61 | GPIO6 | GDI | O | Clock output | Configurable clock output (see section 2.7) Output driver class A. PU/PD class a. Value at internal reset: T/PD. See section 4.2.13 for detailed electrical specs. |
| 62 | HOST_SELECT1 | GDI | I/O | Selection of module / host processor configuration | Not supported by “02” product versions. See section 4.2.13 for detailed electrical specs. |
| 63 | SDIO_D2 | GDI | I/O | SDIO serial data [2] | SDIO not supported by “02” product versions. Output driver class A. PU/PD class a. Value at internal reset: T/PD. See section 4.2.13 for detailed electrical specs. |
| 64 | SDIO_CLK | GDI | O | SDIO serial clock | SDIO not supported by “02” product versions. Output driver class A. PU/PD class a. Value at internal reset: T/PD. See section 4.2.13 for detailed electrical specs. |
| 65 | SDIO_CMD | GDI | I/O | SDIO command | SDIO not supported by “02” product versions. Output driver class A. PU/PD class a. Value at internal reset: T/PD. See section 4.2.13 for detailed electrical specs. |
| 66 | SDIO_D0 | GDI | I/O | SDIO serial data [0] | SDIO not supported by “02” product versions. Output driver class A. PU/PD class a. Value at internal reset: T/PD. See section 4.2.13 for detailed electrical specs. |
| 67 | SDIO_D3 | GDI | I/O | SDIO serial data [3] | SDIO not supported by “02” product versions. Output driver class A. PU/PD class a. Value at internal reset: T/PD. See section 4.2.13 for detailed electrical specs. |
| 68 | SDIO_D1 | GDI | I/O | SDIO serial data [1] | SDIO not supported by “02” product versions. Output driver class A. PU/PD class a. Value at internal reset: T/PD. See section 4.2.13 for detailed electrical specs. |
| 69 | GND | GND | N/A | Ground | All GND pins must be connected to ground. |



| No | Name | Power domain | I/O | Description | Remarks |
|--------|---------|--------------|-----|---------------------|--|
| 70 | VCC | VCC | I | Module supply input | Supply for BB part on TOBY-R200. Supply for BB part and PA on TOBY-R202. All VCC pins must be connected to external supply. See sections 4.2.2 / 4.2.3 for detailed electrical specs. |
| 71 | VCC | VCC | I | Module supply input | Supply for PA on TOBY-R200. Supply for BB part and PA on TOBY-R202. All VCC pins must be connected to external supply. See sections 4.2.2 / 4.2.3 for detailed electrical specs. |
| 72 | VCC | VCC | I | Module supply input | Supply for PA on TOBY-R200. Supply for BB part and PA on TOBY-R202. All VCC pins must be connected to external supply. See sections 4.2.2 / 4.2.3 for detailed electrical specs. |
| 73 | GND | GND | N/A | Ground | All GND pins must be connected to ground. |
| 74 | GND | GND | N/A | Ground | All GND pins must be connected to ground. |
| 75 | ANT_DET | ADC | I | Antenna detection | Antenna presence detection function. See section 4.2.7 for detailed electrical specs. |
| 76 | GND | GND | N/A | Ground | All GND pins must be connected to ground. |
| 77 | RSVD | - | N/A | RESERVED pin | Leave unconnected. |
| 78 | GND | GND | N/A | Ground | All GND pins must be connected to ground. |
| 79 | GND | GND | N/A | Ground | All GND pins must be connected to ground. |
| 80 | GND | GND | N/A | Ground | All GND pins must be connected to ground. |
| 81 | ANT1 | ANT | I/O | Primary antenna | 50 Ω nominal characteristic impedance. Main Tx / Rx antenna interface. See sections 4.2.3 / 4.2.5 / 4.2.6 for details. |
| 82 | GND | GND | N/A | Ground | All GND pins must be connected to ground. |
| 83 | GND | GND | N/A | Ground | All GND pins must be connected to ground. |
| 84 | RSVD | - | N/A | RESERVED pin | Leave unconnected. |
| 85 | GND | GND | N/A | Ground | All GND pins must be connected to ground. |
| 86 | GND | GND | N/A | Ground | All GND pins must be connected to ground. |
| 87 | ANT2 | ANT | I | Secondary antenna | 50 Ω nominal characteristic impedance Rx only for Down-Link Rx diversity. See section 4.2.3 for details. |
| 88 | GND | GND | N/A | Ground | All GND pins must be connected to ground. |
| 89 | GND | GND | N/A | Ground | All GND pins must be connected to ground. |
| 90 | GND | GND | N/A | Ground | All GND pins must be connected to ground. |
| 91 | RSVD | - | N/A | RESERVED pin | Leave unconnected. |
| 92 | GND | GND | N/A | Ground | All GND pins must be connected to ground. |
| 93-152 | GND | GND | N/A | Ground | All GND pins must be connected to ground. |

Table 5: TOBY-R2 series pin-out

 For more information about the pin-out, see the TOBY-R2 series System Integration Manual [2].

 See Appendix A for an explanation of abbreviations and terms used.

4 Electrical specifications

-  Stressing the device above one or more of the ratings listed in the Absolute Maximum Rating section may cause permanent damage. These are stress ratings only. Operating the module at these or at any conditions other than those specified in the Operating Conditions sections (section 4.2) of the specification should be avoided. Exposure to Absolute Maximum Rating conditions for extended periods may affect device reliability.
-  Operating condition ranges define those limits within which the functionality of the device is guaranteed.
-  Where application information is given, it is advisory only and does not form part of the specification.

4.1 Absolute maximum rating

-  Limiting values given below are in accordance with the Absolute Maximum Rating System (IEC 134).

| Symbol | Description | Condition | Min. | Max. | Unit |
|----------|----------------------------|---|-------|------|------|
| VCC | Module supply voltage | Input DC voltage at VCC pin | -0.30 | 5.00 | V |
| V_BCKP | RTC supply voltage | Input DC voltage at V_BCKP pin | -0.15 | 2.00 | V |
| VUSB_DET | USB detection pin | Input DC voltage at VUSB_DET pin | -0.15 | 5.50 | V |
| USB | USB D+/D- pins | Input DC voltage at USB_D+ and USB_D- pins | -1.00 | 5.50 | V |
| GDI | Generic digital interfaces | Input DC voltage at Generic digital interfaces pins | -0.30 | 3.60 | V |
| HSIC | HSIC interface | Input DC voltage at HSIC interface pins | -0.30 | 3.60 | V |
| DDC | DDC interface | Input DC voltage at DDC interface pins | -0.30 | 3.60 | V |
| SIM | SIM interface | Input DC voltage at SIM interface pins | -0.30 | 3.60 | V |
| ERS | External reset signal | Input DC voltage at RESET_N pin | -0.30 | 2.10 | V |
| POS | Power-on input | Input DC voltage at PWR_ON pin | -0.30 | 2.10 | V |
| Tstg | Storage Temperature | | -40 | 85 | °C |

Table 6: Absolute maximum ratings

-  The product is not protected against overvoltage or reversed voltages. If necessary, voltage spikes exceeding the power supply voltage specification, given in table above, must be limited to values within the specified boundaries by using appropriate protection devices.

4.1.1 Maximum ESD

| Parameter | Min | Typ | Max | Unit | Remarks |
|--|-----|-----|------|------|--|
| ESD sensitivity for all pins except ANT1/ANT2 pins | | | 1000 | V | Human Body Model according to JESD22-A114 |
| ESD sensitivity for ANT1/ANT2 pins | | | 1000 | V | Human Body Model according to JESD22-A114 |
| ESD immunity for ANT1/ANT2 pins | | | 4000 | V | Contact Discharge according to IEC 61000-4-2 |
| | | | 8000 | V | Air Discharge according to IEC 61000-4-2 |

Table 7: Maximum ESD ratings

-  u-blox cellular modules are Electrostatic Sensitive Devices and require special precautions when handling. See section 7.4 for ESD handling instructions.

4.2 Operating conditions

Unless otherwise indicated, all operating condition specifications are at an ambient temperature of +25 °C.

Operation beyond the operating conditions is not recommended and extended exposure beyond them may affect device reliability.

4.2.1 Operating temperature range

| Parameter | Min. | Typical | Max. | Unit | Remarks |
|--------------------------------|------|---------|------|------|---|
| Normal operating temperature | -20 | +25 | +65 | °C | Normal operating temperature range (fully functional and meet 3GPP specifications) |
| Extended operating temperature | -40 | | +85 | °C | Extended operating temperature range (RF performance may be affected outside normal operating range, though module is fully functional) |

Table 8: Environmental conditions

4.2.2 Supply/power pins

| Symbol | Parameter | Min. | Typical | Max. | Unit |
|--------|---|------|---------|------|------|
| VCC | Module supply normal operating input voltage ¹¹ | 3.30 | 3.80 | 4.40 | V |
| | Module supply extended operating input voltage ¹² | 3.00 | 3.80 | 4.50 | V |
| | Module supply extended operating input voltage ¹³ | 2.80 | 3.80 | 4.50 | V |
| V_BCKP | Real Time Clock supply input voltage | 1.00 | 1.80 | 1.90 | V |
| I_BCKP | Real Time Clock supply average current consumption, at V_BCKP = 1.8 V | | 2.00 | | µA |

Table 9: Input characteristics of the Supply/Power pins

| Symbol | Parameter | Min. | Typical | Max. | Unit |
|--------------|---|------|---------|------|------|
| VSIM | SIM supply output voltage | | 1.80 | | V |
| | | | 2.90 | | V |
| V_BCKP | Real Time Clock supply output voltage | | 1.80 | | V |
| I_BCKP | Real Time Clock supply output current capability | | | 3 | mA |
| V_INT | Generic Digital Interfaces supply output voltage | | 1.80 | | V |
| V_INT_RIPPLE | Generic Digital Interfaces supply output voltage ripple with power saving disabled (AT+UPSV=0) | | | 15 | mVpp |
| | Generic Digital Interfaces supply output voltage ripple with power saving enabled (AT+UPSV=1/2/3) | | | 35 | mVpp |
| I_INT | Generic Digital Interfaces supply output current capability | | | 70 | mA |

Table 10: Output characteristics of the Supply/Power pins

¹¹ RF performance may be affected when the input voltage at **VCC** is outside the herein stated normal operating range limits, though module is still fully functional when the input voltage at **VCC** is inside the extended operating range limits.

¹² Range defined for all the **VCC** pins of TOBY-R202 modules, and the **VCC** pin #70 (supply input for internal baseband Power Management Unit and the internal transceiver) of TOBY-R200 modules. Input voltage at the related **VCC** pins must be above the herein stated extended operating range minimum limit to switch-on the TOBY-R2 series modules. The TOBY-R2 series modules may switch-off when the input voltage at the related **VCC** pins drops below the herein stated extended operating range minimum limit.

¹³ Range defined for the **VCC** pins #71 and #72 (supply input for the internal power amplifier) of TOBY-R200 modules.

4.2.3 Current consumption

| Mode | Condition | Tx power | Min | Typ ¹⁴ | Max ¹⁵ | Unit |
|--|---|----------|-----|-------------------|-------------------|------|
| Idle-Mode (Power Saving enabled by AT+UPSV, module in low power idle-mode, equivalent to airplane mode) | Averaged current value over a 100-ms period, USB not connected | | | 0.9 | | mA |
| | Averaged current value over a 100-ms period, USB connected and suspended | | | 1.1 | | mA |
| Cyclic Idle/Active-Mode (Power Saving enabled by AT+UPSV, Module registered with network) | Averaged current value over a 10-minute period, USB not connected | | | 1.4 | | mA |
| | Averaged current value over a 10-minute period, USB connected and suspended | | | 1.6 | | mA |
| Active-Mode (Power Saving disabled by AT+UPSV, Module registered with network) | Averaged current value over a 10-minute period, USB not connected | | | 11.1 | | mA |
| | Averaged current value over a 10-minute period, USB connected and not suspended | | | 29.5 | | mA |
| 2G Connected Mode (Tx / Rx call enabled) | Pulse current during a 1-slot GMSK Tx burst, 850/900 MHz bands | Maximum | | 1.5 | 1.9 | A |
| | | Minimum | | 50 | | mA |
| | Averaged current value over a 10-second period, 2G GMSK call, 1 Tx + 1 Rx slot, 850/900 MHz | Maximum | | 220 | | mA |
| | | Minimum | | 50 | | mA |
| | Averaged current value over a 10-second period, 2G GMSK call, 1 Tx + 1 Rx slot, 1800/1900 MHz | Maximum | | 180 | | mA |
| | | Minimum | | 120 | | mA |
| 3G Connected Mode (Tx / Rx call enabled) | Averaged current value over a 10-second period | 0 dBm | | 130 | | mA |
| | | 12 dBm | | 175 | | mA |
| | | 18 dBm | | 270 | | mA |
| | | Maximum | | 490 | | mA |
| | | Minimum | | 185 | | mA |
| LTE Connected Mode (Tx / Rx call enabled) | Averaged current value over a 10-second period | 0 dBm | | 200 | | mA |
| | | 12 dBm | | 245 | | mA |
| | | 18 dBm | | 365 | | mA |
| | | Maximum | | 540 | | mA |

Table 11: TOBY-R2 series modules VCC current consumption

| Parameter | Min | Typ | Max | Unit |
|--|-----|-----|-----|------|
| Current consumption through the VCC pin #70 of TOBY-R200 modules (supply input for internal baseband Power Management Unit and the internal transceiver) | | | 300 | mA |

Table 12: TOBY-R200 modules VCC pin #70 current consumption

¹⁴ Typical values with a matched antenna

¹⁵ Maximum values with a mismatched antenna

4.2.4 LTE RF characteristics

The LTE bands supported by each TOBY-R2 series module are defined in [Table 2](#), while the following [Table 13](#) describes the Transmitting and Receiving frequencies for each LTE band according to 3GPP TS 36.521-1 [11].

| Parameter | | Min. | Max. | Unit | Remarks |
|--|----------|------|------|------|-----------------|
| Frequency range Band 12 (700 MHz) ¹⁶ | Uplink | 699 | 716 | MHz | Module transmit |
| | Downlink | 729 | 746 | MHz | Module receive |
| Frequency range Band 5 (850 MHz) | Uplink | 824 | 849 | MHz | Module transmit |
| | Downlink | 869 | 894 | MHz | Module receive |
| Frequency range Band 4 (1700 MHz) | Uplink | 1710 | 1755 | MHz | Module transmit |
| | Downlink | 2110 | 2155 | MHz | Module receive |
| Frequency range Band 2 (1900 MHz) | Uplink | 1850 | 1910 | MHz | Module transmit |
| | Downlink | 1930 | 1990 | MHz | Module receive |

Table 13: LTE operating RF frequency bands

TOBY-R2 series modules include a UE Power Class 3 LTE transmitter (see [Table 2](#)), with output power and characteristics according to 3GPP TS 36.521-1 [11].

TOBY-R2 series modules LTE receiver characteristics are compliant to 3GPP TS 36.521-1 [11], with LTE conducted receiver sensitivity performance described in [Table 14](#).

| Parameter | Min. | Typical | Max. | Unit | Remarks |
|---|--------|---------|------|------|-----------------------------|
| Receiver input sensitivity Band 12 (700 MHz) | -110.5 | | | dBm | Channel bandwidth = 1.4 MHz |
| | -107.5 | | | dBm | Channel bandwidth = 3 MHz |
| | -105.0 | | | dBm | Channel bandwidth = 5 MHz |
| | -102.5 | | | dBm | Channel bandwidth = 10 MHz |
| Receiver input sensitivity Band 5 (850 MHz) | -110.0 | | | dBm | Channel bandwidth = 1.4 MHz |
| | -107.5 | | | dBm | Channel bandwidth = 3 MHz |
| | -105.0 | | | dBm | Channel bandwidth = 5 MHz |
| | -102.5 | | | dBm | Channel bandwidth = 10 MHz |
| Receiver input sensitivity Band 4 (1700 MHz) | -110.0 | | | dBm | Channel bandwidth = 1.4 MHz |
| | -107.0 | | | dBm | Channel bandwidth = 3 MHz |
| | -104.5 | | | dBm | Channel bandwidth = 5 MHz |
| | -102.0 | | | dBm | Channel bandwidth = 10 MHz |
| | -100.0 | | | dBm | Channel bandwidth = 15 MHz |
| | -99.0 | | | dBm | Channel bandwidth = 20 MHz |
| Receiver input sensitivity Band 2 (1900 MHz) | -109.5 | | | dBm | Channel bandwidth = 1.4 MHz |
| | -107.0 | | | dBm | Channel bandwidth = 3 MHz |
| | -104.5 | | | dBm | Channel bandwidth = 5 MHz |
| | -102.0 | | | dBm | Channel bandwidth = 10 MHz |
| | -100.0 | | | dBm | Channel bandwidth = 15 MHz |
| | -99.0 | | | dBm | Channel bandwidth = 20 MHz |

Condition: 50 Ω source, Throughput > 95%, dual receiver, QPSK modulation, other settings as per 3GPP TS 36.521-1 [11]

Table 14: LTE receiver sensitivity performance

¹⁶ LTE band 12 is a superset that includes band 17: the LTE band 12 is supported along with Multi-Frequency Band Indicator (MFBI) feature

4.2.5 3G RF characteristics

The 3G bands supported by each TOBY-R2 series module are defined in [Table 2](#), while the following [Table 15](#) describes the Transmitting and Receiving frequencies for each 3G band according to 3GPP TS 34.121-1 [12].

| Parameter | | Min. | Max. | Unit | Remarks |
|--------------------------------------|----------|------|------|------|-----------------|
| Frequency range Band 5 (850 MHz) | Uplink | 824 | 849 | MHz | Module transmit |
| | Downlink | 869 | 894 | MHz | Module receive |
| Frequency range Band 8 (900 MHz) | Uplink | 880 | 915 | MHz | Module transmit |
| | Downlink | 925 | 960 | MHz | Module receive |
| Frequency range Band 2 (1900 MHz) | Uplink | 1850 | 1910 | MHz | Module transmit |
| | Downlink | 1930 | 1990 | MHz | Module receive |
| Frequency range Band 1 (2100 MHz) | Uplink | 1920 | 1980 | MHz | Module transmit |
| | Downlink | 2110 | 2170 | MHz | Module receive |

Table 15: 3G operating RF frequency bands

TOBY-R2 series modules include a UE Power Class 3 3G transmitter (see [Table 2](#)), with output power and characteristics according to 3GPP TS 34.121-1 [12].

TOBY-R2 series modules 3G receiver characteristics are compliant to 3GPP TS 34.121-1 [12], with 3G conducted receiver sensitivity performance described in [Table 16](#).

| Parameter | Min. | Typical | Max. | Unit | Remarks |
|---|--------|---------|------|------|---|
| Receiver input sensitivity Band 5 (850 MHz) | -115.0 | | | dBm | Downlink RF level for RMC @ BER < 0.1 % |
| Receiver input sensitivity Band 8 (900 MHz) | -115.0 | | | dBm | Downlink RF level for RMC @ BER < 0.1 % |
| Receiver input sensitivity Band 2 (1900 MHz) | -114.0 | | | dBm | Downlink RF level for RMC @ BER < 0.1 % |
| Receiver input sensitivity Band 1 (2100 MHz) | -114.0 | | | dBm | Downlink RF level for RMC @ BER < 0.1 % |

Condition: 50 Ω source, dual receiver, other settings as per 3GPP TS 34.121-1 [12]

Table 16: 3G receiver sensitivity performance

4.2.6 2G RF characteristics

The 2G bands supported by each TOBY-R2 series module are defined in [Table 2](#), while [Table 17](#) describes the Transmitting and Receiving frequencies for each 2G band according to 3GPP TS 51.010-1 [13].

| Parameter | | Min. | Max. | Unit | Remarks |
|------------------------------|----------|------|------|------|-----------------|
| Frequency range GSM 850 | Uplink | 824 | 849 | MHz | Module transmit |
| | Downlink | 869 | 894 | MHz | Module receive |
| Frequency range E-GSM 900 | Uplink | 880 | 915 | MHz | Module transmit |
| | Downlink | 925 | 960 | MHz | Module receive |
| Frequency range DCS 1800 | Uplink | 1710 | 1785 | MHz | Module transmit |
| | Downlink | 1805 | 1880 | MHz | Module receive |
| Frequency range PCS 1900 | Uplink | 1850 | 1910 | MHz | Module transmit |
| | Downlink | 1930 | 1990 | MHz | Module receive |

Table 17: 2G operating RF frequency bands

TOBY-R2 series modules include a GMSK Power Class 4 transmitter for GSM 850 and E-GSM 900 bands, a GMSK Power Class 1 transmitter for DCS 1800 and PCS 1900 bands, a 8-PSK Power Class E2

transmitter for all 2G bands (see [Table 2](#)), with output power and characteristics according to 3GPP TS 51.010-1 [\[13\]](#).

TOBY-R2 series modules 2G receiver characteristics are compliant to 3GPP TS 51.010-1 [\[13\]](#), with conducted receiver sensitivity performance described in [Table 18](#).

| Parameter | Min. | Typical | Max. | Unit | Remarks |
|---|------|---------|------|------|--|
| Receiver input sensitivity GSM 850 | | -110.0 | | dBm | Downlink RF level @ BER Class II < 2.4 % |
| Receiver input sensitivity E-GSM 900 | | -110.0 | | dBm | Downlink RF level @ BER Class II < 2.4 % |
| Receiver input sensitivity DCS 1800 | | -109.0 | | dBm | Downlink RF level @ BER Class II < 2.4 % |
| Receiver input sensitivity PCS 1900 | | -109.0 | | dBm | Downlink RF level @ BER Class II < 2.4 % |

Condition: 50 Ω source, other settings as per 3GPP TS 51.010-1 [\[13\]](#)

Table 18: 2G receiver sensitivity performance

4.2.7 ANT_DET pin

| Pin name | Parameter | Min. | Typical | Max. | Unit | Remarks |
|----------|--|------|---------|------|---------|---|
| ANT_DET | Output DC current pulse value | | 9 | | μ A | Generated by means of the AT+UANTR command |
| | Output DC current pulse time length | | 330 | | μ s | Generated by means of the AT+UANTR command |

Table 19: ANT_DET pin characteristics

4.2.8 PWR_ON pin

| Pin name | Parameter | Min. | Typical | Max. | Unit | Remarks |
|----------|--|-------|---------|------|------------|---|
| PWR_ON | Internal supply for Power-On Input Signal | | 1.80 | | V | RTC supply (V_BCKP) |
| | Low-level input | -0.30 | | 0.54 | V | |
| | High-level input | 1.26 | | 2.10 | V | |
| | Pull-up resistance | | 10 | | k Ω | Internal active pull-up to V_BCKP |
| | Low-level input current | | -180 | | μ A | |
| | Low pulse time | 50 | | | μ s | Low pulse time to switch-on the module |
| | Low pulse time | 1 | | | s | Low pulse time to switch-off the module |

Table 20: PWR_ON pin characteristics

4.2.9 RESET_N pin

| Pin name | Parameter | Min. | Typical | Max. | Unit | Remarks |
|----------|--|-------|---------|------|------------|------------------------------------|
| RESET_N | Internal supply for External Reset Input Signal | | 1.80 | | V | RTC supply (V_BCKP) |
| | Low-level input | -0.30 | | 0.54 | V | |
| | High-level input | 1.26 | | 2.10 | V | |
| | Pull-up resistance | | 10 | | k Ω | Internal active pull-up to V_BCKP |
| | Low-level input current | | -180 | | μ A | |
| | Low pulse time | 50 | | | ms | Low pulse time to reset the module |

Table 21: RESET_N pin characteristics

4.2.10 SIM pins

The SIM pins are a dedicated interface to the external SIM card/chip. The electrical characteristics fulfill regulatory specification requirements. The values in [Table 22](#) are for information only.

| Parameter | Min. | Typical | Max. | Unit | Remarks |
|-------------------------------------|------|---------|------|------|---|
| Low-level input | 0.00 | | 0.35 | V | VSIM = 1.80 V |
| | 0.00 | | 0.57 | V | VSIM = 2.90 V |
| High-level input | 1.29 | | 3.30 | V | VSIM = 1.80 V |
| | 2.07 | | 3.30 | V | VSIM = 2.90 V |
| Low-level output | | 0.00 | 0.35 | V | VSIM = 1.80 V, Max value at I _{OL} = +1.0 mA |
| | | 0.00 | 0.35 | V | VSIM = 2.90 V, Max value at I _{OL} = +1.0 mA |
| High-level output | 1.26 | 1.80 | | V | VSIM = 1.80 V, Min value at I _{OH} = -1.0 mA |
| | 2.03 | 2.90 | | V | VSIM = 2.90 V, Min value at I _{OH} = -1.0 mA |
| Input / Output leakage current | | | 0.7 | μA | 0.2V < V _{IN} < 3.3V |
| Clock frequency on SIM_CLK | | 3.25 | | MHz | |
| Internal pull-up resistor on SIM_IO | | 4.7 | | kΩ | Internal pull-up to VSIM supply |

Table 22: SIM pins characteristics

4.2.11 USB pins

USB data lines (**USB_D+** / **USB_D-**) are compliant to the USB 2.0 high-speed specification. See the Universal Serial Bus Specification Revision 2.0 [\[15\]](#) for detailed electrical characteristics. The values in [Table 23](#) related to USB 2.0 high-speed physical layer specifications are for information only.

| Parameter | Min. | Typ. | Max. | Unit | Remarks |
|---|-------|------|------|------|---------|
| VUSB_DET pin, High-level input | 1.50 | 5.00 | 5.25 | V | |
| VUSB_DET pin, Low-level input | -0.15 | 0.00 | 0.40 | V | |
| VUSB_DET pin, input current sink | | 25 | | μA | |
| High-speed squelch detection threshold (input differential signal amplitude) | 100 | | 150 | mV | |
| High speed disconnect detection threshold (input differential signal amplitude) | 525 | | 625 | mV | |
| High-speed data signaling input common mode voltage range | -50 | | 500 | mV | |
| High-speed idle output level | -10 | | 10 | mV | |
| High-speed data signaling output high level | 360 | | 440 | mV | |
| High-speed data signaling output low level | -10 | | 10 | mV | |
| Chirp J level (output differential voltage) | 700 | | 1100 | mV | |
| Chirp K level (output differential voltage) | -900 | | -500 | mV | |

Table 23: USB pins characteristics

4.2.12 DDC (I²C) pins

DDC (I²C) lines (**SCL** and **SDA**) are compliant to the I²C-bus standard mode specification. See the I²C-Bus Specification [\[16\]](#) for detailed electrical characteristics. The values in [Table 24](#) related to the I²C-bus standard mode specifications are for information only.

| Parameter | Min | Typical | Max | Unit | Remarks |
|--------------------------------|-------|---------|------|------|--|
| Internal supply for GDI domain | | 1.80 | | V | Digital I/O Interfaces supply (V_INT) |
| Low-level input | -0.20 | | 0.36 | V | |
| High-level input | 1.26 | | 2.00 | V | |
| Low-level output | | 0.00 | 0.35 | V | Max value at I _{OL} = +1.0 mA |
| Clock frequency on SCL | | 100 | | kHz | |

Table 24: DDC (I²C) pins characteristics

4.2.13 Generic Digital Interfaces pins

| Parameter | Min | Typical | Max | Unit | Remarks |
|----------------------------------|-------|---------|------|------|---|
| Internal supply for GDI domain | | 1.80 | | V | Digital I/O Interfaces supply (V_INT) |
| Low-level input | -0.20 | | 0.36 | V | |
| High-level input | 1.26 | | 2.00 | V | |
| Low-level output | | 0.00 | 0.35 | V | Max value at I _{OL} = +6.0 mA for driver class A |
| High-level output | 1.45 | 1.80 | | V | Min value at I _{OH} = -6.0 mA for driver class A |
| Internal pull-up input current | | | -240 | μA | PU class a |
| | | | -110 | μA | PU class b |
| Internal pull-down input current | | | 240 | μA | PD class a |
| | | | 100 | μA | PD class b |
| Input/output leakage current | | | 0.7 | μA | 0.2V < V _{IN} < 2.0V |

Table 25: GDI pin characteristics

4.2.13.1 AC characteristics of clock output pin

| Parameter | Description | Min | Typical | Max | Unit | Remarks |
|-----------|------------------------------|-----|---------|-----|------|------------|
| 1/T1 | GPIO6 clock output frequency | | 13 | | MHz | AT+UMCLK=2 |
| | | | 26 | | MHz | AT+UMCLK=3 |

Table 26: AC characteristics of the GPIO6 clock output pin

4.2.13.2 AC characteristics of I2S pins

| Parameter | Description | Min | Typical | Max | Unit | Remarks |
|-----------|--|-----|---------|---------------------|------|-----------------------|
| 1/T1 | I2S_WA frequency | | 8.000 | | kHz | <I2S_sample_rate>=0 |
| | | | 11.025 | | kHz | <I2S_sample_rate>=1 |
| | | | 12.000 | | kHz | <I2S_sample_rate>=2 |
| | | | 16.000 | | kHz | <I2S_sample_rate>=3 |
| | | | 22.050 | | kHz | <I2S_sample_rate>=4 |
| | | | 24.000 | | kHz | <I2S_sample_rate>=5 |
| | | | 32.000 | | kHz | <I2S_sample_rate>=6 |
| | | | 44.100 | | kHz | <I2S_sample_rate>=7 |
| | 48.000 | | kHz | <I2S_sample_rate>=8 | | |
| 1/T2 | I2S_CLK frequency | | 32 | | 1/T1 | <I2S_mode> = 2,...,13 |
| T3 | I2S_TXD invalid before I2S_CLK edge | | | 24 | ns | <I2S_mode> = 2,...,13 |
| T4 | I2S_TXD valid after I2S_CLK edge | | | 32 | ns | <I2S_mode> = 2,...,13 |
| T5 | I2S_RXD setup time before I2S_CLK edge | 60 | | | ns | <I2S_mode> = 2,...,13 |
| T6 | I2S_RXD hold time after I2S_CLK edge | 10 | | | ns | <I2S_mode> = 2,...,13 |

Table 27: AC characteristics of digital audio interface (I2S) pins in Normal I²S mode (long synchronization signal), Master role

| Parameter | Description | Min | Typical | Max | Unit | Remarks |
|-----------|-------------------------------------|--------|---------|---------------------|------|-----------------------|
| 1/T1 | I2S_WA frequency | | | 8.000 | kHz | <I2S_sample_rate>=0 |
| | | | | 11.025 | kHz | <I2S_sample_rate>=1 |
| | | | | 12.000 | kHz | <I2S_sample_rate>=2 |
| | | | | 16.000 | kHz | <I2S_sample_rate>=3 |
| | | | | 22.050 | kHz | <I2S_sample_rate>=4 |
| | | | | 24.000 | kHz | <I2S_sample_rate>=5 |
| | | | | 32.000 | kHz | <I2S_sample_rate>=6 |
| | | | | 44.100 | kHz | <I2S_sample_rate>=7 |
| | | 48.000 | kHz | <I2S_sample_rate>=8 | | |
| 1/T2 | I2S_CLK frequency | | | 32 | 1/T1 | <I2S_mode> = 2,...,13 |
| T3 | I2S_TXD invalid before I2S_CLK edge | | | 12 | ns | <I2S_mode> = 2,...,13 |

| Parameter | Description | Min | Typical | Max | Unit | Remarks |
|-----------|--|-----|---------|-----|------|-----------------------|
| T4 | I2S_TXD valid after I2S_CLK edge | | | 79 | ns | <I2S_mode> = 2,...,13 |
| T5 | I2S_RXD setup time before I2S_CLK edge | 22 | | | ns | <I2S_mode> = 2,...,13 |
| T6 | I2S_RXD hold time after I2S_CLK edge | 24 | | | ns | <I2S_mode> = 2,...,13 |

Table 28: AC characteristics of digital audio interface (I²S) pins in Normal I²S mode (long synchronization signal), Slave role

| Parameter | Description | Min | Typical | Max | Unit | Remarks |
|-----------|--|-----|---------|-----|------|---------------------|
| 1/T1 | I2S_WA frequency | | 8.000 | | kHz | <I2S_sample_rate>=0 |
| | | | 11.025 | | kHz | <I2S_sample_rate>=1 |
| | | | 12.000 | | kHz | <I2S_sample_rate>=2 |
| | | | 16.000 | | kHz | <I2S_sample_rate>=3 |
| | | | 22.050 | | kHz | <I2S_sample_rate>=4 |
| | | | 24.000 | | kHz | <I2S_sample_rate>=5 |
| | | | 32.000 | | kHz | <I2S_sample_rate>=6 |
| | | | 44.100 | | kHz | <I2S_sample_rate>=7 |
| 1/T2 | I2S_CLK frequency | | 18 | | 1/T1 | <I2S_mode> = 0 |
| | | | 17 | | 1/T1 | <I2S_mode> = 1 |
| T3 | I2S_WA high begin after I2S_CLK high begin | -24 | | 32 | ns | <I2S_mode> = 0, 1 |
| T4 | I2S_WA high end after I2S_CLK low end | -24 | | 32 | ns | <I2S_mode> = 0, 1 |
| T5 | I2S_TXD invalid before I2S_CLK low end | | | 24 | ns | <I2S_mode> = 0, 1 |
| T6 | I2S_TXD valid after I2S_CLK high begin | | | 22 | ns | <I2S_mode> = 0, 1 |
| T7 | I2S_RXD setup time before I2S_CLK high end | 60 | | | ns | <I2S_mode> = 0, 1 |
| T8 | I2S_RXD hold time after I2S_CLK low begin | 12 | | | ns | <I2S_mode> = 0, 1 |

Table 29: AC characteristics of digital audio interface (I²S) pins in PCM mode (short synchronization signal), Master role

| Parameter | Description | Min | Typical | Max | Unit | Remarks |
|-----------|--|-----|---------|--------|------|---------------------|
| 1/T1 | I2S_WA frequency | | | 8.000 | kHz | <I2S_sample_rate>=0 |
| | | | | 11.025 | kHz | <I2S_sample_rate>=1 |
| | | | | 12.000 | kHz | <I2S_sample_rate>=2 |
| | | | | 16.000 | kHz | <I2S_sample_rate>=3 |
| | | | | 22.050 | kHz | <I2S_sample_rate>=4 |
| | | | | 24.000 | kHz | <I2S_sample_rate>=5 |
| | | | | 32.000 | kHz | <I2S_sample_rate>=6 |
| | | | | 44.100 | kHz | <I2S_sample_rate>=7 |
| 1/T2 | I2S_CLK frequency | | | 18 | 1/T1 | <I2S_mode> = 0 |
| | | | | 17 | 1/T1 | <I2S_mode> = 1 |
| T3 | I2S_WA high begin before I2S_CLK low begin | 36 | | | ns | <I2S_mode> = 0, 1 |
| T4 | I2S_WA low begin before I2S_CLK low begin | 36 | | | ns | <I2S_mode> = 0, 1 |
| T5 | I2S_TXD invalid before I2S_CLK rising edge | | | 12 | ns | <I2S_mode> = 0, 1 |
| T6 | I2S_TXD valid after I2S_CLK rising edge | | | 79 | ns | <I2S_mode> = 0, 1 |
| T7 | I2S_RXD setup time before I2S_CLK falling edge | 22 | | | ns | <I2S_mode> = 0, 1 |
| T8 | I2S_RXD hold time after I2S_CLK falling edge | 24 | | | ns | <I2S_mode> = 0, 1 |

Table 30: AC characteristics of digital audio interface (I²S) pins in PCM mode (short synchronization signal), Slave role

5 Mechanical specifications

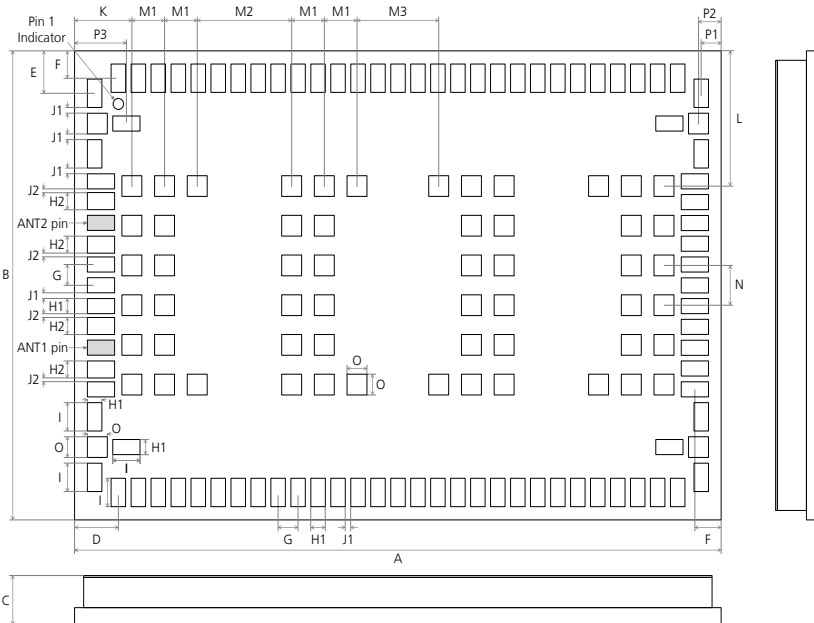

Figure 3: TOBY-R2 series dimensions (bottom and side views)

| Parameter | Description | Typical | | Tolerance | |
|-----------|--|---------|--------------|-------------|------------------|
| A | Module Height [mm] | 35.6 | (1401.6 mil) | +0.20/-0.20 | (+7.9/-7.9 mil) |
| B | Module Width [mm] | 24.8 | (976.4 mil) | +0.20/-0.20 | (+7.9/-7.9 mil) |
| C | Module Thickness [mm] | 2.6 | (102.4 mil) | +0.27/-0.17 | (+10.6/-6.7 mil) |
| D | Horizontal Edge to Lateral Pin Pitch [mm] | 2.4 | (94.5 mil) | +0.20/-0.20 | (+7.9/-7.9 mil) |
| E | Vertical Edge to Lateral Pin Pitch [mm] | 2.25 | (88.6 mil) | +0.20/-0.20 | (+7.9/-7.9 mil) |
| F | Edge to Lateral Pin Pitch [mm] | 1.45 | (57.1 mil) | +0.20/-0.20 | (+7.9/-7.9 mil) |
| G | Lateral Pin to Pin Pitch [mm] | 1.1 | (43.3 mil) | +0.02/-0.02 | (+0.8/-0.8 mil) |
| H1 | Lateral Pin Height [mm] | 0.8 | (31.5 mil) | +0.02/-0.02 | (+0.8/-0.8 mil) |
| H2 | Lateral Pin close to ANT1 and ANT2 Height [mm] | 0.9 | (35.4 mil) | +0.02/-0.02 | (+0.8/-0.8 mil) |
| I | Lateral Pin Width [mm] | 1.5 | (59.1 mil) | +0.02/-0.02 | (+0.8/-0.8 mil) |
| J1 | Lateral Pin to Pin Distance [mm] | 0.3 | (11.8 mil) | +0.02/-0.02 | (+0.8/-0.8 mil) |
| J2 | Lateral Pin to Pin close to ANT Distance [mm] | 0.2 | (7.9 mil) | +0.02/-0.02 | (+0.8/-0.8 mil) |
| K | Horizontal Edge to Central Pin Pitch [mm] | 3.15 | (124.0 mil) | +0.20/-0.20 | (+7.9/-7.9 mil) |
| L | Vertical Edge to Central Pin Pitch [mm] | 7.15 | (281.5 mil) | +0.20/-0.20 | (+7.9/-7.9 mil) |
| M1 | Central Pin to Pin Horizontal Pitch [mm] | 1.8 | (70.9 mil) | +0.02/-0.02 | (+0.8/-0.8 mil) |
| M2 | Central Pin to Pin Horizontal Pitch [mm] | 5.2 | (204.7 mil) | +0.02/-0.02 | (+0.8/-0.8 mil) |
| M3 | Central Pin to Pin Horizontal Pitch [mm] | 4.5 | (177.2 mil) | +0.02/-0.02 | (+0.8/-0.8 mil) |
| N | Central Pin to Pin Vertical Pitch [mm] | 2.1 | (82.7 mil) | +0.02/-0.02 | (+0.8/-0.8 mil) |
| O | Central Pin Height and Width [mm] | 1.1 | (43.3 mil) | +0.02/-0.02 | (+0.8/-0.8 mil) |
| P1 | Horizontal Edge to Corner Pin Pitch [mm] | 1.1 | (43.3 mil) | +0.20/-0.20 | (+7.9/-7.9 mil) |
| P2 | Horizontal Edge to Corner Pin Pitch [mm] | 1.25 | (49.2 mil) | +0.20/-0.20 | (+7.9/-7.9 mil) |
| P3 | Horizontal Edge to Corner Pin Pitch [mm] | 2.85 | (112.2 mil) | +0.20/-0.20 | (+7.9/-7.9 mil) |
| Weight | Module Weight [g] | 4.8 | | | |

Table 31: TOBY-R2 series dimensions

- Module Height tolerance +/-0.20 mm may be exceeded close to the corners of the PCB due to cutting process: in worst case the Height could be +0.40 mm longer than the typical value.
- For information regarding Footprint and Paste Mask recommended for the application board integrating the cellular module, see TOBY-R2 series System Integration Manual [2].

6 Qualification and approvals

6.1 Reliability tests

Tests for product family qualifications according to ISO 16750 "Road vehicles - Environmental conditions and testing for electrical and electronic equipment", and appropriate standards.

6.2 Approvals



Products marked with this lead-free symbol on the product label comply with the "Directive 2002/95/EC of the European Parliament and the Council on the Restriction of Use of certain Hazardous Substances in Electrical and Electronic Equipment" (RoHS).

TOBY-R2 series modules are RoHS compliant.

No natural rubbers, hygroscopic materials, or materials containing asbestos are employed.

Table 32 summarizes the main approvals for TOBY-R2 series modules.

| Certification Scheme | TOBY-R200 | TOBY-R202 |
|--|----------------|----------------|
| PTCRB (PCS Type Certification Review Board) | • | • |
| CE (Conformité Européenne) | • | |
| FCC (United States Federal Communications Commission) | • | • |
| FCC identification number | XPY1EHM44NN | XPY1EHQ24NN |
| ISED (Innovation, Science and Economic Development Canada) ¹⁷ | • | • |
| IC certification number | 8595A-1EHM44NN | 8595A-1EHQ24NN |
| T-Mobile (US network operator) | | • |
| AT&T (US network operator) | • | • |
| U.S. Cellular (US network operator) | | • |

Table 32: TOBY-R2 series main certification approvals summary

For the complete list of approvals and for specific details on all country and network operators' certifications, see our website www.u-blox.com or contact the u-blox office or sales representative nearest you.

¹⁷ Formerly known as IC (Industry Canada)

7 Product handling & soldering

7.1 Packaging

TOBY-R2 series modules are delivered as hermetically sealed, reeled tapes to enable efficient production, production lot set-up and tear-down. For more information about packaging, see the u-blox Package Information User Guide [7].

7.1.1 Reels

TOBY-R2 series modules are deliverable in quantities of 150 pieces on a reel. The modules are delivered using the reel type B3 described in the Figure 4 and in the u-blox Package Information Guide [7].

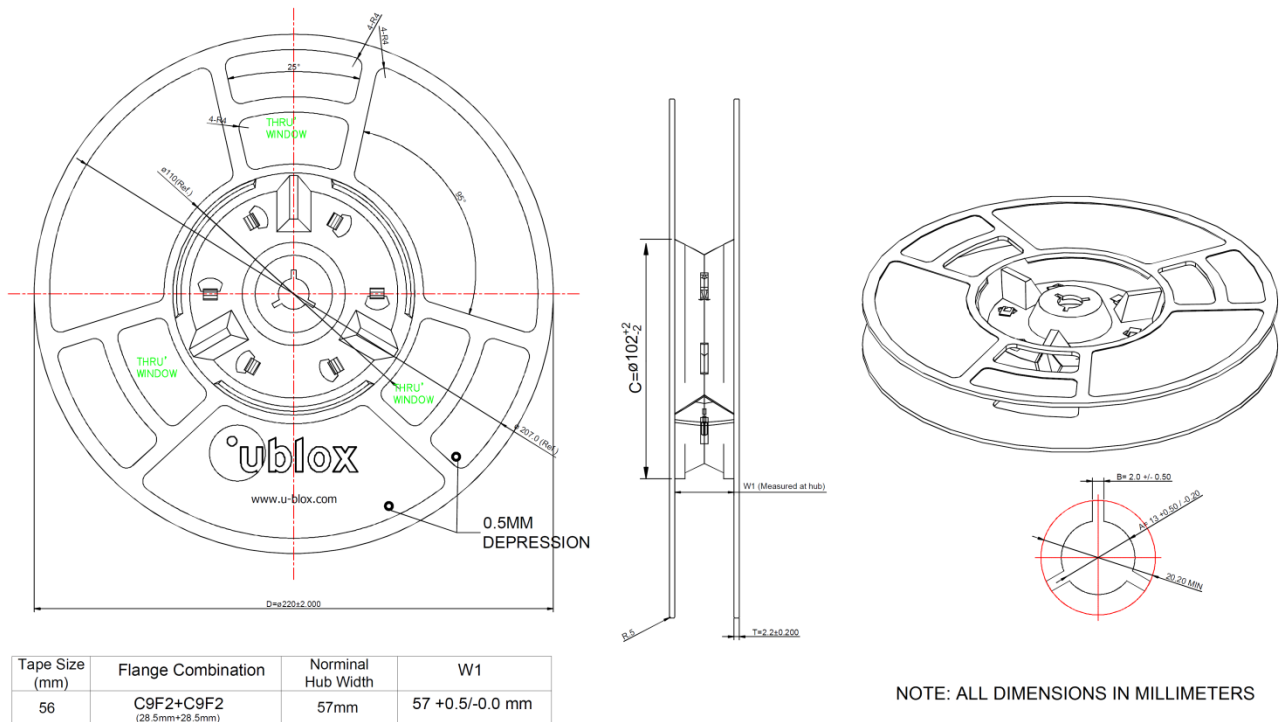

Figure 4: TOBY-R2 series modules reel

| Parameter | Specification |
|-------------------|---------------|
| Reel type | B3 |
| Delivery quantity | 150 |

Table 33: Reel information for TOBY-R2 series modules

Quantities of less than 150 pieces are also available. Contact u-blox for more information.

7.1.2 Tapes

Figure 5 shows the position and the orientation of TOBY-R2 modules as they are delivered on the tape, while the Figure 6 specifies the tape dimensions.

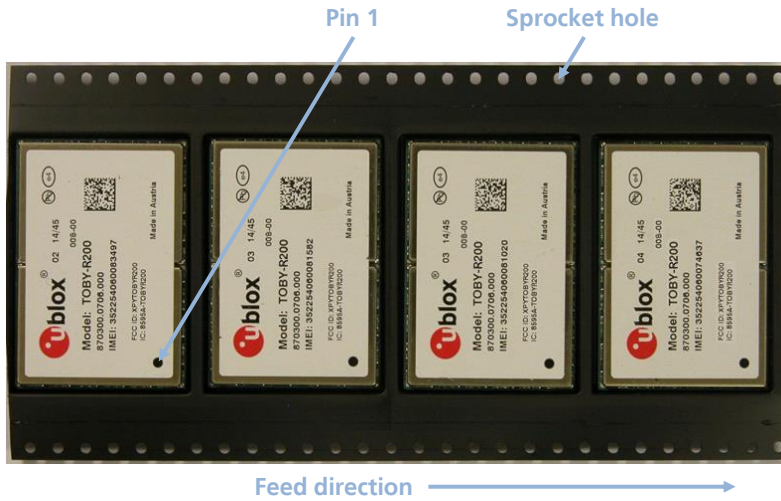

Figure 5: Orientation for TOBY-R2 modules on tape

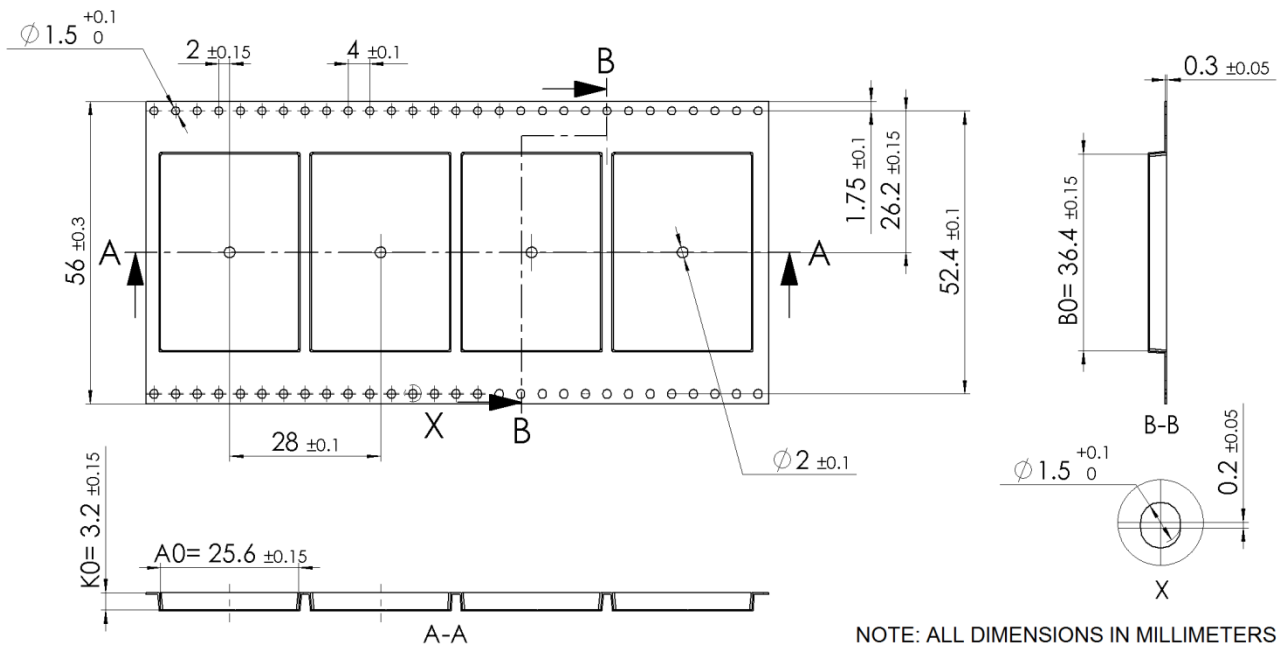



Figure 6: TOBY-R2 series modules tape

7.2 Moisture Sensitivity Levels

-  TOBY-R2 series modules are Moisture Sensitive Devices (MSD) in accordance to the IPC/JEDEC specification.

The Moisture Sensitivity Level (MSL) relates to the packaging and handling precautions required. TOBY-R2 series modules are rated at MSL level 4. For more information regarding moisture sensitivity levels, labeling, storage and drying, see the u-blox Package Information Guide [7].

-  For MSL standard, see IPC/JEDEC J-STD-020 (can be downloaded from www.jedec.org).

7.3 Reflow soldering

Reflow profiles are to be selected according to u-blox recommendations (see TOBY-R2 series System Integration Manual [2]).

-  Failure to observe these recommendations can result in severe damage to the device!

7.4 ESD precautions

-  TOBY-R2 series modules contain highly sensitive electronic circuitry and are Electrostatic Sensitive Devices (ESD). Handling TOBY-R2 series modules without proper ESD protection may destroy or damage them permanently.

TOBY-R2 series modules are Electrostatic Sensitive Devices (ESD) and require special ESD precautions typically applied to ESD sensitive components.

[Table 7](#) reports the maximum ESD ratings of the TOBY-R2 series modules.

Proper ESD handling and packaging procedures must be applied throughout the processing, handling and operation of any application that incorporates TOBY-R2 series module.

ESD precautions should be implemented on the application board where the module is mounted, as described in the TOBY-R2 series System Integration Manual [2].

-  Failure to observe these recommendations can result in severe damage to the device!

8 Default settings

| Interface | AT settings | Comments |
|----------------------|----------------------|--|
| UART interface | AT interface enabled | AT command mode is enabled by default on the UART physical interface |
| | AT+IPR=0 | One-shot automatic baud rate detection enabled |
| | AT+ICF=3,1 | Frame format: 8 bits, no parity, 1 stop bit |
| | |  Since AT+IPR=0 is the default value (one-shot automatic baud rate detection enabled), the AT+ICF value in the profile is not applied (AT+IPR=0 overrules the AT+ICF setting) and the one-shot automatic frame detection is active. |
| | AT&K3 | HW flow control enabled |
| | AT&S1 | DSR line set ON in data mode and set OFF in command mode |
| | AT&D1 | Upon an ON-to-OFF transition of DTR, the module enters online command state and issues an OK result code |
| USB interface | AT&C1 | Circuit 109 changes in accordance with the Carrier detect status; ON if the Carrier is detected, OFF otherwise |
| | MUX disabled | Multiplexing mode can be enabled by AT+CMUX command providing following channels: <ul style="list-style-type: none"> • Channel 0: Multiplexer control • Channel 1 – 5: AT commands / data connection • Channel 6: GNSS data tunneling¹⁸ |
| | Enabled | 6 USB CDCs (Communications Device Class) by default available: <ul style="list-style-type: none"> • USB1: AT and data • USB2: AT and data • USB3: AT and data • USB4: GNSS tunneling¹⁸ • USB5: SAP (SIM Access Profile)¹⁹ • USB6: Primary Log (diagnostic purpose) |
| | AT&K3 | HW flow control enabled |
| | AT&S1 | DSR line set ON in data mode and set OFF in command mode |
| | AT&D1 | Upon an ON-to-OFF transition of DTR, the module enters online command state and issues an OK result code |
| | AT&C1 | Circuit 109 changes in accordance with the Carrier detect status; ON if the Carrier is detected, OFF otherwise |
| Power saving | AT+UPSV=0 | Disabled |
| Network registration | AT+COPS=0 | Self network registration |

Table 34: TOBY-R2 series default settings

See the u-blox AT Commands Manual [\[1\]](#) and the TOBY-R2 series System Integration Manual [\[2\]](#) for information about further settings and factory-programmed values.

¹⁸ Not supported by TOBY-R200-02B-00, TOBY-R202-02B-00

¹⁹ Not supported by "02" product versions

9 Labeling and ordering information

9.1 Product labeling

The labels of TOBY-R2 series modules include important product information as described in this section.

Figure 7 illustrates the label of all the TOBY-R2 series modules, and includes: u-blox logo, production lot, Pb-free marking, product type number, IMEI number, certification numbers, and production country.



Figure 7: TOBY-R2 series module label

9.2 Explanation of codes

Three different product code formats are used. The **Product Name** is used in documentation such as this data sheet and identifies all the u-blox products, independent of packaging and quality grade. The **Ordering Code** includes options and quality, while the **Type Number** includes the hardware and firmware versions. Table 35 details these 3 different formats:

| Format | Structure |
|---------------|------------------|
| Product Name | PPPP-TGVV |
| Ordering Code | PPPP-TGVV-MMQ |
| Type Number | PPPP-TGVV-MMQ-XX |

Table 35: Product code formats

Table 36 explains the parts of the product code.

| Code | Meaning | Example |
|------|--|---------------------|
| PPPP | Form factor | TOBY |
| TG | Platform (Technology and Generation) <ul style="list-style-type: none"> Dominant technology: G: GSM; U: HSUPA; C: CDMA 1xRTT; N: NB-IoT; R: LTE low data rate (Cat 1 and below); L: LTE high data rate (Cat 3 and above) Generation: 1...9 | R2 |
| VV | Variant function set based on the same platform [00...99] | 00 |
| MM | Major product version [00...99] | 02 |
| Q | Product grade <ul style="list-style-type: none"> B = professional A = automotive | B |
| XX | Minor product version (not relevant for certification) | Default value is 00 |

Table 36: Part identification code

9.3 Ordering information

| Ordering No. | Product |
|---------------|---|
| TOBY-R200-02B | Module supporting LTE Cat 1 bands 2 / 4 / 5 / 12, HSPA bands 1 / 2 / 5 / 8, (E)GPRS quad-band. Mainly designed for operation in America (on AT&T network) and other countries. 35.6 x 24.8 x 2.6 mm, 150 pcs/reel |
| TOBY-R202-02B | Module supporting LTE Cat 1 bands 2 / 4 / 5 / 12, HSPA bands 2 / 5. Mainly designed for operation in America (on AT&T network). 35.6 x 24.8 x 2.6 mm, 150 pcs/reel |

Table 37: Product ordering codes

Appendix

A Glossary

| Abbreviation | Definition |
|--------------|---|
| ACM | Abstract Control Model |
| ADC | Analog to Digital Converter |
| BB | Baseband |
| BER | Bit Error Rate |
| BIP | Bearer Independent Protocol |
| CBS | Cell Broadcast Services |
| CDC | Communication Device Class |
| CDMA | Code-Division Multiple Access |
| CE | Certification Mark for EHS compliance in the European Economic Area |
| CLK | Clock |
| CMOS | Complementary Metal-Oxide-Semiconductor |
| CSFB | Circuit-Switched Fall-Back |
| CTS | Clear To Send |
| DC | Direct Current |
| DCD | Data Carrier Detect |
| DCE | Data Communication Equipment |
| DCS | Digital Cellular System |
| DDC | Display Data Channel |
| DL | Down Link (Reception) |
| DRX | Discontinuous Reception |
| DSR | Data Set Ready |
| DTE | Data Terminal Equipment |
| DTMF | Dual Tone Multi Frequency |
| DTR | Data Terminal Ready |
| EDGE | Enhanced Data rates for GSM Evolution |
| EGPRS | Enhanced General Packet Radio Service |
| ERS | External Reset Input Signal |
| ESD | Electrostatic Discharge |
| FCC | Federal Communications Commission |
| FDD | Frequency Division Duplex |
| FOAT | Firmware (update) Over AT commands |
| FOTA | Firmware (update) Over-The-Air |
| FTP | File Transfer Protocol |
| FW | Firmware |
| GDI | Generic Digital Interface |
| GERA | GSM EGPRS Radio Access |
| GMSK | Gaussian Minimum-Shift Keying modulation |
| GND | Ground |
| GNSS | Global Navigation Satellite System |
| GPIO | General Purpose Input/Output |
| GPRS | General Packet Radio Services |
| GSM | Global System for Mobile communications |
| HDLC | High-level Data Link Control |
| HSDPA | High Speed Downlink Packet Access |
| HSIC | High Speed Inter-Chip |
| HSPA | High Speed Packet Access |
| HSUPA | High Speed Uplink Packet Access |

| Abbreviation | Definition |
|--------------|--|
| HTTP | HyperText Transfer Protocol |
| HW | Hardware |
| I/O | Input/Output |
| I2C | Inter-Integrated Circuit |
| I2S | Inter-IC Sound |
| IC | Integrated Circuit |
| IEC | International Electrotechnical Commission |
| IMEI | International Mobile Equipment Identity |
| IMS | IP Multimedia System |
| IP | Internet Protocol |
| ISED | Innovation, Science and Economic Development (Canadian government) |
| ISO | International Organization for Standardization |
| ITU | International Telecommunications Union |
| LGA | Land Grid Array |
| LTE | Long-Term Evolution |
| M2M | Machine to Machine |
| ME | Mobile Equipment |
| MSD | Moisture Sensitive Device |
| MSL | Moisture Sensitivity Level |
| MUX | Multiplexer |
| N/A | Not Applicable |
| NCM | Network Control Model |
| PA | Power Amplifier |
| PCB | Printed Circuit Board |
| PCM | Pulse Code Modulation |
| PCN | Product Change Notification |
| PD | Pull-Down |
| PMU | Power Management Unit |
| PPS | Protocol and Parameter Selection |
| PTCRB | PCS Type Certification Review Board |
| PU | Pull-Up |
| PU/PD | Pull-Up/Pull-Down |
| QPSK | Quadrature Phase Shift Keying |
| RF | Radio Frequency |
| RI | Ring Indicator |
| RIL | Radio Interface Layer |
| RMC | Reference Measurement Channel |
| RTC | Real Time Clock |
| RTS | Request To Send |
| RX | Receive Signal |
| SAP | SIM Access Profile |
| SCL | Serial Clock |
| SDA | Serial Data |
| SDIO | Secure Digital Input Output |
| SIM | Subscriber Identity Module |
| SMS | Short Message Service |
| SSL | Secure Sockets Layer |
| TCP | Transmission Control Protocol |
| TCP/IP | Transmission Control Protocol/Internet Protocol |
| TDMA | Time-Division Multiple Access |
| TLS | Transport Layer Security |

| Abbreviation | Definition |
|--------------|---|
| TS | Technical Specification |
| TXD | Transmit Data |
| UART | Universal Asynchronous Receiver/Transmitter |
| UDP | User Datagram Protocol |
| UE | User Equipment |
| UL | Uplink (Transmission) |
| UMTS | Universal Mobile Telecommunications System |
| URC | Unsolicited Result Code |
| USB | Universal Serial Bus |
| VCC | Voltage Collector Collector |
| WA | Word Alignment |

Table 38: Explanation of the abbreviations and terms used

Related documents

- [1] u-blox AT Commands Manual, Doc. No. UBX-13002752
- [2] u-blox TOBY-R2 series System Integration Manual, Doc. No. UBX-16010572
- [3] u-blox Android RIL Production delivery Application note, Doc. No. UBX-13002041
- [4] u-blox Windows Embedded RIL Production delivery Application note, Doc. No. UBX-13002043
- [5] u-blox GNSS Implementation Application Note, Doc. No. UBX-13001849
- [6] u-blox Mux Implementation Application Note, Doc. No. UBX-13001887
- [7] u-blox Package Information User Guide, Doc. No. UBX-14001652
- [8] 3GPP TS 27.007 - AT command set for User Equipment (UE)
- [9] 3GPP TS 27.005 - Use of Data Terminal Equipment - Data Circuit terminating Equipment (DTE - DCE) interface for Short Message Service (SMS) and Cell Broadcast Service (CBS)
- [10] 3GPP TS 27.010 - Terminal Equipment to User Equipment (TE-UE) multiplexer protocol
- [11] 3GPP TS 36.521-1 - Evolved Universal Terrestrial Radio Access; User Equipment conformance specification; Radio transmission and reception; Part 1: Conformance Testing
- [12] 3GPP TS 34.121-1 - User Equipment conformance specification; Radio transmission and reception (FDD); Part 1: Conformance specification
- [13] 3GPP TS 51.010-1 - Mobile Station conformance specification; Part 1: Conformance specification
- [14] ITU-T Recommendation V24, 02-2000. List of definitions for interchange circuits between Data Terminal Equipment (DTE) and Data Connection Equipment (DCE)
- [15] Universal Serial Bus Revision 2.0 specification, http://www.usb.org/developers/docs/usb20_docs/
- [16] I²C-bus specification and user manual - Rev. 5 - 9 October 2012 - NXP Semiconductors, http://www.nxp.com/documents/user_manual/UM10204.pdf

 For regular updates to u-blox documentation and to receive product change notifications, register on our homepage (www.u-blox.com).

Revision history

| Revision | Date | Name | Comments |
|----------|-------------|------|--|
| R01 | 03-Mar-2016 | sses | Initial release |
| R02 | 31-May-2016 | sses | Improved description of VCC, Power-on, Reset, Host select, UART, USB, GPIO pins |
| R03 | 11-Jul-2016 | sses | Added current consumption and RF performance figures Remarked HSDPA Category 8 Updated description of Power-on, Reset, Host select, UART, USB pins |
| R04 | 22-Sep-2016 | sses | Updated status to Advance Information Updated PWR_ON, ANT_DET, GPIO and Clock Output description. Added 2G current consumption figures. |
| R05 | 10-Oct-2016 | lpah | Document reverted to Objective Specification TOBY-R200-02B prototypes information. Added remark in mechanical specifications. |
| R06 | 22-Dec-2016 | sses | Document applicability updated to TOBY-R200 and TOBY-R202 Updated Power-on and Power-off sections. |
| R07 | 09-Feb-2017 | sses | Updated GPRS / EDGE multi-slot class. Added AC characteristics of I2S pins and other minor characteristics. |
| R08 | 02-Mar-2017 | sses | Updated extended VCC range of TOBY-R200 modules. Updated VUSB_DET pin logical levels input ranges. |
| R09 | 03-Aug-2017 | sses | Extended document applicability to TOBY-R200-02B-01 and TOBY-R202-02B-01 |
| R10 | 22-May-2018 | lpah | Extended document applicability to TOBY-R200-02B-02 and TOBY-R202-02B-02 |
| R11 | 02-Oct-2018 | lpah | Added TOBY-R202 T-Mobile certification |
| R12 | 07-Dec-2018 | lpah | Extended document applicability to TOBY-R200-02B-03 and TOBY-R202-02B-03 |

Contact

For complete contact information, visit us at www.u-blox.com.

u-blox Offices

North, Central and South America

u-blox America, Inc.

Phone: +1 703 483 3180

E-mail: info_us@u-blox.com

Regional Office West Coast:

Phone: +1 408 573 3640

E-mail: info_us@u-blox.com

Technical Support:

Phone: +1 703 483 3185

E-mail: support@u-blox.com

Headquarters

Europe, Middle East, Africa

u-blox AG

Phone: +41 44 722 74 44

E-mail: info@u-blox.com

Support: support@u-blox.com

Asia, Australia, Pacific

u-blox Singapore Pte. Ltd.

Phone: +65 6734 3811

E-mail: info_ap@u-blox.com

Support: support_ap@u-blox.com

Regional Office Australia:

Phone: +61 2 8448 2016

E-mail: info_au@u-blox.com

Support: support_ap@u-blox.com

Regional Office China (Beijing):

Phone: +86 10 68 133 545

E-mail: info_cn@u-blox.com

Support: support_cn@u-blox.com

Regional Office China (Chongqing):

Phone: +86 23 6815 1588

E-mail: info_cn@u-blox.com

Support: support_cn@u-blox.com

Regional Office China (Shanghai):

Phone: +86 21 6090 4832

E-mail: info_cn@u-blox.com

Support: support_cn@u-blox.com

Regional Office China (Shenzhen):

Phone: +86 755 8627 1083

E-mail: info_cn@u-blox.com

Support: support_cn@u-blox.com

Regional Office India:

Phone: +91 80 405 092 00

E-mail: info_in@u-blox.com

Support: support_in@u-blox.com

Regional Office Japan (Osaka):

Phone: +81 6 6941 3660

E-mail: info_jp@u-blox.com

Support: support_jp@u-blox.com

Regional Office Japan (Tokyo):

Phone: +81 3 5775 3850

E-mail: info_jp@u-blox.com

Support: support_jp@u-blox.com

Regional Office Korea:

Phone: +82 2 542 0861

E-mail: info_kr@u-blox.com

Support: support_kr@u-blox.com

Regional Office Taiwan:

Phone: +886 2 2657 1090

E-mail: info_tw@u-blox.com

Support: support_tw@u-blox.com

X-ON Electronics

Largest Supplier of Electrical and Electronic Components

Click to view similar products for [RF Modules](#) category:

Click to view products by [U-Blox](#) manufacturer:

Other Similar products are found below :

[HMC-C009](#) [nRF24L01P-MODULE-PCB](#) [HMC-C001](#) [HMC-C021](#) [HMC-C024](#) [XB9XT-DPRS-721](#) [XBP24BZ7PIT-004J](#) [XBP9B-DMUTB022](#) [nRF24L01P-MODULE-SMA](#) [CMD-KEY2-418-CRE](#) [XM-C92-2P-UA](#) [XB9XT-DPUS-721](#) [V640-A90](#) [HMC-C583](#) [MAAM-008818-TR3000](#) [MTSMC-H5-U](#) [SIMSA868-PRO](#) [SIMSA915C-PRO](#) [SIMSA868C-PRO](#) [SIMSA433C-PRO](#) [SIMSA915-PRO](#) [XBP9B-DMUT-042](#) [HMC-C582](#) [HMC-C022](#) [XBP9B-DPST-041](#) [XBP9B-DMWT-042](#) [SM-MN-00-HF-RC](#) [HMC-C031](#) [MT-02](#) [M1002GB](#) [702-W](#) [SIMSA868C-N-PRO](#) [SIMSA433C-N-PRO](#) [SIMSA915C-N-PRO](#) [PEPPER WIRELESS C1 USB](#) [S2-1050J-Z0K4J](#) [S2-10732-Z1T61](#) [S2-10716-Z1W4E](#) [S2-107ET-Z1W6D](#) [S2-10686-Z1L1D](#) [S2-10688-Z1L1T](#) [S2-106BA-Z1P20](#) [UC15EA-MINIPCIE](#) [SU60-2230C-PU](#) [RC-TFSK3-868](#) [NANO RFID POE](#) [650201424G](#) [H330 A30-00](#) [CMD-HHCP-433-MD](#) [RC-CC1101-SPI-868](#)