

# BIG PROFILES

## DUŽE PROFILE







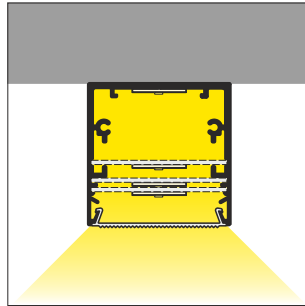
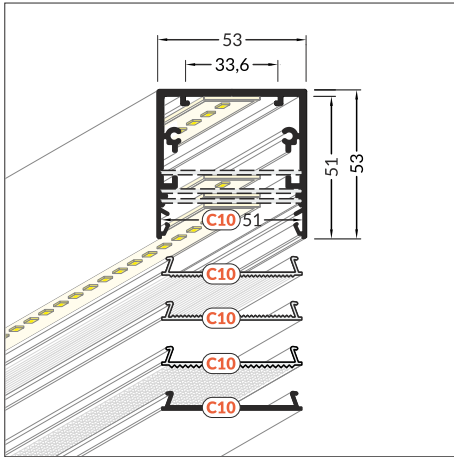

## PHIL53 profile / profil PHIL53



INDEX = 1 pc, length 2000 mm  
INDEX = 1 szt., długość 2000 mm

-  white painted  
biały malowany  
**63530001**
-  anodized  
anodowany  
**63530020**
-  black painted  
czarny malowany  
**63530002**
-  raw aluminium  
surowe aluminium  
**63530000**

Available lengths / Dostępne długości  
1000 mm, 2000 mm, 3000 mm, 4000 mm

## ENDINGS / ZAŚLEPKI

**PHIL53 ending**  
colours: white, silver, black, grey  
material: ABS

zaślepka PHIL53  
kolory: biały, srebrny, czarny, szary  
materiał: ABS

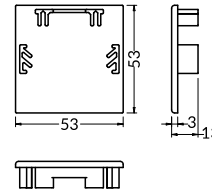



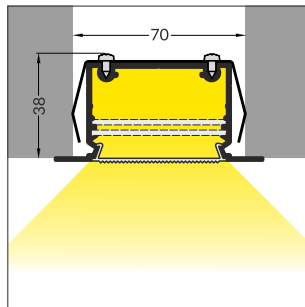
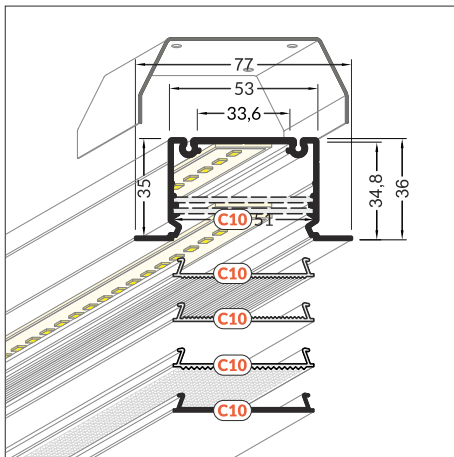

INDEX = 1 set = 2 pcs  
INDEKS = 1 komplet = 2 szt.

-  white  
biały **63640001**
-  silver  
srebrny **63640040**
-  black  
czarny **63640002**
-  grey  
szary **63640022**

## PHIL recessed profile / profil PHIL wpust



INDEX = 1 pc, length 2000 mm  
INDEX = 1 szt., długość 2000 mm

-  white painted  
biały malowany  
**97100001**
-  anodized  
anodowany  
**97100020**
-  black painted  
czarny malowany  
**97100002**
-  raw aluminium  
surowe aluminium  
**97100000**

Available lengths / Dostępne długości  
1000 mm, 2000 mm, 3000 mm, 4000 mm

## MOUNTING / MOCOWANIE

**PHIL recessed holder**  
colour: inox  
material: stainless steel

uchwyt PHIL wpust  
kolor: inox  
materiał: stal nierdzewna

INDEX = 1 set = 2 pcs  
INDEKS = 1 komplet = 2 szt.

 inox  
inox **97510019**

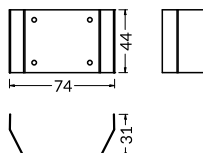

## ENDINGS / ZAŚLEPKI

**PHIL recessed ending**  
colours: white, silver, black  
material: steel

zaślepka PHIL wpust  
kolory: biały, srebrny, czarny  
materiał: stal

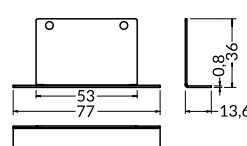

INDEX = 1 set = 2 pcs  
INDEKS = 1 komplet = 2 szt.

-  white  
biały **97120001**
-  silver  
srebrny **97120022**
-  black  
czarny **97120002**



# LOWI profile / profil LOWI

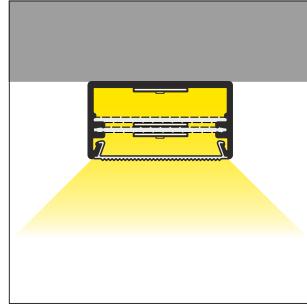
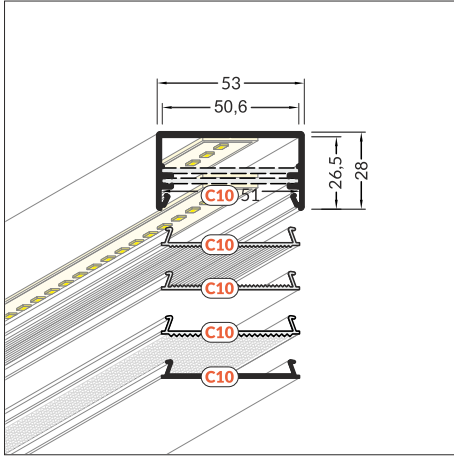

INDEX = 1 pc, length 2000 mm  
INDEKS = 1 szt., długość 2000 mm

-  white painted  
biały malowany  
**93030001**
-  anodized  
anodowany  
**93030020**
-  black painted  
czarny malowany  
**93030002**
-  raw aluminium  
surowe aluminium  
**93030000**

Available lengths / Dostępne długości  
1000 mm, 2000 mm, 3000 mm, 4000 mm

## ENDINGS / ZAŚLEPKI

LOWI ending  
colours: white, silver, black, grey  
material: ABS

zaślepka LOWI  
kolory: biały, srebrny, czarny, szary  
materiał: ABS

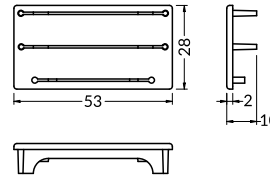

INDEX = 1 set = 2 pcs  
INDEKS = 1 komplet = 2 szt.

-  white  
biały **93040001**
-  silver  
srebrny **93040040**
-  black  
czarny **93040002**
-  grey  
szary **93040022**

## COVERS / KLOSZE

**C10 NARROW cover**  
material: polycarbonate  
klosz C10 NARROW  
materiał: poliwęglan

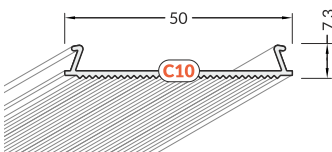

INDEX = 1 pc, length 2000 mm  
INDEKS = 1 szt., długość 2000 mm

**63620000**

**C10 WIDE cover**  
material: polycarbonate  
klosz C10 WIDE  
materiał: poliwęglan

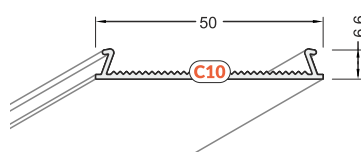

INDEX = 1 pc, length 2000 mm  
INDEKS = 1 szt., długość 2000 mm

**63590000**

**C10 OPAL cover**  
material: PMMA  
klosz C10 OPAL  
materiał: PMMA

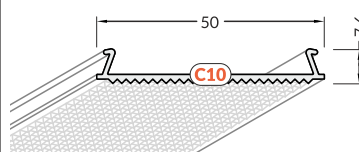

INDEX = 1 pc, length 2000 mm  
INDEKS = 1 szt., długość 2000 mm



**63690038**

## COVER / OSŁONA

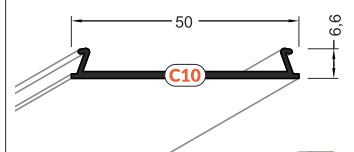
**C10 aluminium cover**  
material: aluminium  
osłona aluminiowa C10  
materiał: aluminium



INDEX = 1 pc, length 2000 mm  
INDEKS = 1 szt., długość 2000 mm

-  white painted  
biały malowany  
**63560001**
-  anodized  
anodowany  
**63560020**
-  black painted  
czarny malowany  
**63560002**
-  raw aluminium  
surowe aluminium  
**63560000**

Available lengths / Dostępne długości  
1000 mm, 2000 mm, 3000 mm, 4000 mm

### Comparison of variations in the light curves measured on different C10 covers Porównanie krzywych światłości przy zastosowaniu różnych kloszy C10

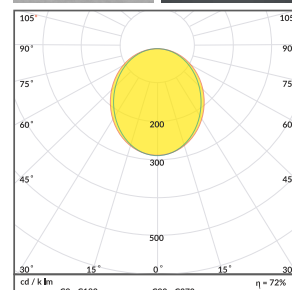
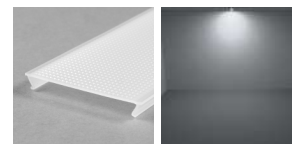
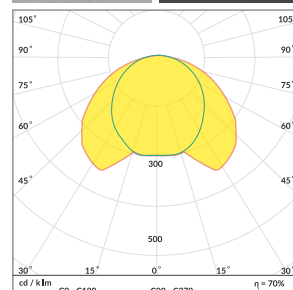
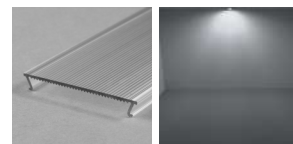
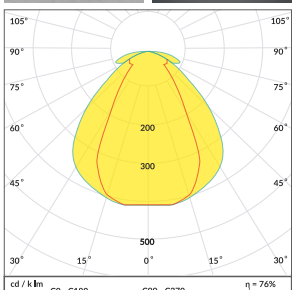
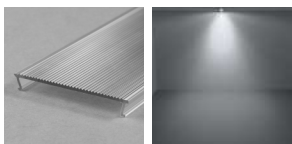



**LED mounting 50**  
material: aluminium  
mocowanie LED 50  
materiał: aluminium

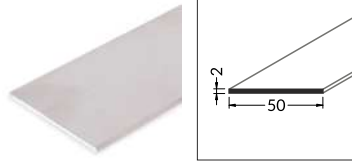

INDEX = 1 pc, length 2000 mm  
INDEX = 1 szt., długość 2000 mm

raw aluminium  
surowe aluminium 25090000

Available lengths / Dostępne długości  
1000 mm, 2000 mm, 3000 mm, 4000 mm

**DIMENSIONS TO INSTALL LIGHT SOURCE**  
**WYMIARY PRZESTRZENI DO ZAMONTOWANIA ŹRÓDŁA ŚWIATŁA**

**profile PHIL53**  
profil PHIL53

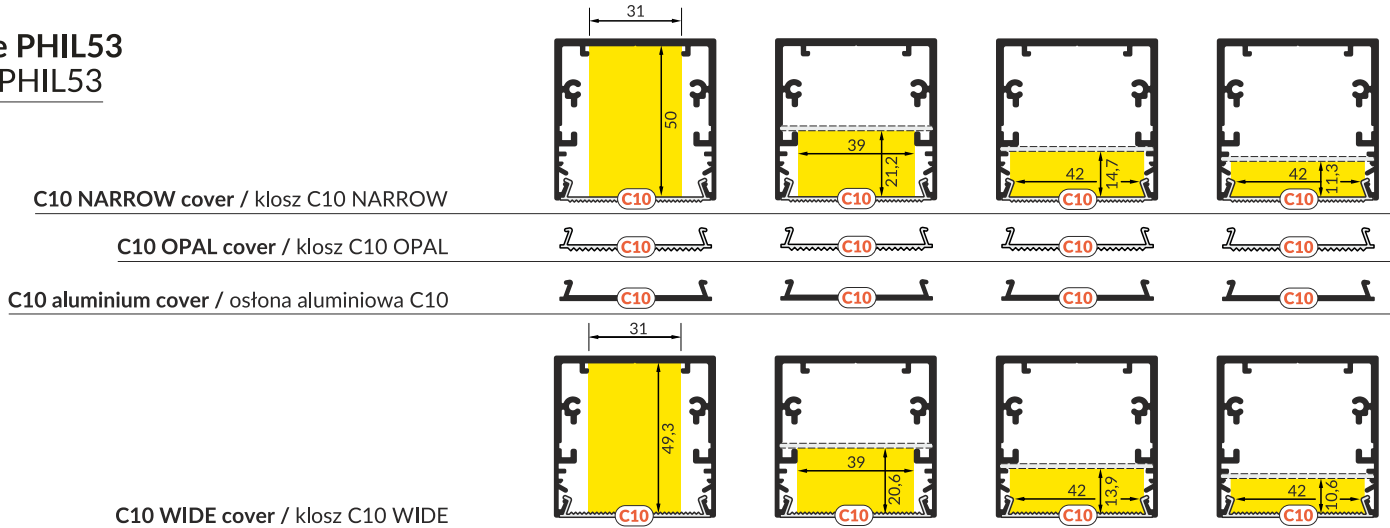

**profile PHIL recessed**  
profil PHIL wpust

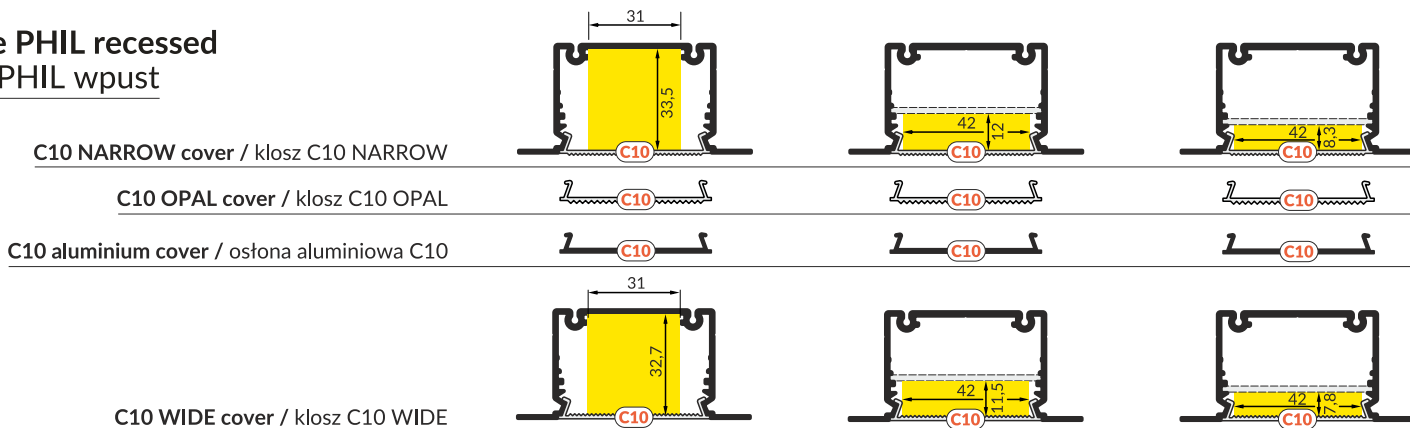

**profile LOWI**  
profil LOWI

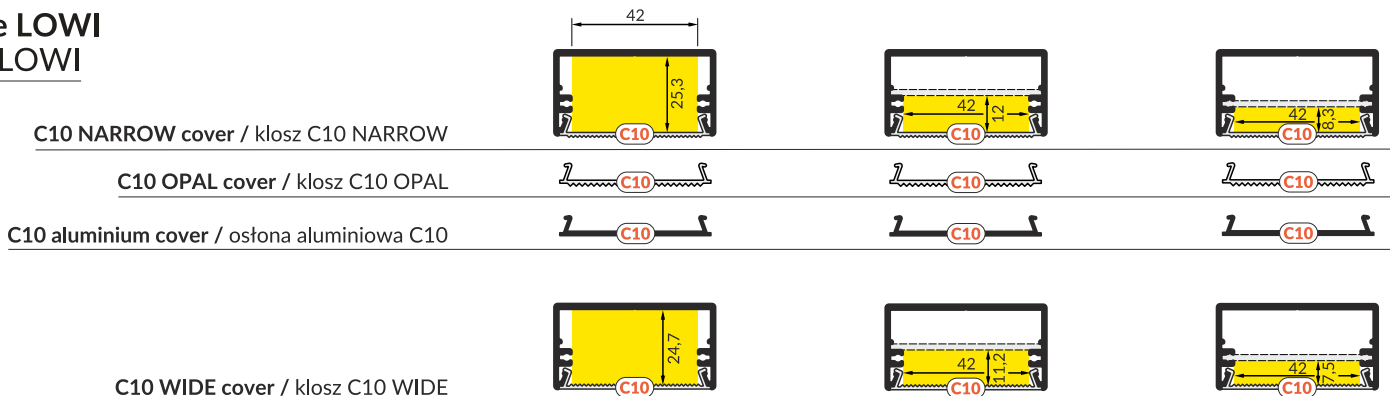

PL

Made in Poland  
Wyprodukowane w Polsce

TOPMET Light Kłosowicz Wiśniewski i Wspólnik Sp. J. ADDRESS: Ostrowska 354, 61-312 Poznań, POLAND  
tel. +48 61 87 27 500, fax. +48 61 87 27 518 biuro@topmet.pl, www.topmet.pl



The catalogue is not an offer under Polish Civil Code regulations. Colours of particular products may vary slightly from colours shown in pictures. The dimensions given are approximate and can not be a reason for complaint. TOPMET Company reserves the right to make technical changes.  
Folder nie stanowi oferty w myśl przepisów Kodeksu Cywilnego. Aktualną ofertę firmy stanowi cennik. Kolory poszczególnych produktów mogą się nieznacznie różnić od kolorów prezentowanych na zdjęciach. Podane wymiary są wymiarami orientacyjnymi i nie mogą stanowić podstawy reklamacji. Firma TOPMET zastrzega sobie prawo do wprowadzania zmian technicznych.

brochure designer • proj. folderu: M. Kędziora, A. Szafran, 02.2017 photo • fot. K. Samuńska, A. Szafran, L. Wesolowski

# X-ON Electronics

Largest Supplier of Electrical and Electronic Components

*Click to view similar products for [LED Lighting Mounting Accessories](#) category:*

*Click to view products by [Topmet](#) manufacturer:*

Other Similar products are found below :

[3635](#) [PALBF18](#) [C16142\\_HEKLA-SOCKET-K](#) [3SU1900-0BC31-0AA0](#) [3SU1900-0BC31-0NB0](#) [2213118-2](#) [47.319.6380.50](#) [3SU1401-2BB40-1AA0](#) [3SU1401-2BB60-1AA0](#) [1SFA611621R1041](#) [23110040](#) [23120022](#) [23130000](#) [68550022](#) [68550040](#) [70290000](#) [70290022](#) [70290040](#) [70300022](#) [70300040](#) [76620000](#) [76990022](#) [77280022](#) [77980022](#) [77990001](#) [77990002](#) [77990040](#) [83130001](#) [83130040](#) [83150001](#) [83150022](#) [83150040](#) [83980001](#) [83980040](#) [83990001](#) [83990022](#) [83990040](#) [84040022](#) [84510002](#) [86050038](#) [86180003](#) [89080002](#) [89080022](#) [89140002](#) [89980002](#) [89980019](#) [98050040](#) [A1070001](#) [A1070002](#) [A2070001](#)