



CORNER27 G/UX

LARGE-SIZE ANGULAR PROFILE

WIELKOGABARYTOWY PROFIL KĄTOWY

- lighting profile - possibility of high lumen output
- hidden mounting
- two lighting angles: 30° or 60°
- maximum LED strip width: 27 mm or 3 standard strips (8 mm)
- profil oświetleniowy - możliwość uzyskania dużej wydajności
- ukryte mocowanie
- dwa kąty świecenia: 30 i 60°
- maksymalna szerokość taśmy LED: 27 mm albo do 3 taśm standardowych (8 mm)

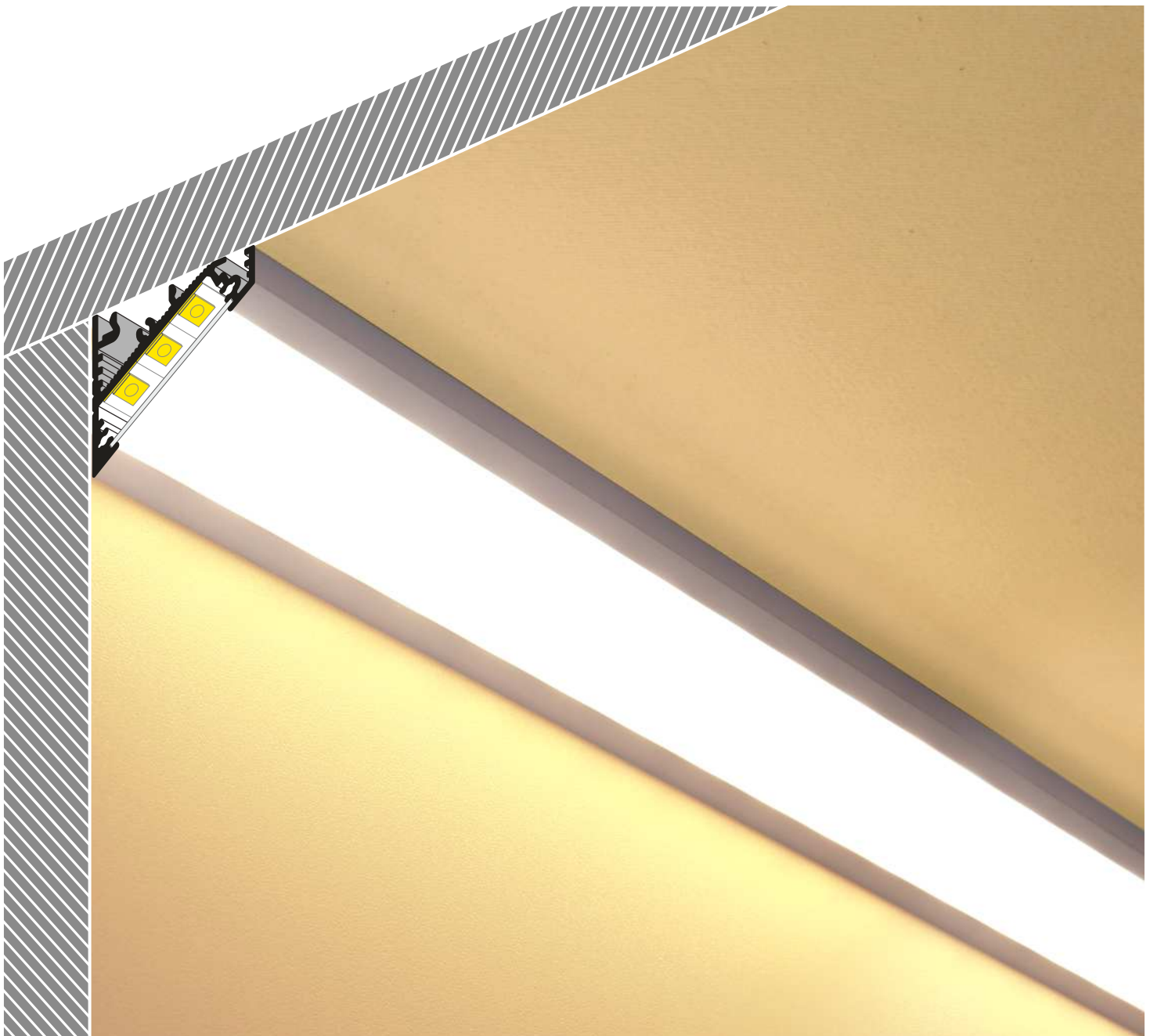

SIMILAR IN THE OFFER / PODOBNE W OFERCIE



TRIO10
BC



CORNER10
BC/UX



QUARTER10
BD/U6



CABI12
E



CORNER14
EF/TY



CORNER27 G/UX

- G** slide cover
klosz G wsuwany
- U¹** U flexible mounting plate
uchwyt U sprężysty
- U²** cone U flexible mounting plate
uchwyt U sprężysty cone
- X¹** X mounting plate
uchwyt X

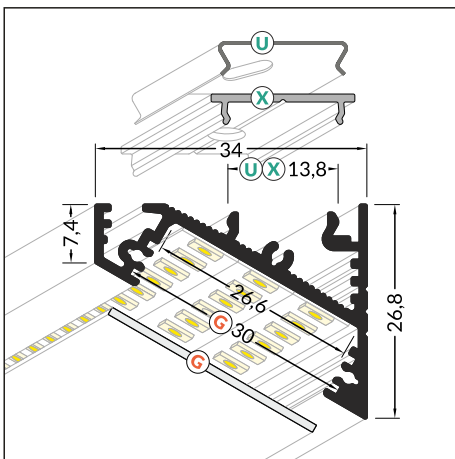
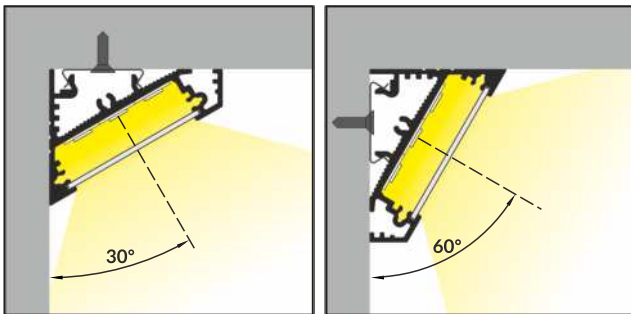
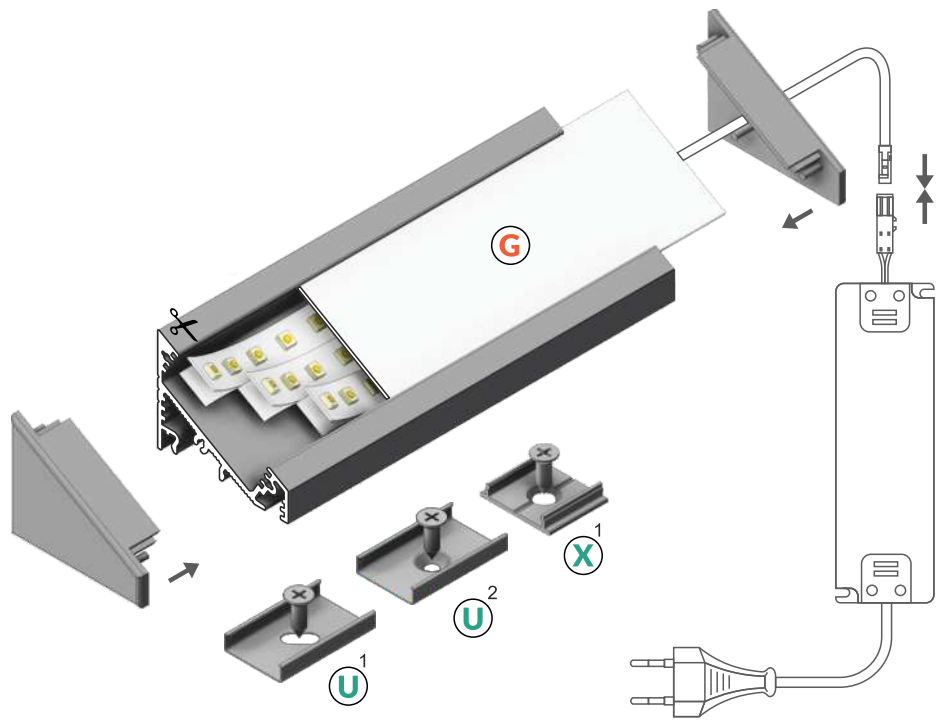

INDEX = 1 pc, length 2000 mm
package = 10 pcs
INDEKS = 1 szt., długość 2000 mm
opakowanie = 10 szt.

○ white painted
biały malowany
98030001

● anodized
anodowany
98030020

● black anodized
czarny anodowany
98030021

Available lengths / Dostępne długości
1000 mm, 2000 mm, 3000 mm, 4000 mm

○ max 27 mm

◻ corner
kątowy



COVERS / KLOSZE

G slide cover

colours: transparent, frosted, white
material: PC, PP, PP

klosz G wsuwany
kolory: transparentny, szron, mleczny
materiał: PC, PP, PP



Note! Dimensions of the space to install LED source
Uwaga! Wymiary przestrzeni do zamontowania źródła LED

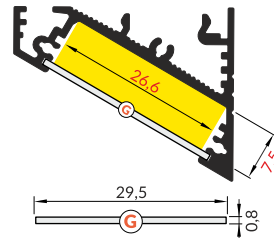

INDEX = 1 pc, length 2000 mm
package = 10 pcs
INDEKS = 1 szt., długość 2000 mm
opakowanie = 10 szt.

G transparent / G transparentny
84070016

G frosted / G szron
84070039

G white / G mleczny
84070038

ENDINGS / ZAŚLEPKI

CORNER27 ending

colours: white, silver, black, grey
material: ABS

zaślepka CORNER27
kolory: biały, srebrny, czarny, szary
materiał: ABS

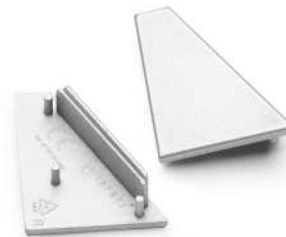
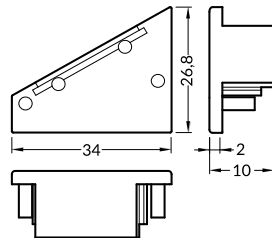

INDEX = 1 set,
package of 10 sets = 20 pcs
INDEKS = 1 komplet, opakowanie
zawiera 10 kompletów = 20 szt.

white
białe 98050001

silver
srebrne 98050040

black
czarne 98050002

grey
szare 98050022

MOUNTINGS / MOCOWANIA

U flexible mounting plate

colour: inox
material: stainless steel

uchwyt U sprężysty
kolor: inox
materiał: stal nierdzewna

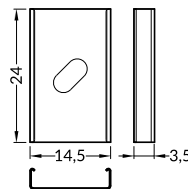
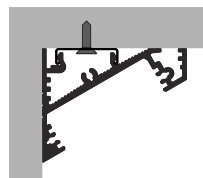

INDEX = 1 set
package of 10 sets = 20 pcs
INDEKS = 1 komplet
opakowanie zawiera 10 kpl = 20 szt

U flexible mounting plate
uchwyt U sprężysty

inox
inox 76380000

cone U flexible mounting plate

colour: inox
material: stainless steel

uchwyt U sprężysty cone
kolor: inox
materiał: stal nierdzewna

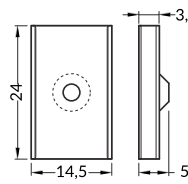
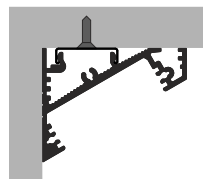

cone U flexible mounting plate
uchwyt U sprężysty cone

inox
inox 76620000

X mounting plate

colour: raw aluminium
material: aluminium

uchwyt X
kolor: surowe aluminium
materiał: aluminium

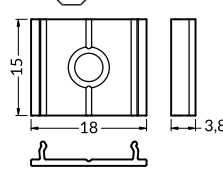
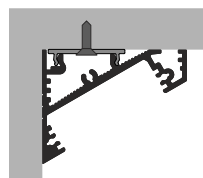

X mounting plate
uchwyt X

raw aluminium
surowe aluminium 76260000

CONNECTORS / ŁĄCZNIKI

X connector

colour: raw aluminium
material: aluminium

łącznik X
kolor: surowe aluminium
materiał: aluminium

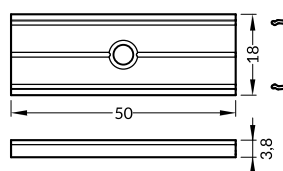

INDEX = 1 set
INDEKS = 1 komplet

raw aluminium
surowe aluminium 76350000



Made in Poland
Wyprodukowane w Polsce



EU-registered industrial design
Wzory przemysłowe EU

TOPMET LIGHT Kłosowicz Wiśniewski i Wspólnik Sp. j. ADDRESS: Ostrowska 354, 61-312 Poznań, POLAND
tel. +48 61 87 27 500, fax. +48 61 87 27 518 biuro@topmet.pl, www.topmet.pl

The catalogue is not an offer under Polish Civil Code regulations. Colours of particular products may vary slightly from colours shown in pictures. The dimensions given are approximate and can not be a reason for complaint. TOPMET Company reserves the right to make technical changes.
Folder nie stanowi oferty w myśl przepisów Kodeksu Cywilnego. Aktualną ofertę firmy stanowi cennik. Kolory poszczególnych produktów mogą się nieznacznie różnić od kolorów prezentowanych na zdjęciach. Podane wymiary są wymiarami orientacyjnymi i nie mogą stanowić podstawy reklamacji. Firma TOPMET zastrzega sobie prawo do wprowadzania zmian technicznych.

brochure designer • proj. folderu: M. Kędziora, A. Szafran 11.2016. photo • fot. A. Szafran, A. Wierdak, L. Wesolowski



X-ON Electronics

Largest Supplier of Electrical and Electronic Components

Click to view similar products for [Screws & Fasteners](#) category:

Click to view products by [Topmet](#) manufacturer:

Other Similar products are found below :

[5721-1440-1/4-SS](#) [593503FX](#) [0098.0093](#) [0098.0094](#) [0098.9206](#) [0098.9219](#) [0098.9221](#) [0098.9262](#) [596-2114-013](#) [59781-1](#) [59781-4](#)
[0098.0026](#) [0098.9210](#) [0098.9212](#) [60227-01](#) [60227-04](#) [60227-08](#) [60228-09](#) [618-00001](#) [62153-03](#) [62153-11](#) [M316-KSSTMCZ100](#) [M3440-SS](#)
[M3442-SS](#) [M3448-SS](#) [6291A](#) [6292-1](#) [6-306105-9](#) [6-306131-4](#) [690432-1](#) [700989](#) [7-18023-1](#) [7-21002-8](#) [7230-3](#) [7235-3](#) [7248-1](#) [7248-2](#)
[748174-2](#) [F03-02](#) [SUS316](#) [F1209](#) [80011](#) [809704-1](#) [864LW](#) [8700](#) [8860220](#) [9047](#) [95000002B](#) [9521](#) [9885-2](#) [992326-6](#)