



**Model Number**

**UB4000-F42-I-V15**

Single head system

**Features**

- **Analogue output 4 mA ... 20 mA**
- **Extremely small unusable area**
- **TEACH-IN**
- **Interference suppression (adjustable width of sound cone in close range)**
- **Temperature compensation**
- **Synchronization options**
- **Mode of operation adjustable**

**Curves**

**Characteristic response curve**

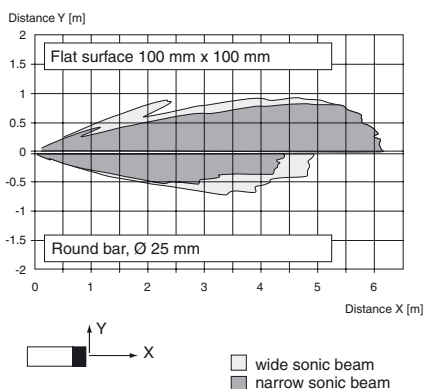

Release date: 2009-10-22 13:22 Date of issue: 2009-10-22 13:4003\_ENG.xml

**Technical data**

**General specifications**

Sensing range	200 ... 4000 mm
Adjustment range	240 ... 4000 mm
Unusable area	0 ... 200 mm
Standard target plate	100 mm x 100 mm
Transducer frequency	approx. 85 kHz
Response delay	approx. 325 ms

**Indicators/operating means**

LED green	permanently green: Power on
LED yellow	permanent: object in evaluation range flashing: program function
LED red	normal operation: "fault" program function: no object detected

**Electrical specifications**

Operating voltage $U_B$	10 ... 30 V DC , ripple 10 % <sub>SS</sub>
No-load supply current $I_0$	≤ 60 mA

**Input/output**

Synchronization	bi-directional 0 level: $-U_B \dots +1$ V 1 level: $+4$ V $\dots +U_B$ input impedance: > 12 KOhm synchronization pulse: ≥ 100 μs, synchronization interpulse period: ≥ 2 ms
Synchronization frequency	
Common mode operation	≤ 13 Hz
Multiplex operation	≤ 13/n Hz, n = number of sensors

**Output**

Output type	1 analogue output 4 ... 20 mA
Default setting	evaluation limit A1: 240 mm , evaluation limit A2: 4000 mm , wide beam width
Resolution	0.7 mm
Deviation of the characteristic curve	± 1 % of full-scale value
Repeat accuracy	± 0.1 % of full-scale value
Load impedance	0 ... 300 Ohm
Temperature influence	± 1 % of full-scale value

**Ambient conditions**

Ambient temperature	-25 ... 70 °C (248 ... 343 K)
Storage temperature	-40 ... 85 °C (233 ... 358 K)

**Mechanical specifications**

Protection degree	IP54
Connection	connector V15 (M12 x 1), 5 pin
Material	
Housing	ABS
Transducer	epoxy resin/hollow glass sphere mixture; foam polyurethane, cover PBT
Mass	150 g

**Compliance with standards and directives**

Standard conformity	
Standards	EN 60947-5-7:2003 IEC 60947-5-7:2003

**Dimensions**

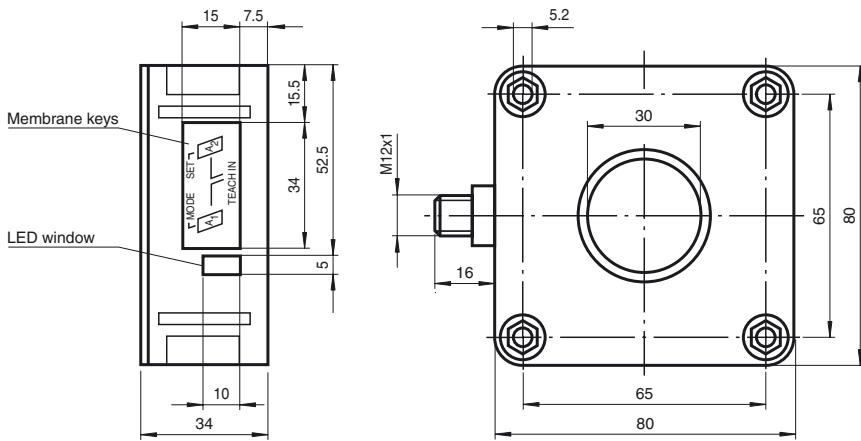

**Additional Information**

**Analogue output programming**

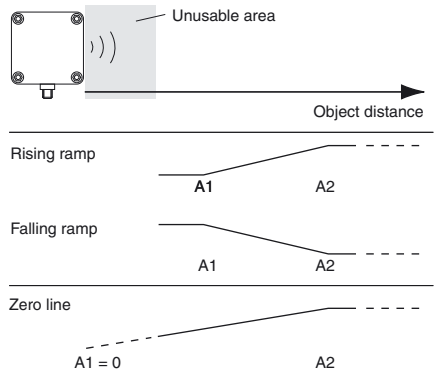

**Electrical Connection**

Standard symbol/Connections:  
(version I)

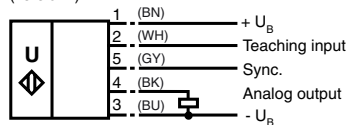

Core colours in accordance with EN 60947-5-2.

**Pinout**

**Connector V15**



**Functional Description**

The sensor may be completely parameterised via two keys on the side panel of the housing. As a special feature provided by this sensor, the ultrasound beam width may be adapted to the environmental conditions at the place of operation of the sensor.

**Specifying the evaluation limits:**

The evaluation limits determine the characteristic line and the working range of the analog output.

**Accessories**

**MH 04-3505**

Mounting aid

**MHW 11**

Mounting aid

**DA5-IU-2K-V**

Process control and indication equipment

**V15-G-2M-PVC**

Cable connector

**V15-W-2M-PUR**

Cable connector

Specifying the A1 evaluation limit by pressing the A1 key	
Holding down the A1 key > 2 seconds	The sensor switches to learn mode and the user may specify the A1 evaluation limit
Position the target object at the desired distance	The yellow LED of the sensor flashes fast to indicate that the target object is recognised. The red LED flashes if the object is not recognised.
Briefly pressing the A1 key	The sensor terminates the specification of the A1 evaluation limit and saves it as a non-volatile value. The specified value is invalid if the object is uncertain (i.e. the red LED lights up at irregular intervals). The learn mode is exited.

The A2 evaluation limit is specified via the A2 key, analogous to the description above.

Alternatively, the evaluation limits may also be specified electrically via the learn input. To specify the A1 evaluation limit, the learn input must be connected to  $-U_B$ ; to specify the A2 evaluation limit, it must be connected to  $+U_B$ . Specified values are saved upon the disconnection from the learn input.





Evaluation limits may only be specified within the first 5 minutes after Power on. To modify the evaluation limits later, the user may specify the desired values only after a new Power On.

**Proceed as follows to parameterise the output function and the ultrasound beam width:**

Press the A1 key during Power on and hold down the key for another second to ensure that the sensor starts the two-step parameterisation of the operating modes.

**Step 1, parameterisation of the output function**

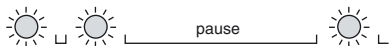
The output function parameterised last is displayed. All output functions available may be selected via consecutive, brief strokes of the A2 key. These strokes are visualised via short flashes of the green LED.

Operating mode	Flash sequence of the green LED	A2 key
Rising edge		
Falling edge		
Zero point straight line		





The "Zero point straight line" setting fixedly specifies the A1 evaluation limit to 0 (see specification of the evaluation limits). The A2 evaluation limit determines the steepness of the output characteristic line.

Hold down the A1 key for 2 seconds to save the selected output mode, complete the parameterisation and ensure that the sensor returns to normal mode. If you briefly press the A1 key, Step 2 is entered (parameterisation of the ultrasound beam width).

**Step 2, parameterisation of the ultrasound beam width**

Via Step 2, the ultrasound beam width may be adapted to the requirements of the corresponding application.

The beam width parameterised last is displayed first. Available beam width settings may be selected via consecutive, brief strokes of the A2 key. These strokes are visualised via the flash sequence of the red LED.

Beam width	Flash sequence of the red LED	A2 key
Small beam		
Medium beam		
Large beam		

Hold down the A1 key for 2 seconds to save the selected beam shape, terminate the parameterisation and ensure that the sensor returns to normal mode. Briefly press the A1 key to return to Step 1 (parameterisation of the output function).

If the parameterisation mode is not terminated within 5 minutes (hold down the A1 key for 2 seconds), the sensor aborts this mode without modifying the settings.

**Synchronisation**

The sensor provides a synchronisation port to suppress mutual influencing. If this port has not been connected, the sensor works at an internally generated cycle rate. Several sensors may be synchronised via the following options.

**External synchronisation:**

The sensor may be synchronised via the external application of a square wave voltage. A synchronisation pulse on the synchronisation input initiates a measuring cycle. The pulse width must be greater than 100  $\mu$ s. The measuring cycle is started with the falling edge. A low level > 1 s or an open synchronisation input initiate the transition to normal sensor mode. A high level on the synchronisation input deactivates the sensor.

Release date: 2009-10-22 13:22 Date of issue: 2009-10-22 13:4003\_ENG.xml

Two modes are possible:

- Several sensors are controlled via the same synchronisation signal. The sensors work in common mode.
- The synchronisation pulses are forwarded at cyclic intervals to respectively one single sensor. The sensors work in multiplex mode.

Self-synchronisation:

The synchronisation ports of up to 5 sensors suitable for self-synchronisation are connected to each other. These sensors work in multiplex mode after Power on. The On delay increases depending on the number of sensors to be synchronised. While the learn mode is active, no synchronisation is possible (and vice-versa). To specify the switching points, the sensors must be operated in non-synchronised mode.

**Note:**

If the synchronisation option is not used, the synchronisation input must be connected to ground (0V) or the sensor must be operated with a (4-pole) V1 connecting cable.

## X-ON Electronics

Largest Supplier of Electrical and Electronic Components

*Click to view similar products for [Proximity Sensors](#) category:*

*Click to view products by [Pepperl & Fuchs](#) manufacturer:*

Other Similar products are found below :

[01.001.5653.1](#) [70.340.1028.0](#) [70.360.2428.0](#) [70.364.4828.0](#) [70.810.1053.0](#) [72.360.1628.0](#) [73.363.6428.0](#) [980659-1](#) [QT-12](#)  
[E2ECQC2D1M1GJT03M](#) [E2EX10D1NN](#) [E2E-X14MD1-G](#) [E2E-X2D1-G](#) [E2EX2ME2N](#) [E2E-X3D1-N](#) [10M](#) [E2E-X4MD1-G](#)  
[E2FMX1R5D12M](#) [E2K-F10MC1](#) [5M](#) [EC3016PPASL-1](#) [EI1204TBOSL-6](#) [EI5515NPAP](#) [BSA-08-25-08](#) [IC08ANC15PO-K](#) [25.161.3253.0](#)  
[25.332.0653.1](#) [25.352.0653.0](#) [25.352.0753.0](#) [25.523.3253.0](#) [922FS1.5C-A4P-Z774](#) [SC606ABV0S30](#) [SM552A100](#) [SM952A126100LE](#)  
[SM956A132600](#) [A1220EUA-T](#) [F3S-A162-U](#) [CL18](#) [QT-08L](#) [34.110.0010.0](#) [TL-C2MF1-M3-E4](#) [IA08BLF15NOM5](#) [IA08BSF15NOM5](#)  
[IA12ASF04DOM1](#) [IS2](#) [IS31SE5000-UTLS2-TR](#) [34.110.0021.0](#) [34.110.0022.0](#) [CA150-120VACDC](#) [VM18VA3000Q](#) [XS508BSCBL2](#)  
[XS512BLNAM12](#)