

# **BK PRECISION<sup>®</sup>**

## 9130B Series Triple Output Programmable DC Power Supplies

Models: 9130B, 9131B, 9132B

### USER MANUAL



# Safety Summary

The following safety precautions apply to both operating and maintenance personnel and must be followed during all phases of operation, service, and repair of this instrument.

## **WARNING**

Before applying power to this instrument:

- Read and understand the safety and operational information in this manual.
- Apply all the listed safety precautions.
- Verify that the voltage selector at the line power cord input is set to the correct line voltage. Operating the instrument at an incorrect line voltage will void the warranty.
- Make all connections to the instrument before applying power.
- Do not operate the instrument in ways not specified by this manual or by B&K Precision.

Failure to comply with these precautions or with warnings elsewhere in this manual violates the safety standards of design, manufacture, and intended use of the instrument. B&K Precision assumes no liability for a customer's failure to comply with these requirements.

### *Category rating*

The IEC 61010 standard defines safety category ratings that specify the amount of electrical energy available and the voltage impulses that may occur on electrical conductors associated with these category ratings. The category rating is a Roman numeral of I, II, III, or IV. This rating is also accompanied by a maximum voltage of the circuit to be tested, which defines the voltage impulses expected and required insulation clearances. These categories are:

Category I (CAT I): Measurement instruments whose measurement inputs are not intended to be connected to the mains supply. The voltages in the environment are typically derived from a limited-energy transformer or a battery.

Category II (CAT II): Measurement instruments whose measurement inputs are meant to be connected to the mains supply at a standard wall outlet or similar sources. Example measurement environments are portable tools and household appliances.

Category III (CAT III): Measurement instruments whose measurement inputs are meant to be connected to the mains installation of a building. Examples are measurements inside a building's circuit breaker panel or the wiring of permanently-installed motors.

Category IV (CAT IV): Measurement instruments whose measurement inputs are meant to be connected to the primary power entering a building or other outdoor wiring.

## **WARNING**

Do not use this instrument in an electrical environment with a higher category rating than what

is specified in this manual for this instrument.

## **WARNING**

You must ensure that each accessory you use with this instrument has a category rating equal to or higher than the instrument's category rating to maintain the instrument's category rating. Failure to do so will lower the category rating of the measuring system.

### *Electrical Power*

This instrument is intended to be powered from a CATEGORY II mains power environment. The mains power should be 120 V RMS or 240 V RMS. Use only the power cord supplied with the instrument and ensure it is appropriate for your country of use.

### *Ground the Instrument*

## **WARNING**

To minimize shock hazard, the instrument chassis and cabinet must be connected to an electrical safety ground. This instrument is grounded through the ground conductor of the supplied, three-conductor AC line power cable. The power cable must be plugged into an approved three-conductor electrical outlet. The power jack and mating plug of the power cable meet IEC safety standards.

## **WARNING**

Do not alter or defeat the ground connection. Without the safety ground connection, all accessible conductive parts (including control knobs) may provide an electric shock. Failure to use a properly-grounded approved outlet and the recommended three-conductor AC line power cable may result in injury or death.

## **WARNING**

Unless otherwise stated, a ground connection on the instrument's front or rear panel is for a reference of potential only and is not to be used as a safety ground.

### *Do not operate in an explosive or flammable atmosphere*

## **WARNING**

Do not operate the instrument in the presence of flammable gases or vapors, fumes, or finely-divided particulates.

## **WARNING**

The instrument is designed to be used in office-type indoor environments. Do not operate the instrument

- In the presence of noxious, corrosive, or flammable fumes, gases, vapors, chemicals, or finely-divided particulates.
- In relative humidity conditions outside the instrument's specifications.
- In environments where there is a danger of any liquid being spilled on the instrument or

where any liquid can condense on the instrument.

- In air temperatures exceeding the specified operating temperatures.
- In atmospheric pressures outside the specified altitude limits or where the surrounding gas is not air.
- In environments with restricted cooling air flow, even if the air temperatures are within specifications.
- In direct sunlight.

## CAUTION

This instrument is intended to be used in an indoor pollution degree 2 environment. The operating temperature range is 0 °C to 40 °C and the operating humidity range is up to 80% relative humidity with no condensation allowed.

Measurements made by this instrument may be outside specifications if the instrument is used in non-office-type environments. Such environments may include rapid temperature or humidity changes, sunlight, vibration and/or mechanical shocks, acoustic noise, electrical noise, strong electric fields, or strong magnetic fields.

### *Do not operate instrument if damaged*

If the instrument is damaged, appears to be damaged, or if any liquid, chemical, or other material gets on or inside the instrument, remove the instrument's power cord, remove the instrument from service, label it as not to be operated, and return the instrument to B&K Precision for repair. Notify B&K Precision of the nature of any contamination of the instrument.

### *Clean the instrument only as instructed*

Do not clean the instrument, its switches, or its terminals with contact cleaners, abrasives, lubricants, solvents, acids/bases, or other such chemicals. Clean the instrument only with a clean dry lint-free cloth or as instructed in this manual.

### *Not for critical applications*

## WARNING

This instrument is not authorized for use in contact with the human body or for use as a component in a life-support device or system.

### *Do not touch live circuits*

## WARNING

Instrument covers must not be removed by operating personnel. Component replacement and internal adjustments must be made by qualified service-trained maintenance personnel who are aware of the hazards involved when the instrument's covers and shields are removed. Under certain conditions, even with the power cord removed, dangerous voltages may exist

when the covers are removed. To avoid injuries, always disconnect the power cord from the instrument, disconnect all other connections (for example, test leads, computer interface cables, etc.), discharge all circuits, and verify there are no hazardous voltages present on any conductors by measurements with a properly-operating voltage-sensing device before touching any internal parts. Verify the voltage-sensing device is working properly before and after making the measurements by testing with known-operating voltage sources and test for both DC and AC voltages. Do not attempt any service or adjustment unless another person capable of rendering first aid and resuscitation is present.

Do not insert any object into an instrument's ventilation openings or other openings.

### **WARNING**

Hazardous voltages may be present in unexpected locations in circuitry being tested when a fault condition in the circuit exists.

#### *Fuse replacement*

### **WARNING**

Fuse replacement must be done by qualified service-trained maintenance personnel who are aware of the instrument's fuse requirements and safe replacement procedures. Disconnect the instrument from the power line before replacing fuses. Replace fuses only with new fuses of the fuse types, voltage ratings, and current ratings specified in this manual or on the back of the instrument. Failure to do so may damage the instrument, lead to a safety hazard, or cause a fire. Failure to use the specified fuses will void the warranty.

#### *Servicing*

### **CAUTION**

Do not substitute parts that are not approved by B&K Precision or modify this instrument. Return the instrument to B&K Precision for service and repair to ensure that safety and performance features are maintained.

#### *Cooling fans*

### **CAUTION**

This instrument contains one or more cooling fans. For continued safe operation of the instrument, the air inlet and exhaust openings for these fans must not be blocked nor must accumulated dust or other debris be allowed to reduce air flow. Maintain at least 25 mm clearance around the sides of the instrument that contain air inlet and exhaust ports. If mounted in a rack, position power devices in the rack above the instrument to minimize instrument heating while rack mounted. Do not continue to operate the instrument if you cannot verify the fan is operating (note some fans may have intermittent duty cycles). Do not insert any object into the fan's inlet or outlet.

*Use correctly sized wires*

**⚠ WARNING**

To connect a load to the power supply, use a wire diameter large enough to handle the maximum continuous output short-circuit current of the power supply without the wire overheating.

*For continued safe use of the instrument*

- Do not place heavy objects on the instrument.
- Do not obstruct cooling air flow to the instrument.
- Do not place a hot soldering iron on the instrument.
- Do not pull the instrument with the power cord, connected probe, or connected test lead.
- Do not move the instrument when a probe is connected to a circuit being tested

## Compliance Statements

Disposal of Old Electrical & Electronic Equipment (Applicable in the European Union and other European countries with separate collection systems)

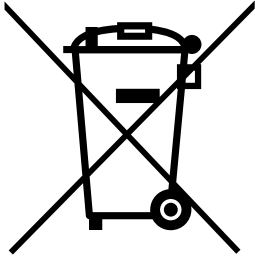

This product is subject to Directive 2002/96/EC of the European Parliament and the Council of the European Union on waste electrical and electronic equipment (WEEE), and in jurisdictions adopting that Directive, is marked as being put on the market after August 13, 2005, and should not be disposed of as unsorted municipal waste. Please utilize your local WEEE collection facilities in the disposition of this product and otherwise observe all applicable requirements.

# CE Declaration of Conformity

This instrument meets the requirements of 2006/95/EC Low Voltage Directive and 2004/108/EC Electromagnetic Compatibility Directive with the following standards.

## Low Voltage Directive











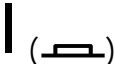

- EN61010-1: 2001

## EMC Directive

- EN 61000-3-2: 2006
- EN 61000-3-3: 1995+A1: 2001+A2: 2005
- EN 61000-4-2 / -3 / -4 / -5 / -6 / -11
- EN 61326-1: 2006



## Safety Symbols

	Refer to the user manual for warning information to avoid hazard or personal injury and prevent damage to instrument.
	Electric Shock hazard
	On (Supply). This is the AC mains connect/disconnect switch on the front of the instrument.
	Off (Supply). This is the AC mains connect/disconnect switch on the front of the instrument.
	Direct current
	Alternating current
	Fuse Symbol
	Chassis (earth ground) symbol
	Ground terminal
	Protective earth ground
	CAUTION indicates a hazardous situation which, if not avoided, will result in minor or moderate injury
	WARNING indicates a hazardous situation which, if not avoided, could result in death or serious injury
	DANGER indicates a hazardous situation which, if not avoided, will result in death or serious injury.

# Table of Contents

Compliance Statements .....	vii
Safety Symbols .....	ix
<b>1 General Information .....</b>	<b>1</b>
1.1 Product Overview .....	1
1.2 Package Contents .....	1
1.3 Product Dimensions .....	2
1.4 Rackmount Installation.....	3
1.5 Front Panel Overview .....	5
1.6 Rear Panel Overview .....	6
1.7 Keypad Overview.....	7
1.8 Display Overview .....	8
<b>2 Getting Started.....</b>	<b>9</b>
2.1 Input Power and Fuse Requirements.....	9
2.2 Fuse Requirements.....	10
2.3 Line Voltage Selection .....	10
2.4 Output Connections .....	12
2.5 Carrying handle Adjustment .....	13
2.6 Preliminary Check.....	14
<b>3 Front Panel Operation .....</b>	<b>16</b>
3.1 Check Model and Firmware Version .....	16
3.2 Output Control .....	16
3.3 Meter Mode .....	17
3.4 Setting Voltage and Current .....	17
3.5 Over Voltage Protection (OVP).....	18
3.6 Save/Recall Instrument Settings.....	18
3.7 Key Lock.....	19
3.8 Output Check.....	19
<b>4 Menu Access and Options .....</b>	<b>21</b>
4.1 How to Access the Menu.....	21
4.2 Menu Options.....	21

4.3	Output Power-on State .....	22
4.4	Output Parameters .....	22
4.5	Lock/Unlock Rotary Knob .....	22
4.6	Buzzer On/Off .....	23
4.7	Communication .....	23
4.8	Memory Group .....	24
4.9	Protocol .....	24
4.10	Return Meter .....	24
4.11	System Menu .....	25
4.12	Combined Series and Parallel Modes .....	26
4.13	Tracking Mode .....	29
4.14	Parameters in Series/Parallel Mode .....	30
4.15	Over Temperature Protection .....	30
4.16	Remote Sense .....	30
<b>5</b>	<b>Remote Operation .....</b>	<b>32</b>
5.1	Interface Configuration .....	32
<b>6</b>	<b>Remote Commands .....</b>	<b>34</b>
<b>7</b>	<b>Troubleshooting Guide .....</b>	<b>35</b>
<b>8</b>	<b>Specifications .....</b>	<b>36</b>
<b>9</b>	<b>Calibration .....</b>	<b>37</b>
<b>10</b>	<b>SERVICE INFORMATION .....</b>	<b>38</b>
<b>11</b>	<b>LIMITED THREE-YEAR WARRANTY .....</b>	<b>38</b>

# 1 General Information

## 1.1 Product Overview

The 9130B Series programmable triple output DC power supplies feature isolated outputs that can be adjusted independently. They can be configured for series or parallel mode when connecting multiple channels together. The front panel keys and the rotary knob provide a convenient means for setting values and adjusting parameters. Built-in memory supports storing and recalling user settings without the need to connect to an external PC. A wide range of interface options enables remote controllability from a PC.

### Features:

- 3 independent, fully programmable and electrically isolated outputs
- Front and rear panel output terminals
- Remote Sense on all channels
- Display Voltage and Current of all 3 channels simultaneously
- RS232/USB/GPIB remote interfaces
- Series, parallel, and tracking modes
- Output timer function (0.1 - 99999.9 seconds)
- Store/recall up to 36 instrument settings
- Bright and easy to read display (VFD technology)
- OVP, OCP, OTP Protection
- Compact half-rack 2U form factor

## 1.2 Package Contents

Please inspect the instrument mechanically and electrically upon receiving it. Unpack all items from the shipping carton, and check for any obvious signs of physical damage that may have occurred during transportation. Report any damage to the shipping agent immediately. Save the original packing carton for possible future reshipment. Every power supply is shipped with the following contents:

- **1 x 9130B, 9131B, or 9132B Power Supply**
- **1 x User Manual**
- **1 x AC Power Cord**
- **1 x Certificate of Calibration**
- **1 x Test Report**

Verify that all items above are included in the shipping container. If anything is missing, please contact B&K Precision.

# 1.3 Product Dimensions

The 9130B power supply's dimensions are approximately 214.5 mm (8.44 in) x 88.2 mm (3.47 in) x 354.6 mm (13.96 in) (W x H x D). The 9131B and 9232B power supply's dimensions are approximately 214.5 mm (8.44 in) x 88.2 mm (3.47 in) x 445 mm (17.52 in) (W x H x D).

*Note: All dimensions in the figures below are measured in millimeters (mm).*

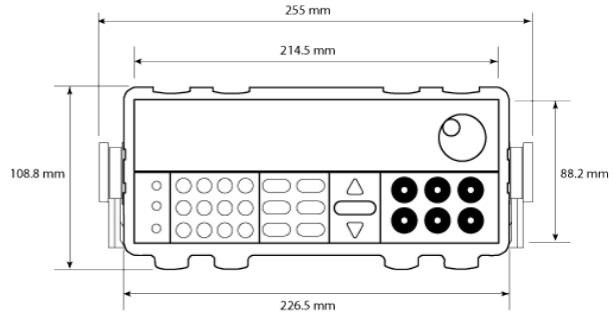
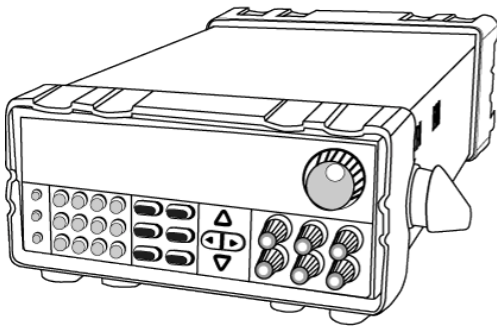

Front View of 9130B Series

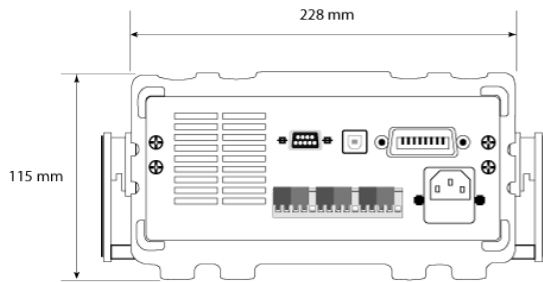

Rear View of 9130B

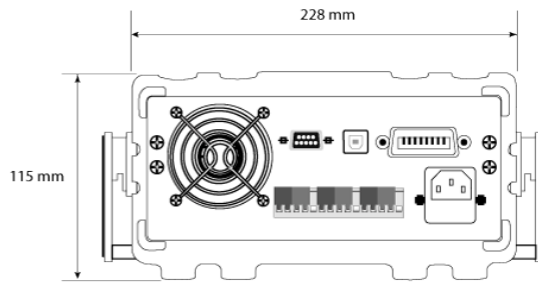

Rear View of 9131B & 9132B

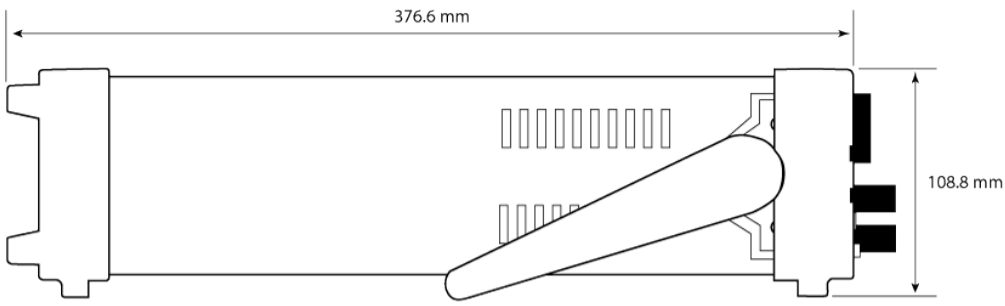

Side View of 9130B

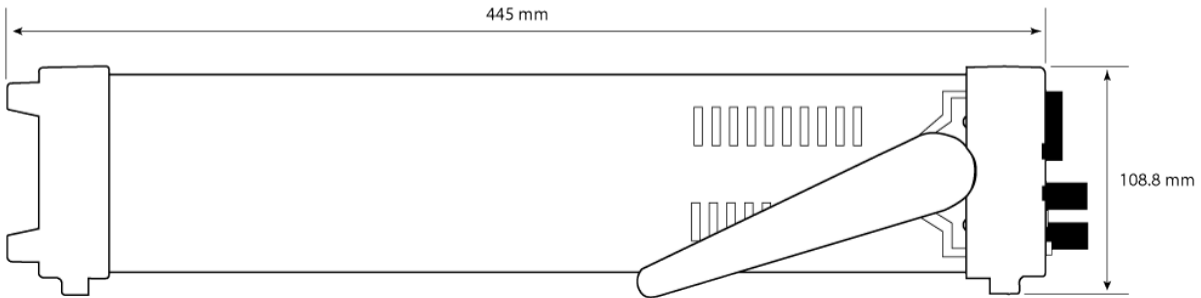

Side View of 9131B & 9132B

## 1.4 Rackmount Installation

The instrument can be installed in a standard 19-inch rack using the optional IT-E151 rackmount kit. Below is an image of a 9130B Series model installed with the IT-E151 rackmount kit.

---

**Note:** Remove the carrying handle and the two plastic ears before mounting the instrument. To remove the handle, grasp the handle by its sides, pull outwards, and rotate it until the arrow on the handle and the arrow on the plastic ears are in opposite directions. Then pull the handle outward. After removing the handle, you can use a screwdriver to remove the two plastic ears.

---

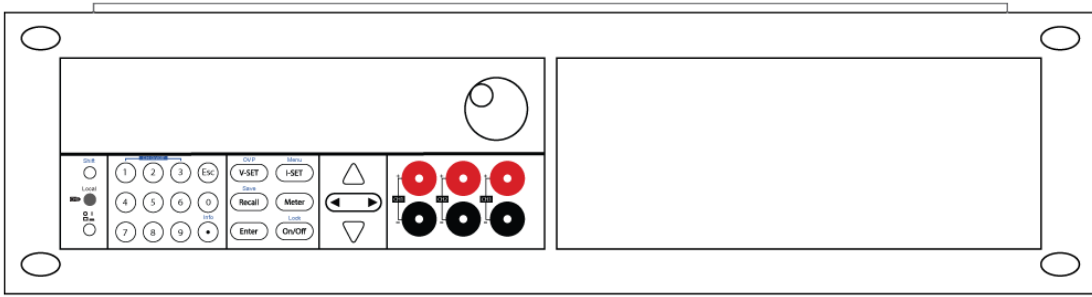

To rackmount a single instrument, order rackmount kit IT-E151

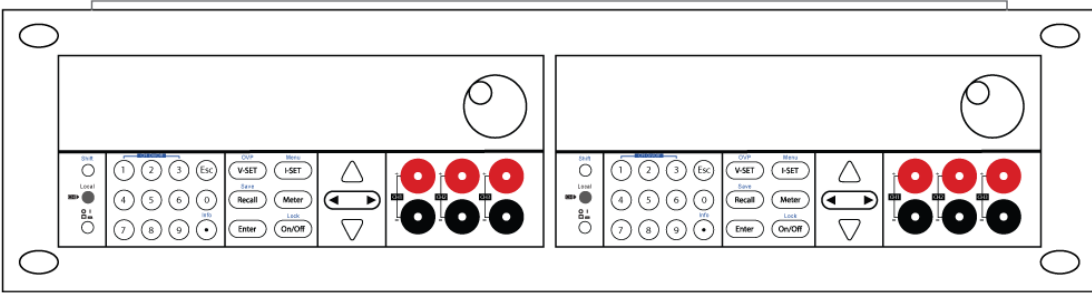

To rackmount two instruments side-by-side, order rackmount kit IT-E151 and remove the front panel cover

## 1.5 Front Panel Overview

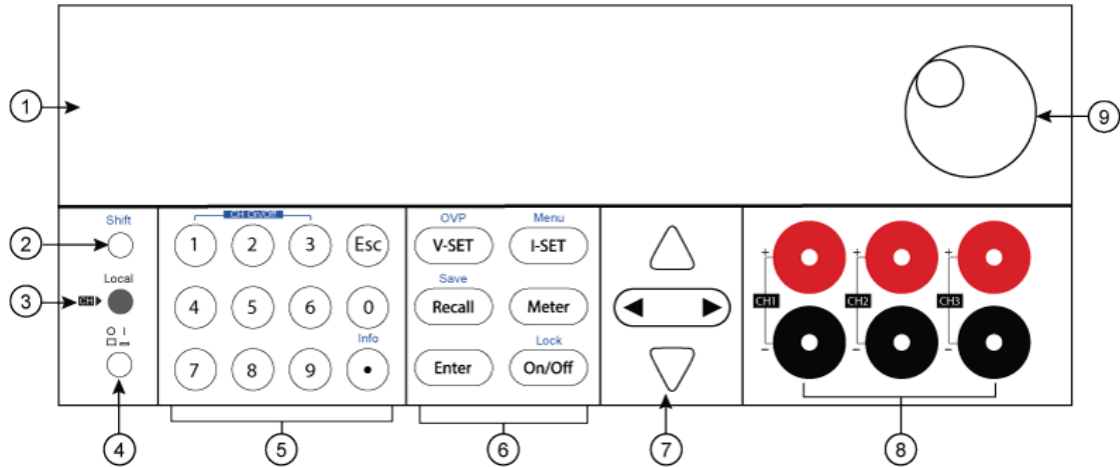

Figure 1 - Front Panel

### Front Panel Description

---

① VFD display

---

② Shift key

---

③ Local key

---

④ Power key

---

⑤ Numeric keys

---

⑥ Function keys

---

⑦ Cursor keys

---

⑧ Output terminals

---

⑨ Rotary knob

---



## 1.6 Rear Panel Overview

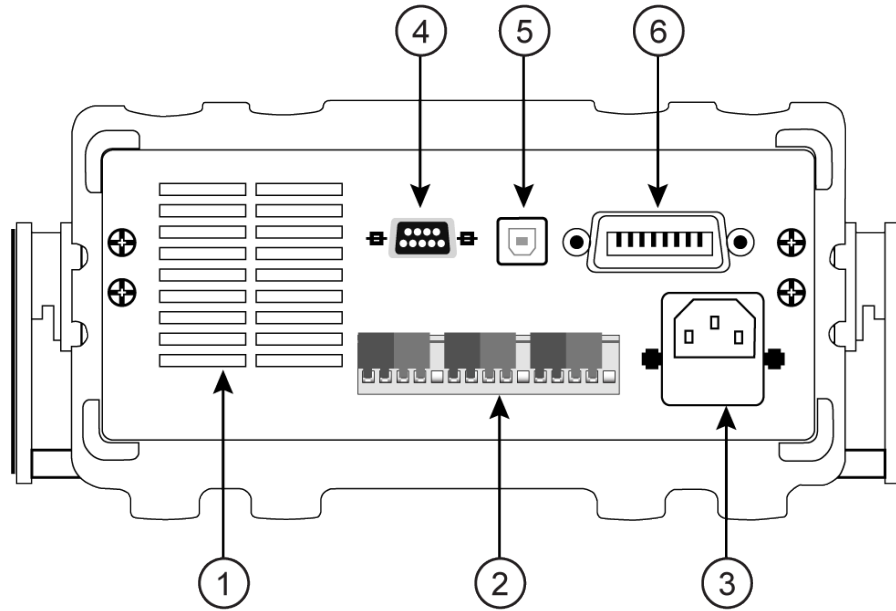

Figure 2 - Rear Panel

### Rear Panel Description

- 
- ① Cooling fan

---

  - ② Remote sense terminal

---

  - ③ AC power input receptacle & fuse box

---

  - ④ RS-232 interface

---

  - ⑤ USB interface

---

  - ⑥ GPIB interface

---

## 1.7 Keypad Overview

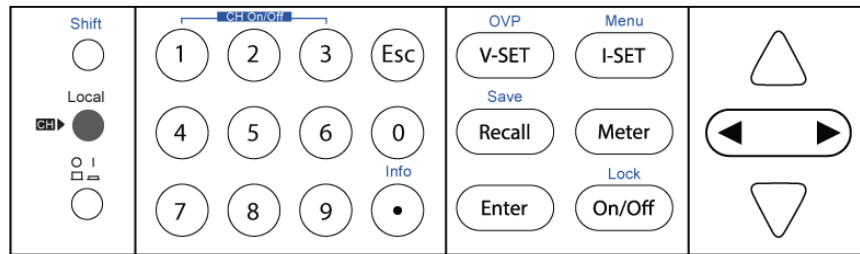

Figure 3 - Keypad

### Keypad Description

	Shift key <i>Enables access to secondary functions (Labeled in blue)</i>
	Local key <i>Sets the instrument back to local mode.</i>
	Power key <i>Power on the instrument.</i>
	Numeric keypad <i>Enters numeric values for various parameters.</i>
	V-set / OVP button <i>Configures output voltage or sets the overvoltage protection point for the power supply.</i>
	I-set / Menu button <i>Configures output current or allows access to the power supply menu settings.</i>
	Recall / Save button <i>Saves and recalls instrument settings.</i>
	Meter <i>Switches from set value display to measured output value display.</i>
	Enter <i>Confirms setting</i>
	Output / Lock button <i>Controls output On/Off state of the power supply or used to lock the front panel buttons.</i>
	Left/Right arrow keys <i>Adjusts cursor position or select menu items.</i>
	Up/Down arrow keys <i>Used to select menu items or increase/decrease output voltage or current values.</i>
	Esc key <i>Cancel and return to previous menu.</i>

## 1.8 Display Overview

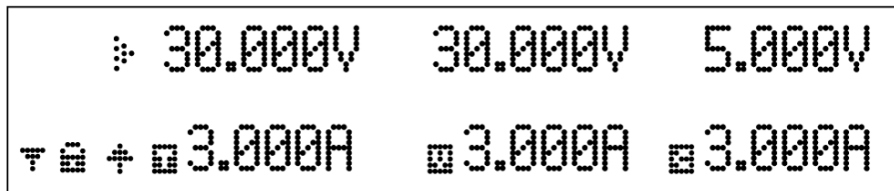









Figure 4 - Display

### Display Description

OFF	Indicates output is off
	Indicates constant voltage mode
	Indicates constant current mode
	Indicates the shift button is pressed
	Tracking mode enabled
	Indicates remote mode
	Keyboard lock enabled
	Indicates the channel currently selected

## 2 Getting Started

Before connecting and powering up the instrument, please review and go through the instructions in this chapter.

### 2.1 Input Power and Fuse Requirements

The supply has a selectable AC input that accepts line voltage input within:

Voltage: 110 V (+/- 10 %) or 220 V (+/- 10 %)

Frequency: 47 Hz – 63 Hz

Before connecting to an AC outlet or external power source, be sure that the power switch is in the OFF position and verify that the AC power cord, including the extension line, is compatible with the rated voltage/current and that there is sufficient circuit capacity for the power supply. Once verified, connect the cable firmly.

---

#### **WARNING**



The included AC power cord is safety certified for this instrument operating in rated range. To change a cable or add an extension cable, be sure that it can meet the required power ratings for this instrument. Any misuse with wrong or unsafe cables will void the warranty.

---

#### **SHOCK HAZARD:**



The power cord provides a chassis ground through a third conductor. Verify that your power outlet is of the three-conductor type with the correct pin connected to earth ground.

---

## 2.2 Fuse Requirements

An AC input fuse is necessary when powering the instrument. The below table shows the fuse required for all models operating with either 110V AC or 220V AC input.

Table 2.1 - Fuse Table

Model	Fuse Specification (110V AC)	Fuse Specification (220V AC)
9130B	6.3A 250V	3.15A 250V
9131B	10A 250V	5A 250V
9132B	10A 250V	5A 250V

## 2.3 Line Voltage Selection

The power supplies can be selected to operate with 110 V input or 220 V input. To ensure that your instrument is properly configured to operate at the desired AC line voltage, please follow the steps below:

### **!WARNING**

For safety, no power should be applied to the instrument while changing line voltage operation. Disconnect all cables connected to the instrument before proceeding.

#### Step 1 - Check and/or Change Fuse

- Locate the fuse box next to the AC input connector in the rear panel (see Figure 2)
- With a small flat blade screwdriver, insert into the fuse box slit to pull and slide out the fuse box as indicated below.
- Check and replace fuse (if necessary) for the desired line voltage operation (see Table 1 - Fuse Table).

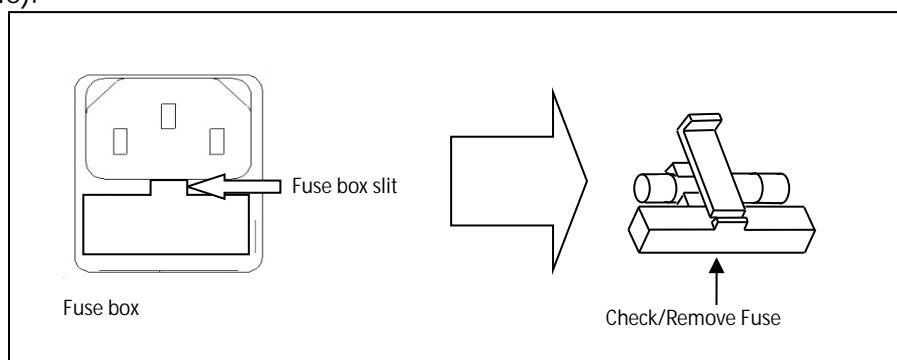

Figure 5 - Fuse replacement

## Step 2 - Check and/or Change Line Voltage Switch

- Locate the Line Voltage Switch, which has markings that indicate “110” for 110V or “220” for 220V line operation. Depending on the model, the Line Voltage Switch will be located either on the rear or bottom of the instrument. Set the switch to the desired line voltage operation.

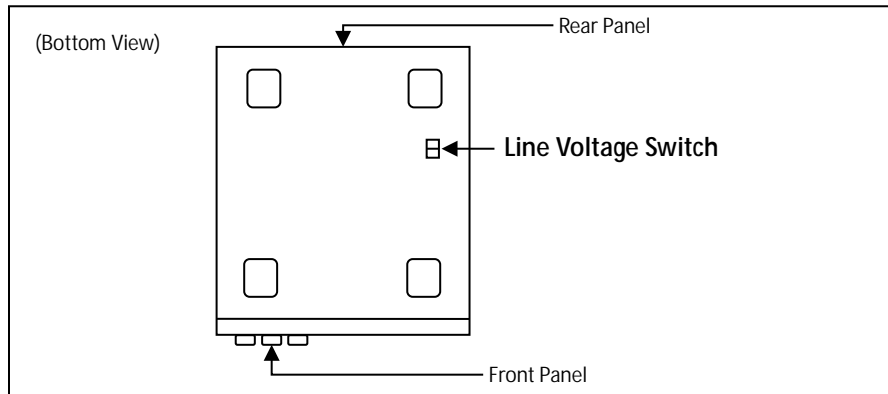

Figure 6 - Line Voltage Switch Location

---

### **⚠ WARNING**

Do not connect power to the instrument until the line voltage selection is setup correctly. Applying an incorrect line voltage or configuring the line voltage selection improperly may damage the instrument and void all warranty.

---

### **⚠ WARNING**

Any disassembling of the case or changing the fuse not performed by an authorized service technician will void the warranty of the instrument.

---

## 2.4 Output Connections

The main DC output terminal is a binding post terminal on the front panel.

---

**⚠ WARNING**

Before connecting wires to the output terminals, turn OFF the power supply to avoid damage to the instrument and the device under test (DUT). For safety, load wires must have a wire gauge size large enough to prevent overheating when the power supply operates at maximum short circuit output current. It will also prevent large voltage drops from resistances in the wires.

---

**SHOCK HAZARD:**



Hazardous voltages may exist at the outputs and the load connections when using a power supply with a rated output greater than 40V. To protect personnel against accidental contact with hazardous voltages, ensure that the load and its connections have no accessible live parts. Ensure that the load wiring insulation rating is greater than to the maximum output voltage of the power supply.

---

## 2.5 Carrying handle Adjustment

To adjust the position, grasp the handle by the sides and pull outward. Then rotate the handle to the desired position.

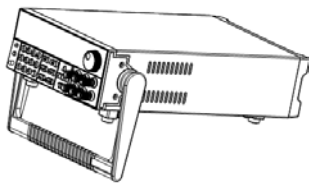
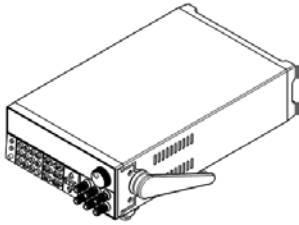

Bench operation



Handle transport position

Figure 7 - Carrying Handle

---

### **⚠ WARNING**

Be sure the handle is locked in position and avoid twisting movements while transporting as the handle can damage and drop the power supply.

---



## 2.6 Preliminary Check

Complete the following steps to verify that the power supply is ready for use.

1. **Verify AC Input Voltage**

Verify and check to make sure proper AC voltages are available to power the instrument. The AC voltage range must meet the acceptable specification as explained in "2.1 Input Power and Fuse Requirements".

2. **Connect Power and Self-Test**

Connect AC power cord to the AC receptacle in the rear panel and press the power switch to the  ON position to turn ON the instrument. It will run through a self-test procedure.

After power on, during the self-test, the following should be displayed on the VFD:

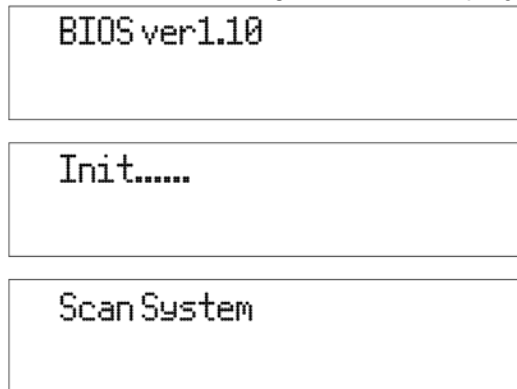

Figure 7 - Scan System

After the Scan System is complete the VFD will display as shown in Figure 9.

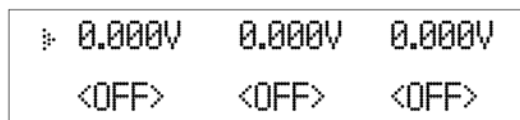

Figure 9 - Scan Complete

---

**Note:** The initial power on state is based on the settings in the (Config) configuration menu.

---

### Self-test Errors

The following errors will be displayed if the self-test did not complete successfully:



Error Message on Display	Description
EEPROM Fail	The internal EEPROM is corrupted or damaged.
System Lost	Last system settings within the EEPROM are lost.
Model Fail	Channel response failure.
Cal Lost	Calibration data within the EEPROM is lost.
Fact Loss	Factory calibration data is lost.
Model Lost	Channel initialization failed.

If any of these errors occur, please contact B&K Precision.

# 3 Front Panel Operation

At power-on, the power supply will automatically enter the front-panel operation mode and the instrument can be controlled via the front panel keys and knob.



The power supply enters remote mode as soon as a valid remote command is received via the selected communication interface in the rear panel. The VFD also displays a "☒" symbol in the lower left to indicate remote mode. Switching to remote mode does not impact the supply's output parameters. In remote mode, front-panel operation is disabled. Only Meter and Local

buttons are enabled. If the power supply is in remote mode and the  key is enabled, you can revert to manual mode by pressing the  key.

The power supply is in Meter mode when it is powered on. In this mode, the VFD will display the output voltage and current.



The output of the power supply can be enabled/disabled from the front panel by pressing the  button. When output is enabled, the supply will display the state and voltage/current of each channel. "☒" represents constant current mode. "☒" represents constant voltage mode. This is indicated for each channel independently. When output is disabled, the VFD will display <OFF> for each channel if the supply is in Meter mode. If the supply is not in Meter mode, I-SET current settings of each channel will be displayed.

## 3.1 Check Model and Firmware Version



The firmware version, model, and serial number can be verified by pressing the  followed by . This information can also be acquired by using the \*IDN? remote command via any of the remote interfaces connected to a computer.

## 3.2 Output Control



Pressing the  button toggles the output state of all 3 channels of the power supply.













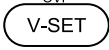
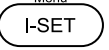



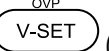

To control the output state of each channel individually, press  1,  2, or  3 for channels 1, 2, or 3 respectively.

### 3.3 Meter Mode

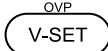
The power supply can display the set voltage and current values or the measured voltage and current readings. Press the  button to toggle between displaying settings and measured readings. When the  button is illuminated, the display shows the measured voltage and current readings. When it is not illuminated, the display shows the set voltage and current values.

### 3.4 Setting Voltage and Current



Follow the steps below to set the output voltage or current. The values can be entered using the numeric keypad, rotary knob or the Up/Down arrow keys  .

- Using the keypad:** Press   key to select channel (selected channel is indicated by ) , press  (for voltage) or  (for current) and the button will illuminate. Then enter a numerical value on the keypad followed by .
- Using the rotary knob:** Press   key to select channel (selected channel is indicated by ) , press  (for voltage) or  (for current), then press   to move the cursor position and adjust the voltage or current value using the rotary knob.
- Using the Up/Down arrows:** Press   key to select channel (selected channel is indicated by ) , press  (for voltage) or  (for current), then press   to move the cursor position and adjust the voltage or current value using  .

---







Note: To see the voltage and current setting changes, make sure the instrument is not displaying in meter mode (  button is not illuminated in this mode). See 4.10 Return Meter for more information on this mode.

---

When output is ON, the user can use the rotary knob to adjust the voltage value when the output is in constant voltage  mode. The same can be done to adjust the current value when output is in constant current  mode.

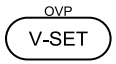
## 3.5 Over Voltage Protection (OVP)

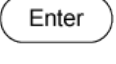
Over voltage protection can be set for each channel. Follow the steps below.

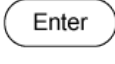
1. Press  key to select the channel.
2. Press  followed by the  button. The display will show **OVP Set** and **OFF ON** options below.
3. Use the  keys to select **OFF** or **ON** to disable or enable OVP for the selected channel.
4. Press  and the display below **OVP Set** will indicate the OVP voltage limit.
5. Use the numeric keypad, rotary knob or the Up/Down arrow keys  to change the desired voltage limit, then press  to confirm the changes.
6. Repeat the above steps for setting each channel.

When OVP protection is tripped during operation, the output will turn off and the power supply will display **OVER VOLT**. To clear the trip status, press any key once.

---



Note: Avoid exceeding 120% of the rated voltage across the output terminals or it will damage the power supply.

---

## 3.6 Save/Recall Instrument Settings

Up to 36 instrument settings can be saved/recalled from the instrument's internal memory. The settings that can be saved/recalled are set voltage, set current, OVP settings, and maximum voltage limit settings.

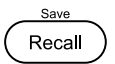
### Save Settings

1. Configure the settings you want to save and press  key and  button to enter **Save** mode.
2. The  button will flash on and off until a Save location value is entered.
3. Use the numeric keypad to enter the memory location between **1** and **9**. Once the location number is entered, the power supply will display **Save Data Done!** and return to normal operation.
4. To save more than 9 settings, refer to "4.8 Memory Group".
5. To exit **Save** mode at any time, press  key.

### Recall Settings

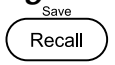
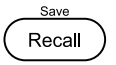
1. Press  button to enter **Recall** mode. The  button will be illuminated.
2. Use the numeric keypad to enter the memory location between **1** through **9** to recall

saved settings from that location. If the selected memory location does not have any saved settings, the message **Recall Data Empty!** will be displayed.

---







Note: When in Recall mode, users can recall settings from different locations without having to press additional keys each time. For example, you can press 1 to recall settings in location 1, and then press 5 to immediately recall settings in location 5.

---

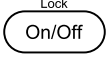
3. To exit **Recall** mode at any time, press the  button again or press .

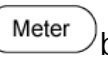
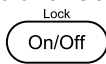
## 3.7 Key Lock

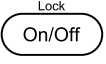
The front panel keys can be locked to prevent unwanted changes to output settings and power supply configurations. Follow the steps below to enable/disable key lock.

1. Press the  key and the  button. A **Lock**  indicator will light up on the display, indicating that the front panel keys are locked. At this point, all keys are disabled except for the  key,  button and  button.
2. To unlock the keys, press the  key and  button again. The **Lock**  indicator will disappear and all keys will be enabled.

## 3.8 Output Check

### *Voltage Check*

Follow the steps below to check the voltage output with no load connected.

1. Turn on the power supply. The display should look like the following.

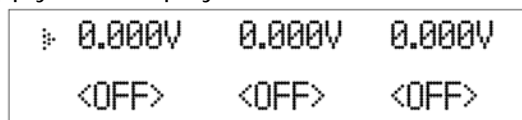
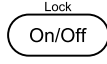

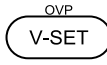

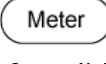

Figure 10 - Voltage Check

2. Enable the output by pressing ; the button will illuminate. The **<OFF>** will be replaced with a numeric value and a  next to this value for each channel.
3. Press the  button if it is illuminated to enter the settings mode.
4. Press  first, and then a numeric value on the keypad and then press the  button.

---





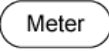

Note: The  button will automatically return to meter mode and illuminate after 5 seconds of a valid entry (see 4.10 Return Meter to disable this).

---

5. If the  button is not already illuminated, press it once and the display will show the measured voltage at the output. This voltage may fluctuate slightly from the voltage value entered in the previous steps.
6. (Optional) You may also verify the output voltage by connecting the (+) and (-) terminals to an external voltmeter. The measured value should match or be comparable to the entered voltage value.
7. Verify channels 2 and 3 according to steps 1 through 6.

### **Current Check**

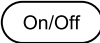





Follow the steps below to check current output of the power supply.

1. Turn off all output channels ( not illuminated). The display will show the <OFF> annunciator for all channels on the display.
2. Short the (+) and (-) output terminals for CH1 with test leads or a shorting bar.
3. Set the power supply to settings mode (press  so that it is not illuminated).
4. Press the  button first and then enter the value (i.e. 1.000 A) on the keypad and press the  button. The current display will now show the value you entered.
5. Enable the output by pressing the  button. The <OFF> annunciator will be replaced with a  next to the value entered indicating the power supply is in constant current mode. This numeric value may fluctuate slightly from the current value entered in step 4.
6. (Optional) You may also verify the output current by connecting the (+) and (-) terminals to an external current meter capable of measuring the current that you set. The measured value should match or be comparable to the entered current value.
7. Verify channels 2 and 3 according to steps 1 through 6.
8. Press the power switch to turn off the power supply and remove the short on the output terminals.

# 4 Menu Access and Options

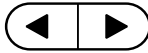
## 4.1 How to Access the Menu

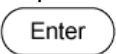
Before using the instrument, it is important to be familiarized with its menu structure and learn how to view or change settings and parameters. Follow the steps below to guide you in selecting the menu options.

1. From the normal display, press the  key and the  button to enter the menu.
2. Use the  keys or encoder knob to move through the menu selections.
3. When the selected item is blinking, press the  button to access its menu settings. There may be parameters or options to select within each menu item. Follow the same instructions as described in the previous steps to select them.
4. To save changes to a setting, press the  button.  
To exit the menu at any time, press the  key multiple times. Each press exits out of a submenu.

## 4.2 Menu Options

All settings and parameters can be configured from the built-in menu system of the power supply. The menu system is divided into the following sections as displayed on the power supply.

### Config

<b>OutState</b>	Set the output state during power-on.
<b>OutParam</b>	Set the power-on parameters
<b>Knob</b>	Lock/unlock the rotary knob
<b>Buzzer</b>	Enable/disable instrument beeper
<b>Communication</b>	Select and configure RS232, GPIB, and USB interfaces
<b>MemoryGroup</b>	Select memory group
<b>Protocol</b>	Select SCPI options
<b>ReturnMeter</b>	Enable automatic return state
<b>Reset</b>	Reset menu
<b>Exit</b>	Move up menu structure

### System



<b>CH1</b>	Configure channel 1
------------	---------------------



	CH2	Configure channel 2
	CH3	Configure channel 3
Comb	Off	Turns off series, parallel, or tracking mode
	Series	Configure series mode
	Para	Configure parallel mode
	Track	Configure tracking mode
Exit		Move up menu structure

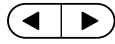

### 4.3 Output Power-on State

The initial power-on state of the power supply outputs can be configured.

1. From the **Config** menu, select **OutState** and press the  button.
2. There are two options that can be selected using the  keys or rotary knob:
3. **OFF** – Default output state.
4. **Last** – Last output state during the last power-off.
5. Select **OFF** or **Last** and press the  button.
6. To exit the menu at any time, press  twice.

### 4.4 Output Parameters

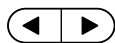
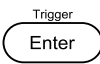
This option sets the voltage and current output state values at power-on.

1. From the **Config** menu, select **OutParam** and press the  button.
2. There are two options that can be selected using the  cursor keys or rotary knob:
3. **Reset** – Restores the default voltage, current, and output states based on factory default parameters.  
**Keep** – Restores the voltage, current, and output states for each channel based on the settings during last power-off.
4. Select the desired settings for power-on, and press the  button to save changes.
5. To exit the menu at any time, press the  key twice.

### 4.5 Lock/Unlock Rotary Knob

This option enables or disables the rotary knob.

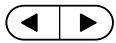



1. From the **Config** menu, select **Knob** and press the  button.
2. There are two options that can be selected by using the  keys or rotary knob:  
**Unlock** – Enable rotary knob

**Lock** – Disable rotary knob

3. To exit the menu at any time, press the  key twice.

## 4.6 Buzzer On/Off









This option enables or disables the instrument beeper.

1. From the **Config** menu, select **Buzzer** and press the  button.
2. There are two options that can be selected by using the  keys or rotary knob:
3. Select one of two options below, then press the  button:  
**OFF** – Beep is turned off.  
**ON** – Beep is turned on.
4. To exit the menu at any time, press the  key twice.

## 4.7 Communication



Follow the instructions below to select and configure the remote interface.

### RS232





1. From the **Config** menu, select **RS-232** and press the  button. This will select the RS-232 interface for remote communication.
2. There are four options that can be selected by using the  keys or rotary knob:
3. Use the  to select the Baud Rate – **4800, 9600, 19200, 38400, 57600** or **115200** and press  button.
4. Use the  keys to select the Parity – **N** None, **O** Odd, or **E** Even and press the  button.
5. Use the  to select the Control Flow – **Single** or **Mux** and press the  button.
6. To exit the menu at any time, press the  key twice.

*Factory default: 4800,8,N,1, Single*

### USB

1. From the **Config** menu, select **USB** and press the  button. This will select the USB interface for remote communication.
2. To exit the menu at any time, press the  key twice.



## GPIB

1. From the **Config** menu, select **GPIB** and press the  button. This will select the GPIB interface for remote communication.
2. Use the   keys to select Address 1-31 and press the  button.
3. To exit the menu at any time, press the  key twice.

## 4.8 Memory Group

Up to 36 instrument settings can be stored into the instrument's non-volatile memory. The internal memory bank is divided into four groups. They are Grp1, Grp2, Grp3 and Grp4. Each group can save 9 different operating states (1-9).

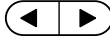

From the Config menu, select **MemoryGroup** and press the  button.

Use the   keys or rotary knob to select one of the four groups – Grp1, Grp2, Grp3, or Grp4 and press the  button.

To save the first 9 instrument settings, select **Grp 1**, then exit the menu and follow the instructions in section “3.6 Save/Recall Instrument Settings” to save and recall settings. To save additional settings, select **Grp 2, Grp3, or Grp4**, then follow the same steps in section 3.6.

## 4.9 Protocol

From the **Config** menu, select **Protocol** and press the  button.

There are three options: **DEFAULT**, **EXT1**, **LEGACY**. Select one of the options by using the   keys or rotary knob and press the  button. The **DEFAULT** option is recommended for most applications. The **LEGACY** option supports compatibility with B&K Precision 9130.

**Note: EXT1 is not used.**

## 4.10 Return Meter

This option allows users to enable an internal fixed timer delay (5 seconds) for the power supply to automatically switch from settings mode to meter mode. When enabled, it will automatically switch to meter mode after 5 seconds. The backlight of the  button will

illuminate. In this state, pushing the button again to toggle back to settings mode will reset the 5-second timer again before the supply changes back to meter mode.

From the **Config** menu, select **ReturnMeter** and press the  button.

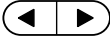
1. There are two options that can be selected by using the  keys or rotary knob.



Select **OFF** or **Wait5Sec** and press the  button.

## Reset

**Note: Restoring the instrument to default values will change all current instrument settings and parameters back to their default values.**

All instrument settings can be reset back to their factory default values by doing the following:

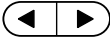
From the **Config** menu, select **Reset** and press the  button.

1. There are two options that can be selected by using the  keys or rotary knob, select **NO** to exit or **YES** to proceed and press the  button.



## Exit

This option will exit the **Systems** menu and return to the **Power Menu...**

From the **Config** menu level, select **Exit** and press the  button.

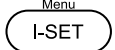

## 4.11 System Menu

The system menu allows configuration of each channel's maximum voltage limit and their output timer.

To access this menu, press  key and then press the  button. Use the  keys to select **CH1**, **CH2** or **CH3** and press the  button.

Use the  keys to select **MaxVolt**, **OutTimer** or **Exit**, and then press the  button.

### MaxVolt

This allows the user to set the maximum voltage that can be entered from the front panel to avoid accidental damage to DUT (Device under test) connected to the power supply. The maximum voltage can be entered using the numeric keypad, rotary knob or the Up/Down arrow   keys.

### OutTimer

This option will configure the internal output timer of the selected channel. The timer can be set from 0.1 to 99999.9 seconds for each output. This will configure the power supply to enable the output for the specified period of time. This value can be set using the numeric keypad, rotary knob or the Up/Down arrow  $\triangle$   $\nabla$  keys.

### Exit

This option will exit the **System** menu and return to the **Power Menu....**

From the **System** menu level, select **Exit** and press the  button.

## 4.12 Combined Series and Parallel Modes

This section describes how to configure the power supply for series and parallel modes.

From the **Power Menu....** Select **Comb** followed by the  button. The display will show four menu options **OFF Series Para Track**. Each of these options are described below.

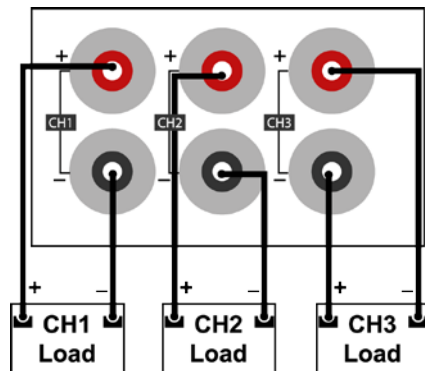



Figure 8 – Normal Wiring

### OFF

This option is used to disable series, parallel, or tracking modes.

1. From the **Power Combine Set...** menu select **OFF** and press the  button.
2. The power supply will momentarily display **Remove Successful!** Before returning to normal display.

### Series Mode

The series mode doubles the available voltage range that can be supplied by combining the voltage of channels 1 and 2. The following steps will describe the external wiring and instrument setup required to use this feature.

1. Power down the unit and remove all wiring from the output terminals.
2. Verify all wiring is connected as illustrated below:

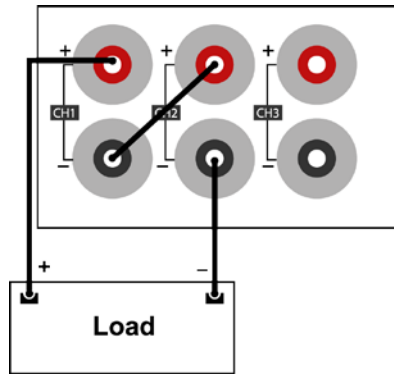

Figure 9 - Series Mode Wiring Diagram

3. Power on the unit and verify that the outputs are disabled (On/Off <sup>Lock</sup> On/Off button is not illuminated).
4. From the **Power Combine Set...** menu, select **Series** and press the **Enter** button.
5. As **CH1+Ch2** is blinking, press the **Enter** button. The power supply will display **Series Successful!** The display should look like the one shown below. **Series** and **CH1+2** will be shown in the middle of the display.

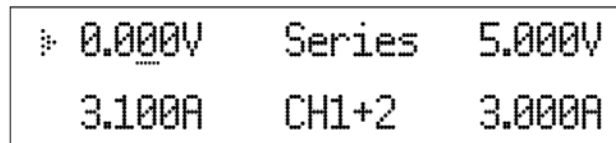

Figure 10 - Display Series CH1+2

6. Set the voltage and current for CH1+2 and CH3.
7. Enable the outputs by pressing the <sup>Lock</sup> On/Off button.
8. If the **Meter** button is not illuminated, press the **Meter** button once to display the measured voltage and current at the output.

### Para (Parallel Mode)

The Parallel mode will increase the available current range that can be supplied by combining channels 1 and 2, 2 and 3, or All. The following steps will describe the external wiring and menu options for combining channels CH1+CH2.

1. Power down the unit and remove all wiring from the output terminals.

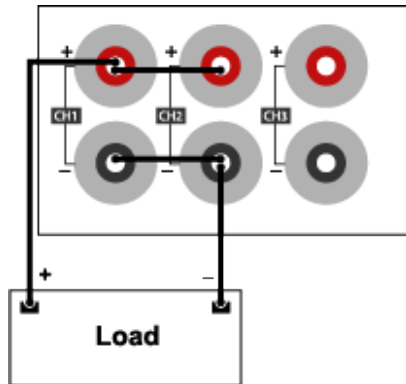

Figure 11 – Parallel Mode Wiring Diagram

2. Verify all wiring is connected as illustrated.
3. Power on the unit and verify that the outputs are turned off the On/Off <sup>Lock</sup> button is not illuminated.
4. From the **Power Combine Set...** menu select **Para** and press the <sup>Enter</sup> button.
5. The following options are available: **CH1+CH2**, **CH1+CH3** or **ALL**.
6. Select **CH1+CH2** and press the <sup>Enter</sup> button. The power supply will display **Parallel Successful!**

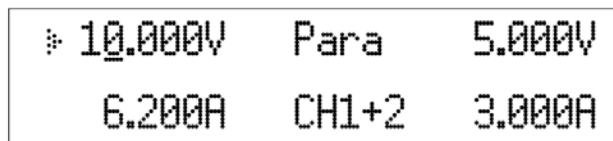

Figure 12 - CH1+CH2 Parallel Display

7. Set the voltage and current (max current will be the sum of the combined channels).
8. Enable the outputs by pressing the enter <sup>Lock</sup> On/Off button, which will illuminate.
9. If the <sup>Meter</sup> button is not illuminated, press the <sup>Meter</sup> button once to enable the measured voltage and current at the output.

**Note:** For combining CH1+CH3 follow the same steps and select CH1+CH3 for the option in step 5.

### Parallel ALL Mode

The following steps will describe the external wiring and menu options for combining ALL channels.

1. Power down the unit and remove all wiring from the output terminals.

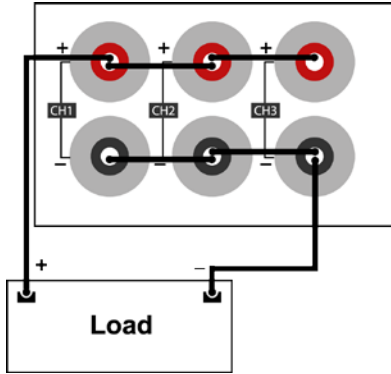

Figure 13 – Parallel Mode Wiring for All Channels

2. Verify all wiring is connected as illustrated.
3. Power on the unit and verify that the outputs are turned off (On/Off <sup>Lock</sup> On/Off button not illuminated).
4. From the **Power Combine Set...** menu, select **Para** and press the **Enter** button.
5. The following options are available: **CH1+CH2**, **CH1+CH3** or **ALL**.
6. Select **ALL** and press the **Enter** button. The power supply will display **Parallel Successful!**

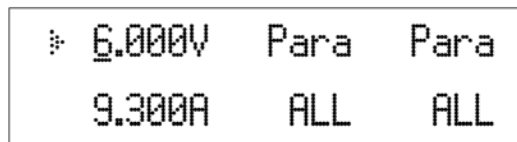



Figure 14 - All Channels Parallel Display

## 4.13 Tracking Mode

This function configures the channels for tracking mode. In tracking mode, when a voltage or current parameter is changed, channels change according to the ratio between channels.

1. From the **Power Combine Set...** menu, select **Track** and press the **Enter** button.
2. Select one of the following: **CH1+CH2**, **CH1+CH3** or **ALL**. Then, press the **Enter** button.

The power supply will display **Track Set Successful!** The  symbol will appear on the display to indicate tracking is enabled.



---

**Note:** Set the intended ratio before enabling tracking. The tracking is based on a ratio between CH1 and CH2 when the tracking is enabled. If the voltage is the same on both channels when set, the two channels will track together based on a 1 to 1 ratio. For example, if CH1 = 1 V and CH2 = 2 V a 1 to 2 ratio is set when tracking is enabled. With this ratio, a voltage increase on CH1 from 1 to 2 volts will result in 4 volts on CH2.

Tracking function is disabled if 0 V or 0 A is set when tracking is enabled.

---

## 4.14 Parameters in Series/Parallel Mode

### Maximum voltage

When operating in Series mode, voltages between channels add. In Parallel mode, the voltage equals the maximum voltage of the lowest voltage channel.

Table 4.1 - Maximum Voltage in Series/Parallel Modes

Model	9130B	9131B	9132B
Series CH1+CH2 Max Voltage	62 V	62 V	122 V
Parallel CH1+CH2 Max Voltage	31 V	31 V	62 V
Parallel CH2+CH3 Max Voltage	6 V	6 V	6 V
Parallel CH1+CH2+CH3 (All) Max Voltage	6 V	6 V	6 V

## 4.15 Over Temperature Protection

If the internal temperature of the power supply exceeds 176°F (80°C), the instrument will protect itself by automatically turn the output off. When this happens, the instrument beeper will turn on and the display will indicate **Over Temp**. It is recommended that the power supply be disconnected from the DUT and powered off to allow the supply to cool down to normal operating temperature.

## 4.16 Remote Sense

Remote sense can be used to compensate for voltage drops (up to 1 V) due to resistance from test leads connected to your device under test (DUT), thus providing more accurate output voltage. The power supply is initially set up to local sense mode by default. Refer to the following sections for details of local and remote sense setup.

### Local Sense

By default, the power supply is set up for local sense with jumpers installed. This is determined

by the wire connections in the rear panel as shown below.

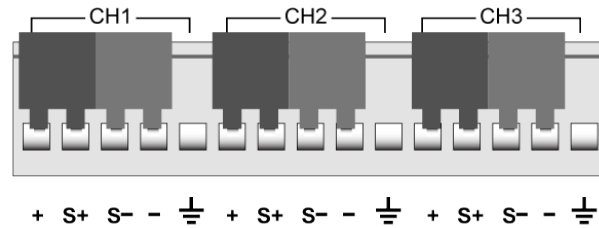

Figure 15 - Jumpers installed for local sense

---

**⚠ WARNING**

DO NOT disconnect the jumpers if remote sense is not used. Doing so will cause erratic behavior and may damage the power supply under certain conditions.



Never connect any power source into any of the terminals at any time during operation.

When output is enabled, DO NOT use your hands to touch the terminals or the screws that are designed to tighten wires to the terminals. Doing so may create a shock hazard under high voltage output conditions.

---

### Remote Sense

To enable remote sense, follow the steps below for each channel:

1. Power OFF the supply and disconnect all loads and cables connected to it.
2. Use a small flat blade screwdriver to loosen and remove the jumper wires as shown below.

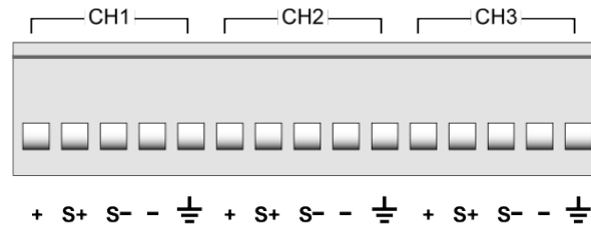

Figure 16 - Sense jumpers removed

1. Connect wires to the DUT as illustrated in Figure 20. Make the connections between + and S+ and S- and - for each channel that will be using remote sense. The S+ and S- wires should be twisted as illustrated to minimize noise.

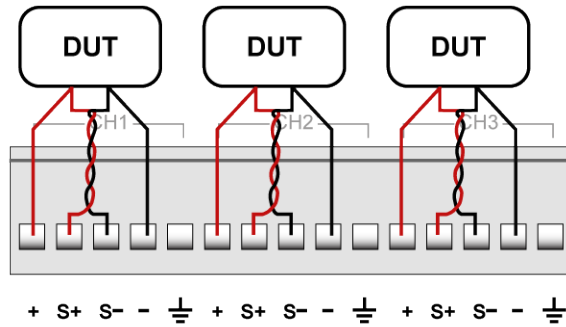

Figure 17 - Remote sense connections



2. Connect the S+ to the Device Under Test (DUT)'s positive (+) terminal, and connect the S- to the DUT's negative (-) terminal.
3. Double check that the connections matches to Figure 20.
4. Power ON the supply and then configure and enable the output.

### **CAUTION**

DO NOT at any time disconnect the wires from the S+ and S- terminals to the DUT while output is enabled (ON). Doing so may damage the power supply and cause unstable output.

## 5 Remote Operation

The power supply comes standard with RS232, USB, and GPIB remote interfaces. Users can program the power supply by using SCPI (Standard Commands for Programmable Instruments) commands over any one of the remote interfaces. This section will describe how to set up all of the supported interfaces.

**Note:** The  indicator will appear on display when the power supply is successfully connected to a PC remotely through any remote interface. Keys on the front panel will be locked until the instrument is in LOCAL mode. To return to LOCAL mode from the front panel, press . The  indicator will disappear when the instrument is in LOCAL mode.

### 5.1 Interface Configuration

#### **RS-232**

For RS-232 connectivity, refer to the diagram below for pin out information. The RS-232 is labeled in the rear panel and it is a female DB-9 interface.

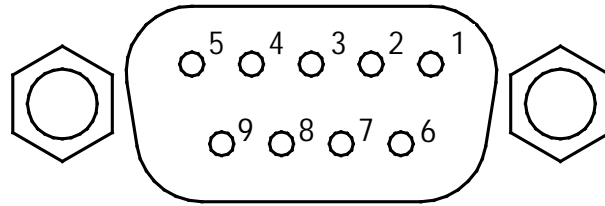

PIN	Description
1	-
2	Transmit Data
3	Receive Data
4	-
5	GND
6	-
7	-
8	-
9	-

Figure 18 - RS-232 Pin out

A straight pin-to-pin DB9 female to DB9 male serial cable is required for using the RS-232 interface. Do not use a null modem or crossover DB9 serial cable.

Follow the steps below to configure the power supply for RS-232 operation:

1. From the **Config** menu, select **Communication** and press the **Enter** button.
2. Press the **◀▶** keys until **RS-232** is blinking and press the **Enter** button.  
The configurable options are:  
**Baud rate:** 9600 (default), 19200, 38400, 57600, 115200.  
**Parity/data bits:** None/8 bits (default), Even/8 bits, Odd/8 bits.  
**Address:** Single, Mux
3. Use the **◀▶** keys to select the option and the **△▽** keys to change settings. When all three options are set press the **Enter** button.
4. If MUX mode has been selected specify the ADDR using the keypad or **△▽** and press the **Enter** button.

---

**Note:** The RS-232 interface does not have a flow control mechanism. The programmer should be aware of this limitation and allow sufficient command process time. If the remote commands are sent too fast the power supply's internal buffer may overrun and cause a communication error. Therefore, adding a delay between commands to allow for sufficient time to process commands is required.



---

5. All serial settings must match the settings configured on the PC in order for

communication to link successfully.

## USB

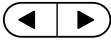
All models include a USBTMC-compliant interface that can be used for remote communication. There are no settings in the menu system for USB configuration. The only requirement is a USBTMC driver. We recommend using the drivers provided by National Instruments, which come included with NI-VISA and can be downloaded here: <http://www.ni.com/visa>





1. From the **Config** menu, select **Communication** then press .
2. Use the  keys to select the **USB** option then press . No other options are required.

## GPIB

Each model can be configured with a GPIB address from 1-31. To communicate via GPIB, connect a GPIB cable to the GPIB interface on the rear panel, as illustrated below.

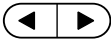

Follow the instructions below to select and configure the GPIB interface for remote operation.

1. From the **Config** menu, select **Communication** then press .
2. Use the  keys to select the **GPIB** option then press .
3. Configure the GPIB **Communication Address** to which the power supply will be assigned. Use the rotary numeric keypad  keys or rotary knob to enter an **Address** value from 1-31 then press .
4. Make sure the address assigned to the power supply unit matches the address the data commands are being sent to.

## 6 Remote Commands

The instrument supports some SCPI commands and some instrument specific commands. These commands enable a computer to remotely communicate and control the instrument over any of the supported remote interfaces: USBTMC, RS-232, and GPIB.

Refer to the programming manual for details, which can be downloaded from [www.bkprecision.com](http://www.bkprecision.com).

# 7 Troubleshooting Guide

Below are some frequently asked questions and answers. Please check if any apply to your power supply before contacting B&K Precision.

## General

### **Q: I cannot power up the power supply.**

- Check that the power cord is securely connected to the AC input and there is live power from your electrical AC outlet.
- Verify that the AC power coming from the mains contains the correct voltage. The power supply can accept a specific range of AC input voltages. Refer to section 2.1.

### **Q: How do I set up the supply to run in constant current mode?**

- The supply is a CV/CC power supply that automatically crosses over from CV to CC upon a load, which draws current at the current limit (ISET). Therefore, it is dependent on the load. For example, if ISET is configured as 1 A, the load must draw 1 A before the supply will go into CC mode.

### **Q: How come my display voltage is lower than the voltage I set?**

- This is often because of the resistances from the test leads/wires connected between the supply and the DUT (device under test), which causes a drop in voltage. To minimize this drop, use remote sense terminals to compensate and output a more accurate voltage to the DUT.

### **Q: I cannot set voltage at the maximum rating.**

- This may be that the set voltage is outside of the voltage maximum limit. Refer to the MaxVolt section of the manual and set this value above the voltage that is being entered. This can also be set to the limit of the power supplies range, which in effect turns off the MaxVolt function.

## Remote Control

### **Q: I am trying to send the commands over RS232, but it does not seem to respond.**

- Check that you are sending ASCII strings that are terminated with a CR (carriage return) and LF (linefeed) character.
- For RS-232, check that the baud rate, parity, data bits, stop bit, and flow control settings match with the settings configured on both the software interface and the power supply

## 8 Specifications

**Note:** All specifications apply to the unit after a temperature stabilization time of 15 minutes over an ambient temperature range of  $23\text{ }^{\circ}\text{C} \pm 5\text{ }^{\circ}\text{C}$ . Specifications are subject to change without notice.

### Environmental Conditions:

This power supply is designed for indoor use and operation with maximum relative humidity of 80%.

Model	9130B	9131B	9132B
<b>Output Rating</b>			
Voltage	0-30 V (Ch 1 and Ch2), 0-5 V (Ch3)	0-30 V (Ch 1 and Ch2), 0-5 V (Ch3)	0-60 V (Ch 1 and Ch2), 0-5 V (Ch3)
Current	0-3 A (Ch 1 and Ch2), 0-3 A (Ch3)	0-6 A (Ch 1 and Ch2), 0-3 A (Ch3)	0-3 A (Ch 1 and Ch2), 0-3 A (Ch3)
Power	195 W	375 W	375 W
<b>Line Regulation</b>			
Voltage	$\leq 0.01\% + 3\text{ mV}$	$\leq 0.01\% + 3\text{ mV}$	$\leq 0.01\% + 3\text{ mV}$
Current	$\leq 0.1\% + 3\text{ mA}$	$\leq 0.1\% + 3\text{ mA}$	$\leq 0.1\% + 3\text{ mA}$
<b>Load Regulation</b>			
Voltage	$\leq 0.01\% + 3\text{ mV}$	$\leq 0.01\% + 3\text{ mV}$	$\leq 0.01\% + 3\text{ mV}$
Current	$\leq 0.1\% + 3\text{ mA}$	$\leq 0.1\% + 3\text{ mA}$	$\leq 0.1\% + 3\text{ mA}$
<b>Ripple and Noise</b>			
Voltage	$\leq 1\text{ mVrms}$	$\leq 1\text{ mVrms}$	$\leq 1\text{ mVrms}$
Current	$\leq 3\text{ mArms}$	$\leq 5\text{ mArms}$ (Ch1 and Ch2), $\leq 4\text{ mArms}$ (Ch3)	$\leq 4\text{ mArms}$
<b>Temperature Coefficient (0 °C to 40 °C) <math>\pm</math> (% output + offset) (typical)</b>			
Voltage	$\leq 0.03\% + 10\text{ mV}$		
Current	$\leq 0.1\% + 5\text{ mA}$		
<b>Programming Resolution</b>			
Voltage	1 mV	1 mV	1 mV
Current	1 mA	1 mA	1 mA
<b>Readback Resolution</b>			
Voltage	1 mV	1 mV	1 mV
Current	1 mA	1 mA	1 mA
<b>Programming Accuracy <math>\pm</math> (% output + offset)</b>			
Voltage	$\leq 0.03\% + 10\text{ mV}$		

Current	$\leq 0.1\% + 5 \text{ mA}$	$\leq 0.1\% + 8 \text{ mA}$ (Ch1 and Ch2) $\leq 0.1\% + 5 \text{ mA}$ (Ch3)	$\leq 0.1\% + 5 \text{ mA}$
<b>Readback Accuracy <math>\pm</math> (% output + offset)</b>			
Voltage	$\leq 0.03\% + 10 \text{ mV}$	$\leq 0.03\% + 10 \text{ mV}$	$\leq 0.03\% + 10 \text{ mV}$
Current	$\leq 0.1\% + 5 \text{ mA}$	$\leq 0.1\% + 8 \text{ mA}$ (Ch1 and Ch2) $\leq 0.1\% + 5 \text{ mA}$ (Ch3)	$\leq 0.1\% + 5 \text{ mA}$
<b>Series Accuracy (Combined Mode)</b>			
Current	$\leq 0.05\% + 10 \text{ mA}$		
<b>Parallel Accuracy (Combined Mode)</b>			
Voltage	$\leq 0.02\% + 5 \text{ mV}$		
Current	$\leq 0.1\% + 20 \text{ mA}$		
<b>General</b>			
Memory	4 memory groups with 9 locations in each group		
Remote Interface	USB (USBTMC-compliant), GPIB, RS-232		
AC Input	110/220 VAC (+/- 10%), 47 Hz - 63 Hz		
Operating Temperature	32 °F to 104 °F (0 °C to 40 °C)		
Storage Temperature	-4 °F to 158 °F (-20 °C to 70 °C)		
Dimensions (W×H×D)	8.45" x 3.47" x 13.96" (214.5 x 88.2 x 354.6 mm)	8.45" x 3.47" x 17.52" (214.5 x 88.2 x 445 mm)	
Weight	16.98 lbs. (7.7 kg)	33.07 lbs. (15 kg)	

To ensure the most current version of this manual, please visit [www.bkprecision.com](http://www.bkprecision.com).

## 9 Calibration

We recommend a calibration interval of once per year to ensure that the power supply meets specifications.



# 10 SERVICE INFORMATION

---

**Warranty Service:** Please go to the support and service section on our website at [www.bkprecision.com](http://www.bkprecision.com) to obtain a RMA #. Return the product in the original packaging with proof of purchase to the address below. Clearly state on the RMA the performance problem and return any leads, probes, connectors and accessories that you are using with the device.

**Non-Warranty Service:** Please go to the support and service section on our website at [www.bkprecision.com](http://www.bkprecision.com) to obtain a RMA #. Return the product in the original packaging to the address below. Clearly state on the RMA the performance problem and return any leads, probes, connectors and accessories that you are using with the device. Customers not on an open account must include payment in the form of a money order or credit card. For the most current repair charges please refer to the service and support section on our website.

Return all merchandise to B&K Precision Corp. with prepaid shipping. The flat-rate repair charge for Non-Warranty Service does not include return shipping. Return shipping to locations in North America is included for Warranty Service. For overnight shipments and non-North American shipping fees please contact B&K Precision Corp.

B&K Precision Corp.  
22820 Savi Ranch Parkway  
Yorba Linda, CA 92887  
[www.bkprecision.com](http://www.bkprecision.com)  
714-921-9095

Include with the returned instrument your complete return shipping address, contact name, phone number and description of problem.

# 11 LIMITED THREE-YEAR WARRANTY

---

B&K Precision Corp. warrants to the original purchaser that its products and the component parts thereof, will be free from defects in workmanship and materials for a period of **three years** from date of purchase.

B&K Precision Corp. will, without charge, repair or replace, at its option, defective product or component parts. Returned product must be accompanied by proof of the purchase date in the form of a sales receipt.

To help us better serve you, please complete the warranty registration for your new instrument via our website [www.bkprecision.com](http://www.bkprecision.com)

**Exclusions: This warranty does not apply in the event of misuse or abuse of the product or as a result of unauthorized alterations or repairs. The warranty is void if the serial number is altered, defaced or removed.**

B&K Precision Corp. shall not be liable for any consequential damages, including without limitation damages resulting from loss of use. Some states do not allow limitations of incidental or consequential damages. So the above limitation or exclusion may not apply to you.

This warranty gives you specific rights and you may have other rights, which vary from state-to-state.

B&K Precision Corp.  
22820 Savi Ranch Parkway  
Yorba Linda, CA 92887  
[www.bkprecision.com](http://www.bkprecision.com)  
714-921-9095



22820 Savi Ranch Parkway  
Yorba Linda, CA 92887  
[www.bkprecision.com](http://www.bkprecision.com)

© 2015 B&K Precision Corp.

## **X-ON Electronics**

Largest Supplier of Electrical and Electronic Components

*Click to view similar products for [B&K Precision](#) manufacturer:*

Other Similar products are found below :

[BK4007B](#) [575A](#) [8612](#) [878](#) [9121A](#) [9123A](#) [9206](#) [1514](#) [1737](#) [1747](#) [1760A](#) [2125C](#) [CAL73](#) [9115](#) [9116](#) [9117](#) [9120A](#) [9122A](#) [9202](#) [9801](#)  
[1627A](#) [1730A](#) [2516](#) [2532B](#) [2556](#) [2557](#) [PR-37AR](#) [262](#) [2704C](#) [KIT](#) [307A](#) [308](#) [CR-43](#) [340A](#) [4005DDS](#) [4012A](#) [TL8KC1](#) [TL8SM](#) [367A](#) [391](#)  
[4017A](#) [4055](#) [4064](#) [4065](#) [XLN30052](#) [8500](#) [XLN3640](#) [4055B](#) [9174B](#) [369B](#) [CC510](#)