

## 36V High Efficiency Boost Converter with I<sup>2</sup>C Controlled 6-CH LED Driver

### General Description

The RT8555 is a high efficiency driver for white LEDs. It is suitable for single/two cell battery input to drive LED light bars which contains six strings in parallel and up to 10 WLEDs per string. The internal current sinks support a maximum of ±2% current mismatching for excellent brightness uniformity in each string of LEDs. To provide enough headroom for current sink operation, the Boost controller monitors the minimum voltage of the feedback pins and regulates an optimized output voltage for power efficiency.

The RT8555 has a wide input voltage operating range from 2.7V to 24V and contains I<sup>2</sup>C interface for controlling the dimming mode, operating frequency and the LED current. The internal 100mΩ, 36V power switch with current-mode control provides over-current protection. The switching frequency of the RT8555 is adjustable from 300kHz to 2MHz, which allows flexibility between efficiency and component size.

The RT8555 is available in the WL-CSP-20B 1.65 x 2.05 (BSC), with pitch 0.4mm package.

### Ordering Information

RT8555 □  
 └─ Package Type  
 WSC : WL-CSP-20B 1.65x2.05 (BSC)

Note :

Richtek products are :

- ▶ RoHS compliant and compatible with the current requirements of IPC/JEDEC J-STD-020.
- ▶ Suitable for use in SnPb or Pb-free soldering processes.

### Marking Information

1XW	1X : Product Code
●	W : Date Code

### Features

- Wide Operating Input Voltage : 2.7V to 24V
- High Output Voltage : Up to 36V
- Programmable Channel Current : 10mA to 35mA
- Channel Current Regulation with Accuracy ±3% and Matching ±2%
- Dimming Controls
  - ▶ Direct PWM Dimming up to 20kHz and Minimum On-Time to 400ns
  - ▶ PWM to Analog Dimming up to 20kHz with 8-bit Resolution
- I<sup>2</sup>C Programs LED Current, Switching Frequency, Dimming Mode
- Switching Frequency : 300kHz to 2MHz
- Protections
  - ▶ LED Strings Open Detection
  - ▶ Current Limit
  - ▶ Programmable Over Voltage Protection
  - ▶ Over-Temperature Protection
- 20-Ball WL-CSP, with pitch 0.4mm Package
- RoHS Compliant and Halogen Free

### Applications

- Tablet and Notebook Backlight

### Pin Configurations

(TOP VIEW)

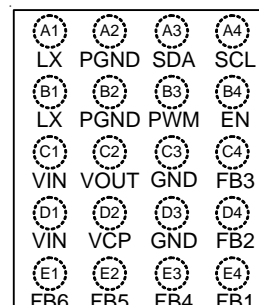

WL-CSP-20B 1.65 x 2.05 (BSC)

## Functional Pin Description

Pin No.	Pin Name.	Pin Function
A1, B1	LX	Switch Node of Boost Converter.
A2, B2	PGND	Power Ground.
A3	SDA	Data Signal Input of I <sup>2</sup> C Interface.
A4	SCL	Clock Signal Input of I <sup>2</sup> C Interface.
B3	PWM	PWM Dimming Control Input.
B4	EN	Enable Control Input (Active High).
C1, D1	VIN	Power Input.
C2	VOOUT	Output of Boost Converter.
C3, D3	GND	Ground.
C4	FB3	Current Sink for LED3.
D2	VCP	Output of Internal Regulator.
D4	FB2	Current Sink for LED2.
E1	FB6	Current Sink for LED6.
E2	FB5	Current Sink for LED5.
E3	FB4	Current Sink for LED4.
E4	FB1	Current Sink for LED1.

**Function Block Diagram**

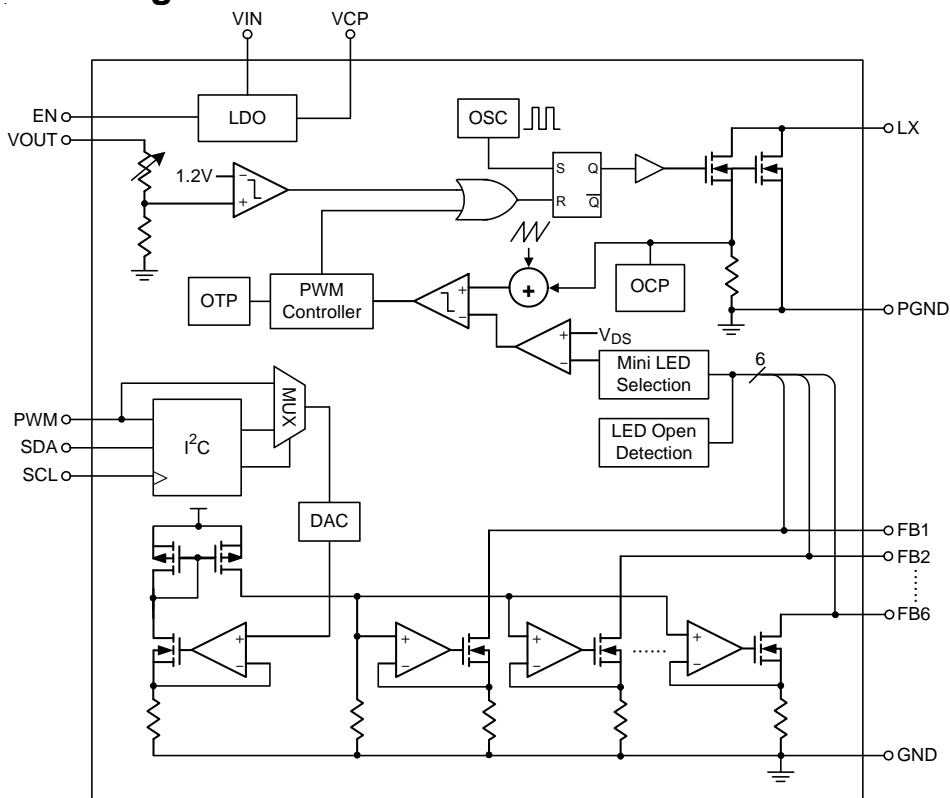

**Operation**

**Enable Control**

When VIN is higher than the UVLO voltage and the EN pin input voltage is higher than rising threshold, the VDC will be regulated around 3.2V if VIN is higher than 3.2V.

**Switching Frequency**

The LED driver switching frequency is adjusted by the I²C. The switching frequency is from 300kHz to 1.9MHz.

**PWM Controller**

This controller includes some logic circuit to control LX N-MOSFET on/off. This block controls the minimum on-time and max duty of LX.

**OCP & OTP**

When LX N-MOSFET peak current is higher than 2.5A(typically), the LX N-MOSFET is turned off immediately and resumed again at next clock pulse. When the junction temperature is higher than 150°C (typically), the LXN-MOSFET will be turned off until the temperature is lower than the 130°C (typically).

**OVP**

The RT8555 integrates over voltage protection. The over voltage protection could be set by the I²C, When the OVP pin voltage is higher than 36V, the LX N-MOSFET is turned off immediately to protect the LX N-MOSFET.

**Minimum LED Selection**

This block detects all LEDx voltage and select a minimum voltage to EA (Error Amplifier). This function can guarantee the lowest of the LED pin voltage is around 500mV and Vout can be Boost to the highest forward voltage of LED strings.

**LED Open Detection**

If the voltage at LEDx pin is lower than 100mV, this channel is defined as open channel and the Minimum LED Selection function will discard it to regulate other used channels in proper voltage.

## Absolute Maximum Ratings (Note 1)

- Supply Voltage, VIN to GND ----- -0.3V to 26.4V
- LX, VOUT, FB1, FB2, FB3, FB4, FB5, FB6 to GND ----- -0.3V to 40V
- EN, PWM, SDA, SCL, VCP to GND ----- -0.3V to 6V
- Power Dissipation, PD @ TA = 25°C
  - WL-CSP-20B 1.65 x 2.05 (BSC) ----- 2.72W
- Package Thermal Resistance (Note 2)
  - WL-CSP-20B 1.65 x 2.05 (BSC), θJA ----- 36.7°C/W
- Junction Temperature ----- 150°C
- Lead Temperature (Soldering, 10 sec.) ----- 260°C
- Storage Temperature Range ----- -65°C to 150°C
- ESD Susceptibility (Note 3)
  - HBM (Human Body Model) ----- 2kV
  - MM (Machine Model) ----- 200V

## Recommended Operating Conditions (Note 4)

- Junction Temperature Range ----- -40°C to 125°C
- Ambient Temperature Range ----- -40°C to 85°C

## Electrical Characteristics

(VIN = 3.8V, CIN = 1μF, TA = 25°C, unless otherwise specified)

Parameter	Symbol	Test Conditions	Min	Typ	Max	Unit
<b>Input Power Supply</b>						
Input Supply Voltage	VIN		2.7	3.8	24	V
Quiescent Current	IQ	LX no switching	--	2.7	--	mA
Shutdown Current	ISHDN	VIN = 3.8V, EN = 0V	--	--	1	μA
Under-Voltage Lockout Threshold	VUVLO	VIN Rising	--	2.3	--	V
Under-Voltage Lockout Hysteresis	ΔVUVLO		--	200	--	mV
Over-Temperature Protection Threshold	TOTP		--	150	--	°C
Over-Temperature Protection Hysteresis	TOTP_HYS		--	20	--	°C
<b>Interface Characteristic</b>						
EN, PWM, SCL, SDA Input Voltage	Logic-High	VIH	1.4	--	--	V
	Logic-Low	VIL	--	--	0.8	V
Internal Pull-Low Current for EN, PWM	IiH_1		--	--	10	μA
Internal Pull-Low Current for SCL, SDA	IiH_2		--	0.01	1	μA
Output Low Level for SDA	VOL	External Pull High Current = 3mA	--	0.3	0.5	V
Output Leakage Current for SDA	ILK_DIO	SDA Pin Voltage = 3.3V	--	--	1	μA
<b>I<sup>2</sup>C Interface Timing</b>						
Maximum I <sup>2</sup> C Clock Frequency	fSC_MAX		--	400	--	kHz

Parameter	Symbol	Test Conditions	Min	Typ	Max	Unit
Hold Time for START And Repeated START Condition	t <sub>HD,STA</sub>		0.6	--	--	μs
SCL Clock Low Time	t <sub>LOW</sub>		1.3	--	--	μs
SCL Clock High Time	t <sub>HIGH</sub>		600	--	--	ns
Setup Time for A Repeated START Condition	t <sub>SU,STA</sub>		600	--	--	ns
SDA Data Hold Time	t <sub>HD,DAT</sub>		50	--	--	ns
SDA Data Setup Time	t <sub>SU,DAT</sub>		100	--	--	ns
Rising Time of SDA, SCL	t <sub>R</sub>		--	--	300	ns
Falling Time of SDA, SCL	t <sub>F</sub>		--	--	300	ns
Setup Time for STOP Condition	t <sub>SU,STO</sub>		600	--	--	ns
I <sup>2</sup> C Bus Free Time Between a STOP and a START	t <sub>BUF</sub>		1.3	--	--	μs
Capacitive Load for I <sup>2</sup> C Bus	C <sub>B</sub>		--	--	400	pF
<b>Boost Converter</b>						
Switching Frequency Accuracy	f <sub>SW_ACC</sub>	Boost Operates at PWM Mode, f <sub>SW</sub> = 600kHz	-10	--	10	%
Switching Frequency Setting Range	f <sub>SW_RG</sub>	Boost Operates at PWM Mode	0.3	--	2	MHz
Maximum Duty Cycle	D <sub>MAX</sub>	f <sub>SW</sub> = 600kHz	--	95	--	%
Boost Switch R <sub>DS(ON)</sub>	R <sub>DS(ON)</sub>		--	0.1	0.3	Ω
Switching Current Limitation	I <sub>OC</sub>		2	2.5	3	A
<b>LED Current</b>						
Leakage Current of FBx	I <sub>LK_FB</sub>	V <sub>FBx</sub> = 36V, I <sub>FBx</sub> = 0mA	--	--	1	μA
Minimum FBx Regulation Voltage	V <sub>FB(MIN)</sub>	I <sub>FBx</sub> = 20mA	0.3	--	--	V
Maximum LED Current Setting	I <sub>FB(MAX)</sub>	LED 100% Setting	10	--	35	mA
Minimum LED Current Setting	I <sub>FB(MIN)</sub>	Setting By Dimming	0.2	--	--	mA
LED Current Accuracy	I <sub>FB_ACC</sub>	PWM Duty = 100%, I <sub>FBx</sub> = 20mA	-3	--	3	%
LED Current Matching	I <sub>FB_MAT</sub>	PWM Duty = 100%, I <sub>FBx</sub> = 20mA	-2	--	2	%
FBx Channel Unused Threshold	V <sub>FB_UNUSE</sub>		--	0.1	--	V
Light Bar Open Threshold	V <sub>FB_OPEN</sub>		--	0.1	--	V
PWM Minimum On Duty	D <sub>PWM_MIN</sub>	PWM Dimming Frequency = 20kHz	0.8	--	--	%

**Note 1.** Stresses beyond those listed “Absolute Maximum Ratings” may cause permanent damage to the device. These are stress ratings only, and functional operation of the device at these or any other conditions beyond those indicated in the operational sections of the specifications is not implied. Exposure to absolute maximum rating conditions may affect device reliability.

**Note 2.** θ<sub>JA</sub> is measured at T<sub>A</sub> = 25°C on a high effective thermal conductivity four-layer test board per JEDEC 51-7.

**Note 3.** Devices are ESD sensitive. Handling precaution is recommended.

**Note 4.** The device is not guaranteed to function outside its operating conditions.

## Typical Application Circuit

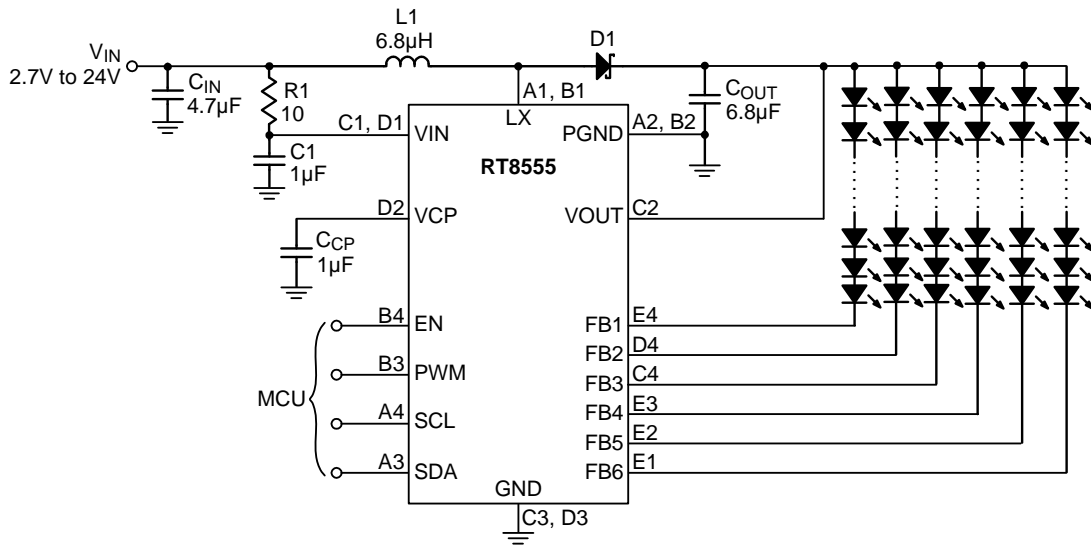

Note : For unused channels (FBx), please connect FBx pin to GND.

**Timing Diagram**

**I<sup>2</sup>C Interface**

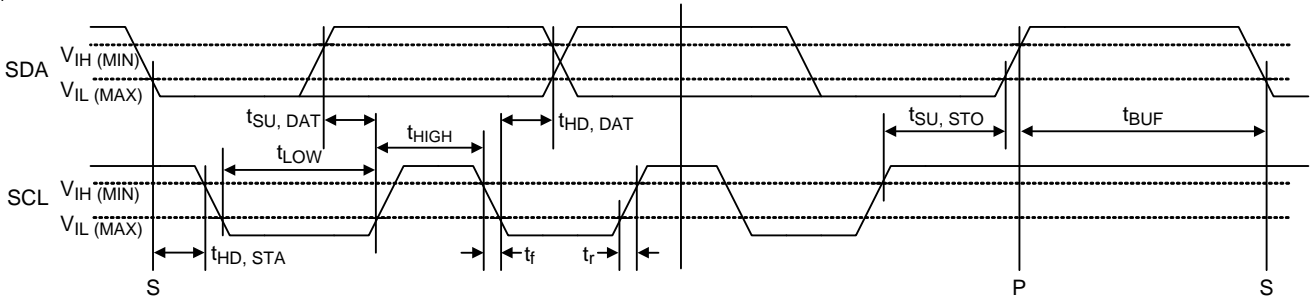

RT8555 I<sup>2</sup>C slave address = 7'b0110\_001. I<sup>2</sup>C interface support fast mode (bit rate up to 400kb/s). The write or read bit stream ( $N \geq 1$ ) is shown below

**Read N bytes from RT8555**

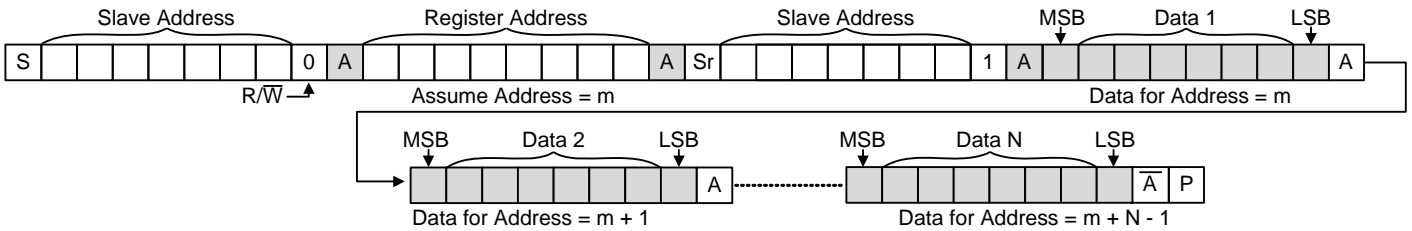

**Write N bytes to RT8555**

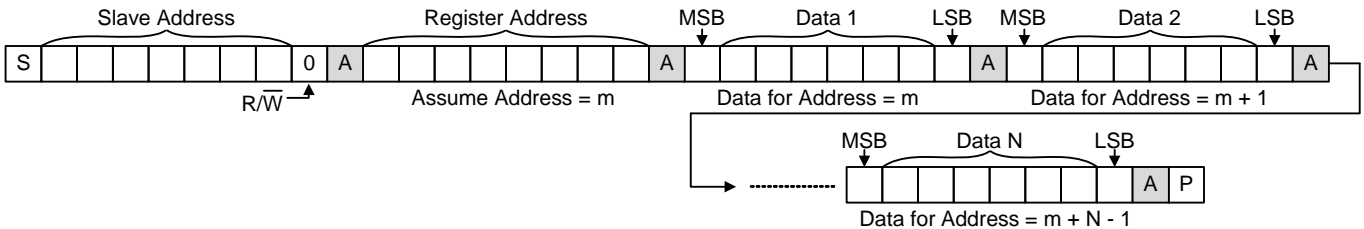

□ Driven by Master, ■ Driven by Slave (RT8555), □ P Stop, □ S Start, □ Sr Repeat Start

Typical Operating Characteristics

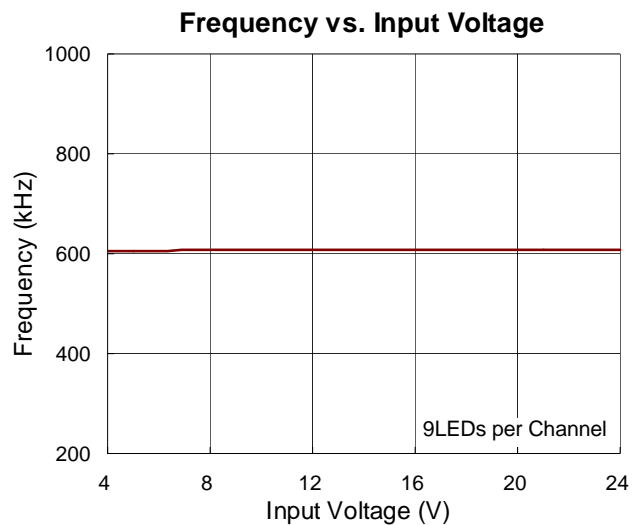
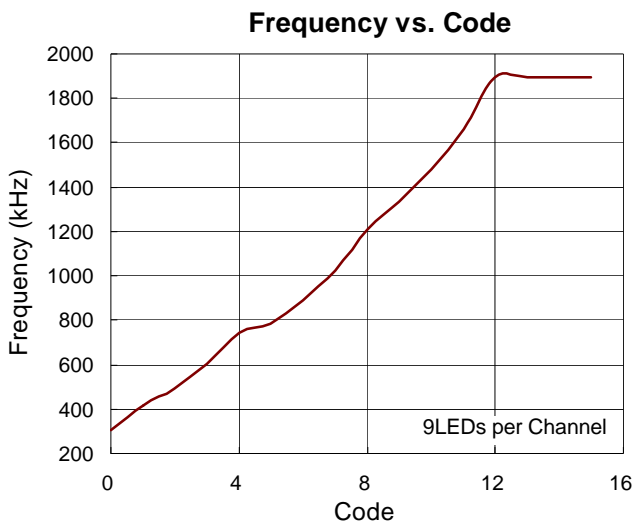
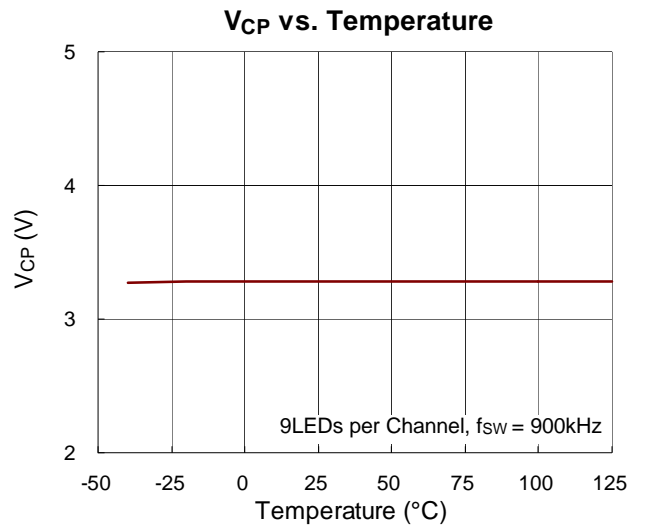
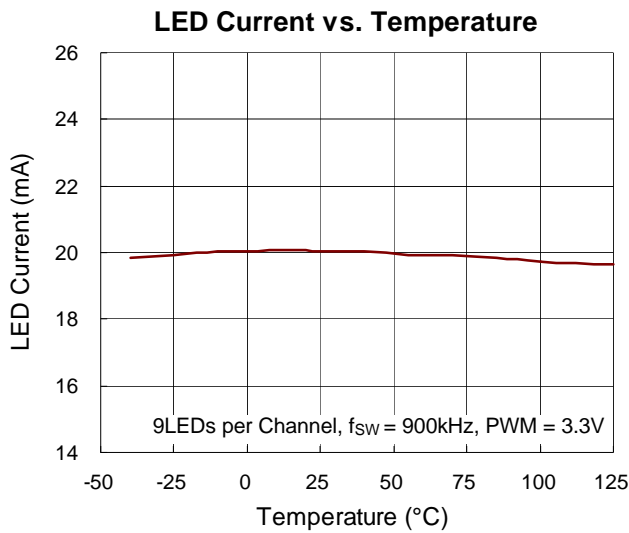
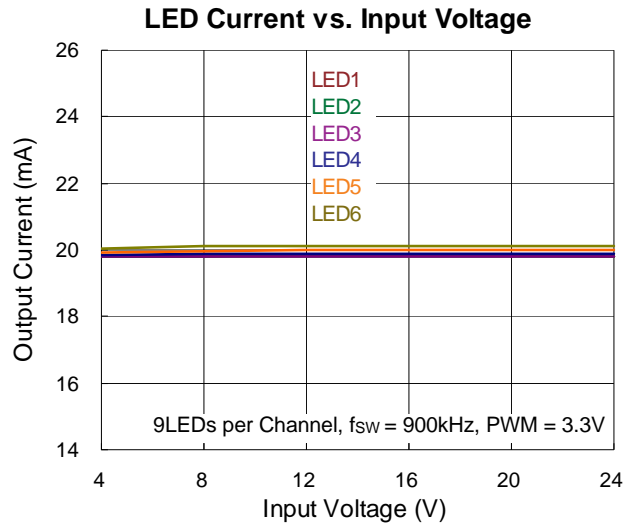
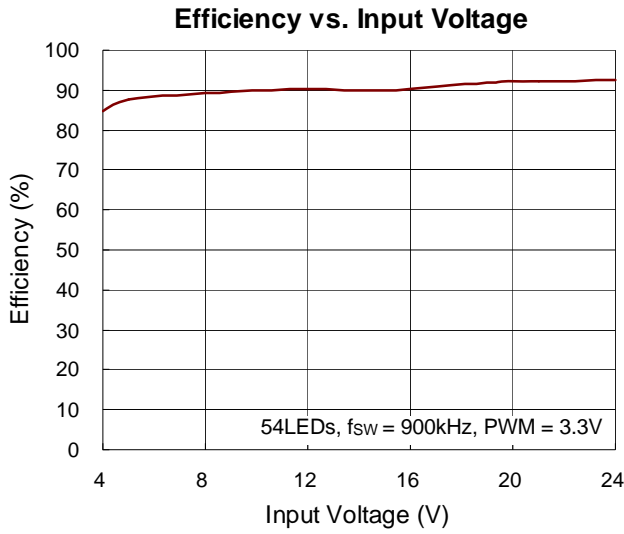



**LED Current vs. PWM Duty Cycle**

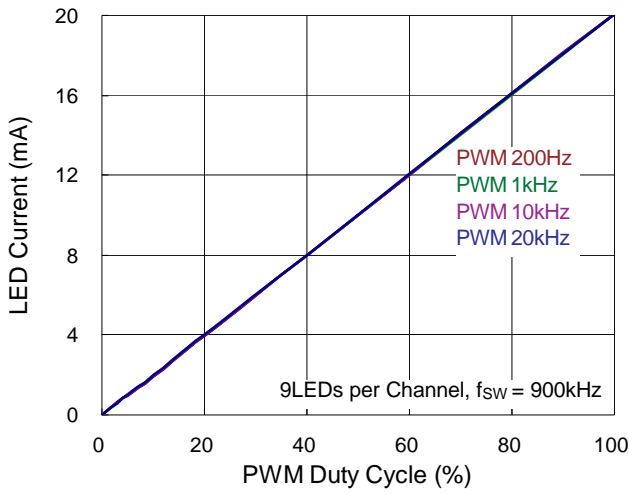

**OVP Threshold Voltage vs. Input Voltage**

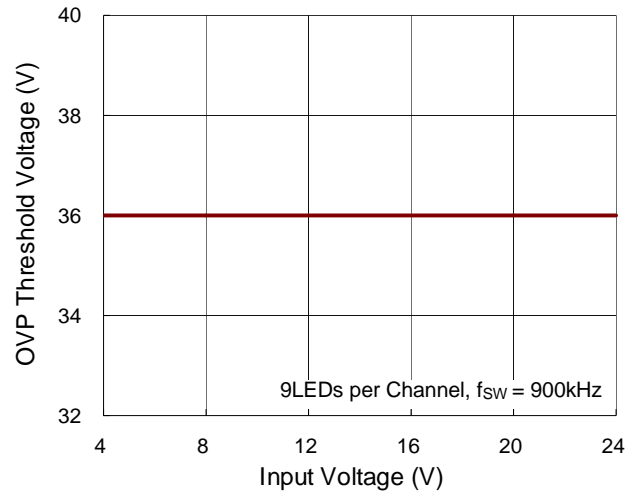

**Quiescent Current vs. Input Voltage**

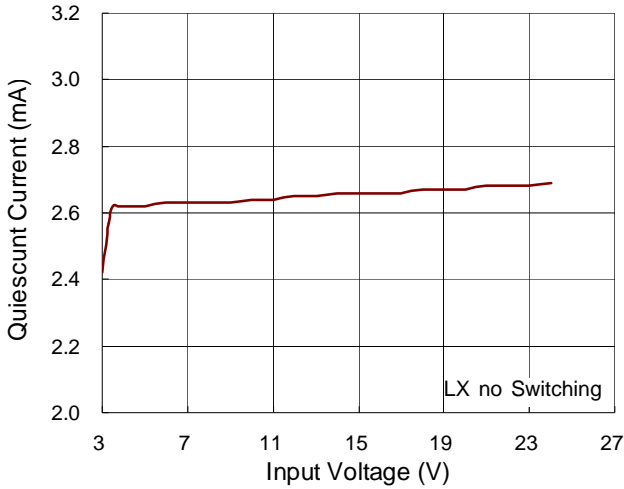

**Line Transient Response**

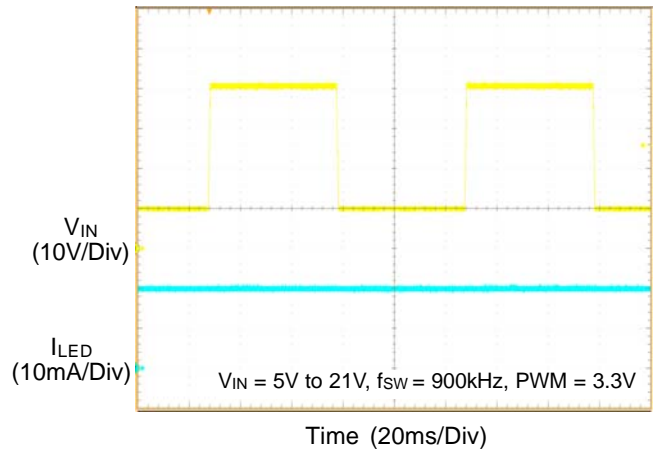

**Power On from EN**

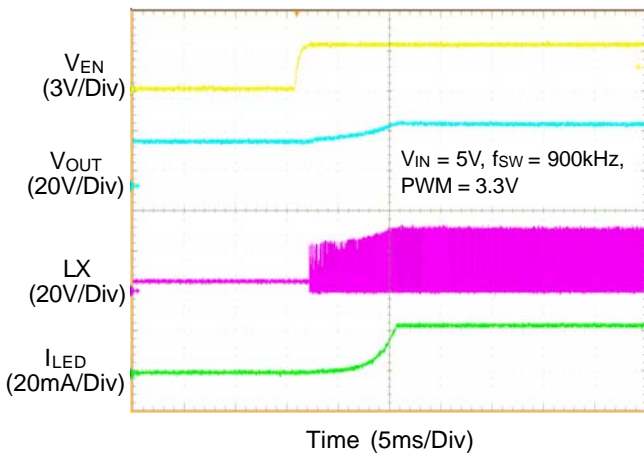

**Power Off from EN**

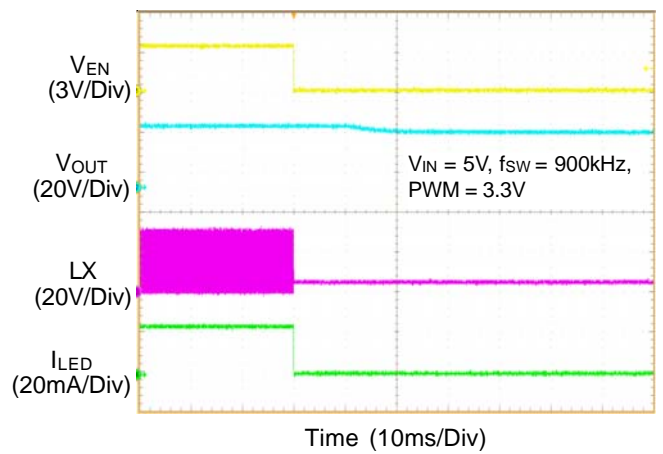

Application Information

Table 1. Register Map

Slave Address : b0110001									
Register Address	bit7	bit6	bit5	bit4	bit3	bit2	bit1	bit0	Default Value
0x00	MIX-26K	Edge Rate Control		Spread Spectrum	Mixed Mode Change Duty		ILED Brightness Selection	Dimming Mode Selection	0x4c
0x01	10 bit mode selection	Over Voltage Protection Selection		Switching Current Limitation Selection	Boost Switching Frequency				0x76
0x02	ILED Current Setting								0x92
0x03		LDO Regulation Voltage Setting		ILED Brightness Compensation Ratio					0x00
0x04	ILED Brightness LSB Register 1								0x00
0x05							ILED Brightness MSB Register 1		0x00
0x06	ILED Brightness LSB Register 2								0x00
0x07							ILED Brightness MSB Register 2		0x00
0x08		Smart Dither Slope Time Control			LED driver headroom		Advanced Brightness Control		0x00
0x09		Fade In / Out Time Control		Smart Dither Enable	DC Dither Enable	PWM Dither Enable	Dither Resolution		0x1C
0x0A	26KHz Mode Division Frequency						Soft Start Time Control		0x04
0x0B	Stop Compensation Duty								0x00
0x0D	Control CLK PFM Function Enable								0x00
0x0E			LED Unused Check		LED OVP Level				0x00
0x50									0x06
0x51									0x00

Note : Blank part in table is restricted register.

The RT8555 is a general purpose 6-CH LED driver and is capable of delivering a maximum 35mA LED current. The IC is a current mode Boost converter integrated with a 2.5A power switch and can cover a wide VIN range from 2.7V to 24V and contains I<sup>2</sup>C interface for controlling the dimming mode, operating frequency and the LED current. The internal 100mΩ, 36V power switch with current-mode control provides over current protection. The switching frequency of the RT8555 is adjustable from 300kHz to 2MHz, which allows flexibility between efficiency and component size.

- ▶ LED constant current
- ▶ Boost switching frequency
- ▶ Slope for brightness changes
- ▶ Output Current Resolution
- ▶ Dithering options
- ▶ Start-up time
- ▶ Current limit protection
- ▶ Over voltage protection
- ▶ LDO regulation voltage setting

Programmable functions include :

- ▶ PWMO frequencies

**Brightness Control by PWM Pin**

The RT8555 provide three dimming modes for controlling the LED brightness. The three dimming modes include PWM mode, DC mode and Mixed mode, and the dimming mode could be set by register 00h.

**Table 2. Dimming Control Mode Selection**

Address	Bit	Name	Default Value	Description	R/W
00h	[0]	Dimming Mode Selection	PWM Mode (B0)	B0 : PWM mode B1 : Mixed mode	R/W
	[3:2]	Mixed Mode Change Duty	25% (B11)	B00 : 0% B01 : 6.25% B10 : 12.5% B11 : 25%	R/W
	[7]	MIX-26K	PWM pin (B0)	B0 : follow PWM pin frequency B1 : fixed 26kHz	R/W

Note : DC mode = Dimming Mode Selection (00h[0] = B1) + Mixed Mode Change Duty = 0% (00h[3:2] = B00)

**PWM Mode**

The ON/OFF of the current source is synchronized to the PWM signal. The frequency of LED current is equal to the PWM input signal.

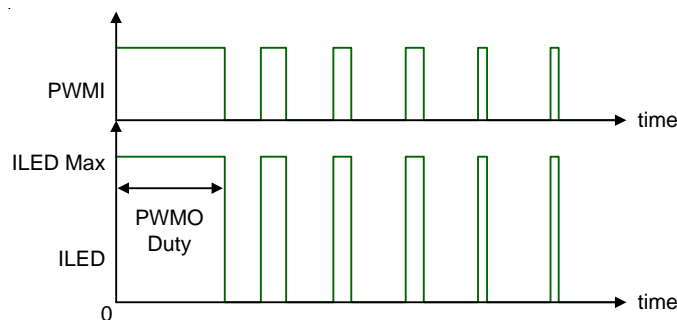

Figure 1. PWM Dimming

**DC Mode**

The LED current will have two cycle delay in this mode, while the delay cycles are for average current calculation.

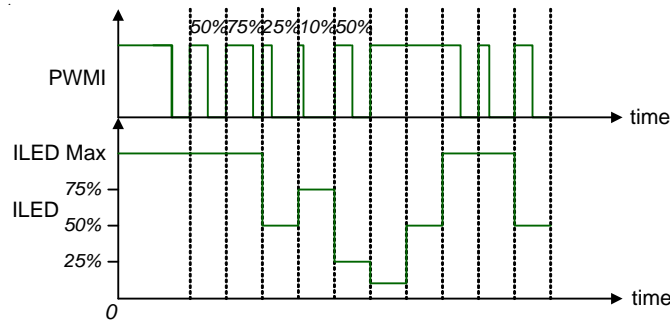

Figure 2. DC Dimming

**Mixed Mode**

In 25% Mixed mode, 25% the PWM input signal and LED current are both delayed by two cycles with additional variations.

- ▶ When  $25\% \leq \text{PWM duty} \leq 100\%$ , the PWM duty modulated the amplitude of the current. (Same as DC mode)
- ▶ PWM duty  $< 25\%$ , the DC dimming will translate to PWM dimming, controlling the PWM duty instead by amplitude. The LED current is fixed on quarter of LED current setting.

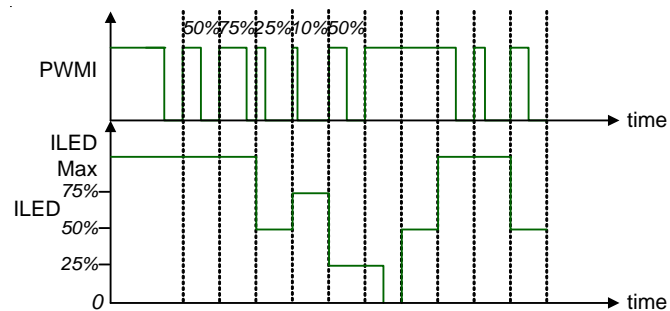

Figure 3. Mixed Mode Dimming

**Brightness Control Signal Selection**

The RT8555 integrates a dimming control signal selection. The dimming control signal source could be set by the second bit of register 00h. If the bit equals to 0, it means the dimming control signal source just depends on the input signal of the PWM pin. Otherwise, if the bit equals to 1, the dimming control signal is controlled by the command of register 04/05h. The option is shown in Table 3 below.

**Table 3. Dimming Control Signal Selection**

Address	Bit	Name	Default Value	Description	R/W
00h	[1]	ILED Brightness Selection	PWM Pin (B0)	B0 : depend on the status of PWM pin B1 : depend on address:04/05h data	R/W

**Switching Frequency**

The LED driver switching frequency is adjusted by the I<sup>2</sup>C, the switching frequency setting range, Spread Spectrum, LX Slew Rate and resolutions are shown in the Table 4 below.

**Table 4. Switching Frequency Setting**

Address	Bit	Name	Default Value	Description	Resolution	R/W
00h	[4]	Spread Spectrum	w/o (B0)	B0 : w/o B1 : w/i		R/W
00h	[6:5]	Edge Rate Control	Fast (B10)	B00 : Slow B01 : Normal B10 : Fast		R/W
01h	[3:0]	Boost Switching Frequency	900kHz (0x06h)	0x00h : 300kHz 0x07h : 1MHz 0x0Ch : 2MHz	100kHz (0x00h to 0x07h) 200kHz (0x07h to 0x0Ch)	R/W

If the switching frequency command is below to register 0x01. The switching frequency is from 300kHz to 1MHz and resolution is 100kHz. The switching frequency is from 1MHz to 2MHz and resolution is 200kHz.

**Current Limit Protection**

The RT8555 integrates current limit protection, and the current of current limit protection could be set by I<sup>2</sup>C, which is shown in the Table 5 below.

**Table 5. Current Limit Protection Setting**

Address	Bit	Name	Default Value	Description	Resolution	R/W
01h	[4]	Switching Current Limitation Selection	2.5A (B1)	B0 : 1.5A B1 : 2.5A	--	R/W

The RT8555 can limit the peak current to achieve over current protection. The RT8555 senses the inductor current during the "ON" period that flows through the LX pin. The duty cycle depends on the current signal and internal slope compensation in comparison with the error signal. The internal switch of Boost converter will be turned off when the peak current value of inductor current is larger than the over current protection setting. In the "OFF" period, the inductor current will be decreased until the internal switch is turned on by the oscillator.

**Over Voltage Protection**

The RT8555 integrates over voltage protection. The over voltage protection could be set by the I<sup>2</sup>C, the voltage of over voltage protection (V<sub>OVP</sub>) could be selected as the Table 6 below.

**Table 6. OVP Voltage Setting**

Address	Bit	Name	Default Value	Description	Resolution	R/W
01h	[6:5]	Over Voltage Protection Selection	36V (B11)	Boost output over voltage protection. B00 : 25V B01 : 28V B10 : 32V B11 : 36V	--	R/W

When the Boost output voltage rises above the V<sub>OVP</sub>, the internal switch will be turned off. Once the Boost output voltage drop below the V<sub>OVP</sub>, the internal switch will be turned on again. The Boost output voltage can be clamped at the V<sub>OVP</sub>.

**LED Current Setting**

The LED current of each channel could be set by I<sup>2</sup>C command; it is shown in the Table 7.

**Table 7. LED Current Setting**

Address	Bit	Name	Default Value	Description	Resolution	R/W
02h	[7:0]	ILED Current Setting	20.04mA (0x92h)	Control the max current 0x00h : 0mA 0x01h to 0x49h : 10.02mA 0x49h : 10.02mA 0x92h : 20.04mA 0xFFh : 35mA	~0.137mA (0x49h to 0xFFh)	R/W

When the LED current setting command is below 0x92h, the LED current will be kept at 20.04mA. When the command is 0x00h, the LED current will be set to 0mA. the maximum LED current setting is 35mA. The one step of LED current is approximately 0.137mA.

**LDO Regulation Voltage Setting**

The LDO regulation voltage could be set by the I<sup>2</sup>C, it is shown in the Table 8.

**Table 8. LDO Regulation Voltage Setting**

Address	Bit	Name	Default Value	Description	Resolution	R/W
03h	[6:5]	LDO Regulation Voltage Setting	3.2V (B00)	LDO regulation voltage setting B00: 3.2V B01: 3.4V B10: 3.6V B11:4.6V	--	R/W

When the LDO regulation voltage setting command is below B00, the LDO regulation voltage will be kept at 3.2V. The maximum LDO setting is 4.6V. The setting condition is smaller than the input voltage.

**Brightness Control by I<sup>2</sup>C Register**

With brightness register control the output current is controlled with 8-bit resolution or 10-bit resolution register bits. It is shown in the Table 9.

**Table 9. Brightness Register**

Address	Bit	Name	Default Value	Description	Resolution	R/W
01h	[7]	10 bit mode selection	8bit (B0)	B0 : 8 bit mode B1 : 10 bit mode		R/W
04h	[7:0]	ILED Brightness LSB Register 1	0% (0x00h)	0x00h : 0% 0xFFh : 100%	~ 0.4%	R/W
05h	[1:0]	ILED Brightness MSB Register 1	0% (0x00h)	If 01h[7] is 1, need 04h & 05h series write and then ILED brightness change		R/W
06h	[7:0]	ILED Brightness LSB Register 2	0% (0x00h)	0x00h : 0% 0xFFh : 100%	~ 0.4%	R/W
07h	[1:0]	ILED Brightness MSB Register 2	0% (0x00h)	If 01h[7] is 1, need 06h & 07h series write and then ILED brightness change		R/W

**ILED Brightness Compensation**

ILED Brightness compensation which is shown in the Table 10 below.

**Table 10. ILED Brightness Compensation**

Address	Bit	Name	Default Value	Description	Resolution	R/W
03h	[4:0]	ILED Brightness compensation ratio	No compensation (0x00h)	Compensation ratio. Formula : $I_{LED} / 1023 \times \{DAC - [DAC \times (1023 - DAC) \times k] / 1023 / 31\}$		R/W
0Bh	[7:0]	Stop compensation duty	0x00h	PWM duty compensation stop ratio		R/W

**Note :** ILED = ILED Current Setting (02h[7:0])

DAC = PWM pin Duty or ILED Brightness (04h[7:0], 05h[1:0] or 06h[7:0], 07h[1:0])

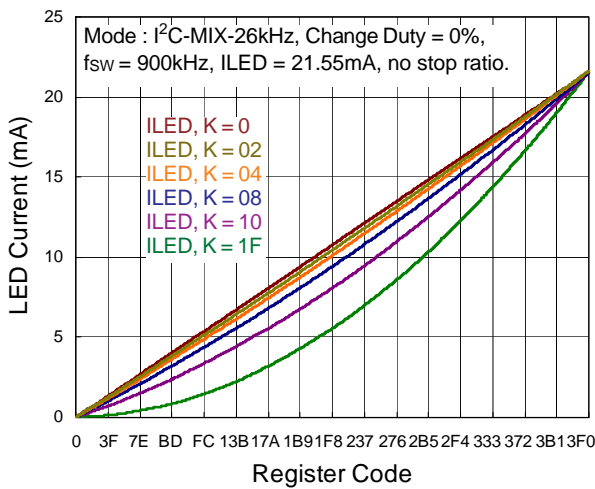

Figure 4. LED Current (Different Compensation Ratio) vs. Register Code

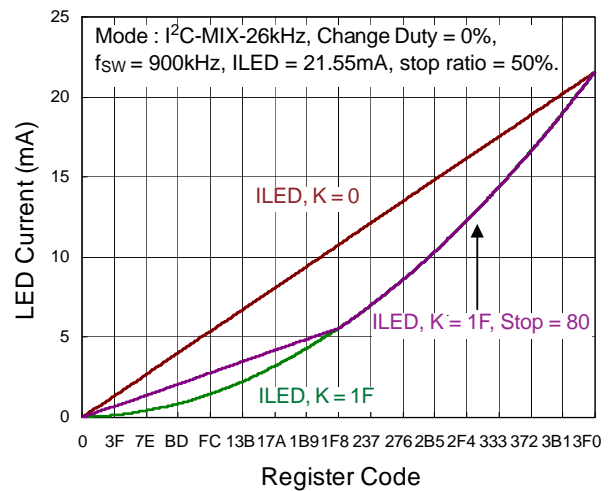

Figure 5. LED Current vs. Register Code

**Advanced Brightness Control**

Dimming control is received either from PWM input pin or from I<sup>2</sup>C register bits which is shown in the Table 11 below.

**Table 11. Advanced Brightness Control**

Address	Bit	Name	Default Value	Description	Resolution	R/W
08h	[1:0]	Advanced Brightness Control	B00	B00 : PWMO = PWMI or I <sup>2</sup> C (04h, 05h) B01 : PWMO = PWMI multiply I <sup>2</sup> C(04h, 05h) or I <sup>2</sup> C(04h, 05h) B10 : PWMO = PWMI multiply I <sup>2</sup> C(06,07h) or I <sup>2</sup> C(04h, 05h) multiply I <sup>2</sup> C (06, 07h) B11 : same as B10		R/W

Table 12. Brightness Control Table

	B Control2	B Control1	pwm/26K	Mix Mode Duty	PWM/I <sup>2</sup> C	PWM/MIX	I <sup>2</sup> C Max	PWMO Duty
Register MODE	08h[1]	08h[0]	00[7]	00h[3:2]	00h[1]	00h[0]		
PWM	0	0	0	Don't care	0	0	PWMI	PWMI
PWM*I <sup>2</sup> C	0	1	0	Don't care	0	0	PWMI* 04h, 05h	PWMI
I <sup>2</sup> C-PWM-26K	0	0	1	Don't care	1	0	04h, 05h	04h, 05h
I <sup>2</sup> C-DC-26K	0	0	1	00	1	1	04h, 05h	

**LED Driver Headroom**

The LED driver headroom could be set by the I<sup>2</sup>C, it is shown in the Table 13.

Table 13. LED Driver Headroom

Address	Bit	Name	Default Value	Description	Resolution	R/W
08h	[3:2]	LED driver headroom	B00	LED driver headroom B00 : 500mV B01 : 570mV B10 : 600mV B11 : 700mV	--	R/W

The RT8555 detects all FBx voltage and selects a minimum voltage to EA (Error Amplifier). When the LED driver headroom command is below B00, the LED driver headroom will be kept at 500mV and V<sub>OUT</sub> can be boost to the highest forward voltage of LED strings. This function can guarantee the highest of FB pin voltage is 700mV.



**Fade IN / OUT Time Control**

The fade in / out time control could be set by the I<sup>2</sup>C, it is shown in the Table 14.

**Table 14. Fade In / Out Time Control**

Address	Bit	Name	Default Value	Description	Resolution	R/W
09h	[6:5]	Fade IN / OUT Time Control	B00	DC mode fade time control B00 : 0.5μs B01 : 1μs B10 : 2μs B11 : 4μs	--	R/W

Fade in / out time can be control by address 09h[6:5], there are four brightness times that adjust range from 0.5μs to 4μs. When the fade in/out command is below B00, the brightness time of per step will be kept at 0.5μs. This function can guarantee the highest of fade in/out time is 4μs. The Figure 6 shows the fade in time at 10 bit resolution. The Figure 7 shows the fade out time at 10 bit resolution.

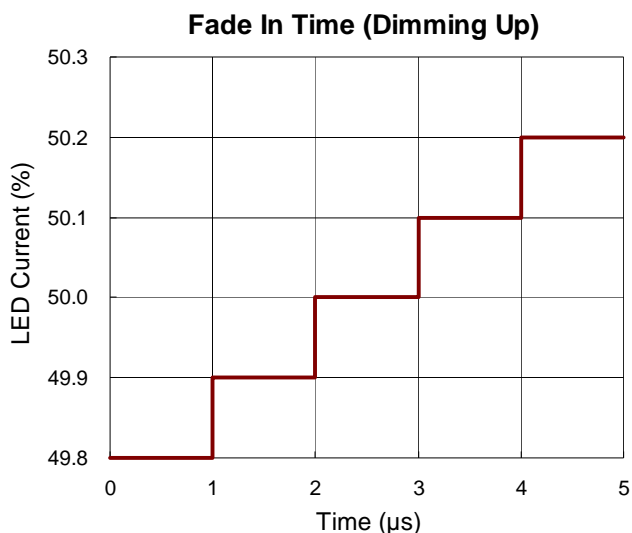

Figure 6. LED Current (Dimming Up) vs. Fade IN Time

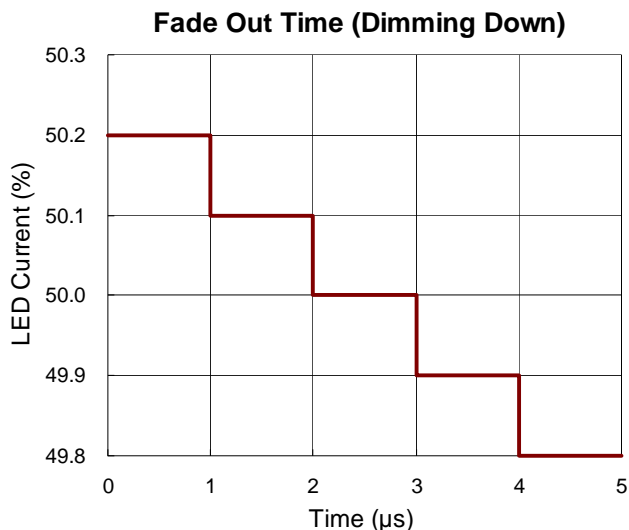

Figure 7. LED Current (Dimming Down) vs. Fade Out Time

**Soft-Start Time Control**

The soft-start time control could be set by the I<sup>2</sup>C, it is shown in the Table 15.

**Table 15. Soft Start Time Control**

Address	Bit	Name	Default Value	Description	Resolution	R/W
0Ah	[1:0]	Soft-Start Time Control	B00	Soft start time control B00 : x1 B01 : x2 B10 : x4 B11 : x8	--	R/W

Soft-start time can be control by address 0Ah[1:0], there are four soft start times that adjust range from 1 time to 8 time. When the command is below B00, the soft start time will be kept at 1 time. This function can guarantee the highest of soft start time is 8 time. The Figure 8 shows the soft start time at power on. The Figure 9 shows the soft start time at power off.

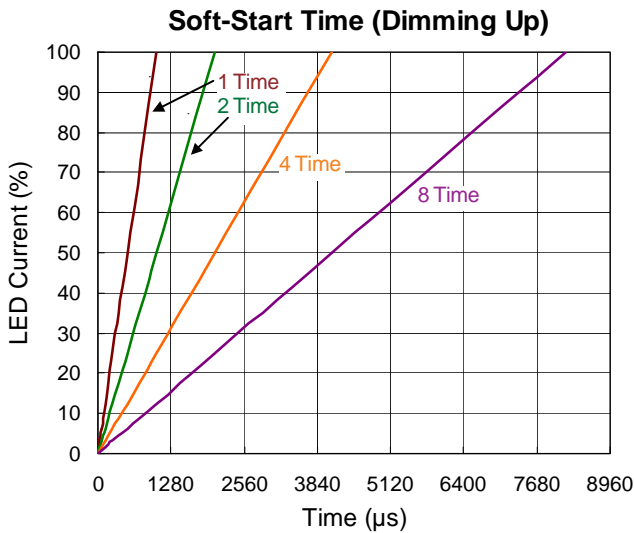

Figure 8. LED Current (Dimming Up) vs. Soft Start Time

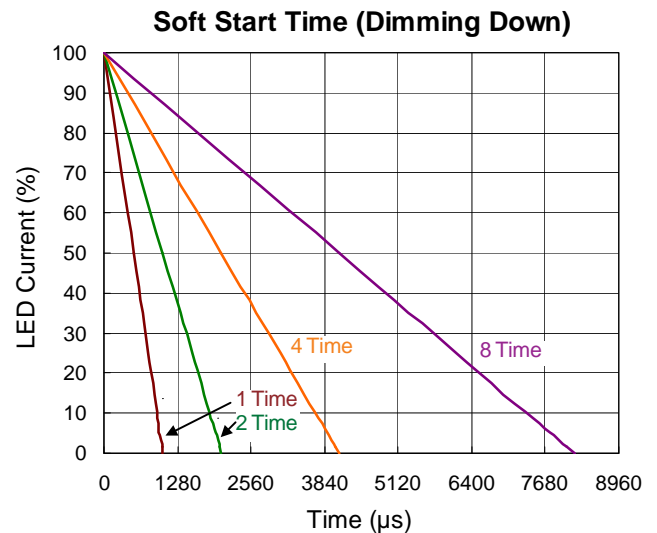

Figure 9. LED Current (Dimming Down) vs. Soft Start Time

**Smart Dither Slope Time Control**

The smart dither slope time control could be set by the I<sup>2</sup>C, it is shown in the Table 16.

**Table 16. Smart Dither Slop Time Control**

Address	Bit	Name	Default Value	Description	Resolution	R/W
08h	[6:4]	Smart Dither Slope Time Control	B000	Slope time control B000 : 7.8ms B001 : 7.8ms B010 : 15.625ms B011 : 31.25ms B100 : 62.5ms B101 : 125ms B110 : 250ms B111 : 500ms	--	R/W
09h	[4:4]	Smart Dither Enable	B1	Smart dither enable B0 : Disable B1 : Enable	--	R/W

Smart dither slope time can be control by address 08h[6:4], there are many difference brightness times that adjust range from 7.8ms to 500ms. When the smart dither slope command is below B000, the slope time that is the dimming duty from 0% to 100% will be kept at 7.8ms. This function can guarantee the highest of slope time is 500ms. The resolution is shown in Table 17.

**Table 17. Smart Dither Resolution**

Time (period T) 10 bit mode	0T~1T	1T~2T	2T~3T	3T~4T	4T~5T	5T~6T	6T~7T
Dimming Duty (%)	0~1.5625%	1.5625%~3.125%	3.125%~6.25%	6.25%~12.5%	12.5%~25%	25%~50%	50%~100%
Resolution (step)	1024	512	512	512	512	512	511
Slope Time Setting 7.8ms	1.114ms	1.114ms	1.114ms	1.114ms	1.114ms	1.114ms	1.114ms

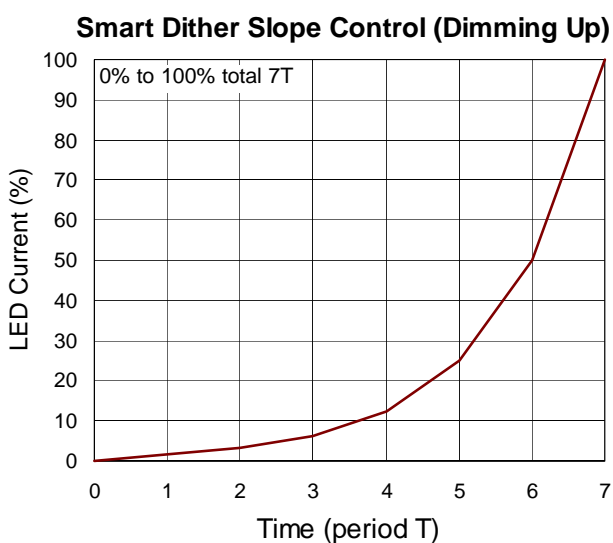

Figure 10. LED Current (Dimming Up) vs. Time

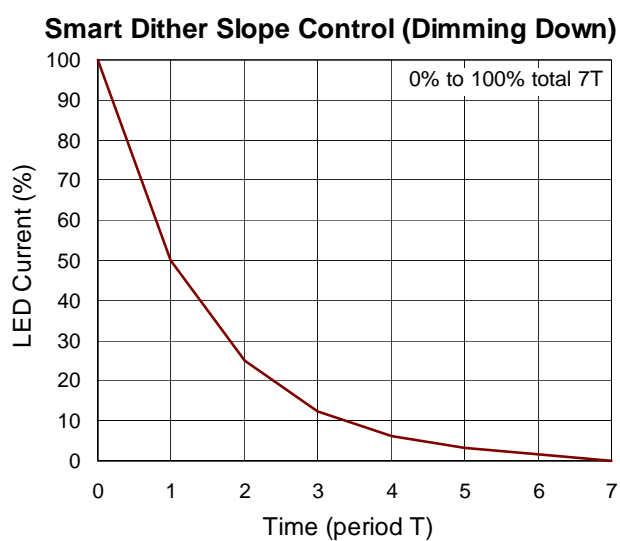

Figure 11. LED Current (Dimming Down) vs. Time

Dither Resolution Control

The dither resolution control could be set by the I<sup>2</sup>C, it is shown in the Table 18.

Table 18. Dither Slop Time Control

Address	Bit	Name	Default Value	Description	Resolution	R/W
09h	[1:0]	Dither Resolution	B00	Dither resolution B00 : 0 bit B01 : 1 bit B10 : 2 bit B11 : 3 bit	--	R/W
09h	[2:2]	PWM Dither Enable	B1	PWM dither enable B0 : Disable B1 : Enable	--	R/W
09h	[3:3]	DC Dither Enable	B1	DC dither enable B0 : Disable B1 : Enable	--	R/W

Dither resolution can be control by address 09h[1:0], there are four kind of dither resolution that are from 0 bit to 3 bit. When the command is below B00, the dither resolution that is the dimming duty from 0% to 100% will be kept at 0 bit. This function can guarantee the highest of dither resolution is 3 bit. The dither resolution is shown in Table 19.

Table 19. Dither Resolution

Resolution (step) x Step Time(μs)	Dimming Duty (%)							
	0~1.5625%	1.5625%~3.125%	3.125%~6.25%	6.25%~12.5%	12.5%~25%	25%~50%	50%~100%	Total Time (μs) (0%~100%)
No DC dither 09h[3:3] = 0	16 x 1μs	16 x 1μs	32 x 1μs	64 x 1μs	128 x 1μs	256 x 1μs	511 x 1μs	1023μs
0bit dither	32 x 16μs	32 x 16μs	64 x 8μs	128 x 4μs	256 x 2μs	512 x 1μs	511 x 1μs	3583μs
1bit dither	64 x 16μs	64 x 16μs	128 x 8μs	256 x 4μs	512 x 2μs	512 x 1μs	511 x 2μs	7166μs
2bit dither	128 x 16μs	128 x 16μs	256 x 8μs	512 x 4μs	512 x 2μs	512 x 1μs	511 x 4μs	14332μs
3bit dither	256 x 16μs	256 x 16μs	512 x 8μs	512 x 4μs	512 x 2μs	512 x 1μs	511 x 8μs	28664μs

Note : Fade Time is 1μs (09h[6:5] = B01)

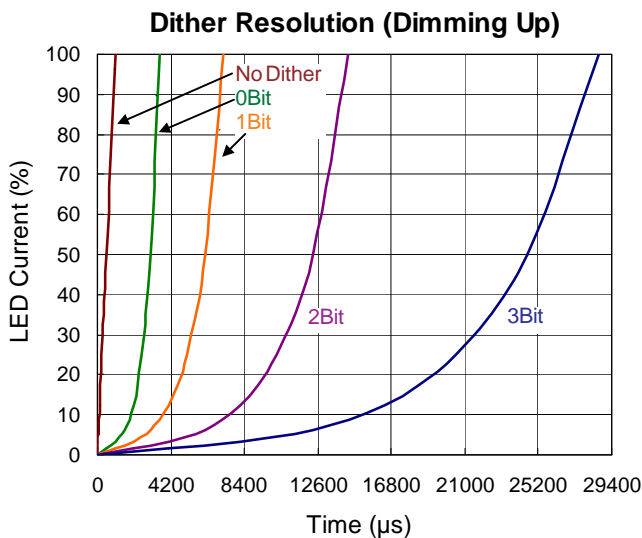

Figuer 12. LED Current (Dimming Up) vs. Time

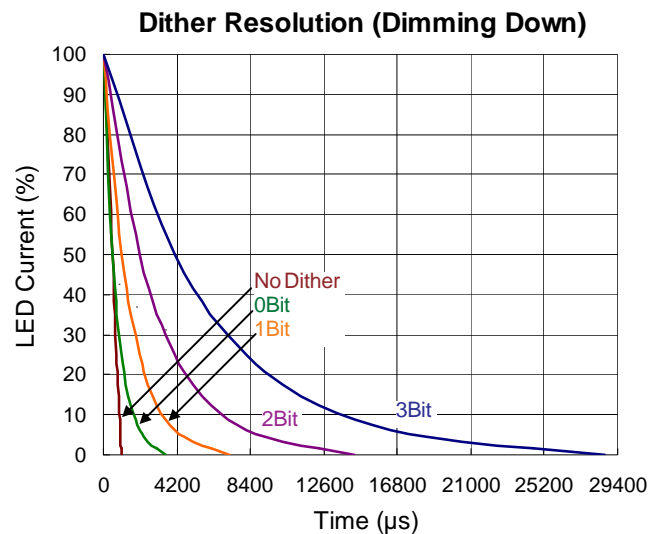

Figuer 13. LED Current (Dimming Down) vs. Time

**26KHz Mode Division Frequency**

The 26KHz mode division frequency could be set by the I<sup>2</sup>C, it is shown in the Table 20.

**Table 20. 26KHz Mode Division Frequency**

Address	Bit	Name	Default Value	Description	Resolution	R/W
0Ah	[7:5]	26KHz mode division frequency	B000	PWMO frequency B000 : 26KHz B001 : 26KHz/2 B010 : 26KHz/4 B011 : 26KHz/8 B1xx : 26KHz/16	--	R/W

The 26kHz mode division frequency can be control by address 0Ah[7:5], there are five kind of division frequency that contain 26KHz, 26KHz/2, 26KHz/4, 26KHz/8 and 26KHz/16. When the command is below B000, the PWMO frequency that is the 26kHz mode will be kept at 26KHz. This function can guarantee the most of division frequency is division 16 time.

**Control CLK PFM Function Enable**

The CLK PFM function enable could be set by the I<sup>2</sup>C, it is shown in the Table 21.

**Table 21. Control CLK PFM Function Enable**

Address	Bit	Name	Default Value	Description	Resolution	R/W
0Dh	[7:7]	Control CLK PFM function enable	B0	Control CLK PFM function enable B0 : off B1 : on	--	R/W

The CLK PFM function enable can be control by address 0Dh[7:7]. If the bit equals to 0, it means the boost switching frequency just depends on the switching frequency setting. Otherwise, if the bit equals to 1, the boost switching frequency will be decreased, when the boost on time is lower than the minimum on time.

**LED Protection**

RT8555 has LED protection for LED OVP level, LED unused. The LED protection could be set by the I<sup>2</sup>C, it is shown in the Table 22.

**Table 22. LED Protection**

Address	Bit	Name	Default Value	Description	Resolution	R/W
0Eh	[3:2]	LED OVP level	B00	LED OVP level B00 : 2.1V B01 : 2.52V B10 : 2.8V B11 : 3.5V	--	R/W
0Eh	[5:5]	LED unused check	B0	LED unused check B0 : Disable B1 : Enable	--	R/W

### LED OVP level

The LED OVP level can be control by address 0Eh[3:2], there are four kind of LED OVP level that is from 2.1V to 3.5V. When the command is below B00, the LED OVP level that is the minimum FBx voltage up to the target level will be kept at 2.1V. This function can guarantee the highest of LED OVP level is 3.5V. When the minimum FBx voltage rises above the LED OVP level setting, the internal switch will be turned off. Once the minimum FBx voltage drops below the LED OVP level setting, the internal switch will be turned on again. The minimum FBx voltage can be clamped at the LED OVP level setting.

### LED unused check

The LED unused check can be control by address 0Eh[5:5]. If the bit equals to 0, it means the function disable. Otherwise, if the bit equals to 1, the function enable, and the internal pulled current of the FBx pin will be turned off. The FBx pin should be connected to GND. This channel is detected as unused channel and latch. If the un-used channel is not connected to GND, and the FBx level is low to 100mV. It means open LED protection.

### LED Connection

The RT8555 equips 6-CH LED drivers and each channel supports up to 10 LEDs. The LED strings are connected from the output of the boost converter to pin FBx (x = 1 to 6) respectively. If one of the current sink channels is not used, the FBx pin should be connected to GND. If the unused channel is not connected to GND, it will be considered that the LED string is opened; the channel will turn light when the LED string is recovering connected.

### Open LED Protection

If the FBx pin voltage is low to 0.1V, the LED driver will judge the channel to be open. The FBx pin voltage will not be regulated and not latch, until the FBx pin is recovery connected, the FBx pin will normal work again. If all FBx pin are open (floating), the output voltage will be clamped to the setting voltage of OVP ( $V_{OUT(OVP)}$ ).

### Over Temperature Protection

The RT8555 has over temperature protection function to prevent the IC from overheating due to excessive power dissipation. The OTP function will shutdown the IC when junction temperature exceeds 150°C (typ.). When junction temperature is cool down to 130°C ( $T_{OTP\_hys} = 20^{\circ}C$ ), the LED driver will return to normal work.

### Inductor Selection

The value of the inductance, L, can be approximated by the following equation, where the transition is from Discontinuous Conduction Mode (DCM) to Continuous Conduction Mode (CCM) :

$$L = \frac{D \times (1-D)^2 \times V_{OUT}}{2 \times f_{OSC} \times I_{OUT}}$$

The duty cycle, D, can be calculated as the following equation :

$$D = \frac{V_{OUT} - V_{IN}}{V_{OUT}}$$

Where  $V_{OUT}$  is the maximum output voltage,  $V_{IN}$  is the minimum input voltage,  $f_{OSC}$  is the operating frequency, and  $I_{OUT}$  is the sum of current from all LED strings. The boost converter operates in DCM over the entire input voltage range when the inductor value is less than this value, L. With an inductance greater than L, the converter operates in CCM at the minimum input voltage and may be discontinuous at higher voltages.

The inductor must be selected with a saturated current rating that is greater than the peak current as provided by the following equation :

$$I_{PEAK} = \frac{V_{OUT} \times I_{OUT}}{\eta \times V_{IN}} + \frac{V_{IN} \times D \times T_{OSC}}{2 \times L}$$

where  $\eta$  is the efficiency of the power converter.

### Diode Selection

Schottky diodes are recommended for most applications because of their fast recovery time and low forward voltage. Power dissipation, reverse voltage rating, and pulsating peak current are important parameters for consideration when making a Schottky diode selection. Make sure that the diode's peak current rating exceeds  $I_{PEAK}$  and reverse voltage rating exceeds the maximum output voltage.

**Input Capacitor Selection**

The ceramic capacitors are recommended for input capacitor applications. Low ESR will effectively reduce the input voltage ripple caused by switching operation. Two 10μF/25V capacitors are sufficient for most applications. Nevertheless, this value can be decreased for lower output current requirement. Another consideration is the voltage rating of the input capacitor must be greater than the maximum input voltage.

**Output Capacitor Selection**

Output ripple voltage is an important index for estimating the performance. This portion consists of two parts, one is the ESR voltage of output capacitor, another part is formed by charging and discharging process of output capacitor. Refer to Figure 14, evaluate ΔV<sub>OUT1</sub> by ideal energy equalization. According to the definition of Q, the Q value can be calculated as following equation :

$$Q = \frac{1}{2} \times \left[ \left( I_{IN} - \frac{1}{2} \Delta I_L - I_{OUT} \right) + \left( I_{IN} - \frac{1}{2} \Delta I_L - I_{OUT} \right) \right] \times \frac{V_{IN}}{V_{OUT}} \times \frac{1}{f_{OSC}} = C_{OUT} \times \Delta V_{OUT1}$$

where f<sub>OSC</sub> is the switching frequency, and ΔI<sub>L</sub> is the inductor ripple current. Move C<sub>OUT</sub> to the left side to estimate the value of ΔV<sub>OUT1</sub> as the following equation :

$$\Delta V_{OUT1} = \frac{D \times I_{OUT}}{\eta \times C_{OUT} \times f_{OSC}}$$

Then, take the ESR into consideration, the ESR voltage can be determined as the following equation :

$$\Delta V_{ESR} = \left( \frac{I_{OUT}}{1-D} + \frac{V_{IN} \times D \times T_{OSC}}{2L} \right) \times R_{ESR}$$

Finally, the total output ripple ΔV<sub>OUT</sub> is combined from the ΔV<sub>OUT1</sub> and ΔV<sub>ESR</sub>. In the general application, the output capacitor is recommended to use a 4.7μF/50V electrolytic capacitor.

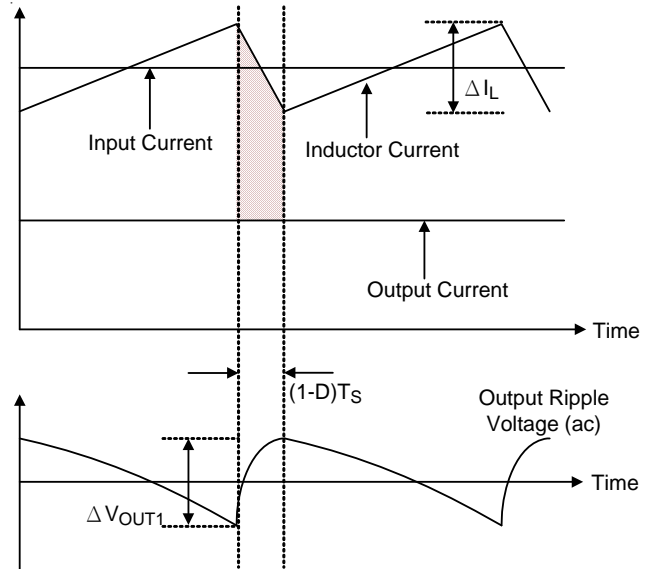

Figure 14. The Output Ripple Voltage without the Contribution of ESR

**Thermal Considerations**

For continuous operation, do not exceed absolute maximum junction temperature. The maximum power dissipation depends on the thermal resistance of the IC package, PCB layout, rate of surrounding airflow, and difference between junction and ambient temperature. The maximum power dissipation can be calculated by the following formula :

$$P_{D(MAX)} = (T_{J(MAX)} - T_A) / \theta_{JA}$$

where T<sub>J(MAX)</sub> is the maximum junction temperature, T<sub>A</sub> is the ambient temperature, and θ<sub>JA</sub> is the junction to ambient thermal resistance.

For recommended operating condition specifications, the maximum junction temperature is 125°C. The junction to ambient thermal resistance, θ<sub>JA</sub>, is layout dependent. For WL-CSP-20B 1.65x2.05 (BSC) package, the thermal resistance, θ<sub>JA</sub>, is 36.7°C/W on a standard JEDEC 51-7 four-layer thermal test board. The maximum power dissipation at T<sub>A</sub> = 25°C can be calculated by the following formula :

$P_{D(MAX)} = (125^{\circ}\text{C} - 25^{\circ}\text{C}) / (36.7^{\circ}\text{C}/\text{W}) = 2.72\text{W}$  for WL-CSP-20B 1.65x2.05 (BSC) package

The maximum power dissipation depends on the operating ambient temperature for fixed  $T_{J(MAX)}$  and thermal resistance,  $\theta_{JA}$ . The derating curve in Figure 15 allows the designer to see the effect of rising ambient temperature on the maximum power dissipation.

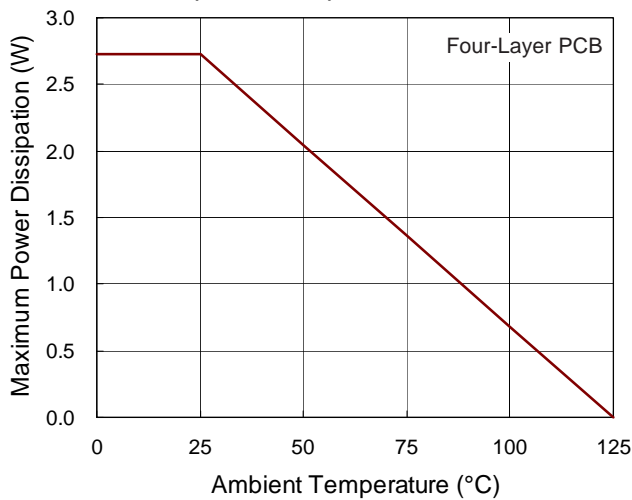

Figure 15. Derating Curve of Maximum Power Dissipation

### Layout Consideration

- ▶ For good regulation, place the power components as close to the IC as possible. The traces should be wide and short, especially for the high current output loop.
- ▶ The input and output bypass capacitor should be placed as close to the IC as possible and connected to the ground plane of the PCB.
- ▶ Minimize the size of the L nodes and keep traces wide and short. Care should be taken to avoid running traces that carry any noise-sensitive signals near LX or high-current traces.
- ▶ Separate power ground (PGND) and ground (GND). Connect the GND and the PGND islands at a single end. Make sure that there are no other connections between these separate ground planes.
- ▶ Connect the exposed pad to a strong ground plane for maximum thermal dissipation.

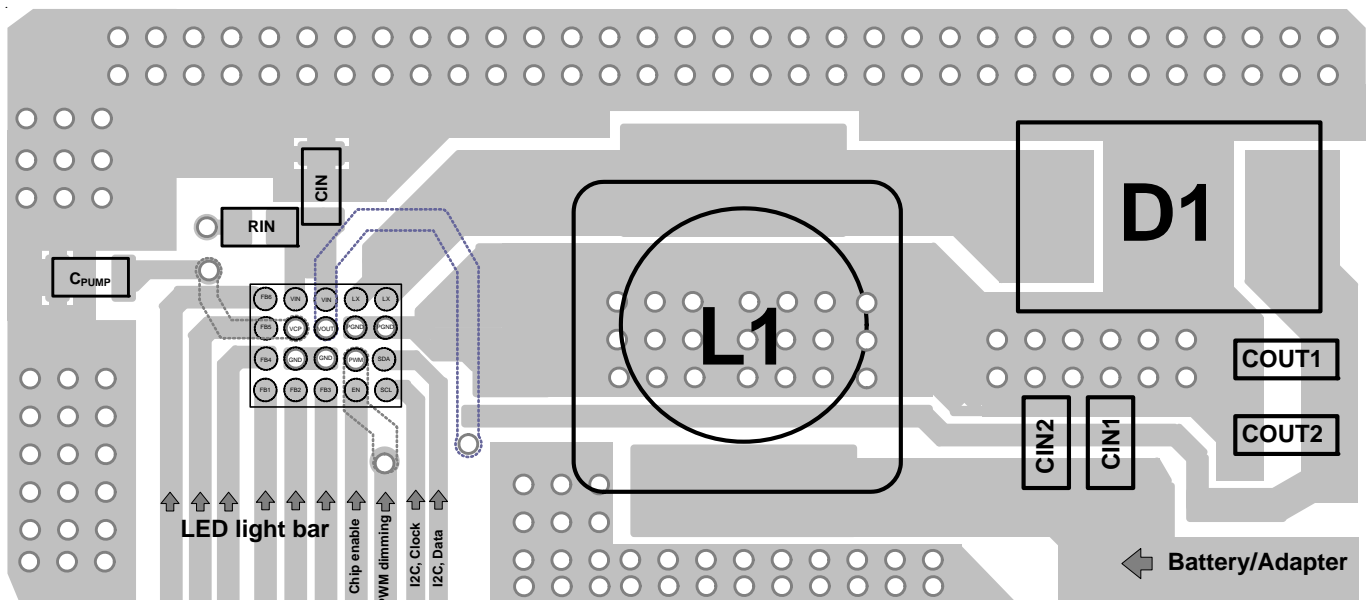
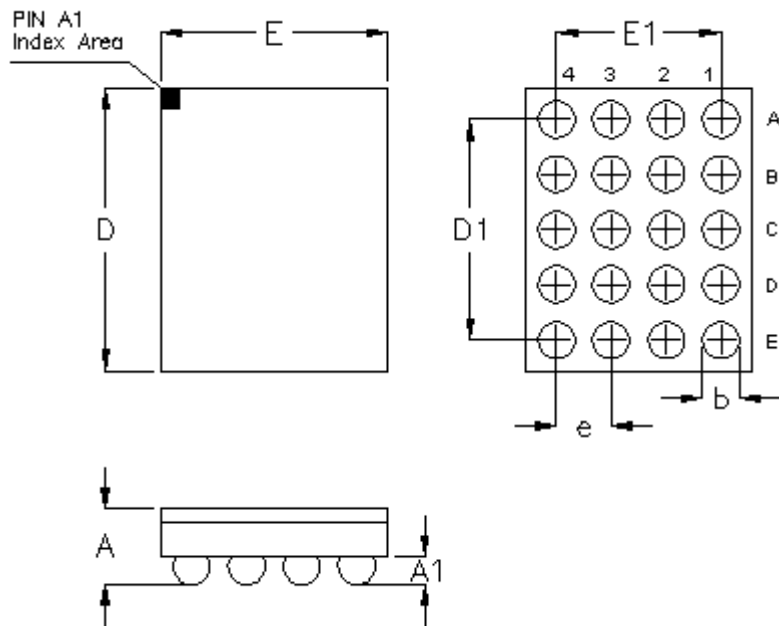

Figure 16. PCB Layout Guide



**Outline Dimension**



Symbol	Dimensions In Millimeters		Dimensions In Inches	
	Min.	Max.	Min.	Max.
A	0.500	0.600	0.020	0.024
A1	0.170	0.230	0.007	0.009
b	0.220	0.280	0.009	0.011
D	2.000	2.100	0.079	0.083
D1	1.600		0.063	
E	1.600	1.700	0.063	0.067
E1	1.200		0.047	
e	0.400		0.016	

**20B WL-CSP 1.65x2.05 Package (BSC)**

**Richtek Technology Corporation**

14F, No. 8, Tai Yuen 1<sup>st</sup> Street, Chupei City  
 Hsinchu, Taiwan, R.O.C.  
 Tel: (8863)5526789

Richtek products are sold by description only. Richtek reserves the right to change the circuitry and/or specifications without notice at any time. Customers should obtain the latest relevant information and data sheets before placing orders and should verify that such information is current and complete. Richtek cannot assume responsibility for use of any circuitry other than circuitry entirely embodied in a Richtek product. Information furnished by Richtek is believed to be accurate and reliable. However, no responsibility is assumed by Richtek or its subsidiaries for its use; nor for any infringements of patents or other rights of third parties which may result from its use. No license is granted by implication or otherwise under any patent or patent rights of Richtek or its subsidiaries.

## X-ON Electronics

Largest Supplier of Electrical and Electronic Components

*Click to view similar products for [Richtek](#) manufacturer:*

Other Similar products are found below :

[EVB\\_RT5047GSP](#) [EVB\\_RT7275GQW](#) [EVB\\_RT7297CHZSP](#) [RT9080N-08GJ5](#) [EVB\\_RT5047AGSP](#) [EVB\\_RT7243GQW](#)  
[EVB\\_RT7272BGSP](#) [RT8097AHGE](#) [EVB\\_RT7247CHGSP](#) [EVB\\_RT7276GQW](#) [EVB\\_RT8293AHZSP](#) [EVB\\_RT6200GE](#)  
[EVB\\_RT7235GQW](#) [EVB\\_RT7237AHGSP](#) [EVB\\_RT7251AZQW](#) [RT5047AGSP](#) [EVB\\_RT7272AGSP](#) [EVB\\_RT7237CHGSP](#)  
[EVB\\_RT7247AHGSP](#) [EVB\\_RT7252BZSP](#) [EVB\\_RT7280GQW](#) [EVB\\_RT8292AHZSP](#) [EVB\\_RT8297BZQW](#) [EVB\\_RT7231GQW](#)  
[EVB\\_RT7232GQW](#) [EVB\\_RT7236GQW](#) [EVB\\_RT7250BZSP](#) [EVB\\_RT7251BZQW](#) [EVB\\_RT7279GQW](#) [EVB\\_RT8008GB](#) [RT8207MZQW](#)  
[RT8296AHZSP](#) [RT9011-JGPJ6](#) [RT8258GE](#) [RT5711AHGQW](#) [RT9081AGQZA\(2\)](#) [RT6154BGQW](#) [RT7238BGQUF](#) [RT5788AGJ8F](#)  
[RT8812AGQW](#) [RT6278BHGQUF](#) [RT7270HZSP](#) [RD0004](#) [RT5789AGQUF](#) [RT9076-18GVN](#) [RT9193-15GU5](#) [RT3602AJGQW](#)  
[RT8296BHZSP](#) [RT6214AHGJ6F](#) [RT9276GQW\(Z00\)](#)