

2.25MHz 600mA Synchronous Step-Down Converter

General Description

The RT2657 is a high efficiency Pulse-Width-Modulated (PWM) step-down DC/DC converter, capable of delivering 600mA output current over a wide input voltage range from 2.7V to 5.5V. The RT2657 is ideally suited for portable electronic devices that are powered from 1-cell Li-ion battery or from other power sources such as cellular phones, PDAs, hand-held devices, game console and related accessories.

The internal synchronous rectifier with low $R_{DS(ON)}$ dramatically reduces conduction loss at PWM mode. No external Schottky diode is required in practical applications. The RT2657 enters Low Dropout Mode when normal Pulse-Width Mode cannot provide regulated output voltage by continuously turning on the upper P-MOSFET. The RT2657 enters shut-down mode and consumes less than 5 μ A when the EN pin is pulled low. The switching ripple is easily smoothed-out by small package filtering elements due to a fixed operating frequency of 2.25MHz.

The RT2657 is available in the small WDFN-6SL 2x2 package.

Marking Information

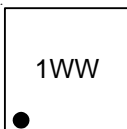

1W : Product Code
W : Date Code

Features

- V_{IN} Range 2.7V to 5.5V
- V_{OUT} Range 0.6V to 5.5V (100% Duty Ratio Operation)
- $V_{REF} = 0.6V$
- $I_{SD} \leq 5\mu A$ ($V_{EN} = 0V$)
- Current Mode Control, Internal Compensation
- Fixed F_{SW} 2.25MHz
- $R_{DS(ON)}$ 230m Ω HS/250m Ω LS (P-MOSFET/ N-MOSFET)
- Enable ($V_{IH} = 1V$, $V_{IL} = 0.4V$); Int. Soft-Start (0.3ms)
- Up to 600mA Output Current
- Up to 90% Efficiency
- Peak I_{LIMIT} (1.5A Typical / 0.8A Min); UVLO; UVP; V_{IN} and V_{OUT} OVP; and OTP (150°C)
- No Schottky Diode Required
- Internal Compensation to Reduce External Components
- RoHS Compliant and Halogen Free

Applications

- Portable Instruments
- Game Console and Accessories
- Microprocessors and DSP Core Supplies
- Cellular Phones
- Wireless and DSL Modems
- PC Cards
- Automotive InfoTainMent

Simplified Application Circuit

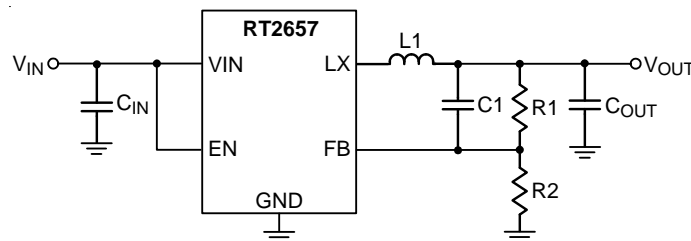

Ordering Information

RT2657 □□ (2)

- └─ Taping Type (Pin1 at Q2)
- └─ Package Type
QW : WDFN-6SL 2x2 (W-Type)
- └─ Lead Plating System
G : Green (Halogen Free and Pb Free)

Note :

Richtek products are :

- ▶ RoHS compliant and compatible with the current requirements of IPC/JEDEC J-STD-020.
- ▶ Suitable for use in SnPb or Pb-free soldering processes.

Pin Configurations

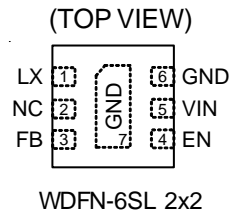

Function Pin Description

Pin No.	Pin Name	Pin Function
1	LX	Switch Node. Connect to the external inductor.
2	NC	No Internal Connection. Connect to GND.
3	FB	Feedback Voltage Input. Connect to the external resistor divider.
4	EN	Enable Control Input (Active High).
5	VIN	Power Input. Connect to the input capacitor.
6, 7 (Exposed Pad)	GND	Power GND. The Exposed Pad must be soldered to a large PCB and connected to GND for maximum power dissipation.

Function Block Diagram

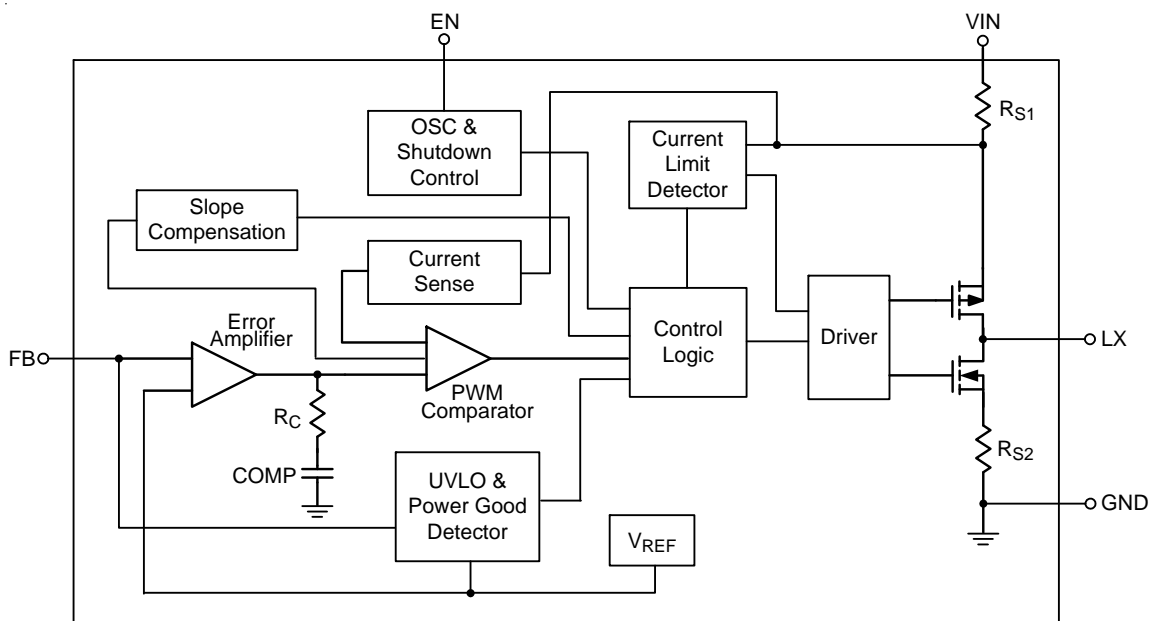

Operation

The RT2657 is a synchronous low voltage Buck Converter that can support the input voltage range from 2.7V to 5.5V and the output current can be up to 0.6A. The RT2657 uses a constant frequency, current mode architecture. In normal operation, the high-side P-MOSFET is turned on when the Switch Controller is set by the oscillator (OSC) and is turned off when the current comparator resets the Switch Controller.

The high-side MOSFET peak current is measured by internal R_{SENSE} . The current signal is where Slope Compensator works together with sensing voltage of R_{SENSE} . The error amplifier EA adjusts COMP voltage by comparing the feedback signal (V_{FB}) from the output voltage with the internal 0.6V reference. When the load current increases, it causes a drop in the feedback voltage relative to the reference. The COMP voltage then rises to allow higher inductor current to match the load current.

UV Comparator

If the feedback voltage (V_{FB}) is lower than threshold voltage 0.2V, the UV Comparator's output will go high and the Switch Controller will turn off the high-side MOSFET.

Oscillator (OSC)

The internal oscillator runs at 2.25MHz.

Enable Comparator

The EN pin can be connected to VIN through a 100k Ω resistor for automatic startup.

Soft-Start (SS)

An internal current source (25nA) charges an internal capacitor (15pF) to build the soft-start ramp voltage (V_{SS}). The V_{FB} voltage will track the internal ramp voltage during soft-start interval. The typical soft-start time is 300 μ s.

Absolute Maximum Ratings (Note 1)

- Supply Input Voltage, V_{IN} ----- -0.3V to 6.5V
- Switch Voltage, LX ----- -0.3V to ($V_{IN} + 0.3V$)
- All Other Pins ----- -0.3V to 6V
- Power Dissipation, P_D @ $T_A = 25^\circ C$
 WDFN-6SL 2x2 ----- 0.833W
- Package Thermal Resistance (Note 2)
 WDFN-6SL 2x2, θ_{JA} ----- $120^\circ C/W$
 WDFN-6SL 2x2, θ_{JC} ----- $12^\circ C/W$
- Lead Temperature (Soldering, 10 sec.) ----- $260^\circ C$
- Junction Temperature ----- $150^\circ C$
- Storage Temperature Range ----- $-65^\circ C$ to $150^\circ C$
- ESD Susceptibility (Note 3)
 HBM (Human Body Model) ----- 2kV

Recommended Operating Conditions (Note 4)

- Supply Input Voltage, V_{IN} ----- 2.7V to 5.5V
- Junction Temperature Range ----- $-40^\circ C$ to $125^\circ C$
- Ambient Temperature Range ----- $-40^\circ C$ to $85^\circ C$

Electrical Characteristics

($V_{IN} = 3.6V$, $T_A = -40^\circ C$ to $85^\circ C$ unless otherwise specified)

Parameter	Symbol	Test Conditions	Min	Typ	Max	Unit	
Output Current	I_{OUT}	$V_{IN} = 2.7V$ to $5.5V$	--	--	0.6	A	
Quiescent Current	I_Q	$V_{EN} = 1V$, $V_{FB} = 0.5V$	--	300	--	μA	
Feedback Voltage	V_{FB}	$V_{IN} = 2.7V$ to $5.5V$ @ $T_A = 25^\circ C$	588	600	612	mV	
		$V_{IN} = 2.7V$ to $5.5V$	585	600	615		
Under-Voltage Lockout Threshold	V_{UVLO}	V_{IN} Rising	1.85	2.2	2.55	V	
		Hysteresis	--	0.2	--	V	
Shutdown Current	I_{SHDN}	$V_{EN} = 0V$	--	--	5	μA	
Switching Frequency			--	2.25	--	MHz	
EN Input Voltage	Logic-High	V_{IH}	1	--	V_{IN}	V	
	Logic-Low	V_{IL}	--	--	0.4	V	
Thermal Shutdown Temperature	T_{SD}		--	150	--	$^\circ C$	
Switch On-Resistance	High-Side	$R_{DS(ON)_H}$	$I_{SW} = 0.2A$	--	230	--	$m\Omega$
	Low-Side	$R_{DS(ON)_L}$	$I_{SW} = 0.2A$	--	250	--	$m\Omega$
Peak Current Limit	I_{LIM}		0.8	1.5	--	A	
Output Voltage Load Regulation		$0mA < I_{OUT} < 0.6A$	--	1	--	%	

Note 1. Stresses beyond those listed “Absolute Maximum Ratings” may cause permanent damage to the device. These are stress ratings only, and functional operation of the device at these or any other conditions beyond those indicated in the operational sections of the specifications is not implied. Exposure to absolute maximum rating conditions may affect device reliability.

Note 2. θ_{JA} is measured at $T_A = 25^\circ\text{C}$ on a high effective thermal conductivity four-layer test board per JEDEC 51-7.

Note 3. Devices are ESD sensitive. Handling precaution is recommended.

Note 4. The device is not guaranteed to function outside its operating conditions.

Typical Application Circuit

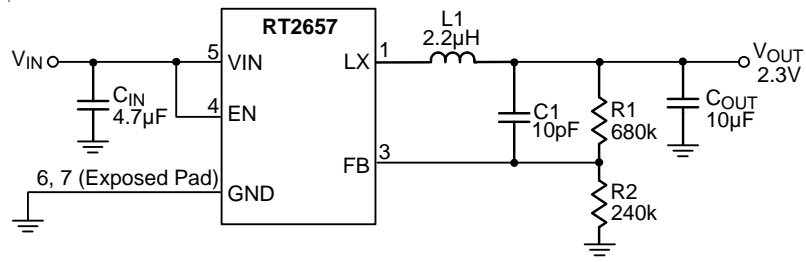

Typical Operating Characteristics

Efficiency vs. Output Current

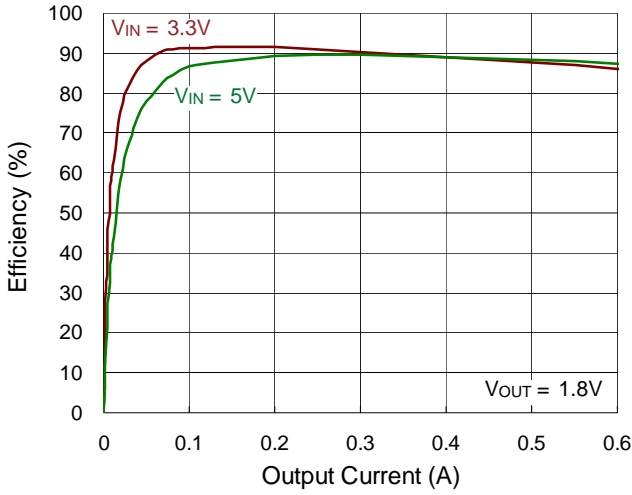

Output Voltage vs. Input Voltage

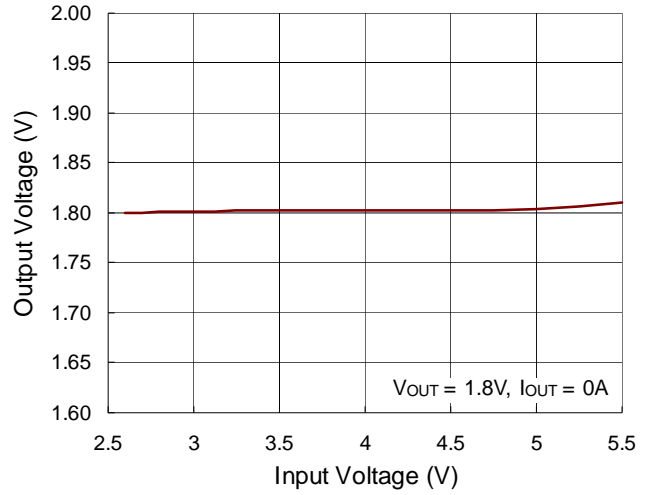

Frequency vs. Input Voltage

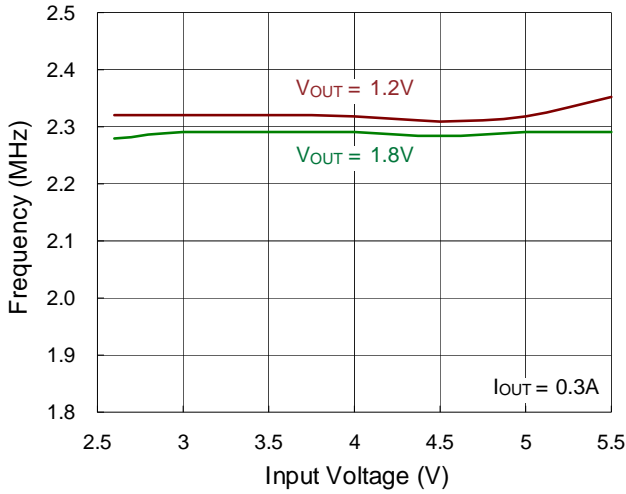

Frequency vs. Temperature

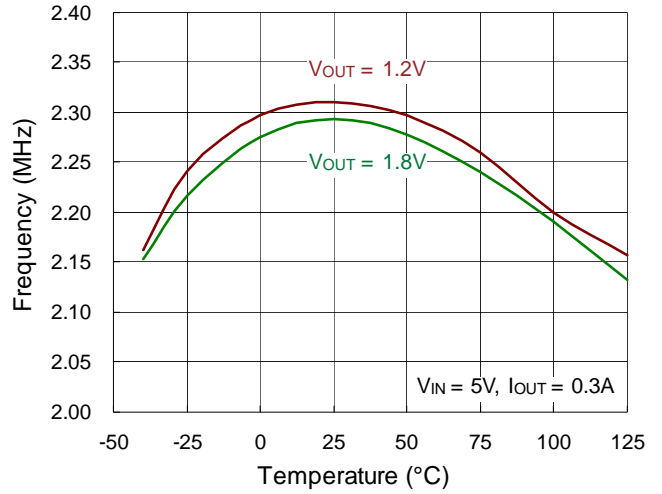

Output Current Limit vs. Input Voltage

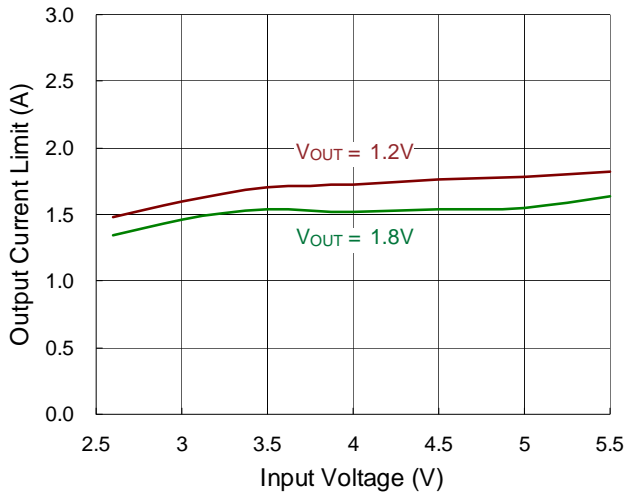

Output Current Limit vs. Temperature

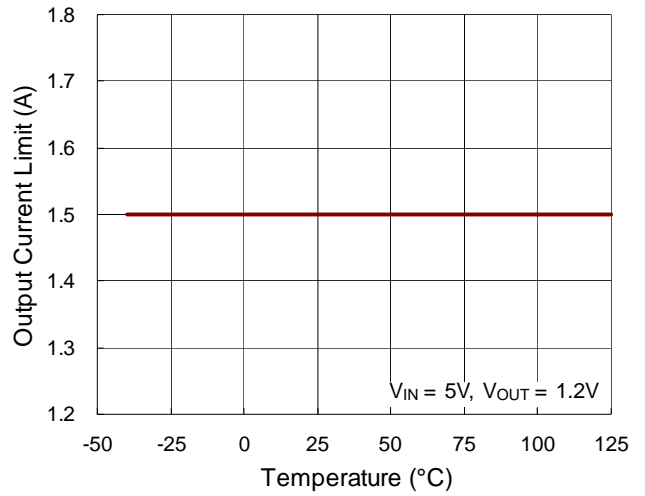

Output Voltage vs. Temperature

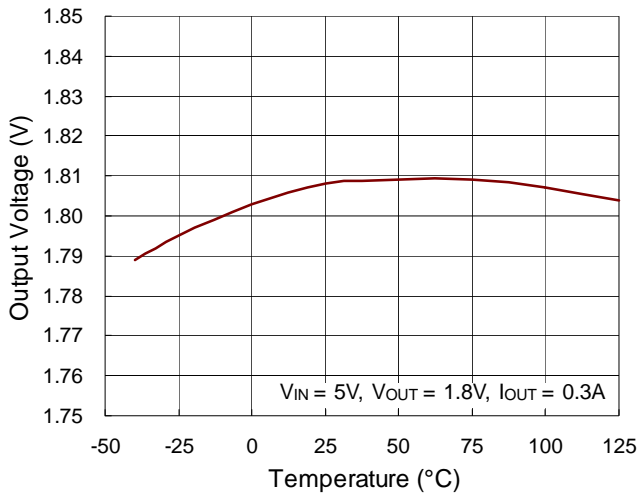

V_{FB} vs. Temperature

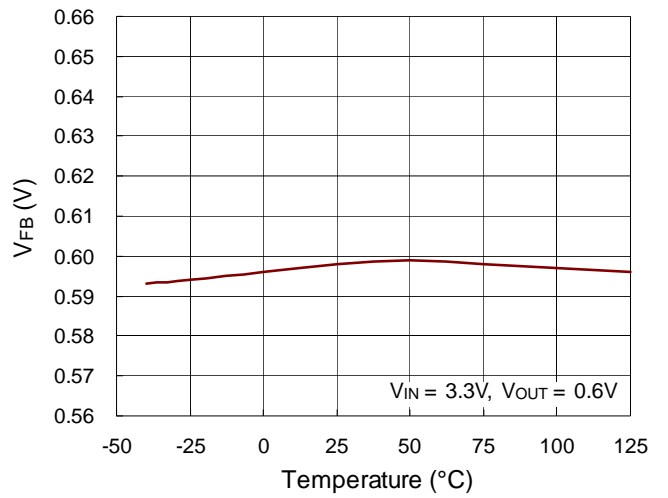

Output Ripple

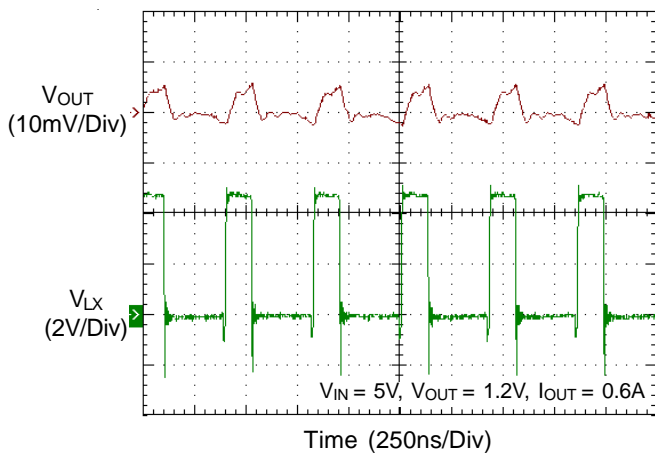

Output Ripple

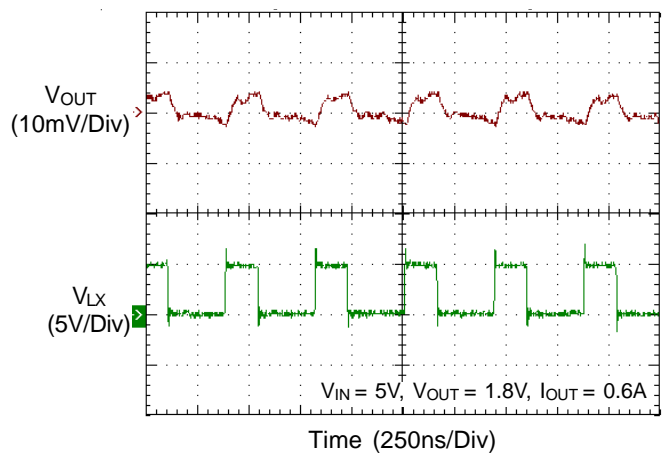

Load Transient Response

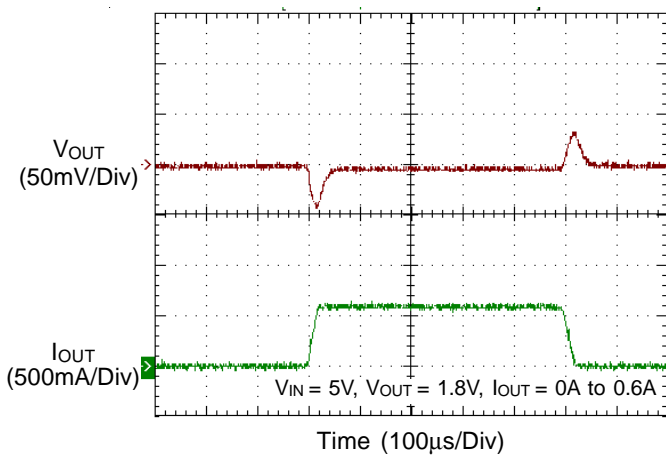

Load Transient Response

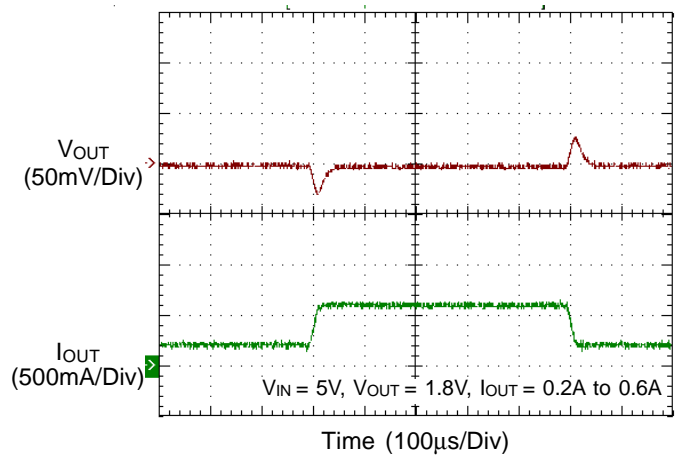

Power On from EN

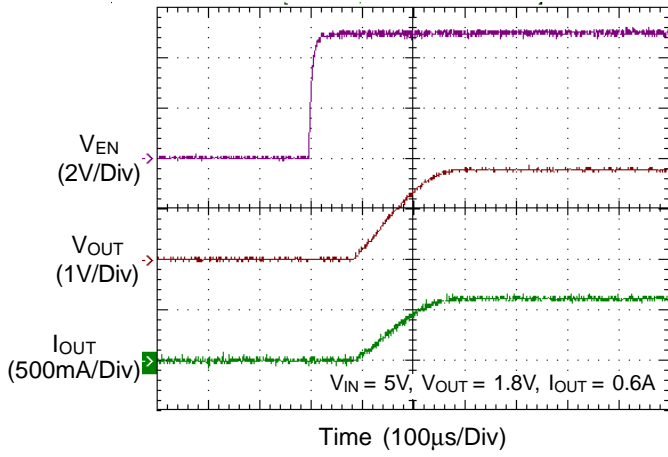

Power Off from EN

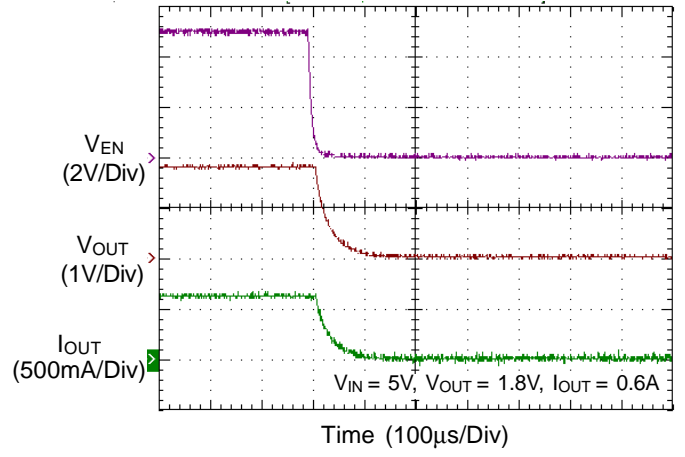

UVLO vs. Temperature

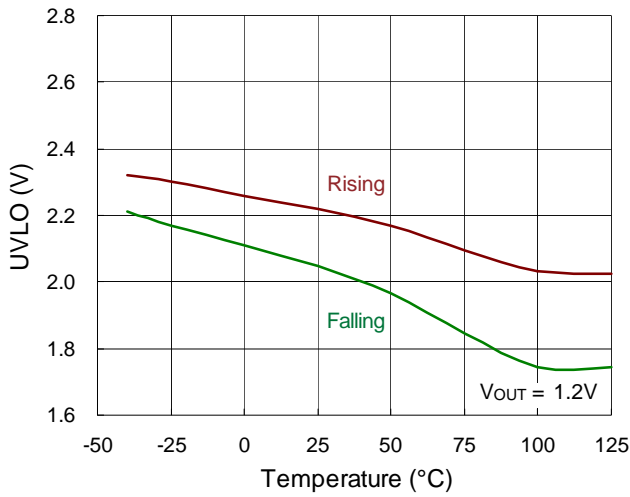

EN Threshold vs. Temperature

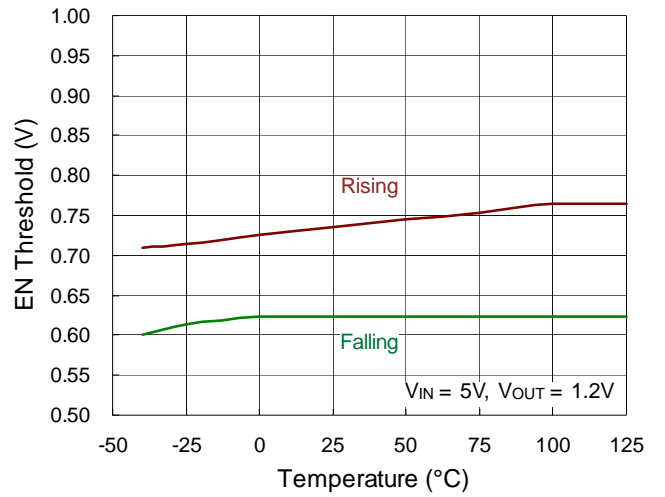

Application Information

The basic RT2657 application circuit is shown in Typical Application Circuit. External component selection is determined by the maximum load current and begins with the selection of the inductor value and operating frequency followed by C_{IN} and C_{OUT}.

Output Voltage Setting

The output voltage is set by an external resistive divider according to the following equation :

$$V_{OUT} = V_{REF} \times \left(1 + \frac{R1}{R2}\right)$$

where V_{REF} equals to 0.6V typically. The resistive divider allows the FB pin to sense a fraction of the output voltage as shown in Figure 1.

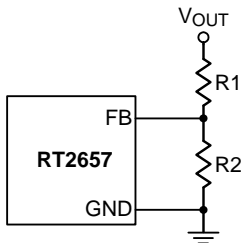

Figure 1. Setting the Output Voltage

Soft-Start

The RT2657 contains an internal soft-start clamp that gradually raises the clamp on the FB pin. Time from active EN to reach 95% of V_{OUT} nominal is within typical 300µs.

100% Duty Cycle Operation

When the input supply voltage decreases toward the output voltage, the duty cycle increases toward the maximum on-time. Further reduction of the supply voltage forces the main switch to remain on for more than one cycle, eventually reaching 100% duty cycle.

The output voltage will then be determined by the input voltage minus the voltage drop across the internal P-MOSFET and the inductor.

Low Supply Operation

The RT2657 is designed to operate down to an input supply voltage of 2.7V. One important consideration at low input supply voltages is that the R_{DS(ON)} of the P-Channel and N-Channel power switches increases. Users should calculate the power dissipation when the RT2657 is used at 100% duty cycle with low input voltages to ensure that thermal limits are not exceeded.

Under-Voltage Protection (UVP)

The output voltage is continuously monitored for under-voltage protection. When the output voltage is less than 33% of its set voltage threshold after OCP occurs, the under-voltage protection circuit will be triggered to auto re-softstart.

Input Over-Voltage protection (V_{IN} OVP)

When the input voltage (V_{IN}) is higher than 6V, V_{IN} OVP will be triggered and the IC stops switching. Once the input voltage drops below 6V, the IC will return to normal operation.

Output Over-Voltage Protection (V_{OUT} OVP)

When the output voltage exceeds more than 5% of the nominal reference voltage, the feedback loop forces the internal switches off within 50µs. Therefore, the output over-voltage protection is automatically triggered by the loop.

Short Circuit Protection

When the output is shorted to ground, the inductor current decays very slowly during a single switching cycle. A current runaway detector is used to monitor inductor current. As current increases beyond the control of current loop, switching cycles will be skipped to prevent current runaway from occurring.

Table 1. Inductors

Component Supplier	Series	Inductance (µH)	DCR (mΩ)	Current Rating (mA)	Dimensions (mm)
TAIYO YUDEN	NR5018 T2R2M	2.2µH	40	3000	4 X 4 X 1.8

C_{IN} and C_{OUT} Selection

The input capacitance, C_{IN}, is needed to filter the trapezoidal current at the Source of the high-side MOSFET. To prevent large ripple voltage, a low ESR input capacitor sized for the maximum RMS current should be used. RMS current is given by :

$$I_{RMS} = I_{OUT(MAX)} \frac{V_{OUT}}{V_{IN}} \sqrt{\frac{V_{IN}}{V_{OUT}} - 1}$$

This formula has a maximum at V_{IN} = 2V_{OUT}, where I_{RMS} = I_{OUT}/2. This simple worst case condition is commonly used for design because even significant deviations do not result in much difference. Choose a capacitor rated at a higher temperature than required.

Several capacitors may also be paralleled to meet size or height requirements in the design.

The selection of C_{OUT} is determined by the effective series resistance (ESR) that is required to minimize voltage ripple and load step transients, as well as the amount of bulk capacitance that is necessary to ensure the control loop is stable. Loop stability can be checked by viewing the load transient response. The output ripple, ΔV_{OUT}, is determined by :

$$\Delta V_{OUT} \leq \Delta I_L \left[ESR + \frac{1}{8fC_{OUT}} \right]$$

The output ripple is highest at maximum input voltage since ΔI_L increases with input voltage. Multiple capacitors placed in parallel may be needed to meet the ESR and

RMS current handling requirements. Dry tantalum, special polymer, aluminum electrolytic and ceramic capacitors are all available in surface mount packages. Special polymer capacitors offer very low ESR, but have lower capacitance density than other types. Tantalum capacitors have the highest capacitance density, but it is important to only use types that have been surge tested for use in switching power supplies. Aluminum electrolytic capacitors have significantly higher ESR, but can be used in cost-sensitive applications provided that consideration is given to ripple current ratings and long term reliability. Ceramic capacitors have excellent low ESR characteristics, but can have a high voltage coefficient and audible piezoelectric effects.

The high Q of ceramic capacitors with trace inductance can also lead to significant ringing.

Using Ceramic Input and Output Capacitors

Higher value, lower cost ceramic capacitors are now becoming available in smaller case sizes. Their high ripple current, high voltage rating and low ESR make them ideal for switching regulator applications. However, care must be taken when these capacitors are used at the input and output. When a ceramic capacitor is used at the input and the power is supplied by a wall adapter through long wires, a load step at the output can induce ringing at the input, V_{IN}. At best, this ringing can couple to the output and be mistaken as loop instability. At worst, a sudden inrush current through the long wires can potentially cause a voltage spike at V_{IN} large enough to damage the part.

Table 2. Capacitors for C_{IN} and C_{OUT}

Component Supplier	Part No.	Capacitance (μF)	Case Size
MuRata	GRM31CR71A475KA01	4.7μF	1206
MuRata	GRM31CR71A106KA01	10μF	1206

Thermal Considerations

For continuous operation, do not exceed absolute maximum junction temperature. The maximum power dissipation depends on the thermal resistance of the IC package, PCB layout, rate of surrounding airflow, and difference between junction and ambient temperature. The maximum power dissipation can be calculated by the following formula :

$$P_{D(MAX)} = (T_{J(MAX)} - T_A) / \theta_{JA}$$

where $T_{J(MAX)}$ is the maximum junction temperature, T_A is the ambient temperature, and θ_{JA} is the junction to ambient thermal resistance.

For recommended operating condition specifications of the RT2657, the maximum junction temperature is 125°C and T_A is the ambient temperature. The junction to ambient thermal resistance, θ_{JA} , is layout dependent. For WDFN-6SL 2x2 packages, the thermal resistance, θ_{JA} , is 120°C/W on a standard JEDEC 51-7 four-layer thermal test board. The maximum power dissipation at $T_A = 25^\circ\text{C}$ can be calculated by the following formula :

$$P_{D(MAX)} = (125^\circ\text{C} - 25^\circ\text{C}) / (120^\circ\text{C}/\text{W}) = 0.833\text{W for WDFN-6SL 2x2 package}$$

The maximum power dissipation depends on the operating ambient temperature for fixed $T_{J(MAX)}$ and thermal resistance, θ_{JA} . The derating curve in Figure 2 allows the designer to see the effect of rising ambient temperature on the maximum power dissipation.

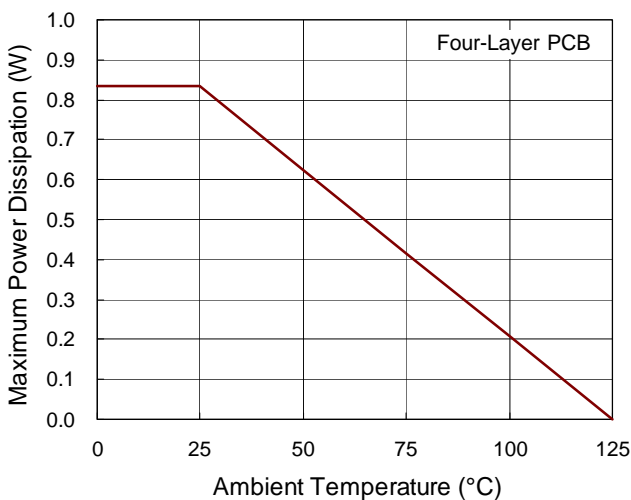

Figure 2. Derating Curve of Maximum Power Dissipation

Layout Considerations

Follow the PCB layout guidelines for optimal performance of the RT2657.

- ▶ Connect the terminal of the input capacitor(s), C_{IN} , as close as possible to the V_{IN} pin. This capacitor provides the AC current into the internal power MOSFETs.
- ▶ LX node experiences high frequency voltage swing and should be kept within a small area. Keep all sensitive small-signal nodes away from the LX node to prevent stray capacitive noise pick up.
- ▶ Flood all unused areas on all layers with copper. Flooding with copper will reduce the temperature rise of power components. Connect the copper areas to any DC net (V_{IN} , V_{OUT} , GND, or any other DC rail in the system).
- ▶ Connect the FB pin directly to the feedback resistors. The resistive voltage divider must be connected between V_{OUT} and GND.

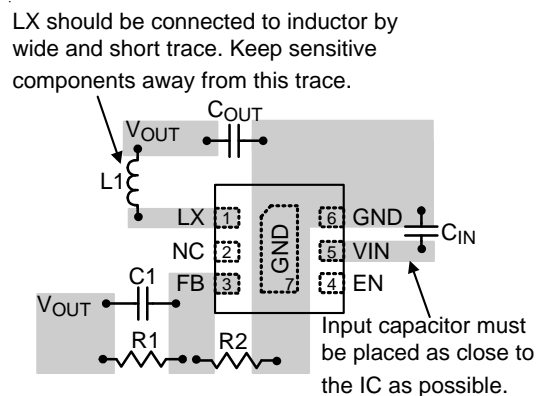
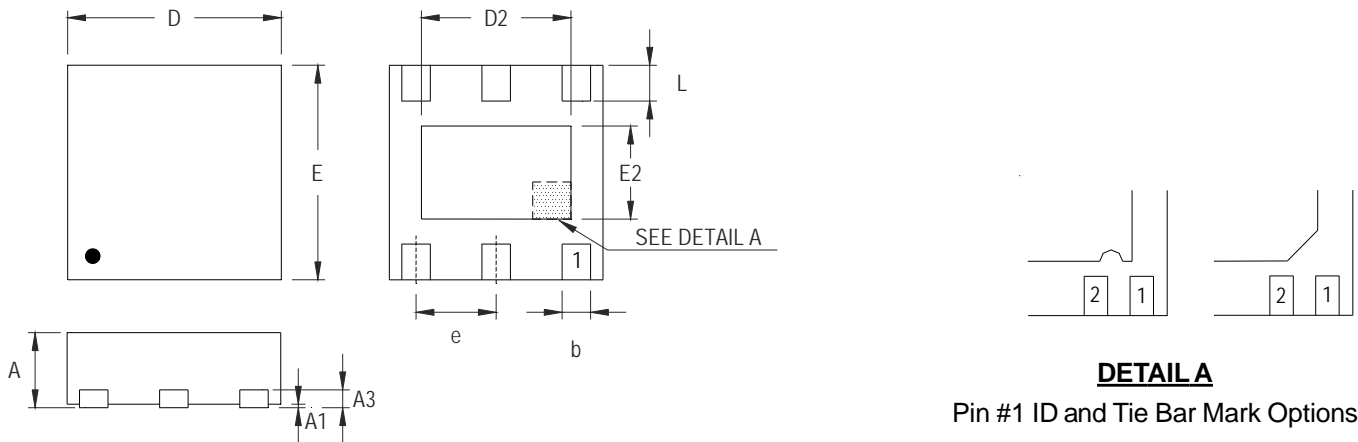

Figure 3. PCB Layout Guide

Outline Dimension



DETAIL A

Pin #1 ID and Tie Bar Mark Options

Note : The configuration of the Pin #1 identifier is optional, but must be located within the zone indicated.

Symbol	Dimensions In Millimeters		Dimensions In Inches	
	Min	Max	Min	Max
A	0.700	0.800	0.028	0.031
A1	0.000	0.050	0.000	0.002
A3	0.175	0.250	0.007	0.010
b	0.200	0.350	0.008	0.014
D	1.900	2.100	0.075	0.083
D2	1.550	1.650	0.061	0.065
E	1.900	2.100	0.075	0.083
E2	0.950	1.050	0.037	0.041
e	0.650		0.026	
L	0.200	0.300	0.008	0.012

W-Type 6SL DFN 2x2 Package

Richtek Technology Corporation

14F, No. 8, Tai Yuen 1st Street, Chupei City
 Hsinchu, Taiwan, R.O.C.
 Tel: (8863)5526789

Richtek products are sold by description only. Richtek reserves the right to change the circuitry and/or specifications without notice at any time. Customers should obtain the latest relevant information and data sheets before placing orders and should verify that such information is current and complete. Richtek cannot assume responsibility for use of any circuitry other than circuitry entirely embodied in a Richtek product. Information furnished by Richtek is believed to be accurate and reliable. However, no responsibility is assumed by Richtek or its subsidiaries for its use; nor for any infringements of patents or other rights of third parties which may result from its use. No license is granted by implication or otherwise under any patent or patent rights of Richtek or its subsidiaries.

X-ON Electronics

Largest Supplier of Electrical and Electronic Components

Click to view similar products for [Richtek](#) manufacturer:

Other Similar products are found below :

[EVB_RT5047GSP](#) [EVB_RT7275GQW](#) [EVB_RT7297CHZSP](#) [RT9080N-08GJ5](#) [EVB_RT5047AGSP](#) [EVB_RT7243GQW](#)
[EVB_RT7272BGSP](#) [RT8097AHGE](#) [EVB_RT7247CHGSP](#) [EVB_RT7276GQW](#) [EVB_RT8293AHZSP](#) [EVB_RT6200GE](#)
[EVB_RT7235GQW](#) [EVB_RT7237AHGSP](#) [EVB_RT7251AZQW](#) [RT5047AGSP](#) [EVB_RT7272AGSP](#) [EVB_RT7237CHGSP](#)
[EVB_RT7247AHGSP](#) [EVB_RT7252BZSP](#) [EVB_RT7280GQW](#) [EVB_RT8292AHZSP](#) [EVB_RT8297BZQW](#) [EVB_RT7231GQW](#)
[EVB_RT7232GQW](#) [EVB_RT7236GQW](#) [EVB_RT7250BZSP](#) [EVB_RT7251BZQW](#) [EVB_RT7279GQW](#) [EVB_RT8008GB](#) [RT8207MZQW](#)
[RT8296AHZSP](#) [RT9011-JGPJ6](#) [RT8258GE](#) [RT5711AHGQW](#) [RT9081AGQZA\(2\)](#) [RT6154BGQW](#) [RT7238BGQUF](#) [RT5788AGJ8F](#)
[RT8812AGQW](#) [RT6278BHGQUF](#) [RT7270HZSP](#) [RD0004](#) [RT5789AGQUF](#) [RT9076-18GVN](#) [RT9193-15GU5](#) [RT3602AJGQW](#)
[RT8296BHZSP](#) [RT6214AHGJ6F](#) [RT9276GQW\(Z00\)](#)