

## 2A, 1MHz, 6V CMCOT Synchronous Step-Down Converter

### General Description

The RT8097B is a high efficiency synchronous step-down DC/DC converter. Its input voltage range is from 2.7V to 6V and provides an adjustable regulated output voltage from 0.6V to 3.4V while delivering up to 2A of output current.

The internal synchronous low on-resistance power switches increase efficiency and eliminate the need for an external Schottky diode. The Current Mode Constant-On-time (CMCOT) operation with internal compensation allows the transient response to be optimized over a wide range of loads and output capacitors. The RT8097B is available in the SOT-23-5/6 package.

### Ordering Information

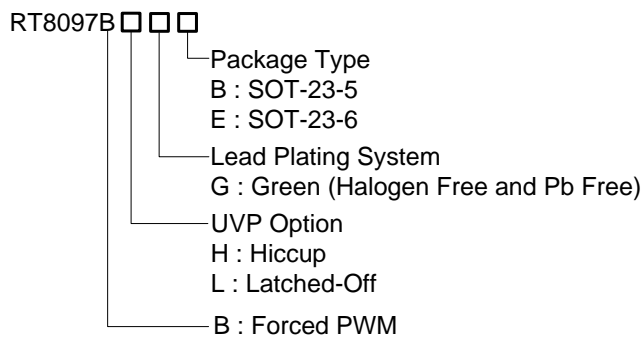

Note :

Richtek products are :

- ▶ RoHS compliant and compatible with the current requirements of IPC/JEDEC J-STD-020.
- ▶ Suitable for use in SnPb or Pb-free soldering processes.

### Features

- Efficiency Up to 95%
- R<sub>DS(on)</sub> 100mΩ HS / 70mΩ LS
- V<sub>IN</sub> Range 2.7V to 6V
- V<sub>REF</sub> 0.6V with ±2% Accuracy at 25°C
- CMCOT™ Control Loop Design for Best Transient Response, Robust Loop Stability with Low-ESR (MLCC) C<sub>OUT</sub>
- Soft-Start 1.2ms; PGOOD Function in SOT-23-6

### Applications

- STB, Cable Modem, & xDSL Platforms
- LCD TV Power Supply & Metering Platforms
- General Purpose Point of Load (POL)

### Pin Configurations

(TOP VIEW)

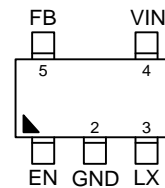

SOT-23-5

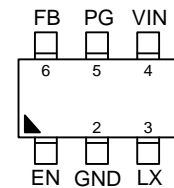

SOT-23-6

### Simplified Application Circuit

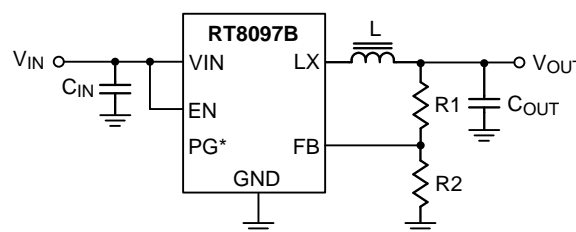

\*For SOT-23-6 Package Only

## Marking Information

RT8097BHGB

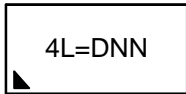

4L= : Product Code  
DNN : Date Code

RT8097BHGE

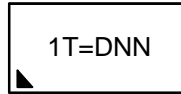

1T= : Product Code  
DNN : Date Code

RT8097BLGB

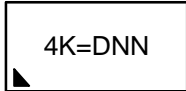

4K= : Product Code  
DNN : Date Code

RT8097BLGE

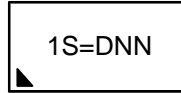

1S= : Product Code  
DNN : Date Code

## Functional Pin Description

Pin No.		Pin Name	Pin Function
SOT-23-5	SOT-23-6		
1	1	EN	Enable Control Input.
2	2	GND	Power Ground.
3	3	LX	Switch Node.
4	4	VIN	Supply Voltage Input. The RT8097B operates from a 2.7V to 6V input.
5	6	FB	Feedback Voltage Input. An external resistor divider from the output to GND, tapped to the FB pin, sets the output voltage.
--	5	PG	Power Good Indicator. The output of this pin is an open-drain with external pull-up resistor. PG is pulled up when the FB voltage is within 90%, otherwise it is LOW.

**Function Block Diagram**

For SOT-23-5 Package

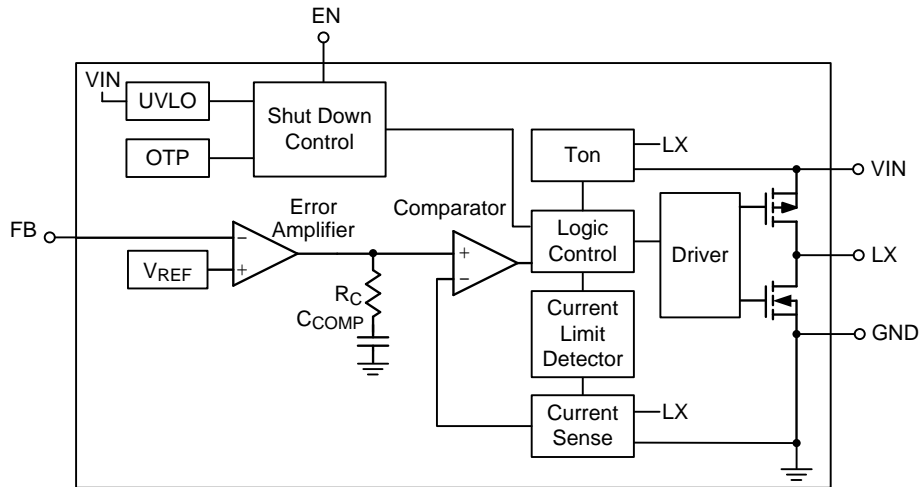

For SOT-23-6 Package

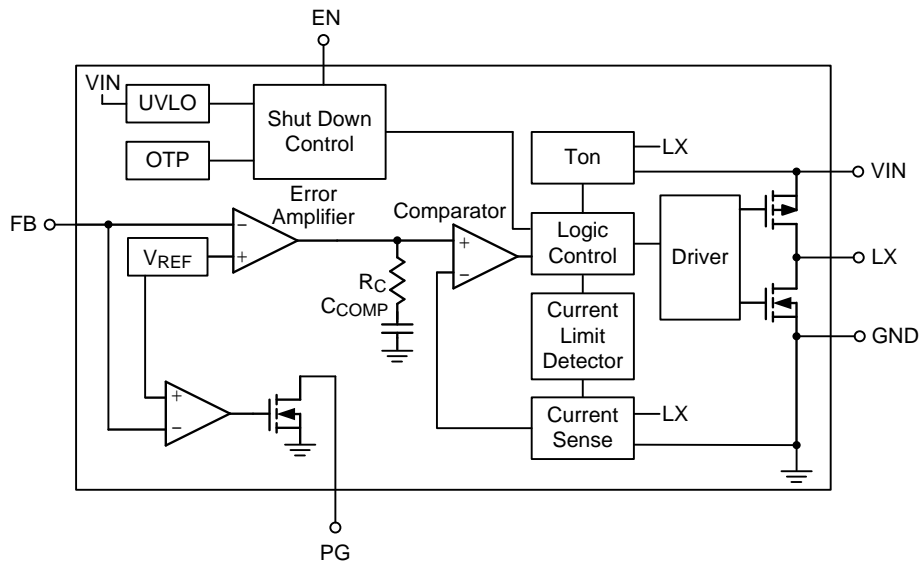

## Operation

The RT8097B is a synchronous low voltage step-down converter that can support the input voltage range from 2.7V to 6V and the output current can be up to 2A. The RT8097B uses a constant on-time, current mode architecture. In normal operation, the high side P-MOSFET is turned on when the switch controller is set by the comparator and is turned off when the Ton comparator resets the switch controller.

Low side MOSFET peak current is measured by internal RSENSE. The error amplifier EA adjusts COMP voltage by comparing the feedback signal ( $V_{FB}$ ) from the output voltage with the internal 0.6V reference. When the load current increases, it causes a drop in the feedback voltage relative to the reference, then the COMP voltage rises to allow higher inductor current to match the load current.

### UV Comparator

If the feedback voltage ( $V_{FB}$ ) is lower than threshold voltage 0.2V, the UV comparator's output will go high and the switch controller will turn off the high side MOSFET. The output under voltage protection is designed to operate in Hiccup mode for RT8097BH, Latch mode for RT8097BL.

### PGOOD Comparator

When the feedback voltage ( $V_{FB}$ ) is higher than threshold voltage 0.54V, the PGOOD open drain output will be high impedance. The internal PG MOSFET is typical 100 $\Omega$ . The PGOOD signal delay time from EN is about 2ms.

### Enable Comparator

A logic-high enables the converter; a logic-low forces the IC into shutdown mode.

### Soft-Start (SS)

An internal current source charges an internal capacitor to build the soft-start ramp voltage. The  $V_{FB}$  voltage will track the internal ramp voltage during soft-start interval. The typical soft-start time is 1.2ms.

### Over Current Protection (OCP)

The RT8097B provides over current protection by detecting low side MOSFET valley inductor current. If the sensed valley inductor current is over the current limit threshold (3.1A typ.), the OCP will be triggered. When OCP is tripped, the RT8097B will keep the over current threshold level then cause the UV protection.

### Thermal Shutdown (OTP)

The device implements an internal thermal shutdown function when the junction temperature exceeds 150°C. The thermal shutdown forces the device to stop switching when the junction temperature exceeds the thermal shutdown threshold. Once the die temperature decreases below the hysteresis of 20°C, the device reinstates the power up sequence.

**Absolute Maximum Ratings** (Note 1)

- Supply Input Voltage ----- -0.3V to 6.5V
- LX Pin Switch Voltage----- -0.3V to (V<sub>IN</sub> + 0.3V)  
     <20ns----- -4.5V to 7.5V
- Power Dissipation, P<sub>D</sub> @ T<sub>A</sub> = 25°C  
     SOT-23-5----- 0.45W  
     SOT-23-6----- 0.48W
- Package Thermal Resistance (Note 2)  
     SOT-23-5, θ<sub>JA</sub>----- 218.1°C/W  
     SOT-23-6, θ<sub>JA</sub>----- 208.2°C/W  
     SOT-23-5, θ<sub>JC</sub>----- 28.5°C/W  
     SOT-23-6, θ<sub>JC</sub>----- 32°C/W
- Lead Temperature (Soldering, 10 sec.)----- 260°C
- Junction Temperature----- -40°C to 150°C
- Storage Temperature Range----- -65°C to 150°C
- ESD Susceptibility (Note 3)  
     HBM (Human Body Model) ----- 2kV

**Recommended Operating Conditions** (Note 4)

- Supply Input Voltage ----- 2.7V to 6V
- Ambient Temperature Range----- -40°C to 85°C
- Junction Temperature Range ----- -40°C to 125°C

**Electrical Characteristics**

(V<sub>IN</sub> = 3.6V, T<sub>A</sub> = 25°C, unless otherwise specified)

Parameter	Symbol	Test Conditions	Min	Typ	Max	Unit
Input Voltage	V <sub>IN</sub>		2.7	--	6	V
Feedback Reference Voltage	V <sub>REF</sub>		0.588	0.6	0.612	V
Feedback Leakage Current	I <sub>FB</sub>	V <sub>FB</sub> = 3.3V	--	--	1	μA
DC Bias Current		Active , V <sub>FB</sub> = 0.63V, Not Switching	--	300	--	μA
		Shutdown	--	--	1	
Switching Leakage Current			--	--	1	μA
Switching Frequency			0.8	1	1.2	MHz
Switch On Resistance, Low	R <sub>NMOS</sub>	I <sub>SW</sub> = 0.3A	--	70	--	mΩ
Switch On Resistance, High	R <sub>PMOS</sub>	I <sub>SW</sub> = 0.3A	--	100	--	mΩ
Valley Current Limit	I <sub>LIM</sub>		2.2	3.1	3.9	A
Under-Voltage Lockout Threshold	V <sub>UVLO</sub>	VDD Rising	--	2.25	2.5	V
		VDD Falling	--	2	--	V

Parameter		Symbol	Test Conditions	Min	Typ	Max	Unit
Over-Temperature Threshold				--	150	--	°C
Enable Input Voltage	Logic-High	V <sub>IH</sub>		1.5	--	--	V
	Logic-Low	V <sub>IL</sub>		--	--	0.4	
PG Pin Threshold (relative to V <sub>OUT</sub> )			Rising	--	90	--	%
			Falling	--	85	--	
PG Open-Drain Impedance (PG = low)				--	--	100	Ω
Soft-Start Time		T <sub>SS</sub>		--	1.2	--	ms
Minimum Off Time				70	120	180	ns
Output Discharge Switch On Resistance				--	1.8	--	kΩ

**Note 1.** Stresses beyond those listed “Absolute Maximum Ratings” may cause permanent damage to the device. These are stress ratings only, and functional operation of the device at these or any other conditions beyond those indicated in the operational sections of the specifications is not implied. Exposure to absolute maximum rating conditions may affect device reliability.

**Note 2.**  $\theta_{JA}$  is measured at T<sub>A</sub> = 25°C on a high effective thermal conductivity four-layer test board per JEDEC 51-7. The first layer of copper area is filled.  $\theta_{JC}$  is measured at the lead of the package.

**Note 3.** Devices are ESD sensitive. Handling precaution recommended.

**Note 4.** The device is not guaranteed to function outside its operating conditions.

**Typical Application Circuit**

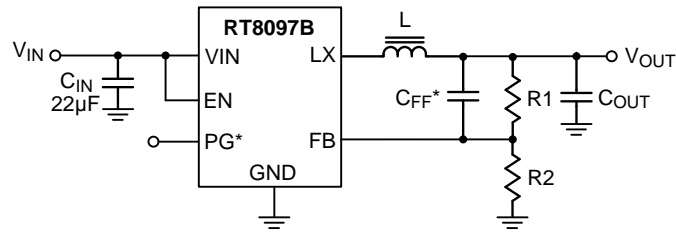

\*For SOT-23-6 Package Only

\*CFF : Optional for performance fine-tune

**Table 1. Suggested Component Values**

V <sub>OUT</sub> (V)	R1 (kΩ)	R2 (kΩ)	C <sub>IN</sub> (µF)	L (µH)	C <sub>OUT</sub> (µF)
3.3	90	20	22	1.5	22
1.8	100	50	22	1.5	22
1.5	100	66.6	22	1.5	22
1.2	100	100	22	1.5	22
1.05	100	133	22	1.5	22
1	100	148	22	1.5	22

Typical Operating Characteristics

Efficiency vs. Output Current

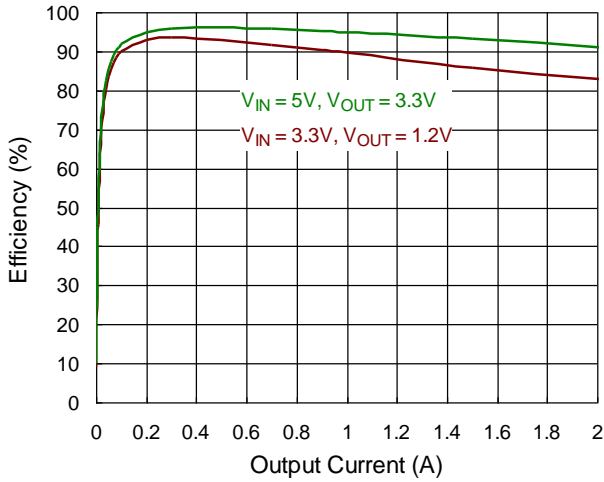

Efficiency vs. Output Current

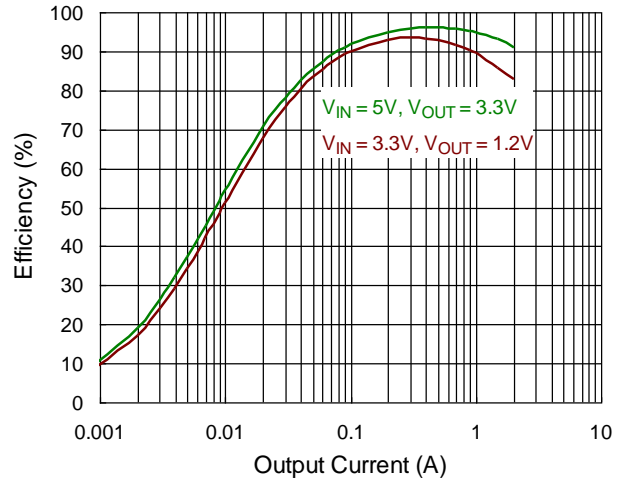

Output Voltage vs. Output Current

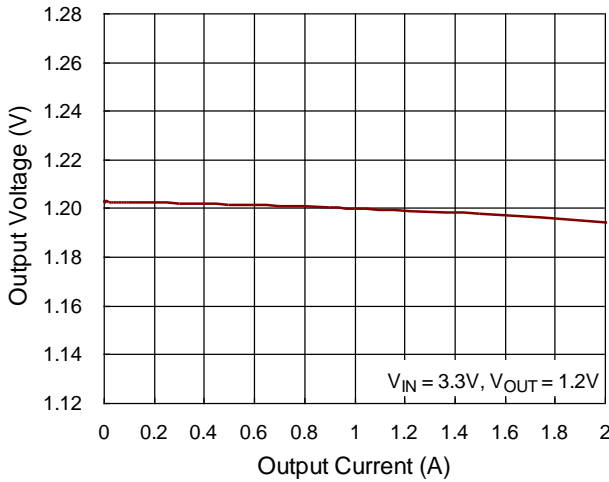

Output Voltage vs. Output Current

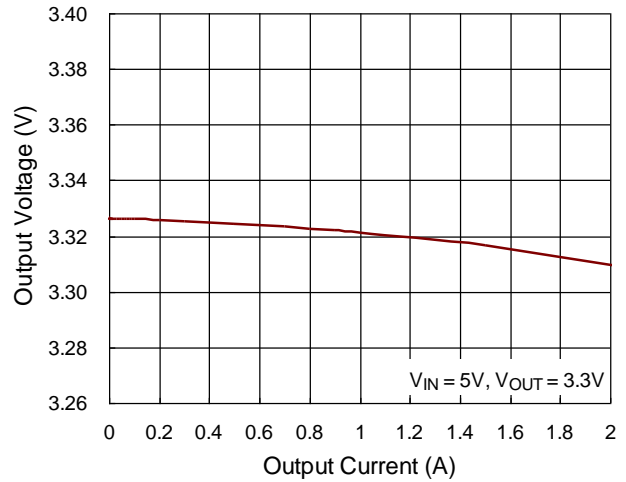

Output Voltage vs. Input Voltage

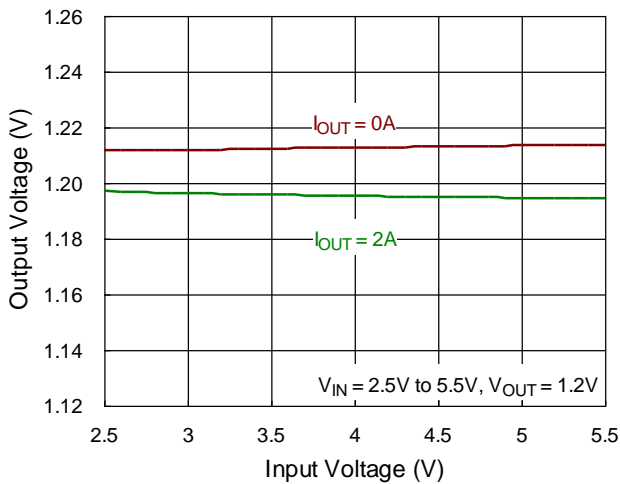

Output Voltage vs. Input Voltage

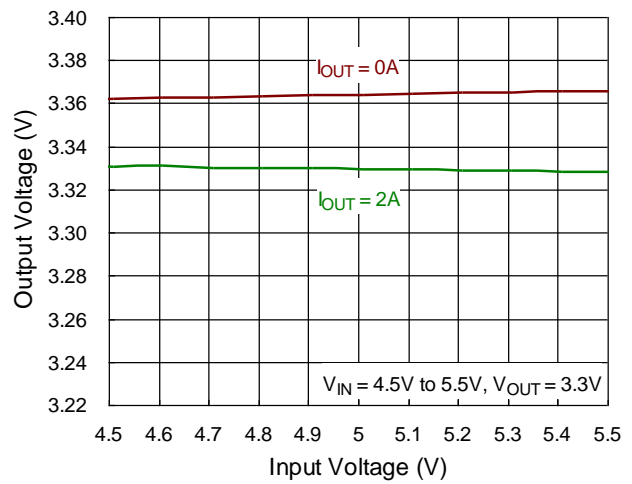



**Reference Voltage vs. Input Voltage**

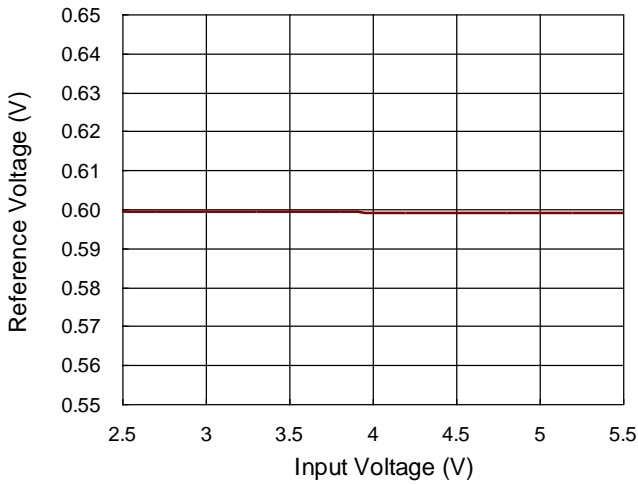

**Switching Frequency vs. Input Voltage**

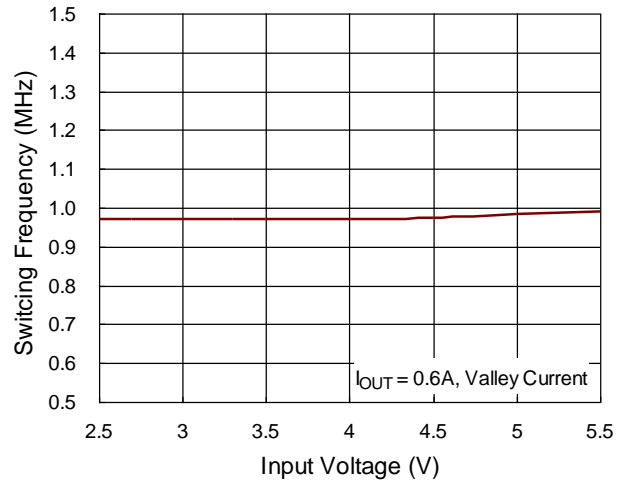

**Shutdown Current vs. Input Voltage**

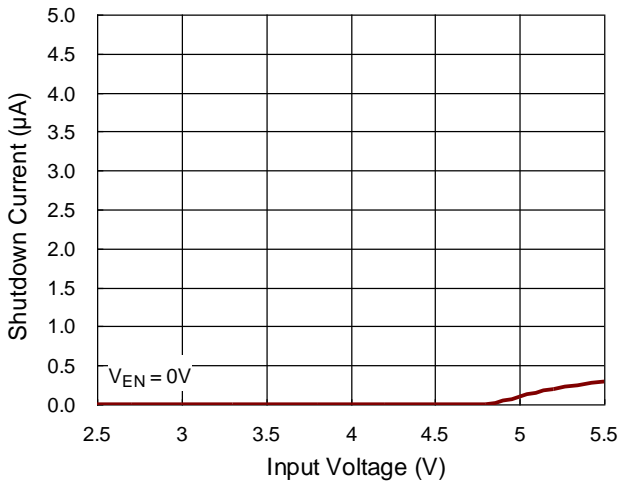

**Shutdown Current vs. Temperature**

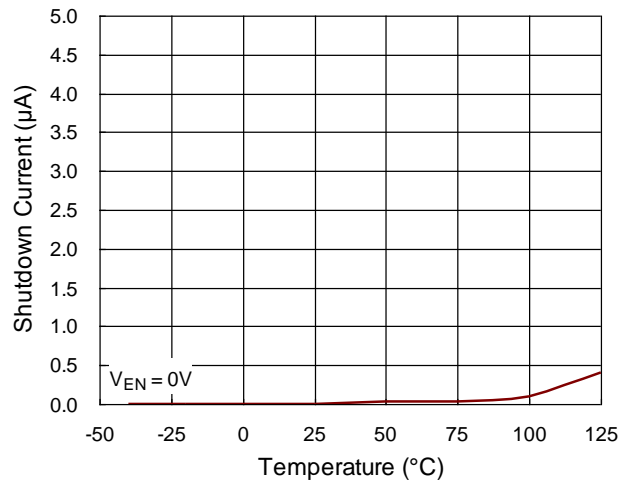

**Quiescent Current vs. Input Voltage**

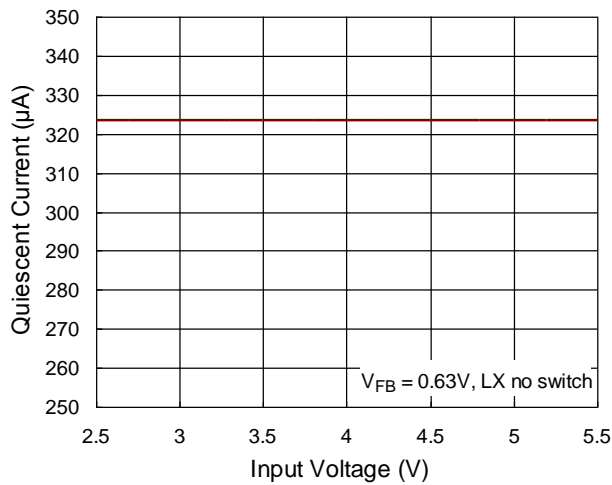

**Quiescent Current vs. Temperature**

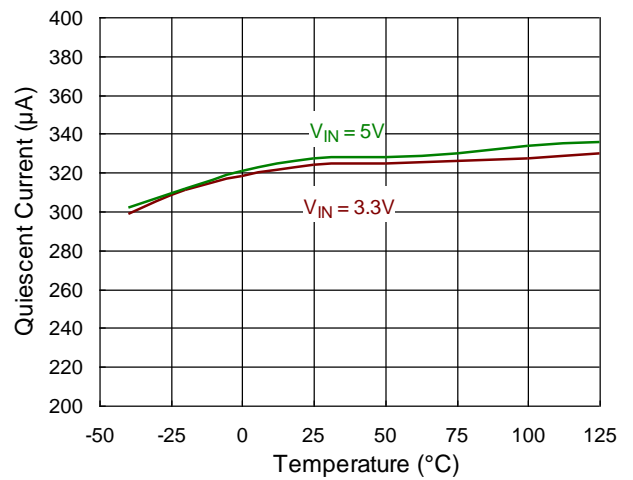

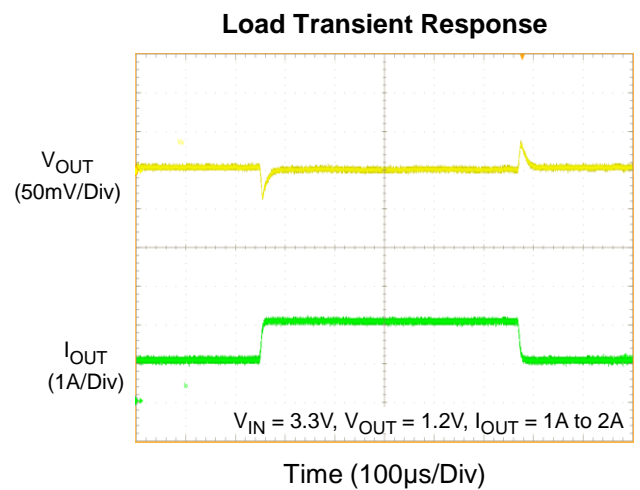
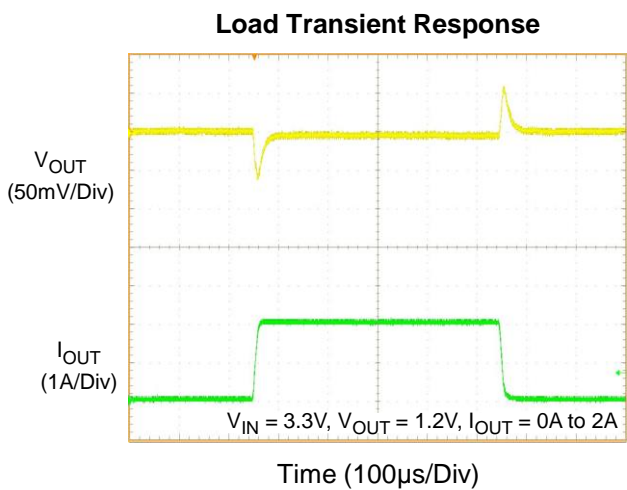
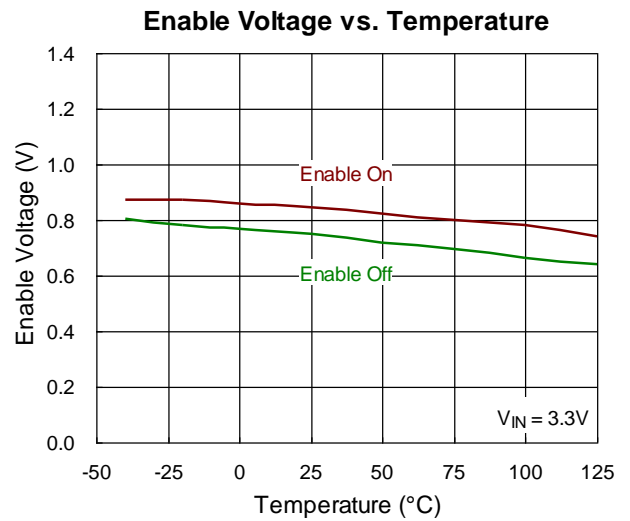
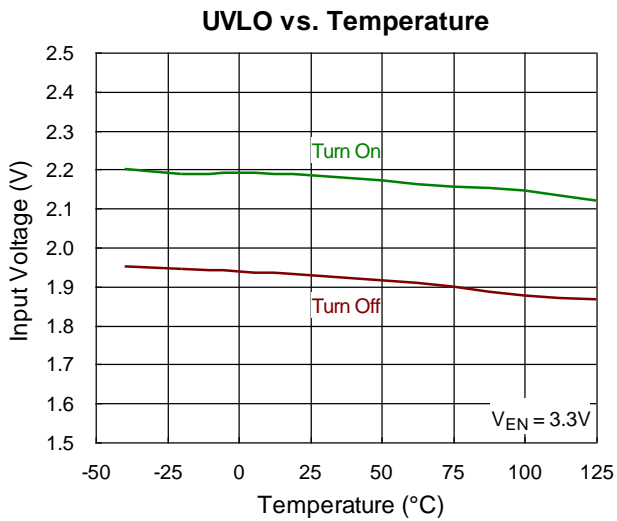
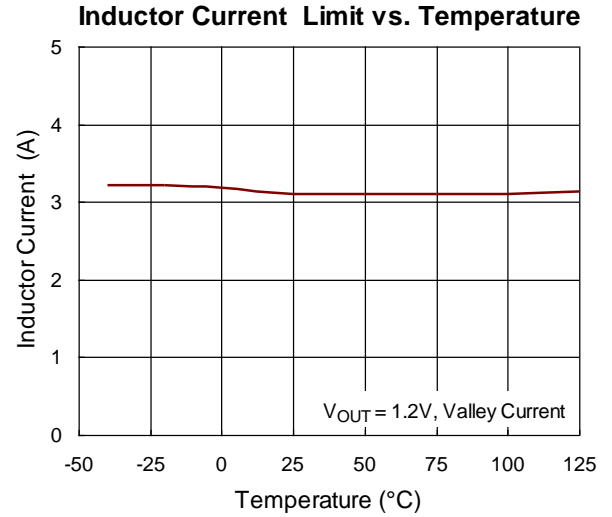
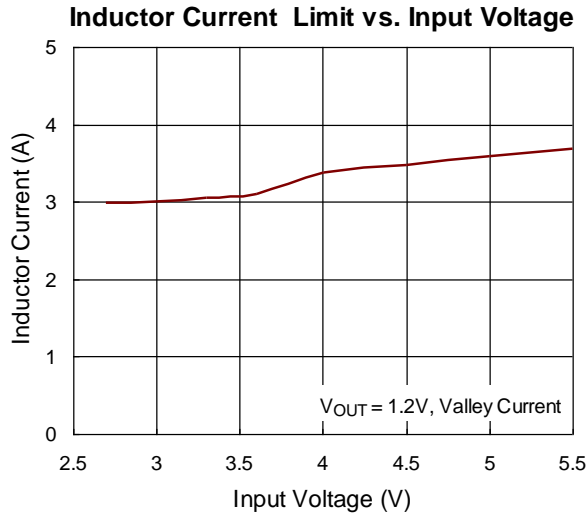

**Voltage Ripple**

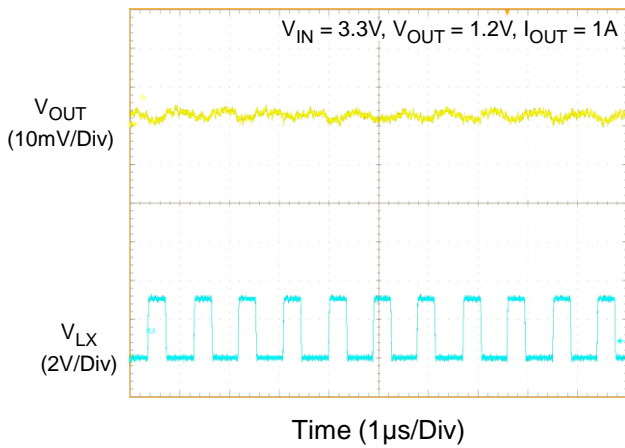

**Voltage Ripple**

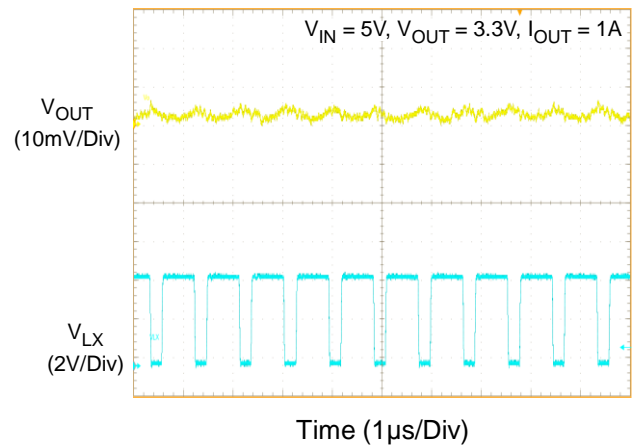

**Power On from EN**

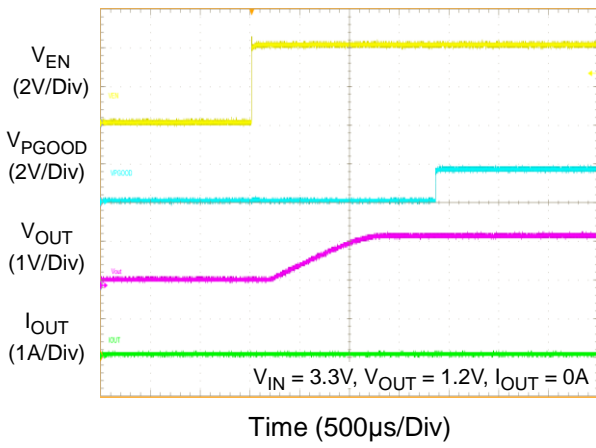

**Power Off from EN**

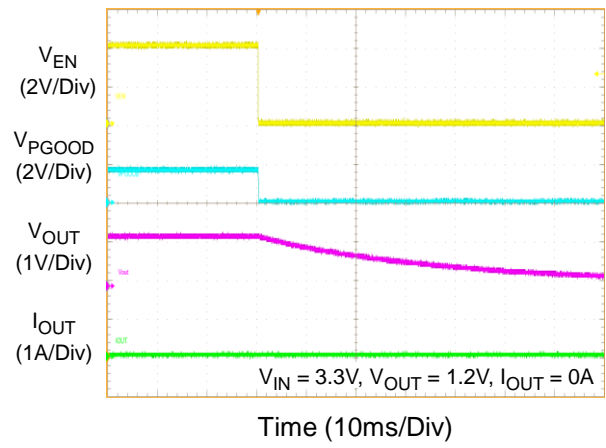

## Application Information

The RT8097B is a single-phase step-down converter. It provides single feedback loop constant on-time, current mode control with fast transient response. An internal 0.6V reference allows the output voltage to be precisely regulated for low output voltage applications. A fixed switching frequency (1MHz) oscillator and internal compensation are integrated to minimize external component count. Protection features include over current protection, under voltage protection and over temperature protection.

### Output Voltage Setting

Connect a resistive voltage divider at the FB between  $V_{OUT}$  and GND to adjust the output voltage. The output voltage is set according to the following equation :

$$V_{OUT} = V_{REF} \times \left(1 + \frac{R1}{R2}\right)$$

where  $V_{REF}$  is the feedback reference voltage 0.6V (typ.).

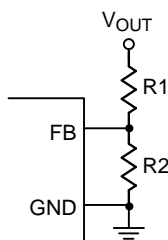

Figure 1. Setting  $V_{OUT}$  with a Voltage Divider

### Chip Enable and Disable

The EN pin allows for power sequencing between the controller bias voltage and another voltage rail. The RT8097B remains in shutdown if the EN pin is lower than 400mV. When the EN pin rises above the  $V_{EN}$  trip point, the RT8097B begins a new initialization and soft-start cycle.

### Internal Soft-Start

The RT8097B provides an internal soft-start function to prevent large inrush current and output voltage overshoot when the converter starts up. The soft-start (SS) automatically begins once the chip is enabled. During soft-start, the internal soft-start capacitor becomes charged and generates a linear ramping up voltage across the capacitor. This voltage

clamps the voltage at the FB pin, causing PWM pulse width to increase slowly and in turn reduce the input surge current. The internal 0.6V reference takes over the loop control once the internal ramping-up voltage becomes higher than 0.6V.

### Over Voltage Protection (OVP)

The RT8097BL provide Over Voltage Protection function when output voltage over 120%. The IC will be into Latch-off mode.

### UVLO Protection

The RT8097BL has input Under Voltage Lockout protection (UVLO). If the input voltage exceeds the UVLO rising threshold voltage (2.25V typ.), the converter resets and prepares the PWM for operation. If the input voltage falls below the UVLO falling threshold voltage during normal operation, the device will stop switching. The UVLO rising and falling threshold voltage has a hysteresis to prevent noise-caused reset.

### Input Capacitor Selection

High quality ceramic input decoupling capacitor, such as X5R or X7R, with values greater than 22 $\mu$ F are recommended for the input capacitor. The X5R and X7R ceramic capacitors are usually selected for power regulator capacitors because the dielectric material has less capacitance variation and more temperature stability.

Voltage rating and current rating are the key parameters when selecting an input capacitor. Generally, selecting an input capacitor with voltage rating 1.5 times greater than the maximum input voltage is a conservatively safe design.

The input capacitor is used to supply the input RMS current, which can be approximately calculated using the following equation :

$$I_{IN\_RMS} = I_{LOAD} \times \sqrt{\frac{V_{OUT}}{V_{IN}} \times \left(1 - \frac{V_{OUT}}{V_{IN}}\right)}$$

The next step is selecting a proper capacitor for RMS current rating. One good design uses more than one capacitor with low equivalent series resistance (ESR) in parallel to form a capacitor bank.

The input capacitance value determines the input ripple voltage of the regulator. The input voltage ripple can be approximately calculated using the following equation :

$$\Delta V_{IN} = \frac{I_{OUT(MAX)}}{C_{IN} \times f_{SW}} \times \frac{V_{OUT}}{V_{IN}} \times \left(1 - \frac{V_{OUT}}{V_{IN}}\right)$$

### Output Capacitor Selection

The output capacitor and the inductor form a low pass filter in the Buck topology. In steady state condition, the ripple current flowing into/out of the capacitor results in ripple voltage. The output voltage ripple ( $V_{P-P}$ ) can be calculated by the following equation :

$$V_{P-P} = LIR \times I_{LOAD(MAX)} \times \left(ESR + \frac{1}{8 \times C_{OUT} \times f_{SW}}\right)$$

When load transient occurs, the output capacitor supplies the load current before the controller can respond. Therefore, the ESR will dominate the output voltage sag during load transient. The output voltage undershoot ( $V_{SAG}$ ) can be calculated by the following equation :

$$V_{SAG} = \Delta I_{LOAD} \times ESR$$

For a given output voltage sag specification, the ESR value can be determined.

Another parameter that has influence on the output voltage sag is the equivalent series inductance (ESL). The rapid change in load current results in di/dt during transient. Therefore, the ESL contributes to part of the voltage sag. Using a capacitor with low ESL can obtain better transient performance. Generally, using several capacitors connected in parallel can have better transient performance than using a single capacitor for the same total ESR.

### Inductor Selection

The switching frequency (on-time) and operating point (% ripple or LIR) determine the inductor value as shown below :

$$L = \frac{V_{OUT} \times (V_{IN} - V_{OUT})}{f_{SW} \times LIR \times I_{LOAD(MAX)} \times V_{IN}}$$

where LIR is the ratio of the peak-to-peak ripple current to the average inductor current.

Find a low loss inductor having the lowest possible DC resistance that fits in the allotted dimensions. The core

must be large enough not to saturate at the peak inductor current ( $I_{PEAK}$ ) :

$$I_{PEAK} = I_{LOAD(MAX)} + \left(\frac{LIR}{2} \times I_{LOAD(MAX)}\right)$$

The calculation above serves as a general reference. To further improve transient response, the output inductor can be further reduced. This relation should be considered along with the selection of the output capacitor.

Inductor saturation current should be chosen over IC's current limit.

### Thermal Considerations

For continuous operation, do not exceed absolute maximum junction temperature. The maximum power dissipation depends on the thermal resistance of the IC package, PCB layout, rate of surrounding airflow, and difference between junction and ambient temperature. The maximum power dissipation can be calculated by the following formula :

$$P_{D(MAX)} = (T_{J(MAX)} - T_A) / \theta_{JA}$$

where  $T_{J(MAX)}$  is the maximum junction temperature,  $T_A$  is the ambient temperature, and  $\theta_{JA}$  is the junction to ambient thermal resistance.

For recommended operating condition specifications, the maximum junction temperature is 125°C. The junction to ambient thermal resistance,  $\theta_{JA}$ , is layout dependent. For SOT-23-5 package, the thermal resistance,  $\theta_{JA}$ , is 218.1°C/W on a standard four-layer thermal test board. For SOT-23-6 package, the thermal resistance,  $\theta_{JA}$ , is 208.2°C/W on a standard four-layer thermal test board. The maximum power dissipation at  $T_A = 25^\circ\text{C}$  can be calculated by the following formula :

$$P_{D(MAX)} = (125^\circ\text{C} - 25^\circ\text{C}) / (218.1^\circ\text{C/W}) = 0.45\text{W for SOT-23-5 package}$$

$$P_{D(MAX)} = (125^\circ\text{C} - 25^\circ\text{C}) / (208.2^\circ\text{C/W}) = 0.48\text{W for SOT-23-6 package}$$

The maximum power dissipation depends on the operating ambient temperature for fixed  $T_{J(MAX)}$  and thermal resistance,  $\theta_{JA}$ . The derating curve in Figure 2 allows the designer to see the effect of rising ambient temperature on the maximum power dissipation.

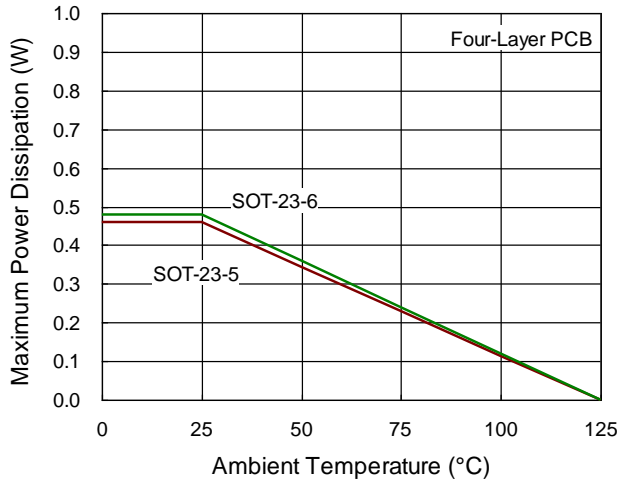
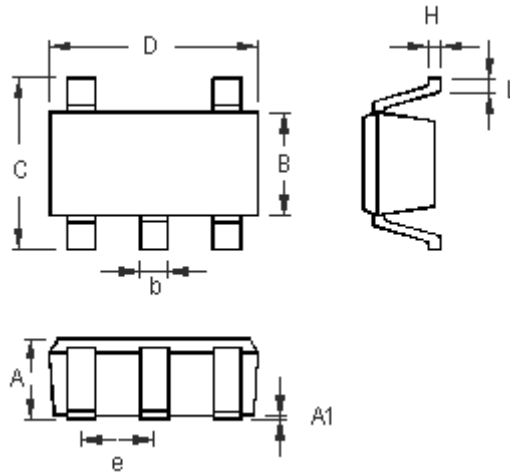

Figure 2. Derating Curve of Maximum Power Dissipation

**Outline Dimension**



Symbol	Dimensions In Millimeters		Dimensions In Inches	
	Min	Max	Min	Max
A	0.889	1.295	0.035	0.051
A1	0.000	0.152	0.000	0.006
B	1.397	1.803	0.055	0.071
b	0.356	0.559	0.014	0.022
C	2.591	2.997	0.102	0.118
D	2.692	3.099	0.106	0.122
e	0.838	1.041	0.033	0.041
H	0.080	0.254	0.003	0.010
L	0.300	0.610	0.012	0.024

**SOT-23-5 Surface Mount Package**

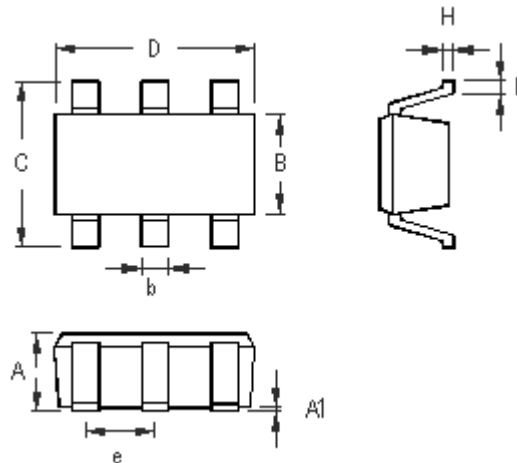

Symbol	Dimensions In Millimeters		Dimensions In Inches	
	Min	Max	Min	Max
A	0.889	1.295	0.031	0.051
A1	0.000	0.152	0.000	0.006
B	1.397	1.803	0.055	0.071
b	0.250	0.560	0.010	0.022
C	2.591	2.997	0.102	0.118
D	2.692	3.099	0.106	0.122
e	0.838	1.041	0.033	0.041
H	0.080	0.254	0.003	0.010
L	0.300	0.610	0.012	0.024

SOT-23-6 Surface Mount Package

**Richtek Technology Corporation**

14F, No. 8, Tai Yuen 1<sup>st</sup> Street, Chupei City  
 Hsinchu, Taiwan, R.O.C.  
 Tel: (8863)5526789

Richtek products are sold by description only. Richtek reserves the right to change the circuitry and/or specifications without notice at any time. Customers should obtain the latest relevant information and data sheets before placing orders and should verify that such information is current and complete. Richtek cannot assume responsibility for use of any circuitry other than circuitry entirely embodied in a Richtek product. Information furnished by Richtek is believed to be accurate and reliable. However, no responsibility is assumed by Richtek or its subsidiaries for its use; nor for any infringements of patents or other rights of third parties which may result from its use. No license is granted by implication or otherwise under any patent or patent rights of Richtek or its subsidiaries.

Copyright © 2016 Richtek Technology Corporation. All rights reserved. **RICHTEK** is a registered trademark of Richtek Technology Corporation.



## X-ON Electronics

Largest Supplier of Electrical and Electronic Components

*Click to view similar products for [Richtek](#) manufacturer:*

Other Similar products are found below :

[EVB\\_RT5047GSP](#) [EVB\\_RT7275GQW](#) [EVB\\_RT7297CHZSP](#) [RT9080N-08GJ5](#) [EVB\\_RT5047AGSP](#) [EVB\\_RT7243GQW](#)  
[EVB\\_RT7272BGSP](#) [RT8097AHGE](#) [EVB\\_RT7247CHGSP](#) [EVB\\_RT7276GQW](#) [EVB\\_RT8293AHZSP](#) [EVB\\_RT6200GE](#)  
[EVB\\_RT7235GQW](#) [EVB\\_RT7237AHGSP](#) [EVB\\_RT7251AZQW](#) [RT5047AGSP](#) [EVB\\_RT7272AGSP](#) [EVB\\_RT7237CHGSP](#)  
[EVB\\_RT7247AHGSP](#) [EVB\\_RT7252BZSP](#) [EVB\\_RT7280GQW](#) [EVB\\_RT8292AHZSP](#) [EVB\\_RT8297BZQW](#) [EVB\\_RT7231GQW](#)  
[EVB\\_RT7232GQW](#) [EVB\\_RT7236GQW](#) [EVB\\_RT7250BZSP](#) [EVB\\_RT7251BZQW](#) [EVB\\_RT7279GQW](#) [EVB\\_RT8008GB](#) [RT8207MZQW](#)  
[RT8296AHZSP](#) [RT9011-JGPJ6](#) [RT8258GE](#) [RT5711AHGQW](#) [RT9081AGQZA\(2\)](#) [RT6154BGQW](#) [RT7238BGQUF](#) [RT5788AGJ8F](#)  
[RT8812AGQW](#) [RT6278BHGQUF](#) [RT7270HZSP](#) [RD0004](#) [RT5789AGQUF](#) [RT9076-18GVN](#) [RT9193-15GU5](#) [RT3602AJGQW](#)  
[RT8296BHZSP](#) [RT6214AHGJ6F](#) [RT9276GQW\(Z00\)](#)